

2015 PRICE LIST **CASEGOODS VISION**



EFFECTIVE 15 OCTOBER 2015

**Effective November 1, 2016**

**5.0%**

Price Increase on JSI 2015 Price Lists:  
Casegood (V1, V2, V3), Conference, and Seating

List Prices reflect price increase

## Casegoods Price List - Volume 2 | Vision Series

### General Information

Environmental Mission . . . . .	2
Warranty. . . . .	3
Laminate and Veneer Characteristics . . . . .	3
Samples. . . . .	4
Order Procedures . . . . .	4
Quickship Program. . . . .	4
Delivery . . . . .	4
Freight Damage . . . . .	5
Repairs and Returns . . . . .	5
Care and Maintenance. . . . .	5
Textile Information . . . . .	6
COM and COL Policy . . . . .	6
Guide Order Form for COM and COL . . . . .	7

### Textile and Leather Swatch Card Programs

Maharam . . . . .	8
Momentum . . . . .	9-11
Ultraleather . . . . .	11
Wollsdorf . . . . .	11

### Fabric Grading

Arc-Com. . . . .	12
Designtex . . . . .	13
Maharam . . . . .	14
Mayer . . . . .	15
Momentum . . . . .	16
Pallas . . . . .	17
Stinson . . . . .	18
Ultrafabrics . . . . .	19

### Leather Grading

Wollsdorf . . . . .	20
---------------------	----

### Specification Tools . . . . . 21

### GSA Terms and Conditions . . . . . 22

### Vision Casegoods - Volume 2

<b>Vision Laminate</b> . . . . .	27
Desks . . . . .	62
Modesty Panels . . . . .	65
Peninsula Desks . . . . .	73
Desk Bases . . . . .	75
Returns . . . . .	76
Bridges . . . . .	86
Credenzas . . . . .	88
Modular Tops . . . . .	92
Modular Supports . . . . .	92
Modular Pedestals. . . . .	97
Support Applications. . . . .	98
Modesty Panel Applications . . . . .	100
Overhead Cabinets. . . . .	102
Overhead Cabinet Post Supports . . . . .	138
Tackboards . . . . .	116
Accessories . . . . .	128
Wall Mount Storage . . . . .	149
Overhead Bookcases . . . . .	168
Storage Tower Applications . . . . .	169
Overhead Bridge Storage. . . . .	174
Transaction Applications . . . . .	178
Bench Height Applications . . . . .	179
Freestanding Bench Height Cabinets . . . . .	182
Modular Bench Height Cabinets . . . . .	190
Modular Tops . . . . .	192
Bench Height Seat Cushions . . . . .	194
Bookcases. . . . .	196
Lateral Files . . . . .	198
Wardrobes. . . . .	200
Storage Cabinets . . . . .	202
Privacy Screens . . . . .	213

<b>Vision Veneer</b> . . . . .	217
Desks . . . . .	252
Modesty Panels . . . . .	255
Peninsula Desks . . . . .	263
Desk Bases . . . . .	265
Returns . . . . .	266
Bridges . . . . .	276
Credenzas . . . . .	278
Modular Tops . . . . .	282
Modular Supports . . . . .	282
Modular Pedestals. . . . .	287
Support Applications. . . . .	288
Modesty Panel Applications . . . . .	290
Overhead Cabinets. . . . .	292
Overhead Cabinet Post Supports . . . . .	328
Tackboards . . . . .	306
Accessories . . . . .	318
Wall Mount Storage . . . . .	339
Overhead Bookcases . . . . .	358
Storage Tower Applications . . . . .	359
Overhead Bridge Storage. . . . .	364
Transaction Applications . . . . .	368
Bench Height Applications . . . . .	369
Freestanding Bench Height Cabinets . . . . .	372
Modular Bench Height Cabinets . . . . .	380
Modular Tops . . . . .	382
Bench Height Seat Cushions . . . . .	384
Bookcases. . . . .	386
Lateral Files . . . . .	388
Wardrobes. . . . .	390
Storage Cabinets . . . . .	392
Privacy Screens . . . . .	403
<b>Accessories</b> . . . . .	407
Casegoods Power and Data . . . . .	409
Casegoods Task Lights . . . . .	412
Casegoods Keyboard Accessories . . . . .	414
<b>Index</b> . . . . .	416

JSI Casegoods pricing is divided into three Price List Volumes:  
Volume 1 - Contemporary/Transitional  
Volume 2 - Vision Series  
Volume 3 - Traditional

**Contemporary/Transitional Casegoods - Volume 1**  
Apogee  
Broadway  
Collective Office  
Finale  
iXY  
Shuffle

**Traditional Casegoods - Volume 3**  
Brogan  
Walden  
Wellington

## Environmental Mission

Our vision and goal is a sustaining supplier, manufacturer and customer for the long term protection and preservation of our environment for future generations.

### MISSION

To achieve this vision, we are dedicated to ensuring the health and wellbeing of all of our partners, reducing negative impact on the environment, and maintaining price structure by increasing efficiencies and reducing consumption.

The Jasper Group family of brands, including JSI, is an international manufacturer that has been an environmentally conscious organization for more than 80 years.

We are proud to use wood as our primary sustainable material resource and all corporate policies and procedures support the efforts to “recover, recycle, reuse, repurpose, reduce, refuse, and re-engineer”. In doing this, we are committed to the conservation of the environment and its natural resources as well as encouraging our suppliers and customers to do the same. A goal of a “Sustainable Partnership”, supplier, manufacturer and customer, is essential for the long term protection preservation and sustainability of our environment for future generations.

### LOCATION

Our manufacturing facilities are located in Southern Indiana. With our diverse product offering and manufacturing capabilities, we provide a single source for all of your project needs allowing you to conserve our fossil fuels and reduce greenhouse gases.

### PACKAGING

We place emphasis on the minimal use of disposable packaging while still providing adequate protection to the finished product. Our corrugated packaging is recyclable, reusable, and up to 100% recycled content. We reuse or recycle more than 125 tons of corrugated material annually.

### REGULATORY

All of our manufacturing facilities are in compliance with applicable OSHA regulations and meet or exceed all applicable DEM and EPA regulations for air emissions, storm water and hazardous waste disposal.

### MANUFACTURING FACILITIES

Our manufacturing facilities are geared toward eco-efficiency and are encouraged to continually improve and conserve. Solid wood not used in the direct manufacturing process is recovered for the operation of our dry kilns, thus reducing greenhouse gases, the use of fossil fuels, and the burden of waste placed on landfills. Composite panels not used in the direct manufacturing process are ground and sold for use as animal bedding. In addition to other energy savings techniques, our manufacturing facilities use high efficient lighting, make use of power factor capacitors, and encourage all to conserve and reduce energy consumption and water usage. Condensation pumps are used to aid in water conservation as well as extending boiler life.

### MANUFACTURING PROCESSES

Our finish processes utilize efficient spray guns and proper spray techniques to reduce wasted material. Excess finish material, solvents, and waste are recycled. Many of the assembly processes use water based glues that contain no hazardous ingredients.

### TEXTILES

Many of our fabric options utilize up to 100% recycled content. Our leather alternative program includes selections that contain no toxic materials, plasticizers, heavy metals, or formaldehyde and have a 100% biodegradable back cloth. Some of the available panel fabric used, if discarded is a biological nutrient for the soil. Most of the components (foam, batting, and polycord) used in upholstered products are recyclable and contain various percentages of recycled content. Excess fabrics and leathers not utilized in the upholstery process go to recyclers and local charities for additional use.

### WOOD

Wood is the most diverse, most process friendly, and most widely utilized natural resource in mankind’s history. No other natural resource can match the environmental advantages of wood, including being renewable, recyclable, natural, carbon negative, and biodegradable. Utilizing the sun’s energy, trees grow and remove carbon dioxide from the air while giving off oxygen to benefit the entire planet. Approximately 49% of wood’s dry weight is carbon and harvesting mature trees in a sustainable forest, which has slowed in the absorption of carbon dioxide, allows the photosynthetic cycle to continue at full optimization and allow for the carbon to remain sequestered. We are proud to use wood as our primary “sustainable” renewable resource.

### WOOD OPTIONS

Many environmentally friendly solid wood and engineered wood options are available for quote, including: Lyptus®, Plyboo®, reclaimed woods, agricultural and post-consumer waste fiber products, soy-based resin bio-composites, etc.

### INDOOR AIR QUALITY

Our goal is to reduce the impact our products will have on the indoor air quality. We practice the latest technologies and utilize a third party to assure we meet this goal. GreenGuard, one of the leaders in IAQ certification, continues to certify our product offering, awarding us the UL2818 - GreenGuard Indoor Air Quality standard.

### PARNTERSHIPS

BIFMA  
*Business and Institutional Furniture Manufacturer Association*  
 USGBC  
*United States Green Building Council*  
 IIDA  
*International Interior Design Association*  
 FSC  
*Forest Stewardship Council*  
 GreenGuard

### Warranty (Casegoods)

JSI warrants, to the original purchaser that each piece of furniture will be free from defects in workmanship, given normal use for a period of fifteen (15) years of single shift service. Drawer suspensions carry a life time warranty. Fabric manufacturer's warranty will apply. Ergo mechanism and controls along with electrical items not manufactured by JSI are covered for a period of one (1) year. JSI will, at its option, repair or replace any defective merchandise with the terms of this warranty. ▲

JSI makes no expressed or implied warranties to any product and, in particular, makes no warranty of merchantability of fitness for any particular purpose.

This warranty does not cover:

- + Natural variations in color, texture of wood, and covering materials over which JSI has no control.
- + Damage created by bottom loading file drawers. File drawers are manufactured for hanging folders only.
- + Normal wear, color fastness, shrinkage, wrinkling, stretching of leather, and textiles.
- + Damage caused by transportation or installation companies.
- + Damage created by any accident, user modification, misuse of product, or neglect of product care.
- + Damage resulting from extreme climate conditions.

### Unique Characteristic of Natural Woods and Veneers

JSI uses high quality wood and veneer harvested from sustainably managed forests. Every tree has unique and defining characteristics, like fingerprints. These characteristics can be defined by differences in color, grain configuration, and textures. These characteristics will be more noticeable if the product has a clear or lighter finish.

Maple and Cherry species have a higher degree of uneven distribution of grain, small color streaks, and pin knots.

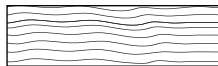
At JSI, we take care of selecting woods and veneers that are used in our products. With this in mind, we hope you appreciate the beauty of each tree's fingerprints. Products will not be replaced due to these natural characteristics.

Veneers can be sliced in a variety of ways to create unique patterns. JSI uses several different patterns, as shown below.

Flat (Plain) Cut as shown in diagram



Quarter Sliced as shown in diagram



Double Cut as shown in diagram



#### Double Cut

The Double Cut veneer is a processed product that has at least two cuttings to create the final veneers. These cuts of veneer strands are dyed and layered into a block to create variation of patterns from a very tight grain pattern to an exotic figure grain pattern.

JSI uses select beech, cherry, maple, oak and walnut cut wood products to produce the desired look of our furniture products.

Please reference the featured highlights of each product line to identify the species and grain patterns available for that product.

### Laminates (Veneer Series)

HPL (Higher Pressure Laminate) laminates can be specified on most of our work surface tops in most of our product lines. Refer to the specification pages for each series. The specification pages will also list the available coordinating finishes. HPL is .050 thick for maximum durability.

### Laminate Series

JSI laminate series offer a full laminated product with imprinted grain to hide finger prints and provide durability. The worksurface tops can be specified in either a matching HPL or TFL (Thermal Fused Laminate). TFL is used on the product's chassis. Please reference the featured highlights of each product for additional details.

### Finish - Top Coat

To reduce hazardous formaldehyde emissions, we use our proprietary specially designed top coat, DuraTex™. It significantly reduces hazardous formaldehyde emissions and helps improve indoor air quality.

### Finish - Color/Stains

A wide range of stains are available to bring out the beautiful characteristics of each wood species. We coordinate finish color between our veneer stains and solid lumber stains; however, not all may be a perfect match. The stains are continually reviewed for accuracy of color, as well as a constant monitoring of the latest color trends in the furniture market.

### Finish - Matching

Due to the natural characteristics of wood, environmental effects, and material upgrades, JSI cannot guarantee exact finish matches on existing furniture previously ordered.

If an exact match is required to accompany existing furniture, it must be specified at the time of order placement, so specific internal procedures can be followed to ensure a proper and acceptable finish match. We reserve the right to change our finish formula at any time to improve safety, quality, and appearance. Unless a finish match for existing furniture is requested at the time of ordering, we accept no liability for finish that may not match the existing furniture from prior orders.

Solid lumber may inherently have mineral streaks, pits, and various other natural occurrences. Care is taken in selecting the solid lumber to coordinate with the requested finish on our veneer products. This internal selection process is subject to availability of solid lumber parts.

### Custom/Special Finishes

JSI, upon request, will accommodate special finishes. A written request is required to proceed with custom finish orders. A sample reference is required for first time matches and must be included with the written request.

There is a one time charge of **\$289 list per order** for any non-standard wood finish.

Orders will be entered noting the special finish. A sample match will be provided to the customer. Written approval is needed before the finish process can be started. Delays in approval may have an impact on lead times.

Every effort will be made to create the requested match; however, an acceptable match may not be possible because of natural variations of wood. These natural variations can also cause minor differences in the final finish product.

### Samples

Samples of standard wood finishes, paints colors, metal colors, and standard laminate are available upon request. The fastest way for requests to be filled is by using our website. See below for options to request samples.

Website – jsifurniture.com (click the resource tab)  
 JSI Sales representatives  
 Phone – 800.457.4511 – Customer Service  
 Fax – 812.771.4652

### Pricing

Prices found in this document or on our website are list prices in U.S. dollars for standard product delivery to one destination. Prices do not include storage, installation, or taxes. Possession of this price list does not constitute an offer to sell. Orders can only be received from approved authorized JSI dealers.

Prices and product information in this document, as well as our website, are subject to change without notice. Reference website for most up to date product offering and pricing.

### Orders

Detailed specification pages are available in the price list at the beginning of each series.

Additional information may be obtained by consulting the Customer Service Department or our website.

Indicate shipping address if different from billing address.

Send Orders To:

US Mail – JSI  
 225 Clay Street  
 Jasper, IN 47546  
 Fax – 812-482-1548  
 Email – orders@jaspergroup.us.com

JSI reserves the right to make changes in dimensions, styles, or specifications if we believe these changes will improve the safety, quality, or appearance of the product.

Acceptance of orders will be subject to credit approval, barring any acts of governments, or any other causes beyond our control (e.g. strikes, fire, embargo of materials, etc).

### Product Modifications

While we offer a wide range of products to accommodate many possible solutions, we also recognize the needs for our products to be modified from our standard offering.

In the series introduction section of each product, we address modification options for that series.

To see if the desired modification is possible, please contact our Customer Service Department for a quote. Note that order quantities and material availability can affect the quote. Additional information may be requested to fully quote modifications.

### Order Acknowledgments

All orders will be acknowledged promptly, showing how the order was entered, shipping time, and other information pertinent to the order. It is the purchaser's responsibility to verify all the information on the acknowledgment carefully and notify us immediately, in writing, of any discrepancies.

Published ship dates are contingent upon adverse conditions; however, every effort is made to ship as acknowledged.

### Order Cancellations


All cancellations must be made in writing. Administration and/or labor charges may be incurred by the purchaser depending upon the stage of the order. Orders cannot be canceled after the finish process has begun without incurring substantial re-stocking charges.

Once production has begun on product modifications or special finishes the orders cannot be canceled. Items purchased specifically from our vendors for the order, such as textiles or laminates, are subject to our vendor's cancellation terms and re-stocking fees.

### Order Changes

All changes to an order must be in writing and dated. Order changes are subject to our ability to conform. Administration and/or labor charges may be incurred by dealer depending upon the stage of the order. No change can occur once production is started.

### Quickship

Items indicated with a Quickship symbol  ship within 10 business days of receipt of a clean, credit approved purchase order. Product for up to 10 offices or 10 tables can be selected from the Brogan, Finale or Vision series. See individual product pages for those models available on quickship. Available capacity is filled by orders as they are received. If normal 10 day Quickship is not available because capacity has been filled, you will be immediately notified. Changes and cancellations to Quickship orders are not allowed under any circumstances.

### Delivery

Our freight policy consists of prepaid freight to the 48 contiguous states; all other shipments prepaid to port of exit ONLY. JSI reserves the right to select the appropriate carrier and shipment routes. Standard deliveries require docks that can accommodate 75 foot trucks. Pricing in this book is for standard delivery. Standard delivery does not include non-dock delivery, inside delivery, residential delivery, or installation of product. Special requests for delivery should be done at the time of ordering. See below for charges for special delivery.

Orders of less than \$1,000 net will be assessed a handling charge of \$75 net per order.

Any charges arising from failure to meet shipment, re-routing while in transit, or carrier storage charges are the responsibility of the customer.

Contact Customer Service to inquire about skidding of products, special crating of products, blanket wrap services, and product installation. These requests must be made at the time of order.

## Freight Damage

JSI products are packed in cartons and meet or exceed existing codes for furniture and seating products. All shipments are delivered to the carrier in good condition and our liability ceases thereafter. If delivery arrives short or damaged, contact the carrier immediately to file a claim. In the event of concealed damage, notify the carrier and request immediate inspection. Failure to file a claim within 15 days after receipt of merchandise constitutes acceptance and a waiver of any such claims. Please inspect merchandise immediately upon receipt, otherwise there is no recourse. Keep all cartons and packing material, discarding these materials may negate your claim.

Storage of product in areas of uncontrolled humidity and temperature may cause damage to the product and void the JSI warranty.

## Repairs

JSI will not issue credit allowance for any type of repairs without prior written consent.

Sales order, product model numbers, and reason for repair will be expected in order to process the repair request. A digital photo will help to expedite the request. JSI reserves the right to recommend solutions for repair.

## Returns<sup>▲</sup>

No merchandise may be returned to JSI without a signed Return Good Authorization (RGA) form issued by our Customer Service Department. Any authorized return not due to damage or defect will be accessed a 45% restocking fee and all return freight charges must be prepaid. Additional restocking fees may apply for any modification, special or custom built product.

Liability for defective merchandise shall be limited to replacement or repair.

Under no circumstance can we accept COD (Cash On Delivery) returns. Any such shipment will be refused.

## Replacement Parts

Obtain information and pricing on replacement parts by contacting Customer Service. Please have the model number available when requesting replacement parts. Additional information may be required to ensure proper replacement parts.

## Care and Maintenance

### Care of Upholstery Surfaces

Cleanability will vary based on the fabric type. For best results, a professional service is recommended. Dirt and crumbs may be gently brushed or vacuumed off. Spills should be wiped up immediately with a cloth. Vinyl textiles can be cleaned with warm soapy water and then wiped down with a warm damp cloth. For more details on any JSI carded fabric and vinyl, please visit our website at [jsifurniture.com](http://jsifurniture.com) or consult the back of the appropriate swatch card for cleaning codes and any specific instructions. For COM materials, consult with the individual textile manufacturer for cleaning codes and any specific instructions pertaining to your particular fabric.

### Maintenance of Mechanical Parts

Clean any lint or debris from the moving parts of the base mechanisms. Mechanisms have been designed and tested to not require lubrication under normal conditions; however, lubricant can be used if needed.

## Care of Wood Edges and Veneer Surfaces

Clean all surfaces frequently with water dampened soft cloth, moving the cloth with the grain direction. Immediately remove any liquids that come in contact with wood surfaces with a blotting action to absorb liquid. Buff dry. Lift objects to move them, never pull them across the finished surface. For an additional safeguard, use a protective surface pad. This will ensure a lasting finish by protecting your furniture from possible damage caused by pens, cups and sharp objects. Avoid exposure of furniture to extremes of heat and cold, or to wide humidity variances. Avoid exposure of furniture to strong sunlight. Avoid exposure of furniture to harsh solvents such as nail polish remover, acetates, etc., as it will cause finish deterioration. If using a protective glass top, place spacer pads under the glass top to allow the wood to breath.

## Care of Metal Finishes

Wipe smooth powder coat finishes and textured metals with a damp cloth. For stubborn stains and grease marks, use soap and water. Lightly brush textiles metals with a soft, dry brush to remove dirt.

## Fire Retardancy

At a minimum standard, all JSI upholstered products are manufactured to comply with Bureau of Electronics, Appliance Repair, Home Furnishings and Thermal Insulation-Technical Bulletin 117-2013 issued by State of California Department of Consumer Affairs. With a January 1, 2015 effective date, this standard was passed and requires upholstered furniture to be safer from the hazards associated with smolder ignition in all four (4) categories of materials, as applicable.

Compliance with more stringent codes may require special manufacturing considerations and upcharges.

## California Technical Bulletin 133 (CAL 133)

JSI uses a barrier material between the foam cushioning and the upholstery cover in order to comply with CAL 133. The standard upcharge on products specified to comply with CAL 133 is \$58 list per yard of textile.

JSI has performed a series of full scale fire tests on samples - representing a variety of product styles and worst case scenarios of upholstery covers - to comply with the requirements of the state of California Technical Bulletin 133 (CAL 133). Products in compliance will be labeled that they have been manufactured to meet the CAL 133 standard. Only products with internal test data can be labeled.

Some product designs and fabric cannot be combined to comply with CAL 133. Because of this, we reserve the right to reject any request for an upholstery cover, including COM, or product style that we feel may compromise the integrity or safety of a product specified to comply with CAL 133.

Contact Customer Service for a quote if you require laboratory certification that a specific product and upholstery combination WILL PASS CAL 133. The quotation will include testing, video, and transportation charges plus the list cost of the sample.

Our standard lead time will apply to products that do not require certification. Allow an additional six weeks over the standard lead time for products that need actual laboratory certification.

The end user, specifier and/or dealer have the responsibility to make sure all products specified will meet the flammability and safety codes of the jurisdiction where the products will be located and used.

### Textile Carded Programs

JSI is proud to partner with Maharam, Momentum, Ultraleather and Wollsdorf Leather. Please refer to the respective pages in this pricer for each of these partners. Scan the QR codes on the back of the swatch card for latest grades and other information.

### Textile Grade-In Programs

For the convenience of our specifiers, we have graded in the following suppliers:

Arc Com	Pallas Textiles
DesignTex	Stinson
Maharam	Ultrafabrics
Mayer	Wollsdorf Leather
Momentum	

Please contact Customer Service for pricing grades on textiles and leathers not listed.

Indicate on purchase order if JSI is to order the fabric.

Grades and availability of fabric are subject to change without notice. Changes could include but are not limited to price increase, discontinued patterns, discontinued colors, etc. See [jsifurniture.com](http://jsifurniture.com) for up to date information.

Many textiles have repeats and the additional yardage required has been factored in for textiles ordered through the JSI Carded and Grade-In Programs. We reserve the right not to match textiles with a horizontal or vertical repeat greater than 17". Additional charges may apply for textile being applied with special instructions.

Some fabric thickness may cause issue with proper upholstering of tackable wall panels or upholstery privacy screens. Please contact Customer Service, with concerns on the fabric thickness for these items.

### COM Policy

Refer to the COM price column for list prices.

All yardage requirements listed in the price list, are based upon 54" plain non-directional material. The textile on most products is cut "up the roll"; refer to the check list pages for each individual series for further information.

Additional yardage may be required. Contact Customer Service for any of the following conditions to assure proper yardage:

- + horizontal repeats or vertical repeats greater than 3"
- + textile less than 54" wide off the roll
- + patterned textile to be applied a special way

To assure quick turn around and accurate calculation of yardage, please supply the following information:

- + supplier's name
- + pattern name and color name
- + the JSI model numbers and the order quantity
- + any special direction and/or special instructions

We cannot assume responsibility for defective COM delivery to us or for the tailoring quality issues some textiles may create. Bulky textiles, thin weight textiles or fiber content may not tailor well on some models.

### COL Policy

Refer to the COL price column for list prices.

Customer's own leather requirements are based on an average hide of 50 square feet.

Contact Customer Service for requirements on any other sizes.

All square footage requirements are based upon usable footage. The shape of the hide and the usable footage may make it necessary for us to request additional leather.

### Placing Orders with COM or COL

COM & COL orders must include the following:

- + model number where the COM or COL will be applied
- + textile/leather supplier's name
- + sample of the textile/leather attached to order
- + special application instructions

Ship COM/COL prepaid to the following:

### JSI

**Attn: COM Dept**  
**932 Mill Street**  
**Jasper, IN 47546**

**Make sure the supplier tags the shipment with the customer purchase order number and sales order numbers if available.**

All COM/COL orders will ship at standard lead time from the delivery of the COM/COL, except for orders requiring special custom matched finishes or special application of the COM/COL.

# Guide Order Form for COM and COL

**1 Order information:**

**Acknowledgment #:** \_\_\_\_\_ **Purchase Order #:** \_\_\_\_\_

**JSI Representative:** \_\_\_\_\_

**Dealer Name/Project Name:** \_\_\_\_\_

**Contact:** \_\_\_\_\_

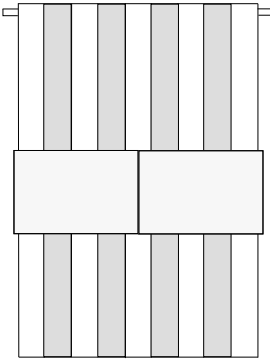
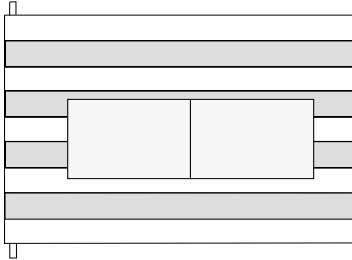
**Address:** \_\_\_\_\_

**Phone:** \_\_\_\_\_ **Email:** \_\_\_\_\_

**Model Number(s) Receiving COM/COL:** \_\_\_\_\_

**2 Select off the bolt application:** *(Check one of the boxes)*

**Up the roll (standard on most seating)**  **Railroaded**

**3 Additional information:**

\_\_\_\_\_

\_\_\_\_\_

**4**

**Attach 4" x 4" sample here.**

photo copy or scan



## Textile and Leather Swatch Card Program

### Maharam - Value Reference 5 Card

Pattern - Bar Grade - C		Pattern - Disc Grade - C		Pattern - Oblique Grade - C		Pattern - Pick Grade - C	
Colorways		Colorways		Colorways		Colorways	
003	005	001	005	001	005	001	006
004	007	002	006	002	006	002	007
		003	007	003	007	003	008
		004		004		004	009
						005	010
Pattern - Coin Grade - C		Pattern - Divide Grade - C				Pattern - Technic Grade - C	
Colorways		Colorways				Colorways	
001	005	005	009			001	004
002	006					002	005
003	007					003	
004							

**NOW!**  
Need it.  
JSI Quickship

*patterns and colors listed above are available for quickship*

### Maharam - Manner / Medium / Messenger / Metric Card

Pattern - Manner (MN) Grade - C		Pattern - Medium (MD) Grade - C		Pattern - Messenger (MG) Grade - C		Pattern - Metric (MT) Grade - C	
Colorways		Colorways		Colorways		Colorways	
013 Ablaze	005 Hush *	003 Alloy *	008 Pecan	077 Ash *	072 Maize *	026 Admiral	002 Fog
022 Aquatic	018 Lioness	006 Bark *	029 Pistachio *	067 Aster *	025 Mao *	020 Alligator *	013 Lava *
026 Basin *	001 Magic *	052 Blackberry	040 Pool *	041 Azure *	048 Neon *	024 Anchor *	007 Mineral
016 Butterscotch	006 Nuance	051 Cascade	016 Port *	001 Balsa *	040 Nile *	009 Arabica	014 Oriole *
019 Caper	020 Parakeet	050 Cosmic	032 Prospect *	008 Bayou *	029 Onyx *	008 Bittersweet	001 Phantom
002 Carob	009 Pathway	036 Delight *	012 Pumpkin *	085 Beyond	079 Oyster	022 Bonsai	018 Pollen *
008 Cocoa *	014 Peel	007 Espresso *	001 Raven *	045 Cactus *	080 Pensive	011 Brick	028 Scuba*
010 Cola	015 Penny *	004 Flax *	045 Sculpture	061 Capri *	060 Peridot*	017 Caramel	027 Seaport*
023 Cottage	003 Porpoise *	047 Hike	002 Smoke *	066 Cassis	024 Poppy *	012 Cardinal *	004 Sourdough
024 Dahlia	027 Schooner *	014 Laser *	048 Tangle	069 Cherry *	084 Robust	015 Cedar	023 Tar
011 Ember	007 Thicket *	022 Marina *	046 Thatched	083 Chili	071 Satsuma *	010 Cerise	005 Toffee
004 Flint	025 Vivid	053 Nasturtium	044 Washed	031 Cloud *	007 Shadow *	006 Driftwood	019 Tupelo
021 Greenway	012 Wagon	039 Nautical *	054 Wooded	038 Depth *	058 Snow *	021 Envy	025 Twilight
017 Harvest		049 Pacific		088 Electric	063 Squall *	003 Fleece	
				087 Everglade	053 Tangelo *		
				059 Fennel	006 Tobacco *		
				082 Fireside	078 Tusk *		
				076 Fossil *	062 Ultramarine *		
				081 Husk	070 Vibrant *		
				050 Hydrangea *	086 Voyage		
				046 Ice *	010 Zinc *		
				054 Lumine *			

**NOW!**  
Need it.  
JSI Quickship

*\*colors marked with an asterisk are available for quickship*

## Textile and Leather Swatch Card Program

### Momentum - Inspired Solutions

<b>Pattern - Camber</b> Grade - G Colorways CAM01 Anatto    CAM03 Zinc CAM02 Deep	<b>Pattern - Cover Cloth</b> Grade - C Colorways CVR01 Antique    CVR08 Platinum CVR02 Cyan        CVR09 Shire CVR03 Delft        CVR10 Sorrel CVR04 Graphite    CVR11 Taupe CVR05 Heirloom    CVR12 Vessel CVR07 Oat            CVR13 Zest	<b>Pattern - Drift</b> Grade - G Colorways DRI01 Beacon        DRI03 Stellar DRI02 Rime	<b>Pattern - Keynote</b> Grade - D Colorways KYN01 Granite        KYN03 Palmetto KYN02 Mesa
<b>Pattern - Centric</b> Grade - F Colorways CEN01 Anatto        CEN02 Sediment	<b>Pattern - Dash</b> Grade - F Colorways DAS01 Batik        DAS02 Zinc	<b>Pattern - Jitney</b> Grade - E Colorways JIT01 Bay            JIT10 Pool JIT03 Dune            JIT11 Reed JIT04 Forest          JIT12 Salt JIT06 Lake            JIT13 Slate JIT07 Oar             JIT14 Teak JIT08 Pear            JIT15 Tulip	<b>Pattern - Torque</b> Grade - H Colorways TRQ01 Quarry        TRQ02 Tropicalia
			<b>Pattern - Wander</b> Grade - F Colorways WAN01 Limelight     WAN03 Sterling WAN02 Orangery

*Need it.*  
*JSI Quickship*  
*patterns and colors listed above are available for quickship*

### Momentum - Color Card

<b>Pattern - Infinity</b> Grade - B Colorways INF01 Aluminum    INF17 Maize INF02 Aster        INF18 Papaya INF03 Atoll        INF19 Pewter INF04 Barley        INF22 Rinse INF05 Berry        INF24 Sable INF07 Capri        INF25 Stucco INF08 Dove        INF26 Terrain INF10 Graphite    INF30 Vine INF11 Gull	<b>Pattern - Marathon</b> Grade - B Colorways MRN01 Alert        MRN16 Noir MRN03 Caravel    MRN18 Oz MRN06 Clove        MRN19 Pinot MRN07 Curry        MRN20 Pollen MRN08 Cyan        MRN21 Rain MRN09 Deep        MRN23 Sprite MRN10 Flax        MRN24 Storm MRN12 Foliage     MRN27 Toile MRN13 Herb        MRN29 Vivacious MRN15 Marigold	<b>Pattern - Odyssey</b> Grade - B Colorways ODY02 Amp        ODY17 Linen ODY03 Breeze     ODY19 Maritime ODY06 Cedar        ODY23 Primary ODY07 Craft        ODY24 Roast ODY08 Cruise        ODY25 Rue ODY10 Eggplant    ODY26 Sangria ODY11 Emerald     ODY27 Skim ODY12 Fossil        ODY28 Smith ODY13 Ink            ODY29 Tinge ODY15 Iris            ODY30 Western	<b>Pattern - Tradition</b> Grade - B Colorways TRD01 Ash        TRD14 Malbec TRD02 Branch    TRD16 Mist TRD03 Class      TRD18 Plated TRD04 Distant    TRD19 Regal TRD05 Flirt        TRD21 Soar TRD06 Frond        TRD22 Soy TRD08 Hedge        TRD24 Sprout TRD09 Hidden        TRD26 Sun TRD12 Kelly        TRD27 Tango TRD13 Latte        TRD29 Wash
	<b>Pattern - Millennium</b> Grade - B Colorways MLL02 Amber        MLL20 Plateau MLL04 Cascade      MLL21 Pool MLL06 Cerise        MLL22 Pyrite MLL07 Clean        MLL23 Safari MLL08 Coastal        MLL24 Sapphire MLL10 Crisp        MLL25 Spark MLL11 Electric      MLL26 Steel MLL17 Onyx        MLL27 Tanzanite MLL18 Orchid        MLL28 Thrill MLL19 Peridot        MLL30 Zinc		

*Need it.*  
*JSI Quickship*  
*patterns and colors listed above are available for quickship*

## Textile and Leather Swatch Card Program

### Momentum - Everyday Card

<b>Pattern - Amuse</b> Grade - D		<b>Pattern - Fuse</b> Grade - A		<b>Pattern - Knack</b> Grade - C		<b>Pattern - Syntax</b> Grade - C	
Colorways		Colorways		Colorways		Colorways	
AMU01 Admiral	AMU03 Mocha	FUS11 Azurean	FUS06 Morel	KNA05 Brisk	KNA01 Reed	SNY01 Mahogany	SNY05 Turquoise
AMU02 Alloy	AMU04 Quartz	FUS01 Carmine	FUS07 Pepper	KNA06 Carbon	KNA03 Zest	SNY02 Nectar	SNY06 Violet
<b>Pattern - Bangle</b> Grade - A`		FUS02 Cress	FUS08 Pimento	KNA08 Filament	KNA13 Zing	SNY03 Plant	SNY07 Pewter
Colorways		FUS03 Ginger	FUS13 Pristine	KNA09 Fresco		SNY04 Shale	
BAN01 Baltic	BAN05 Sable	FUS12 Iris	FUS09 Saffron	<b>Pattern - Lineup</b> Grade - C		<b>Pattern - Vox</b> Grade - B	
BAN02 Cork	BAN06 Suede	FUS04 Lunar	FUS10 Walnut	Colorways		Colorways	
BAN03 Granite	BAN07 Teak	FUS05 Malted		LUP01 Baltic	LUP05 Shadow	VOX13 Bark	VOX15 Morel
BAN04 Orchid		<b>Pattern - Habit</b> Grade - C		LUP02 Fern	LUP06 Spice	VOX01 Black	VOX09 Mystic
<b>Pattern - Decode</b> Grade - C		Colorways		LUP03 Pewter	LUP07 Tranquil	VOX02 Cocoa	VOX10 Navy
Colorways		HAB01 Aspen	HAB03 Kindle	LUP04 Sandstone		VOX03 Downpour	VOX16 Oat
DEC01 Alloy	DEC03 Elm	HAB02 Dune	HAB04 Pier	<b>Pattern - Origin</b> Grade - A		VOX05 Forthe	VOX17 Snap
DEC02 Blaze	DEC04 Grove	<b>Pattern - Insight</b> Grade - A		Colorways		VOX08 Hot	VOX18 Turquoise
<b>Pattern - Free</b> Grade - C		Colorways		ORG01 Amethyst	ORG08 Jet	VOX14 Limelight	
Colorways		INS11 Bark	INS10 Real Red	ORG17 Basalt	ORG23 Malt		
FRE01 Cocoa	FRE06 Pearl	INS07 Ebony	INS03 Summit	ORG18 Caraway	ORG24 Manta		
FRE02 Evening	FRE07 Platinum	INS08 Fossil	INS12 Wasabi	ORG19 Eureka	ORG25 Mikan		
		INS09 Periwinkle		ORG20 Euro	ORG26 Poppy		
				ORG22 Gaia	ORG10 Sapphire		
				ORG07 Iron			

**NOW!**  
Need it.  
JSI Quickship

patterns and colors listed above are available for quickship

### Momentum - Composite Solutions Card

<b>Pattern - Beeline</b> Grade - C		<b>Pattern - Canter</b> Grade - C		<b>Pattern - Cashmere II</b> Grade - C		<b>Pattern - Kindred</b> Grade - F	
Colorways		Colorways		Colorways		Colorways	
BEL01 Canvas	BEL12 Sisal	CNR01 Alfalfa	CNR24 Pyrite	CA132 Acorn	CA139 Olive	KND01 Chai	KND05 Mist
BEL06 Fossil	BEL13 Sprout	CNR15 Baltic	CNR09 Sable	CA128 Bone	CA136 Seashore	KND02 Flint	KND06 Orangery
BEL07 Geyser	BEL16 Walnut	CNR04 Chestnut	CNR10 Saddle	CA134 Chestnut	CA131 Smoke	KND03 Grain	KND07 Union
BEL11 Portobello		CNR06 Mica	CNR11 Safari	CA127 Ebony	CA130 Taupe	KND04 Macaw	
<b>Pattern - Bravo II</b> Grade - D		CNR07 Night	CNR12 Sand	CA143 Fennel	CA135 Wine	<b>Pattern - Silica</b> Grade - F	
Colorways		CNR23 Nimbus	CNR13 Willow	CA138 Nile	CA120 Yacht	Colorways	
BRV21 Bark	BRV15 Night	CNR08 Onyx		CA122 Ocean		SIL01 Alloy	SIL20 Haze
BRV19 Black	BRV04 Ranch	<b>Pattern - EON</b> Grade - C		Colorways		SIL02 Appletini	SIL37 Jewel
BRV20 Cinder	BRV07 Saddle	Colorways		EON01 Freshwater	EON05 Nocturnal	SIL04 Bistro	SIL23 Manor
BRV23 Clay	BRV16 Sunset	EON02 Goldmine	EON06 Omega	EON02 Goldmine	EON06 Omega	SIL07 Brownstone	SIL24 Marigold
BRV12 Dusk	BRV01 Tumbleweed	EON03 Humid	EON07 Path	EON03 Humid	EON07 Path	SIL08 Burnished	SIL38 Nero
BRV02 Hematite	BRV09 Twilight	EON04 Mystery		EON04 Mystery		SIL11 Coppercrest	SIL39 Petunia
BRV17 Iron						SIL12 Cumulus	SIL40 Quartz
						SIL15 Gallant	SIL41 Sands
						SIL17 Ginger	SIL33 Skyward

composition solutions card patterns continued on the next page

## Textile and Leather Swatch Card Program

### Momentum - Composite Solutions Card *(Continued)*

Pattern - Silica Leather Grade - F		Pattern - Silica Tech Grade - F		Pattern - Sublime II Grade - C		Pattern - Velocity Grade - D	
Colorways		Colorways		Colorways		Colorways	
SLL01 Almond	SLL09 Hyacinth	SLT01 Calm	SLT15 Tangelo	SUB05 Agate	SUB06 Oxide	VEL01 Aloe	VEL05 Sandstone
SLL02 Aloe	SLL10 Ink	SLT02 Fog	SLT16 Tanzanite	SUB09 Beryl	SUB15 Patina	VEL02 Azure	VEL06 Snow
SLL03 Barley	SLL11 Juniper	SLT05 Macadamia	SLT10 Urbanite	SUB03 Bronze	SUB07 Peridot	VEL03 Charcoal	VEL07 Sycamore
SLL04 Chambray	SLL12 Lichen	SLT06 Mineralize	SLT11 Verdigris	SUB14 Gold		VEL04 Pond	
SLL05 Driftwood	SLL13 Madder	SLT14 Nightfall	SLT12 Vintage				
SLL06 Dune	SLL14 Pewter	SLT07 Paloma	SLT13 Willow				
SLL07 Earthen	SLL15 Raisin	SLT08 Sablewood					
SLL08 Eclipse	SLL16 Saddle	SLT09 Sandstone					

*composite solution patterns and colors listed are available for quickship*

### Ultraleather

Pattern - Brisa Grade - E		Pattern - Pony Grade - E		Pattern - Ultraleather Grade - E		Pattern - Viva Grade - E	
Colorways		Colorways		Colorways		Colorways	
BRI36 Apple Green	BRI12 Night Navy *	PNY01 Bay	PNY05 Galacian	ULL16 Adobe	ULL20 Raven Wing	VIV01 Aluminum	VIV08 Lantern
BRI34 Ash	BRI38 Pomp. Red	PNY02 Black Forest	PNY06 Marengo	ULL10 Arctic	ULL46 Stone *	VIV02 Baha	VIV09 Lava
BRI14 Aztec	BRI19 Salsa	PNY03 Danube	PNY07 Mustang	ULL48 Baltic	ULL49 Toro	VIV03 Balsa	VIV10 Maize
BRI37 Bark	BRI39 Shiitake	PNY04 Dapple	PNY08 Shire	ULL07 Buff	ULL09 Walnut *	VIV04 Cinder	VIV11 Nublan
BRI31 Birch	BRI32 Sterling Blue			ULL47 Charcoal	ULL50 Whiskey	VIV05 Driftwood	VIV12 Poinsettia
BRI21 Black Onyx *	BRI17 Truffle	<b>Pattern - Uccello</b>		ULL42 Fudge	ULL45 White	VIV06 Elm	VIV13 Sugar
BRI20 Cabernet	BRI24 White *	Grade - E		ULL11 Papyrus*		VIV07 Imperial	
BRI10 Desert Clay		Colorways					
		UCC01 Beech	UCC06 Oyster				
		UCC02 Beeswax	UCC07 Possum				
		UCC03 Fox	UCC08 Seal				
		UCC04 Husk	UCC09 Sequoia				
		UCC05 Mink	UCC10 Thicket				
<b>Pattern - Brisa Distressed</b>							
Grade - E							
Colorways							
BDS05 Bridle	BDS09 Saddle						
BDS03 Buckskin	BDS07 Steerhide						
BDS08 Iron	BDS04 Waylan						
BDS06 Lasso							

*\*colors marked with an asterisk are available for quickship*

### Wollsdorf Leather Card

Pattern - FOC Earth Grade - L2				Pattern - Euroglazed Grade - L2	
Colorways				Colorways	
FOC105 Antra	FOC032 Chocolate	FOC046 Lagoon	FOC049 Spirit	EUR003 Antique Blue	EUR010 Forest
FOC026 Avocado	FOC025 Clover	FOC034 Magnolia	FOC007 Tobacco	EUR100 Black	EUR011 Mahogany
FOC001 Black	FOC035 Fawn	FOC125 Olive	FOC048 Teak	EUR009 Blackberry	EUR007 Patina Red
FOC030 Bone	FOC121 Garnet	FOC044 Orange	FOC102 Weiss	EUR008 Chestnut	EUR002 Snuff
FOC028 Camel	FOC104 Grey	FOC029 Parchment	FOC101 White		
FOC120 Campari	FOC103 Haze	FOC041 Persimmon	FOC126 Zeder		
FOC039 Caramel	FOC042 Honeydew	FOC047 Russet			
FOC146 Caribbean	FOC038 Indigo	FOC043 Saddle			
FOC037 Chateau	FOC012 Ivory	FOC031 Safari			

## Arc Com Fabric Grading

For memo samples call Arc-Com at 800-223-5466

Grades and availability of fabric are subject to change without notice. Changes could include but are not limited to price increases, discontinued patterns, discontinued colors, etc. See [jsifurniture.com](http://jsifurniture.com) for updated information.

Pattern	Grade	Pattern	Grade	Pattern	Grade	Pattern	Grade
Allegra	E	Fiore	G	Metro	I	Spectrum	D
Alpha	E	Fireflies	E	Mirror, Mirror	E	Spin	G
Analog	H	Forsythia	G	Monte Carlo	F	Spirit	D
Antigua	E	Francesca Wool	F	Moon Beam	E	Spot-On	F
Apex	G	Francesca Wool II	H	Moon Beam 2	E	Spotlight	G
Arashi	F	Frontier	C	Morocco	F	Spring	G
Astral	F	Galaxy	E	Murano	G	Spyro	F
Atomic	H	Gamma	E	Mystique	E	Stonehenge	G
Aurora	F	Gardenia	F	Navigator	F	Strand-It	G
Axis	F	Gatsby	D	Network	G	Strata	D
Bauble	F	Gem	D	Niagara	F	Streamline	D
Beat Box	G	Geostitch	F	Nova	G	Symphony	G
Block Party	G	Glimmer	E	Oasis	F	Tally	E
Bloom	G	Grand Central	E	Odyssey	E	Tango	F
Blossom	G	Grid	F	Ombre Petal	F	Tectonic	F
Boardwalk	E	Harlequin	G	Omega	E	Tempo	F
Bounce	G	Highlands	F	Orion	D	Terrain	D
Bourbon Street	F	Hopscotch	G	Pala	F	The Plaid	I
Brayer Flower	F	Hush	E	Palatine	E	Theory	C
Bronco	E	Iguana	E	Palatine 2	E	Trio	F
Bubbly	G	Illusion	C	Panache	E	Tritik	F
Campus Stripe	F	Illusion 2	C	Pebble Beach	D	Uptown	H
Candy Land	G	Intaglio	E	Pinball	E	Urban	G
Carnival	E	Intaglio 2	E	Pinpoint	E	Velocity	F
Casablanca	G	Intersect	E	Plateau	D	Vineyard	F
Cascade	F	Isabella	D	Polo	F	Vista	D
Cassio	E	Itajime	F	Posh	F	Volley	F
Channel	E	Jardin	H	Prism	C	Volt	J
Chit-Chat	E	Jing	E	Quad	F	Wonderland	G
Chroma	E	Jive	F	Radiant	G	Yoyo	H
Cirque	G	Juliet	I	Radius	G	Zipline	F
Clarion	F	Katano	E	Ravenna	F		
Coastline	E	Key	F	Rhythm	F		
Column	E	Kinetic	F	Ringling	F		
Compass	I	Kirigami	F	Riviera	G		
Constantine	H	Kumo	F	Robotic	F		
Contour	D	Laurel	G	Rodeo	D		
Crossroads	E	Leaflet	F	Roundabout	E		
Dakota	D	Legacy	E	Royal Garden	H		
Dakota 2	D	Leonardo	G	Sagrada	J		
Dazzle	G	Loara	F	Sahara	E		
Delphi	D	Lotus	F	Samba	F		
Delta	D	Luxe	E	Santa Fe	E		
Durango	C	Lyre	E	Savannah	F		
Dynasty	E	Lyric	G	Saxon	G		
Echo	G	Marathon	E	Sequoia	E		
Eclipse	F	Mason	F	Sherlock	D		
Empress	D	Masquerade	G	Shibori	G		
Etc.	F	Meadow	G	Shimmer	D		
Etch	E	Meridian	C	Shimmer 2	D		
Facet	J	Mesa	D	Silverado	D		

## Designtex Fabric Grading

For memo samples call Designtex at 800-221-1540

Grades and availability of fabric are subject to change without notice. Changes could include but are not limited to price increases, discontinued patterns, discontinued colors, etc. See [jsifurniture.com](http://jsifurniture.com) for updated information.

Pattern	Grade	Pattern	Grade	Pattern	Grade	Pattern	Grade	Pattern	Grade	Pattern	Grade
Acacia	G	Circolo	F	Henrik Small W/Knit	J	Metamorphosis	H	Rotary	I	Tweed Multi	D
Adler	E	Circumference	I	Backing	J	Metta	D	Rothestay	G	Urban Grid	G
Aggregate	F	Claire	I	Hexstripe	F	Microgrid	E	Rothestay with	H	Valanka	I
Ainsley	I	Closed Loop	F	Holmes	G	Migration	H	Backing	H	Valet	E
Aksel	F	Cobble	J	Honor Plus	I	Mingle	F	Rough & Ready II	F	Variant	I
Alcazar	E	Colorblock	G	Horizon	H	Mod	H	Round Leaves	I	Versed	D
Alchemy	E	Colorful Plaid	E	Hyphen	F	Modern Tweed	I	Rove	H	Vivid	D
Aleman	H	Concept	H	Inertia	H	Moderne	H	Rumeli	E	Volley	H
Alistair	G	Converge	G	Inga Small	I	Mohair Plus	J	Samba	H	Vox	F
Alpine	D	Cross Court	H	Inga Small W/Knit	J	Motif	F	Samba Otra Vez	H	W	F
Amaranth	H	Crosshatch	G	Backing	J	New Selkrik	H	Saugatuck	F	Westside	I
Amuse	I	Crossweave	D	Inkling	F	Nexus	H	See Saw	H	Whim	F
Annex	F	Crosswind	F	Inlet	F	Noble	D	Seed	G	Windowpane	E
Appleseed	F	Culebra	I	Inside Edge	F	Nonchalant	E	Sett	I	Winsome	E
Argiano	E	Current	F	Interlock	G	Notion	G	Shibori Stripe	G	Wire	J
Array	I	Cusco	I	Introvert	E	Omar	E	Shimmering Tide	H	Woodcut	F
Arthur	I	Cut & Paste	I	Irregular Grid	E	Ophidian	F	Signal	I	Wren	D
Aster	I	Dahlia	H	Isometry	H	Opulent	D	Singing In The Rain	D	Yoruba	G
Astrid	E	Dart	G	Isotope	F	Oscillate	G	Skye	H	Yucca	F
Banda	G	Dashing	D	Jaunt	I	Oxford Stripe	H	Sorano	D	Zhuba	F
Baratto	G	Delaine	F	Journey	I	Palomino	E	Spandau	E	Zocalo	H
Barque	J	Dharma Stripe	E	Kabuki	F	Parga	E	Spiro	G		
Battista	I	Dichotomy	H	Kalahari	E	Pennington	I	Splendor	D		
Bee	D	Dot To Dot	G	Klange	F	Phase	F	Stacks	H		
Beetled Linen	H	Draft	F	Komposition	F	Pigment	G	Starburst	G		
Beguiled By The Wild	G	Eastside	I	Lambert	G	Piiki	H	Steppe	E		
		Ellipsis	C	Lattice	H	Pika	E	Striae	E		
Big Dot	F	Eon	F	Leaf Dot	F	Pinball	I	Sugar Shoots	H		
Billiard Cloth	F	Epiphany	F	Leafette	E	Pivot	E	Swayed	J		
Billiard Panel	E	Essence	C	Leap	F	Pleat	F	Swing	J		
Birch Bark Plaid	H	Faux Sure	F	Leaves	G	Pop Art	H	Swing Set	G		
Bit	E	Florin	F	Leland	F	Porte	F	Synthesis	I		
Block Print	H	Flux	G	Linari	D	Posey	H	Tack Cloth	F		
Bolt	F	Fortuna	H	Lindos	F	Prairie	E	Tarascon	D		
Bordo	H	Friendly Faux	F	Lioret	F	Precision	F	Terrain	G		
Botanique	E	Fuse	G	Little Dot	F	Prime	D	Tesellate	I		
Boucle	F	Gale	E	Little Plaid	E	Quintessence	G	Tetris	J		
Boucle Two-Tone	E	Gallone	F	Lofty	D	Radar	F	The Last Aphid	I		
Bounce	H	Gamut	C	Lolland	I	Rail	H	Tinos	G		
Breena	E	Glaze	F	Loop To Loop	H	Razor Stripe	H	Tiny Herringbone	F		
Bunta	F	Gleam	F	Lorien	G	Refine	D	Titanium	H		
Caiman	E	Gradate	G	Ludington	C	Restore	F	To The Point	E		
Cascadia	E	Gramercy	J	Luster	F	Reuse	G	Tombolo	E		
Catalyst	F	Grandeur	D	Lydia	I	Rice	F	Top Spin	I		
Cestino	G	Griglia	F	Maglia	H	Rio Grande	F	Trace	J		
Chapiteau	E	Hashtag	E	Mandala	F	Rivergrass	F	Tramway	G		
Checker Stripe	I	Heather	G	Margin	I	Rivet	E	Transport	H		
Chevron	J	Hem Stitch	E	Match Point	I	Rivet Pearl	E	Travertine	E		
Chromatic	E	Henrietta	I	Melange	E	Rocket	D	Tumble Stones	H		
Circa	F	Henrik Small	I	Melrose	I	Rosairo	I	Tumbleweed	F		

# Maharam Fabric Grading

For memo samples call Maharam at 800-645-3943

Grades and availability of fabric are subject to change without notice. Changes could include but are not limited to price increases, discontinued patterns, discontinued colors, etc. See [jsifurniture.com](http://jsifurniture.com) for updated information.

Pattern	Grade	Pattern	Grade	Pattern	Grade	Pattern	Grade	Pattern	Grade
Abacus	J	Coincide High	G	Hero by Kvadrat	F	Pick	C	Strum	F
Abacus Standard	G	Performance	G	Houndstooth	I	Pick Crypton	F	Sudden	F
Acre	F	Colline by Kvadrat	F	Hum	E	Pitch	E	Surge	F
Across*	G	Colorwheel	I	Inlay 466353	I	Plait	F	Tailor	F
Akimbo	F	Column	H	by Hella Jongerius	I	Plait High Performance	G	Tally	G
Align	F	Commentary	F	Insignia	H	Plural	J	Tandem	G
Alloy	E	Compound	F	Instill	E	Ply Mesh Black/Tan	J	Teatro	H
Alpaca Herringbone	J	Confetti	J	Jacobs Coat	J	Pocket	G	Technic	C
Alter	F	Cotton Velvet	J	Kindred	H	Point	J	Tend	F
Anagram	I	Couple	H	Knot	I	Quatrefoil	J	Terrace	F
Arabesque	I	Cover	F	Lariat	E	Quick	E	Ticker	G
Aria	I	Crew	H	Latch	J	Radiant	J	Tilt	G
Array	G	Crosspatch	J	Ledger	E	Recollection	F	Tokyo by Kvadrat	H
Article	D	Crush	F	Lens	G	Reel	H	Tonica by Kvadrat	F
Balustrade	I	Cursive	J	Lift	G	Regatta	J	Tonus by Kvadratt	G
Banister	H	Cycle	F	Lineage	F	Remix by Kvadrat	F	Tonus Meadow	G
Bar	C	Dapper	E	Link	G	Repeat Dot Ring	J	by Kvadrat	G
Bar Crypton	F	Dart	G	Manner	C	Ring	G	Toostripe	J
Basel by Kvadrat	F	Dash	F	Marquee	E	Rise	I	Trait	F
Before	F	Decode	G	Matrix by Kvadrat	H	Rove	F	Transport	I
Beside	F	Defer	E	Meander	G	Rubric	F	Tread	G
Bevel	E	Design 9297	J	Mechanism	H	Rule	G	Treat	G
Bitmap	J	Disc	C	Medium	C	Runner	G	Trellis	I
Blip	H	Disc Crypton	F	Melange Tweed	I	Runner Standard	E	Tremor	F
Blumen	J	Disperse	H	Meridian	F	Salon	H	Trio	J
Bound	E	Ditto	G	Messenger	C	Scape	G	Turn	H
Boundary	F	Divide	C	Metric	C	Schema	F	Twice	F
Bridge	E	Divide Crypton	F	Micro	E	Scout	F	Twine	F
Bright Angle	H	Divina by Kvadrat	G	Mikado	J	Scribe	F	Unisol	J
Bright Cube	H	Divina MD by Kvadrat	G	Milestone	C	Scuba	E	Urban	H
Bright Grid	H	Divina Melange by	G	Mimic	G	Seam	F	Vary	E
Brim	G	Kvadrat	G	Mineral	F	Semblance	C	Vases by Hella	I
Candid	E	Division	E	Minicheck	I	Sequence	F	Jongerius	I
Canvas by Kvadrat	F	Double Triangles	I	by Alexander Girad	I	Shadowbox	G	Velvet Stripe	J
Cartouche	F	Ellipsis	F	Minimal	F	Sheen	F	Venn	G
Centric	I	Emblem	G	Mister	H	Shuttle	G	Vestige	H
Certain	F	Emboss	F	Mode	D	Shuttle Standard	E	Vineyard	I
Chalet	F	Emmesh	F	Mohair Supreme	J	Signal	F	Voyage	I
Chance	G	Exchange	E	Molly by Kvadrat	F	Silk Canvas	I	Waterborn by Kvadrat	I
Checker by Alexander	I	Facets	I	Monk's Wool	J	Skein	E	Waxen	D
Girard	I	Fasten	H	Mortise	G	Slant	F	Wedge	J
Checker Split	J	Fathom	F	Oblique	C	Small Dot Pattern	J	Weimar	H
Chenille Cord	G	Feature	F	Octave	J	Snap	J	Whirl	F
Chenille Stripe	I	Fiddle	H	Offset	G	Soft Tweed	I	Wool Rib	I
Chime	E	Floret	G	Omen	F	Sort	I	Wrap	J
Chock	G	Fluent Crypton	F	Optik	J	Stack	E		
Cinch	D	Fluted Silk	I	Orakelblume	J	Star by Kvadrat	H		
Cipher	H	Focus	E	Ottoman Stripe	J	Stature	F		
Circles	J	Fraction	G	Outback by Kvadrat	G	Steady	E		
Circuit	G	Fruit by Hella Jongerius	J	Parched Silk	I	Steady Crypton	F		
Coach Cloth	I	Garden	I	Park	J	Steelcut by Kvadrat	G		
Cobblestone	J	Glint	E	Pavement	I	Steelcut Trio	G		
Coda by Kvadrat	I	Grade	H	Paver	F	by Kvadrat	G		
Coin	C	Hallingdal by Kvadrat	G	Pebble Wool	J	Strand	G		
Coin Crypton	F	Hedge	F	Pebble Wool Multi	J	Stride	G		
Coincide	E	Helix	H	Pennant	H	Stripes	J		

## Mayer Fabric Grading

For memo samples call Mayer at 800-428-4415.

Grades and availability of fabric are subject to change without notice. Changes could include but are not limited to price increases, discontinued patterns, discontinued colors, etc. See [jsifurniture.com](http://jsifurniture.com) for updated information.

Pattern	Grade	Pattern	Grade	Pattern	Grade	Pattern	Grade	Pattern	Grade
Acclaim	D	Daydream	D	Holiday	E	Obi	F	Silk Screen	C
Align	C	Dazzle	D	Hombre	E	Obsession	G	Silverweave	D
All Seasons FR	C	Debonair	G	Hoopla	D	On The Spot	G	Skate	D
All Use FR	C	Debut	F	Hopsack	E	Optic	C	Sketch	C
Amadeus	G	Destiny	D	Illusion	G	Orbit	D	Slick	D
Antique	D	Destiny plus	E	Images	D	Origami	F	Smart Suede	D
Apex	C	Durablock™	E	Impulse	D	Ottoman	F	Social Network	E
Arabesque	E	Detail	E	In The Groove	D	Outback	C	Solaris	F
Aristocrat	D	Disco	E	Infinity	G	Oxen SP Black	A	Soleil	F
Array	F	Dublin Tweed FR	D	Interlace	D	Palermo	D	Solid Ground	E
Artistry	C	Durango	C	Interlochen	D	Panache	G	Sophisticate	C
Ascension	G	Duraweave® 10	B	Intrigue	D	Paparazzi	F	Source	D
Athens FR	D	Echo	D	Jekyll & Hyde	C	Pastime	E	Source plus	E
Atomic	C	Ecosphere	F	Jenga	E	Patent	E	Durablock™	E
Aurora	G	Eleanor Rigby	F	Jitterbug	E	Patio	C	Spacer Mesh	B
Avenue	F	Element	C	Journey	E	Pavilion	F	Spirograph	D
Awakening	H	Empire	I	Jubilee	D	Peerless	C	Spotlight	F
Banner	C	Emu	C	Juncture	H	Phoenix	C	Stanza	E
Bar None	E	Encore	F	Karma	F	Pinehurst	D	Stop & Go	F
Batik	C	Enigma	G	Katagami	J	Pinnacle	D	Stratosphere	H
BeBop	F	Entourage	F	Key Largo	C	Plaza	D	Suede	D
Bella	F	Entwine	D	Kismet	F	Portal	E	Swank	F
Berkshire	D	Equation	D	Kobe	C	Positive Thoughts	G	Synapse	F
Big Top	F	Equinox	D	Komodo	D	Prado	D	Tangled Web	G
Blocks	C	Erode	G	Laredo	E	Primo	D	Theory	C
Bolero	D	Escapade	G	Linen	C	Prism	C	Time Line	E
Botanica	F	Esprit	D	Links	D	Pulse	F	Toss Up	D
Boteh	J	Essex	D	Locomotion	D	Punch	C	Tributary	D
Brio	E	Europa	E	Longhorn	D	Quark	F	Turnabout	G
Bungalow	I	Evolve	G	Lunar	E	Quattro	B	Tussah	D
Burst	E	Facets	F	Madras	E	Rain Dance	E	Twister	E
Camelot	E	Factor	D	Madrid SP Black	A	Ranchero	A	Uptown	C
Canvas	E	Fairy Tales	G	Makore	F	Rapport	C	Valet	C
Caressa FR	C	Fanfare	F	Malibu	D	Ratio	F	Variant	C
Caressa Suede	C	Fantasy	F	Mandala	H	Razzmatazz	F	Venetian	H
Cascade	D	Fathom	E	Marquise	C	Realm	F	Venue	D
Catalyst	D	Figure Eight	C	Marvel	F	Rebound	F	Verona	C
Cavalier	C	Finale	D	Matrix	G	Reiki	F	Vibrant	D
Cayman	F	Finesse	C	Maverick	C	Relic	F	Viewpoint	F
Celtic	E	Finish Line	E	Maze	F	Replay	F	Vintage Mohair	I
Chaps FR	C	Flock	G	Meander	D	Reveal	D	Vinyl Stat ESD	D
Charade	G	Florentino	C	Melody	E	Reverb	C	Vogue	E
Charette	E	Flower Power	D	Metro	D	Rhythm	G	Volante	H
Circuit	H	Focal Point	C	Microdot	C	Rift	D	Wallaby SP Black	A
Circumference	G	Forte	A	Milano	D	Rock & Roll	F	Webscape	D
Collage	G	Foundation 10	B	Monogram	D	Round 'N Round	F	Whimsy	G
Component	D	Gala	F	Moonscape	C	Sakura	G	Wildflower	G
Contempo	C	Geisha	G	Mosaic	D	Samurai	F	Willow	E
Continuum	C	Genesis	C	Mosaic plus	F	Sashiko	G	Wool Boucle	G
Cork	E	Genesis plus	D	Durablock™	F	Sequel	B	Xanadu	G
Counterpoint	D	Durablock™	D	Motif	G	Sequel plus	D		
Cross Check	B	Glee	D	Myriad	F	Durablock™	D		
Crystals	D	Glimmer	E	Mystic	C	Sequence	C		
Cuddle Up	F	Groundworks	F	New Dimensions	G	Shantung	D		
Curlicue	C	Guardian	C	Nirvana	G	Sherlock	C		
Dakota	C	Haberdash	C	Nostalgia	D	Shibori	F		
Dande	E	Habitat	E	Nuance	E	Shimmer	E		
Dapper	C	Hole In One	F	Nylon-Stat ESD	E	Sierra SP Black	A		



# Momentum Fabric Grading

For memo samples call Momentum at 800-366-6839

Grades and availability of fabric are subject to change without notice. Changes could include but are not limited to price increases, discontinued patterns, discontinued colors, etc. See [jsifurniture.com](http://jsifurniture.com) for updated information.

Pattern	Grade	Pattern	Grade	Pattern	Grade	Pattern	Grade	Pattern	Grade
Ace	C	Cycle	D	Impact	D	Ohs II	G	Silica Leather	F
Acoustic	F	Dash	F	Imperial Mohair	J	Ona	I	Silica Reach	G
Agora II	D	Dayspell	H	Index	G	Origin	A	Silica Roam	G
Aldo	G	Decode	C	Infinity	B	Ozone	H	Silica Stride	G
Align	I	Delano	G	Infusion	F	Pace Crypton	E	Silica Tech	F
Allegory	I	Delve	I	Inner Circle	H	Pace Incase	D	Silica Waltz	G
Amenity II	G	Dive	F	Insight	A	Panorama	J	Silk Struktur	H
Amuse	D	Dividend	G	Interim	I	Parable	F	Sketching Air	G
April	F	Dogwood Leaves	E	Intermezzo	I	Parkside Crypton	F	Skip	C
Ardour II	H	Domain	F	Intermix II	D	Parkside Incase	E	Small Talk	G
Arrange	H	Drift	G	Intersect	C	Parterre	E	Solace	C
Ascend	E	Duo	F	Interval	B	Passages	I	Solo 2	D
Audio	G	Ebb	F	Isla	E	Perk	B	Soma	G
Audubon	H	Edison	H	Jardin	G	Photon	H	Sort	F
Avanti	H	Effloresce	H	Jest	F	Pierre	G	Span Crypton	E
Avenue	D	Elevate	I	Jitney	E	Ping	D	Span Incase	D
Axis	C	Elle	F	Juncture	H	Pique	D	Spin	G
Bandwidth II	F	Emanate	H	Keynote	D	Plus	F	Splendeur	J
Bangle	A	Embark	F	Kindle	F	Propensity	C	Starboard	F
Banter	H	Eon	C	Kindred	F	Prospect	D	Streamers	D
Basis	B	Essay	F	Kinney	D	Proviso	G	Strut	E
Beeline	C	Estrella	H	Knack	C	Proximity	G	Sublime II	C
Beep	E	Evolve	H	Kudos	G	Quirk	D	Substance	J
Bento	F	Expo	B	Lana	I	Raffia	I	Sway II	G
Bias	G	Feliz	G	Ledge	E	Rally	H	Symbol	I
Bloc	G	Felt	G	Lella	G	Rattan	I	Synergy	D
Boom II	D	Felt Melange	G	Lina	I	Recollection II	G	Syntax	C
Boxcar	G	Flection	G	Lineage	I	Redux	D	System	G
Bravo II	D	Fleet	E	Lineup	C	Rein II	D	Tactic	G
Brisk	G	Flow	G	Linq	I	Respite	C	Tesla	G
Buoy	G	Flux	G	Livia	J	Revolve	H	Tetra	D
Cairns	H	Focal	D	Lloyd	G	Riga	G	Tone	E
Cairo II	G	Foray	D	Lore	F	Rivet	D	Torque	H
Camber	F	Free	C	Loupe	I	Row	D	Tradition	B
Canter	C	Fringe	E	Lucio	H	Sail	H	Trefoil	I
Carlo	H	Fuse	A	Ludwig	G	Scan	I	Trove	H
Cashmere II	C	Gentry	H	Malmo	G	Scape	G	Turin	G
Catalogue	H	Geo	J	Mapping Ideas	G	Scrabble	C	Twist	G
Central	E	Golden Leaf Tree	E	Marathon	B	Scribe	D	Upside	G
Centric	F	Gradient 18	H	Marcel	H	Sense	E	Vario	D
Channel	E	Gradient 36	J	Medley	F	Sidebar Crypton	F	Veer	H
Chant	F	Gradient Solid	F	Mensa	H	Sidebar Incase	F	Velocity	D
Chipper	I	H2O	J	Method	G	Sidestep	F	Venue	D
Cinch	B	Habit	C	Millennium	B	Signet	I	Via	C
Cite	G	Hearsay	H	Mix	I	Silica	F	Viva II	E
Clang	D	Helm	F	Molto	H	Silica Andy	G	Vox	B
Classique	J	Hickory Leaf	D	Nagoya	H	Silica Breeze	G	Wander	F
Context	B	Hive	E	Neon	H	Silica Deflect	G	Waver	E
Core	B	Hue	C	Nifty	D	Silica Etch	F	Waypoint	C
Course	G	Hula	H	Nile	H	Silica Fiona	G	Weaving Palettes	F
Cover Cloth	C	Icon	D	Nimble	H	Silica Fritz	G	Whim	F
Crete	H	Idyll	G	Oath	E	Silica Hiatus	G		
Current	C	Illumina	I	Odyssey	B	Silica Hoop	G		

## Pallas Fabric Grading

For memo samples call email [www.pallastextiles.com](http://www.pallastextiles.com)

Grades and availability of fabric are subject to change without notice. Changes could include but are not limited to price increases, discontinued patterns, discontinued colors, etc. See [jsifurniture.com](http://jsifurniture.com) for updated information.

Pattern	Grade	Pattern	Grade	Pattern	Grade
Abstract Chevron	F	Kwaart	G	Turtle Neck	G
Algorithm	F	Laced Up	E	Twine	D
Amari	F	Larkspur	G	Unraveled	E
Asha	F	Latifolia	G	Unspun	G
Aurora	F	Le Fleur	F	Urbanized	E
Basaltes	F	Line	F	Vespa	E
Bevel	F	Majolica	G	Whim	E
Bonnaroo	F	Marbles	F	Wonder Wheel	H
Boulevard	F	Meadowrue	F	Work Horse	F
Bounce	E	Melody Maker	F		
Busy Bee	H	Milano	G		
Carnivale	G	Modern Blaze	F		
Cell Theory	I	Mosaic	E		
Chakra	F	Off Track	E		
Chitra	E	On The Fringe	H		
Chroma	G	Painted Stripe	G		
Composition	G	Patina	E		
Criss Crossing	F	Perfect Pitch	F		
Curve	H	Petals	G		
Dapple	E	Ping Pong	E		
Deeply Rooted	H	Point	F		
Deflect	E	Polka Dotty	F		
Delphinium	G	Promenade	F		
Dot Dot Dot	G	Racy	F		
Field Play	G	Raku	F		
Flame	F	Ravenna	G		
Flexing Muscles	F	Reel To Reel	G		
Formula	G	Reverb	G		
Fortune Teller	F	Rooftops	G		
Fracture	G	Round	I		
French Crepe	F	Running Stitch	H		
Friendship Bracelet	E	Sandstone	D		
Gather	E	Seeking Truth	G		
Gene Pool	G	Sheepish	F		
Graph	D	Skip	E		
Grasmere	F	Solid Footing	E		
Grid	F	Spin Art	G		
Grill Cloth	G	Spontaneous	I		
Ground Breaking	F	Spot On	F		
H2O	F	Spun	E		
Hand-Woven	F	Stamped Out	I		
Heritage	E	Stereo Stripe	G		
Highway Patrol	E	Surface	E		
Hitch	F	Swing	F		
Holy Cow	E	Tempo	E		
Holy Cow Too	E	Terra	D		
Infinite Helix	G	The Burbs	F		
Inlay	F	Top Color	F		
Interlace	G	Transom	G		
Jacks	H	Trellis	H		
Karoke	F	Tulips	G		

## Stinson Fabric Grading

For memo samples call Stinson at 800-841-6279

Grades and availability of fabric are subject to change without notice. Changes could include but are not limited to price increases, discontinued patterns, discontinued colors, etc. See jsifurniture.com for updated information.

Pattern	Grade	Pattern	Grade	Pattern	Grade	Pattern	Grade	Pattern	Grade		
Abacus	G	Channel	D	Flex	E	Liquid	E	Respite	F	Tendrill	D
Acadia Epingle	I	Chauncey	D	Flight	G	Makeover	G	Retrograde	D	Tessellate	G
Acanthus	H	Chi w/Agion	G	Flip Flops	G	Mali	G	Revolution	G	Tessuto	C
Ace	C	Chloe	F	Florentine	G	Malta	I	Revolve	H	Thicket	D
Acrobat	G	Chroma	E	Folio	G	Manchester	E	Rialto	C	Torus	F
Adirondack	F	Cielo	H	Fractal	F	Marimba	F	Riddle	D	Tracing	E
Aero	F	Cinnamon Blossom	H	Freehand	E	Marquetry	F	Rivera	F	Tranquility	H
Affinity	F	Cirque	E	Furrows	D	Martini	F	Rogue II	B	Transcend	C
Alchemy	E	Cirro	F	Fuse	C	Matrix	E	Rolling Stones	H	Trax	D
Alfresco	G	Citadel	C	Geodesic	G	Mesa	H	Salinas	I	Tribeca	C
Algiers	G	Clean Slate	D	GeoMet	E	Metro	D	San Simeon	G	True Path w/Agion	H
Alignment	G	Coco	F	Glacier	C	Mica	D	Satellite	D	Tuscan Hills	H
All American	B	Colden	F	Glisten	H	Mingle	F	Scintillate	G	Tweed	F
Aloha	H	Colorguard All	C	Gradation	E	Moccasin	C	Scout	C	Umbrian Rain	H
Apex.Crypton Revl	E	Seasons	C	Grand Sierra	C	Modena	F	Scribe	D	Up Tempo w/Agion	H
Arc	F	Comeback	G	Gravity	E	Monhegan	G	Script	D	Urban Grid	C
Archetype	E	Concentric	G	Grille	D	Montage	E	Seagrass	G	Valise	D
Arioso	E	Connect	C	Grove	G	Montana	C	Sebago	F	Vanish	H
Ascend	F	Continuum	E	Hands On	F	Moxie	F	Second Act	G	Vapor	F
Aspen	F	Core	C	Happy Hour	E	Mumbai	G	Sedona	H	Varati	I
Atlas	C	Cottonwood	G	Happy Tappy	I	Natural World	J	Sentry - HC	C	Vegas	C
Atmosphere	C	Courtyard	H	Haven	E	Naugaleather	C	Sequence	D	Velocity	E
Auberge	H	Cozy	E	Helix	H	Naugasoft	C	Shantung	C	Verdure - Envi	F
Aura	I	Cranbrook Loop	J	Hi-Fi	D	Neochrome III	C	Shift	C	Vermont	H
Avant	C	Criss Cross	C	Highlight	C	Nest	H	Sideline	E	Vibe	F
Balance Beam	G	Cruisin	H	Hive	D	New Hempstead	C	Silverado w/Agion	F	View	H
Bali	F	Crypton Suede	D	Horizons	H	Next Scene	F	Simplicity	C	Vineyard	I
Balustrade	H	Crystalline	G	Hot Spot	F	Nimble	F	Skyline	G	Vintage	H
Bambu-Envi	F	Curves Ahead	G	Hourglass	G	Nishiki	C	Sleek	D	Vision	C
Banyan	F	Cyma	H	Hudson	G	Nova	E	Sleeping Bear Dunes	F	Voltage	H
Bari	F	Daddy-O w/Agion	G	Hush	F	Now & Zen w/Agion	I	Smile	G	Volterra-Hc	H
Bass Line	G	Dakota	D	I Spy	H	Olympus	F	Smoothie	C	Vortexia	I
Beatbox	F	Dart	C	Impression	H	On The Money	F	Snuggle	E	Walk the Line	J
Beep Beep	G	Dash	D	Inside Track	D	Orbit	D	Solitaire	D	Whirl	G
Bespoke	E	Deflection	G	Interplay	F	Oscillate	I	Spark	J	Whisper	C
Bistro	C	Delphi	F	Interval	E	Outlander	D	Sphere	E	Whitney	F
Blip	C	Detail	G	Isabella	H	Oxford	C	Spindles	H	Willow Talk	H
Block Party	F	Deza	I	Jala	I	Pacifica	G	Spirit Millennium	C	Wink w/Agion	F
Bon Voyage	J	Diffusion	I	Jam Session w/Agion	I	Panorama	J	Splash	F	Wish	I
Bongo	H	Diva	D	Jambi Stripe	G	Park Avenue	F	Sprint	C	Wyatt	D
Breton	G	Dodgeball	G	Jasmine Screen	F	Patriot Plus II	C	Squire	E	Ybor	F
Brilliant	D	Double Time w/Agion	I	Jump w/Agion	I	Peninsula Mohair	I	Stat-Con	E	Ziggy	C
Bryant Park	C	Duet	E	Juxy	F	Perimeter	D	Stellar	D	Zodiac	D
Bubblerake	G	Dynasty	C	Kambala	I	Persuasion	E	Sterling w/Agion	F	Zoom	E
Budget Black	A	E'lan-HC	H	Kennebunk	F	Petals	G	Stipple	D		
Burkshire	C	Effervescense	F	Ketana	H	Pivot	C	Stitch In Time	D		
Calibration	F	Elderberry	G	Kilkenny Tweed	C	Polka	E	Straight and Narrow	G		
Calla	G	Eli	F	Kinetic	F	Portico	F	Strand	C		
Camino	H	English Pub	C	Knock Knock	I	Posh	E	Stratford	I		
Cannon Beach	H	Entrada	G	Kusari	D	Prisma	F	Sumatran Palm	H		
Canterbury	G	Equinox	F	Labyrinth	G	Profile	E	Summit	E		
Capreni	F	Excursion	E	Laredo	C	Promenade	E	Sunburst	G		
Carlisle	D	Expressions	C	Latitude	D	Queue	F	Sundance	E		
Casablanca	I	Facet	D	Lava	H	Radiance	H	w/Stakleen			
Cassidy	C	Fast Lane	D	Leaps & Bounds	F	Raffia	E	Sunswept	I		
Catalina	F	Fenestra	H	Lift	G	Rainier	C	Supersillyness	I		
Catalyst	C	Figment	H	Lindley Park	D	Rally	B	Swivel	G		
Catwalk	F	Finite	E	Line Dance	F	Raquette	G	Symmetry	H		
Celeste	J	Firefly	G	Links	G	Realm	E	Symphony Classic	C		
Chakra	H	Fizz	E	Linus	F	Refraction	C	Tender	H		



Ultrafabrics.

Effective January 1, 2016 ▲



▲Updated 1/21/16

# Ultrafabrics Fabric Grading

For memo samples at Ultrafabrics email [charlotteakirby@yahoo.com](mailto:charlotteakirby@yahoo.com)

Grades and availability of fabric are subject to change without notice. Changes could include but are not limited to price increases, discontinued patterns, discontinued colors, etc. See [jsifurniture.com](http://jsifurniture.com) for updated information.

<u>Pattern</u>	<u>Grade</u>
Brisa	E
Brisa Distressed	E
Brisa Fresco	E
Buffalina	E
Eco Tech	E
Hammered	E
Metro Tech	E
Patine	E
Raffia	E
Ultraleather	E
Ultraleather Fusion	E
Ultraleather Fusion Shimmer	E
Ultraleather Linen	E
Ultraleather Pearlized	E
Ultraleather Pony	E
Ultraleather Pro	F
Ultraleather Promessa	E
Ultraleather Uccello	E
Ultratech	E
Viva	E

INFORMATION

Effective January 1, 2016 ▲

## Wollsdorf Leather Grading

For memo samples call Wollsdorf at 336-884-5005

Grades and availability of leather are subject to change without notice. Changes could include but are not limited to price increases, discontinued patterns, discontinued colors, etc. See [jsifurniture.com](http://jsifurniture.com) for updated information.

<u>Pattern</u>	<u>Grade</u>
Alpine	L2
Atlantic	L2
Euroglazed	L2
Finesse	L2
FOC Earth Black	L2
FOC Earth Colors	L2
Genoa	L2
Mammut	L1
Oslo	L2
Paloma	L2
Prima	L2
Pull Up	L2
Sattel	L2
Sedona	L2

## Specification Tools

JSI products are manufactured to order and provide a multitude of options to address your individual customer needs. As you process your order do not forget to include all the necessary information to allow the order entry process to be completed. Please see the order checklist at the beginning of every series.

JSI Customer Service edits every order for complete information. If details are not included with the purchase order, Customer Service will contact you to answer these questions. If information is not completed in a timely manner it will delay the entry process and could effect your product delivery date. To avoid delay in order entry and potential delay in delivery of your order, please double check the line items to ensure all selections have been completed.

To ensure completion of details on your purchase order, electronic catalogs and specification tools have been developed to aid in the process. These electronic tools include:

**20-20 GIZA Studio and 20-20 CAP Studio** software offers state-of-the-art design, specification, photo-realistic rendering and three-dimensional visualization capabilities for configurable products in the commercial interior design markets. 20-20 GIZA Studio and 20-20 CAP Studio are available for all JSI Casegood and Seating products, in 2D and 3D graphics and the Specifier Catalog. Updates are made monthly reflecting any changes that occurred. To be sure the most up to date information is provided on orders, users of this software program are responsible to update their catalogs.

**ProjectMatrix, Inc.** offers a full software solution for the contract furniture industry. Their software can help you create space plans to specifications for ease of specifying our JSI Casegood and Seating product lines. Updates are made monthly reflecting any changes that occurred. To be sure the most up to date information is provided on orders, users of this software program are responsible to update their catalogs.

**GSAdvantage** is a Federal Government electronic catalog site offered to assist GSA customers in specifying and pricing JSI product. Listed at this site are all contract items and prices under GSA Contract # GS-28F-0030U.

Our JSI website [jsifurniture.com](http://jsifurniture.com) provides many tools to assist in the design and order selection. Included in the site are downloadable images, typicals, product symbols, brochures, contact information, price lists, sales representative locations, warranty and environmental information.

# GSA Terms and Conditions



## Contract Holder

Contract # GS-28F-0030U

### Business Size

Large Business

### Point of Production

Ferdinand, Dubois County, Indiana  
 French Lick, Orange County, Indiana  
 Jasper, Dubois County, Indiana  
 Paoli, Orange County, Indiana

### Pricing

All prices shown are list prices (freight included)

### Discount

Discount 61.6%\* off list.

\*Discount for CaseWorks, Reflections, Walden and Wellington is 61.71% off list.

### Quantity Discounts

Not applicable.

### Prompt Payment Terms

1% 15 - net 30 days from date of invoice.

### Government Commercial Credit Cards

Accepted. No additional discount offered.

### Foreign Terms

Not applicable.

### Delivery Time

30-75 days after receipt of order, 90 days maximum.

### Overnight and 2-day Delivery

Not applicable.

### Urgent Requirements

Contact Customer Service if faster delivery is required.

### F.O.B. Points

F.O.B. destination, freight prepaid and allowed to 48 contiguous states and Washington D.C. excludes special delivery requirements.

### Ordering Address

JSI  
 Attn: Participating Dealer  
 225 Clay Street  
 Jasper, IN 47546  
 Fax: 812-482-1548  
 Phone: 800-457-4511  
 Email: orders@jaspergroup.us.com

### Product Modifications

We willingly accept customers' modifications to standard products. See product modifications information by series at the start of each series under the "Product Modification" sections. If there is a modification you desire that is not listed in this section, please call Customer Service for a modification quote/price.

**In addition to the standard terms and conditions, the following terms and conditions apply to GSA contract.**

### Contract Number

GS-28F-0030U

### Contract Period

September 23, 1999 - June 24, 2018

### Statement of Intended Use

The furniture covered by special item numbers 711-8, 711-9, 711-11, 711-16, 711-17, 711-18, 711-19, and 711-95 is intended for use by Government executives (or equivalent military rank) in the executive, judicial, and legislative branches or armed forces of the federal government. To help customers make a good purchasing decision based on their needs and budget, GSA has established four grades of furniture: Grade (1) includes furniture that tends to be the most expensive on this schedule, Grade (2) furniture tends to be more moderately priced and Grades (3) and (4) furniture tend to be affordable pricing when compared to grades (1) and (2). The ordering agency or service is responsible for determining furniture appropriate for use in its offices which will fit within budget and comply with applicable federal or internal agency procurement regulations.

### Description of Special Item Numbers SIN#

711-8 Executive office furniture  
 711-9 Executive conference room furniture  
 711-11 Tables, occasional and conference  
 711-16 Upholstered seating  
 711-17 Multiple seating  
 711-18 Multi purpose seating  
 711-19 Stacking chairs and dollies  
 711-95 Installation services (not to exceed 12% of net prices for projects where installation costs are \$500 or less.) Installation costs over \$500 are negotiated on a case by case basis.

### Maximum Order

711-8 \$500,000 (five hundred thousand dollars) net  
 711-9 \$500,000 (five hundred thousand dollars) net  
 711-11 \$500,000 (five hundred thousand dollars) net  
 711-16 \$300,000 (three hundred thousand dollars) net  
 711-17 \$200,000 (two hundred thousand dollars) net  
 711-18 \$200,000 (two hundred thousand dollars) net  
 711-19 \$200,000 (two hundred thousand dollars) net  
 711-95 \$150,000 (one hundred fifty thousand dollars) net

### Minimum Order

\$100 (One hundred dollars) net

### Geographic Coverage

48 contiguous states and Washington D.C.

# GSA Terms and Conditions

## Payment Address

JSI  
225 Clay Street  
Jasper, IN 47546

## Warranty Provision

JSI's commercial 15 year warranty applies. See page 3. ▲

## Export Package Charges

Quoted on project-by-project basis.

## Terms of Government Commercial Credit Card Acceptance

Accepted.

## Rental, Maintenance, and Repair

Not applicable.

## Installation

Contact dealer or installation representative.

## Repair Parts

Not applicable.

## Service and Distribution Points

National distribution.

## Participating Dealers

Contact JSI customer service at 800-457-4511.

## Preventive Maintenance

Not applicable.

## Environmental Attributes

JSI is committed to protecting the environment. For JSI's complete environmental information, contact the GSA Customer Service at 800-457-4511. Go to [jsifurniture.com](http://jsifurniture.com) for additional information.

## Duns #

00-636-7767

## Notification Regarding Registration in SAMS Database

Name: Jasper Seating Company, Inc.  
Cage code: 31881

## Acceptance, Modification, Assignment

By placing this order for furniture, material or other products (sometimes collectively referred to as "goods"), customer agrees to these terms and conditions which shall prevail over inconsistent provisions in any other form or document of customer. No change or modification shall be applicable unless set forth in writing and signed by company. Neither this order nor any interest therein shall be assigned by customer except with the prior written consent of company.

## Payment

Customer agrees to pay to company the amount indicated on the invoice, 1% 15 days, net 30 days from date of invoice (U.S.funds only), for goods ordered. Interest will be charged after 30 days from the date of invoice at the rate of one and a half percent (1.5%) per month. International sales will require additional payment arrangements. No goods shall be sold on consignment or conditional sales basis. Payment for the goods delivered hereunder shall constitute acceptance thereof.

## Attorneys' Fees

Customer shall be responsible for all expenses and cost in connection with the enforcement by company of these terms and conditions and the cost of collection (including the fees of any collection agencies to whom the customer's account may be referred), plus reasonable attorneys' fees (which attorneys' fees shall not be less than 25% of the amount due, unless a lower amount is specified by applicable law).

## Remedies

The remedies herein reserved shall be cumulative, and additional to any other or further remedies provided in law or equity. No waiver of a breach of any provision of these terms and conditions shall constitute waiver of any other breach or of such provision.

## Insolvency

Company may forthwith cancel this order in the event of the happening of any of the following or any other comparable event: insolvency of the customer, the filing of a voluntary petition in bankruptcy, the filing of any involuntary petition to have customer declared bankrupt provided it is not vacated within thirty (30) days from the date of filing, the appointment of a receiver or trustee for customer provided such appointment is not vacated within thirty (30) days from the date of such appointment, or the execution by customer of an assignment for the benefit of creditors.

## Limitation of Liability

The Company shall not under any circumstances be liable to the customer, owner of the goods or any third party for special, indirect, incidental, or consequential damages, including, without limitation, loss of profits or revenues, loss or damage to other property or equipment, cost of capital or of purchased or replacement goods, or expense, delay, or inconvenience cause by or arising from the purchase, sale, use, repair or inability to use the goods or by any performance or non-performance under, or breach of, these terms and conditions. The Company's sole liability for any defective goods shall be its repair or its replacement pursuant to the express warranties set forth above, or if amended, as applicable at the time of manufacture or repair of the goods. Some states do not allow the exclusion or limitation of incidental or consequential damages, so the above limitations or exclusion may not apply to all customers. Any action resulting from any breach on the part of company as to the goods or services delivered here under must be commenced within one year after the cause of action has occurred.

## Returns and Allowances

Reasonable touch-up and deluxing is the dealer's responsibility. The Company will not make allowances for trip or delivery charges, but will only make allowance for actual work performed to correct manufacturing defects. Allowances maybe authorized only by a company officer. It is the responsibility of the field sales representative to inspect any defective merchandise and make suggestions and recommendations as to the proper disposition. Field personnel cannot obligate or bind the company by definite agreement, without final authorization by a company officer. Company will not accept automatic charge backs which do not have prior authorization. All defects must be called to the company's attention upon arrival at the customer's "ship to" destination. To initiate any type of claim or request for parts, it is imperative to have the model number or fabric number, which may be located on the tag attached to the frame of the unit. Authorization for return to the company via a return goods authorization. Company will not issue credit allowances for any repairs without company's prior consent. Under no circumstances shall the company accept COD (cash on delivery) returns, and any such shipment will be refused.



## GSA Terms and Conditions

### Security Agreement

The Company may require and customer shall grant a security interest in goods sold pursuant to any credit the company may extend to the customer.

### Governing Law

All disputes between the parties, whether or not arising out of these terms and conditions, will be governed by the laws of the state of Indiana. Customer agrees to submit to the jurisdiction of and agrees all lawsuits relating to any disputes between the customer and the company will be brought only in a state court located in Dubois County, Indiana or the United States District Court for the Southern District of Indiana. The customer hereby waives the right to a trial by jury in any action, proceeding, claim, or counterclaim whether in contract or tort, at law or in equity, arising out of or relating in any way to these terms and conditions and all other disputes between the parties.

### Mitigation

If the company repossesses the goods prior to payment by the customer of all amounts due hereunder, the company may sell the goods, as is, where is, free and clear of all rights of the customer at either public or private sales, and apply the net proceeds (after deducting expenses of repossession and sale) to the obligation of customer hereunder. The customer may dispose of the goods in any commercially reasonable place and manner and the customer waives any notice of time, place and manner of sale.

### Integration

This order for goods, including these terms and conditions, along with any credit application, invoice, statement, dealer contract, acknowledgment, bill of lading (and any exhibits, addenda or amendments thereto) of which this order may be a part, constitutes the sole and complete agreement between the company and the customer with respect to the purchase of the goods.

### Dimensions/Specifications/Finishes

All dimensions are approximate and may vary due to the upholstery technique of each craftsman. If exact dimensions are required, it is necessary for the customer to state such specifications with the order. Detailed specifications sheets are available for each series of goods, and customer should consult the company's customer service department for these specification sheets. Company reserves the right to make changes in dimensions, style, or specifications if company believes these changes will improve the goods' quality or appearance. Company reserves the right to substitute hardwoods due to availability at production. Due to the natural characteristics of wood, environmental effects, and material upgrades, the company cannot guarantee exact finish matches on existing goods previously ordered from company. If an exact match to customer's existing goods is required, it must be specified so that the proper procedures can be followed to ensure an acceptable finish. Company will accept no liability for the finish if this procedure isn't followed. Company reserves the right to make changes in a finish formula if company believes the change will improve the quality or appearance of company's goods.

### Company's Performance of Its Obligation

The production and delivery of the goods to the extent delayed or hindered or prevented from the performance by reason of natural disasters, acts of god, strikes, lockouts, labor troubles, inability to procure materials, casualties, failure of power, restrictive governmental laws or regulations, riots, insurrections, acts of terrorism, war or other reason of a like nature not the fault of the company shall excuse for the period of the delay the company's performance and the period for the performance shall be extended for a period equivalent to the period of such delay.







Desks . . . . .	62	Wall Mount Storage . . . . .	149
Modesty Panels . . . . .	65	Overhead Bookcases . . . . .	168
Peninsula Desks . . . . .	73	Storage Tower Applications . . . . .	169
Desk Bases . . . . .	75	Overhead Bridge Storage. . . . .	174
Returns . . . . .	76	Transaction Applications . . . . .	178
Bridges . . . . .	86	Bench Height Applications . . . . .	179
Credenzas . . . . .	88	Freestanding Bench Height Cabinets . . . . .	182
Modular Tops . . . . .	92	Modular Bench Height Cabinets . . . . .	190
Modular Supports . . . . .	92	Modular Tops . . . . .	192
Modular Pedestals . . . . .	97	Bench Height Seat Cushions . . . . .	194
Support Applications. . . . .	98	Bookcases. . . . .	196
Modesty Panel Applications . . . . .	100	Lateral Files . . . . .	198
Overhead Cabinets. . . . .	102	Wardrobes. . . . .	200
Overhead Cabinet Post Supports . . . . .	138	Storage Cabinets . . . . .	202
Tackboards . . . . .	116	Privacy Screens . . . . .	213
Accessories . . . . .	128		

# Vision - Laminate - Overview

## Desks



**Bow Front Double Pedestal**  
Page 62



**Double Pedestal**  
Page 63



**Double Pedestal**  
Page 63



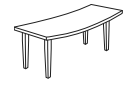
**Electric Adjustable Height Table Desk**  
Page 66



**Pneumatic Adjustable Height Table Desk**  
Page 66

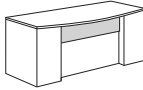


**Crank Adjustable Height Table Desk**  
Page 66

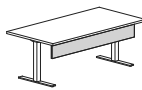


**Table Desk**  
Page 67

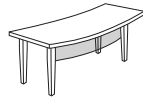
## Modesty Panels



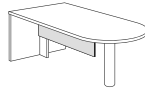
**Trim Modesty Panel**  
Page 65



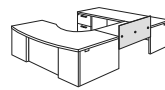
**Adjustable Table Modesty Panel**  
Page 67



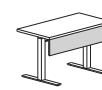
**Trim Modesty Panel**  
Page 67



**Trim Modesty Panel for Peninsula Tops**  
Page 75



**Bridge Panel Screen**  
Page 86



**Adjustable Height Bridge Modesty Panel**  
Page 87

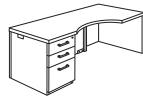
## Desk Applications



**Bow Front Cockpit Pedestal Desk**  
Page 68



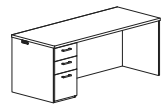
**Bow Front Pedestal Desk**  
Page 69



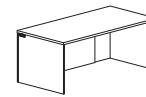
**Cockpit Pedestal Desk**  
Page 70



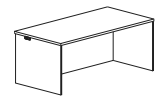
**Pedestal Desk**  
Page 71



**Pedestal Desk**  
Page 71

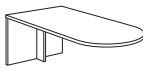


**Shell Desk**  
Page 72



**Shell Desk**  
Page 72

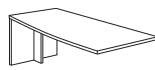
## Peninsula Desks



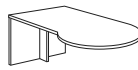
**Bullet Desk**  
Page 73



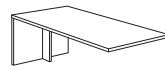
**Cockpit Bullet Desk**  
Page 73



**Fin Desk**  
Page 74

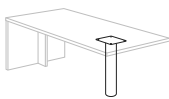


**P-Top Desk**  
Page 74

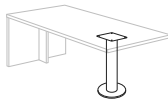


**Rectangle Desk**  
Page 74

## Peninsula Desk Bases and Bullet Return Bases



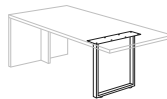
**Column Base**  
Page 75



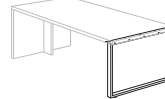
**Column Disk Base**  
Page 75



**H Base**  
Page 75



**U Base**  
Page 75



**Rectangular Base** ▲  
Page 75

## Return Applications



**File/File Return**  
Page 76



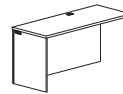
**Box/Box/File Return**  
Page 77



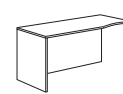
**Lateral File Return**  
Page 78



**Multi-File Return**  
Page 78



**Shell Return**  
Page 79



**Cockpit Shell Return**  
Page 80



**Bullet Return**  
Page 80



**File/File Corner Return**  
Page 82



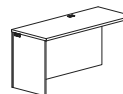
**Box/Box/File Corner Return**  
Page 83



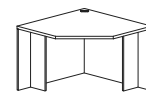
**Lateral File Corner Return**  
Page 84



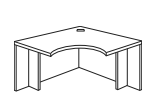
**Multi-File Corner Return**  
Page 84



**Shell Corner Return**  
Page 85

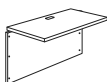


**Corner Unit**  
Page 81



**Cockpit Corner Unit**  
Page 81

## Bridge Applications



**48", 42" and 36" Executive Bridge**  
Page 86



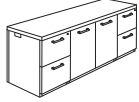
**Electric Adjustable Height Bridge**  
Page 87



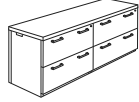
**Pneumatic Adjustable Height Bridge**  
Page 87

# Vision - Laminate - Overview

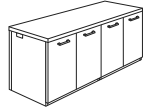
## Credenzas



Storage Credenza  
Page 88



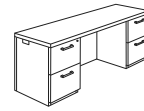
Lateral File Credenza  
Page 88



Four Door Credenza  
Page 88



Two Door Credenza  
Page 88



Kneespace Credenza  
Page 89

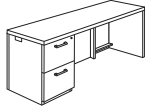


Buffet Credenza  
Page 89

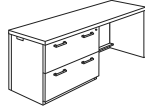


Buffet Credenza  
Page 89

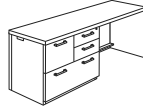
## Credenza Applications



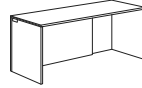
File/File Pedestal  
Credenza  
Page 90



Lateral File Pedestal  
Credenza  
Page 90



Multi-File Pedestal  
Credenza  
Page 91

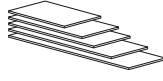


Shell Credenza  
Page 91

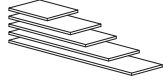
## Modular Top



Modular Bow Front  
Top  
Page 92



Modular Rectangular  
Desk Top  
Page 92



Modular Credenza Top  
Page 93



Modular Extended  
Corner Credenza Top  
Page 94



Modular Return/Bridge  
Top  
Page 94



Modular Extended  
Corner Bullet Top  
Page 95



Modular Extended  
Corner Top  
Page 95



Modular Bullet Top  
Page 96



Modular Boomerang  
Top  
Page 96

## Modular Supports



Metal Legs  
Page 92



Metal Legs  
with Casters  
Page 92



L-Bracket  
Page 92



Full Height T-Support  
Page 96



Bench Height T-Support  
Page 96

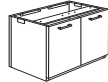
## Modular Pedestal



Modular Box/Box/  
File Pedestal  
Page 97



Modular File/File  
Pedestal  
Page 97



Modular Hinged  
Door Pedestal  
Page 97



Modular Buffet  
Pedestal  
Page 98

## Modular Pedestals



Modular Lateral File  
Pedestal  
Page 98

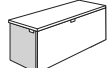


Modular Multi-File  
Pedestal  
Page 98

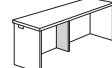
## Support Applications



Wing End Support  
Page 98



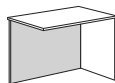
Modular End Panel  
Support  
Page 99



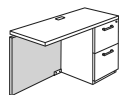
Modular Center  
Support Panel  
Page 100

# Vision - Laminate - Overview

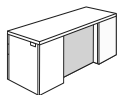
## Modesty Panel Applications



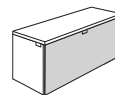
Modular Shell Return Modesty Panel  
Page 100



Modular Return Modesty Panel  
Page 100

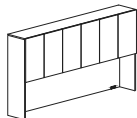


Modular Break Front Desk and Credenza Modesty Panel  
Page 101

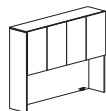


Modular Desk and Credenza Shell Modesty Panel  
Page 101

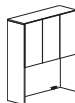
## Overhead Cabinets



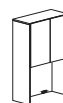
Double Height Storage Overhead Cabinet w/Six Doors  
Page 102



Double Height Storage Overhead Cabinet w/Four Doors  
Page 102



Double Height Storage Overhead Cabinet w/Three Doors  
Page 102



Double Height Storage Overhead Cabinet w/Two Doors  
Page 102



Double Height Storage Overhead Cabinet w/Six Glass Doors  
Page 104



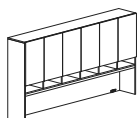
Double Height Storage Overhead Cabinet w/Four Glass Doors  
Page 104



Double Height Storage Overhead Cabinet w/Three Glass Doors  
Page 104



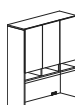
Double Height Storage Overhead Cabinet w/Two Glass Doors  
Page 104



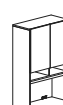
Double Height Storage Overhead Cabinet w/Six Doors and Cubbies  
Page 105



Double Height Storage Overhead Cabinet w/Four Doors and Cubbies  
Page 105



Double Height Storage Overhead Cabinet w/Three Doors and Cubbies  
Page 105



Double Height Storage Overhead Cabinet w/Two Doors and Cubbies  
Page 106



Double Height Storage Overhead Cabinet w/Six Glass Doors and Cubbies  
Page 107



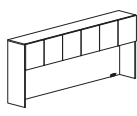
Double Height Storage Overhead Cabinet w/Four Glass Doors and Cubbies  
Page 107



Double Height Storage Overhead Cabinet w/Three Glass Doors and Cubbies  
Page 107



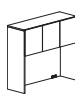
Double Height Storage Overhead Cabinet w/Two Glass Doors and Cubbies  
Page 108



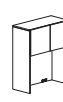
Storage Overhead Cabinet w/Six Doors  
Page 108



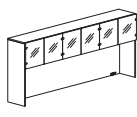
Storage Overhead Cabinet w/Four Doors  
Page 108



Storage Overhead Cabinet w/Three Doors  
Page 108



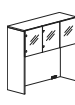
Storage Overhead Cabinet w/Two Doors  
Page 108



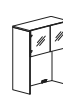
Storage Overhead Cabinet w/Six Glass Doors  
Page 110



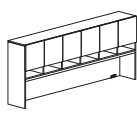
Storage Overhead Cabinet w/Four Glass Doors  
Page 110



Storage Overhead Cabinet w/Three Glass Doors  
Page 110



Storage Overhead Cabinet w/Two Glass Doors  
Page 110



Storage Overhead Cabinet w/Six Doors and Cubbies  
Page 111



Storage Overhead Cabinet w/Four Doors and Cubbies  
Page 111



Storage Overhead Cabinet w/Three Doors and Cubbies  
Page 111



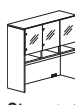
Storage Overhead Cabinet w/Two Doors and Cubbies  
Page 112



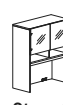
Storage Overhead Cabinet w/Six Glass Doors and Cubbies  
Page 113



Storage Overhead Cabinet w/Four Glass Doors and Cubbies  
Page 113



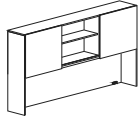
Storage Overhead Cabinet w/Three Glass Doors and Cubbies  
Page 113



Storage Overhead Cabinet w/Two Glass Doors and Cubbies  
Page 114

# Vision - Laminate - Overview

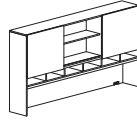
## Overhead Cabinets (continued)



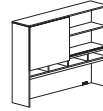
Double Height Storage Overhead Cabinet w/Two Sliding Doors  
Page 103



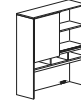
Double Height Storage Overhead Cabinet w/Sliding Door  
Page 103



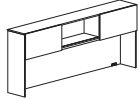
Double Height Storage Overhead Cabinet w/Two Sliding Doors and Cubbies  
Page 106



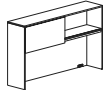
Double Height Storage Overhead Cabinet w/Sliding Door and Cubbies  
Page 106



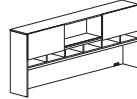
Double Height Storage Overhead Cabinet w/Sliding Door and Cubbies  
Page 106



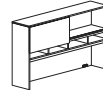
Storage Overhead Cabinet w/Two Sliding Doors  
Page 109



Storage Overhead Cabinet w/Sliding Door  
Page 109



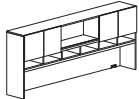
Storage Overhead Cabinet w/Sliding Doors and Cubbies  
Page 112



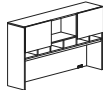
Storage Overhead Cabinet w/Sliding Door and Cubbies  
Page 112



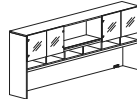
Storage Overhead Cabinet w/Sliding Door and Cubbies  
Page 112



Storage Overhead Cabinet w/Four Doors, Open Center Shelf and Cubbies  
Page 114



Storage Overhead Cabinet w/Two Doors, Open Center Shelf and Cubbies  
Page 114

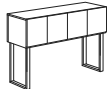


Storage Overhead Cabinet w/Four Glass Door, Open Center Shelf and Cubbies  
Page 115

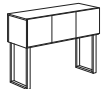


Storage Overhead Cabinet w/Two Glass Door, Open Center Shelf and Cubbies  
Page 115

## Post Support Overhead Cabinets



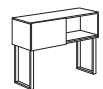
37", 27" and Split Height w/Four Hinged Doors  
Pages 138-140



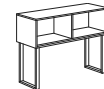
37", 27" and Split Height w/Three Hinged Doors  
Pages 138-140



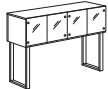
37", 27" and Split Height w/Two Hinged Doors  
Pages 138-140



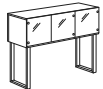
37", 27" and Split Height w/Sliding Door  
Page 141



37", 27" and Split Height Open  
Page 142



37", 27" and Split Height w/Four Glass Doors  
Pages 143-145

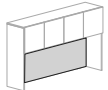


37", 27" and Split Height w/Three Glass Doors  
Pages 143-145

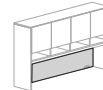


37", 27" and Split Height w/Two Glass Doors  
Pages 143-145

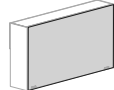
## Tackboards



Tackboard for Front of Storage Overhead Cabinet  
Pages 116-119



Tackboard for Front of Storage Overhead Cabinet w/Cubbies  
Pages 120-123



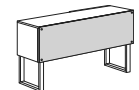
Tackboard for Back of Storage Overhead Cabinet  
Pages 124-127



Accessory Rail Tackboard for Storage Overhead Cabinet  
Pages 130-133



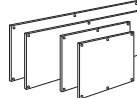
Accessory Rail Tackboard for Storage Overhead Cabinet w/Cubbies  
Pages 134-137



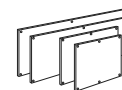
Tackboard for Back of Post Support Overhead Cabinet  
Pages 146-148



Fabric Back Panel for Storage Tower  
Page 173



Wall Mount Tackboards  
Pages 163-165



Wall Mount Tackboards for Overhead Cabinets w/Cubbies  
Pages 166-168

## Accessories



Accessory Rail  
Page 128



Upright Tray  
Page 129



Small Tray  
Page 129



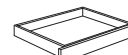
Pencil Tray  
Page 129



Paper Tray  
Page 129



File Hanger  
Page 129



Center Drawer  
Page 214



# Vision - Laminate - Overview

## Wall Mount Storage



Double Height Wall Mount Overhead Shelf  
Page 149



Double Height Wall Mount Open Overhead  
Page 149

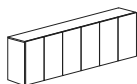


Wall Mount Overhead Shelf  
Page 156

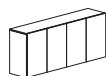


Wall Mount Open Overhead  
Page 156

## Wall Mount Storage



Double Height Wall Mount Overhead Cabinet w/Six Doors  
Page 150



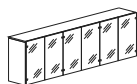
Double Height Wall Mount Overhead Cabinet w/Four Doors  
Page 150



Double Height Wall Mount Overhead Cabinet w/Three Doors  
Page 150



Double Height Wall Mount Overhead Cabinet w/Two Doors  
Page 150



Double Height Wall Mount Overhead Cabinet w/Six Glass Doors  
Page 152



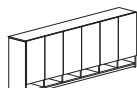
Double Height Wall Mount Overhead Cabinet w/Four Glass Doors  
Page 152



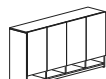
Double Height Wall Mount Overhead Cabinet w/Three Glass Doors  
Page 152



Double Height Wall Mount Overhead Cabinet w/Two Glass Doors  
Page 152



Double Height Wall Mount Overhead Cabinet w/Six Doors and Cubbies  
Page 153



Double Height Wall Mount Overhead Cabinet w/Four Doors and Cubbies  
Page 153



Double Height Wall Mount Overhead Cabinet w/Three Doors and Cubbies  
Page 153



Double Height Wall Mount Overhead Cabinet w/Two Doors and Cubbies  
Page 153



Double Height Wall Mount Overhead Cabinet w/Six Glass Doors and Cubbies  
Page 155



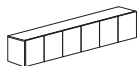
Double Height Wall Mount Overhead Cabinet w/Four Glass Doors and Cubbies  
Page 155



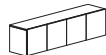
Double Height Wall Mount Overhead Cabinet w/Three Glass Doors and Cubbies  
Page 155



Double Height Wall Mount Overhead Cabinet w/Two Glass Doors and Cubbies  
Page 155



Wall Mount Overhead Cabinet w/Six Doors  
Page 156



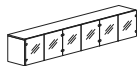
Wall Mount Overhead Cabinet w/Four Doors  
Page 156



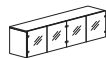
Wall Mount Overhead Cabinet w/Three Doors  
Page 156



Wall Mount Overhead Cabinet w/Two Doors  
Page 156



Wall Mount Overhead Cabinet w/Six Glass Doors  
Page 158



Wall Mount Overhead Cabinet w/Four Glass Doors  
Page 158



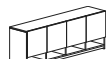
Wall Mount Overhead Cabinet w/Three Glass Doors  
Page 158



Wall Mount Overhead Cabinet w/Two Glass Doors  
Page 158



Wall Mount Overhead Cabinet w/Six Doors and Cubbies  
Page 159



Wall Mount Overhead Cabinet w/Four Doors and Cubbies  
Page 159



Wall Mount Overhead Cabinet w/Three Doors and Cubbies  
Page 159



Wall Mount Overhead Cabinet w/Two Doors and Cubbies  
Page 159



Wall Mount Overhead Cabinet w/Six Glass Doors and Cubbies  
Page 161



Wall Mount Overhead Cabinet w/Four Glass Doors and Cubbies  
Page 161



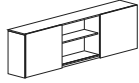
Wall Mount Overhead Cabinet w/Three Glass Doors and Cubbies  
Page 161



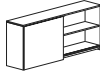
Wall Mount Overhead Cabinet w/Two Glass Doors and Cubbies  
Page 161

# Vision - Laminate - Overview

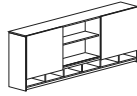
## Wall Mount Storage (continued)



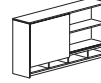
Double Height Wall Mount Overhead Cabinet w/Two Sliding Doors  
Page 151



Double Height Wall Mount Overhead Cabinet w/Sliding Door  
Page 151



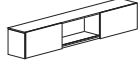
Double Height Wall Mount Overhead Cabinet w/Two Sliding Doors and Cubbies  
Page 154



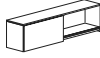
Double Height Wall Mount Overhead Cabinet w/Sliding Door and Cubbies  
Page 154



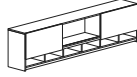
Double Height Wall Mount Overhead Cabinet w/Sliding Door and Cubbies  
Page 154



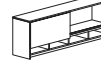
Wall Mount Overhead Cabinet w/Two Sliding Doors  
Page 157



Wall Mount Overhead Cabinet w/Sliding Door  
Page 157



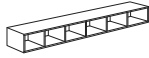
Wall Mount Overhead Cabinet w/Two Sliding Doors and Cubbies  
Page 160



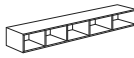
Wall Mount Overhead Cabinet w/Sliding Door and Cubbies  
Page 160



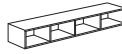
Wall Mount Overhead Cabinet w/Sliding Door and Cubbies  
Page 160



Wall Mount Cubby Six Compartments  
Page 162



Wall Mount Cubby Five Compartments  
Page 162



Wall Mount Cubby Four Compartments  
Page 162

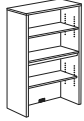


Wall Mount Cubby Three Compartments  
Page 162

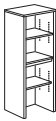


Wall Mount Cubby Two Compartments  
Page 162

## Overhead Bookcase



Double Height Bookcase Overhead  
Page 168



Double Height Bookcase Overhead  
Page 168

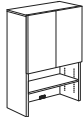


Bookcase Overhead  
Page 170

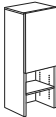


Bookcase Overhead  
Page 170

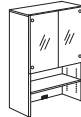
## Storage Tower Applications



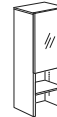
Double Height Storage Tower w/29" h Doors  
Page 169



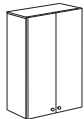
Double Height Storage Tower w/29" h Door  
Page 169



Double Height Storage Tower w/29" h Glass Doors  
Page 169



Double Height Storage Tower w/29" h Glass Door  
Page 169



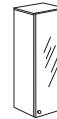
Double Height Storage Tower w/54" h Doors  
Page 170



Double Height Storage Tower w/54" h Door  
Page 170



Double Height Storage Tower w/54" h Glass Doors  
Page 170



Double Height Storage Tower w/54" h Glass Door  
Page 170



Storage Tower w/17" h Doors  
Page 171



Storage Tower w/17" h Door  
Page 171



Storage Tower w/17" h Glass Doors  
Page 171



Storage Tower w/17" h Glass Door  
Page 171



Storage Tower w/42" h Doors  
Page 172



Storage Tower w/42" h Door  
Page 172



Storage Tower w/42" h Glass Doors  
Page 172



Storage Tower w/42" h Glass Door  
Page 172

# Vision - Laminate - Overview

## Overhead Bridge Applications



Double Height Bridge Mount Overhead Shelf  
Page 174



Double Height Bridge Mount Open Overhead  
Page 174



Bridge Mount Overhead Shelf  
Page 176



Bridge Mount Open Overhead  
Page 176

## Overhead Bridge Applications



Double Height Bridge Mount Overhead Cabinet w/Four Doors  
Page 174



Double Height Bridge Mount Overhead Cabinet w/Three Doors  
Page 174



Double Height Bridge Mount Overhead Cabinet w/Two Doors  
Page 174



Double Height Bridge Mount Overhead Cabinet w/Sliding Door  
Page 174



Double Height Bridge Mount Overhead Cabinet w/Four Glass Doors  
Page 175



Double Height Bridge Mount Overhead Cabinet w/Three Glass Doors  
Page 175



Double Height Bridge Mount Overhead Cabinet w/Two Glass Doors  
Page 175



Bridge Mount Overhead Cabinet w/Four Doors  
Page 176



Bridge Mount Overhead Cabinet w/Three Doors  
Page 176



Bridge Mount Overhead Cabinet w/Two Doors  
Page 176



Bridge Mount Overhead Cabinet w/Sliding Door  
Page 176



Bridge Mount Overhead Cabinet w/Four Glass Doors  
Page 177



Bridge Mount Overhead Cabinet w/Three Glass Doors  
Page 177



Bridge Mount Overhead Cabinet w/Two Glass Doors  
Page 177

## Storage Tower Insert/Transaction Support



Horizontal Sorter  
Page 178



Vertical Sorter  
Page 178

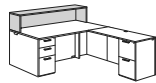
## Transaction Surfaces



Transaction Surface  
Page 178

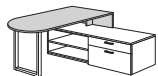


Transaction Trim Panel  
Page 178

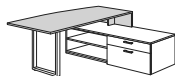


Transaction Counter  
Page 178

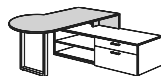
## Peninsula Desks for Bench Height



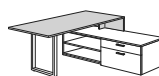
Bullet Desk  
Page 179



Fin Desk  
Page 179

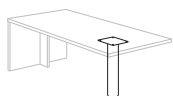


P-Top Desk  
Page 180

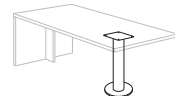


Rectangle Desk  
Page 180

## Peninsula Desk Bases for Bench Height



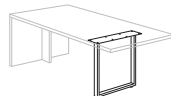
Column Base  
Page 181



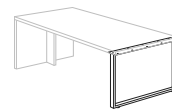
Column Disk Base  
Page 181



H Base  
Page 181



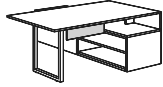
U Base  
Page 181



Rectangular Base ▲  
Page 181

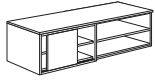
# Vision - Laminate - Overview

## Trim Modesty Panel for Bench Height

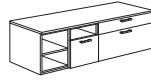


Trim Modesty Panel  
Page 181

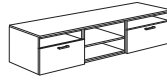
## Freestanding Bench Height Configurations



72" and 60" Bench Height Configurations  
Pages 182-183

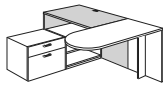


72" Bench Height Configurations  
Page 184

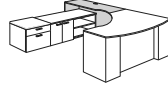


90" Bench Height Configurations  
Page 185

## Shell Return for Bench Height

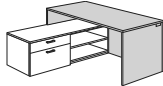


Bench Height Supported Shell Return  
Page 186

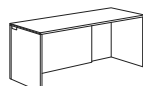


Bench Height Supported Cockpit Shell Return  
Page 186

## Shell Credenzas for Bench Height



Bench Height Shell Credenza  
Page 186



Shell Credenza  
Page 186

## Freestanding Bench Height Cabinets



Box/File  
Page 187



Box/File  
Page 187



Open Shelf  
Page 188



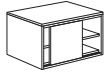
Open Shelf  
Page 188



Open Shelf/File Drawer  
Page 188



Open Shelf/File Drawer  
Page 188



Sliding Door  
Page 188



Hinged Doors  
Page 189



Hinged Door  
Page 189

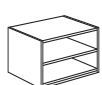
## Modular Bench Height Cabinets



Box/File  
Page 190



Box/File  
Page 190



Open Shelf  
Page 190



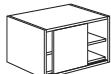
Open Shelf  
Page 190



Open Shelf/File Drawer  
Page 190



Open Shelf/File Drawer  
Page 191



Sliding Door  
Page 191



Hinged Doors  
Page 191



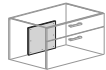
Hinged Door  
Page 191

# Vision - Laminate - Overview

## Top for Modular Bench Height Cabinets



Modular Bench Height Tops  
Page 192



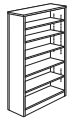
Counterweight  
Page 193

## Bench Height Seat Cushions

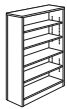


Bench Height Seat Cushions  
Page 194-195

## Bookcases



Bookcase  
Page 196



Bookcase  
Page 196



Bookcase  
Page 196



Bookcase  
Page 196



Bookcase  
Page 196



Bookcase with  
Bottom Doors  
Page 197



Bookcase with  
Bottom Doors  
Page 197

## Lateral Files



Lateral File  
Page 198



Lateral File  
Page 198



Lateral File  
Page 198

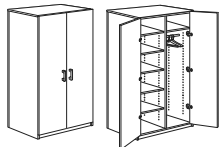


Box/Box/File  
Mobile Pedestal  
Page 199

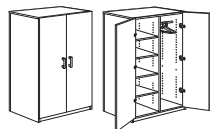


Mobile Lateral File  
w/Cushion Top  
Page 199

## Wardrobes



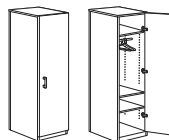
84" h Wardrobe  
Page 200



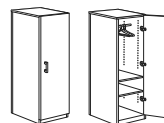
72" h Wardrobe  
Page 200



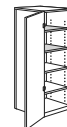
Hanging Bar to Shelves  
Conversion Kit  
Page 200



84" h Wardrobe  
Page 201

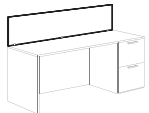


72" h Wardrobe  
Page 201

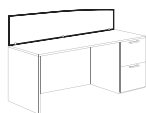


Hanging Bar to Shelves  
Conversion Kit  
Page 201

## Privacy screen



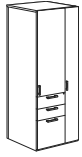
Rectangle Privacy Screen  
Page 213



Fin Privacy Screen  
Page 214

# Vision - Laminate - Overview

## Storage Cabinets



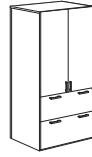
84" h Box/Box/File Storage Wardrobe  
Page 202



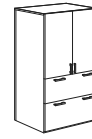
72" h Box/Box/File Storage Wardrobe  
Page 202



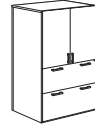
57" h Box/Box/File Storage Wardrobe  
Page 202



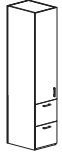
84" h File/File Lateral Storage Cabinet  
Page 203



72" h File/File Lateral Storage Cabinet  
Page 203



57" h File/File Lateral Storage Cabinet  
Page 203



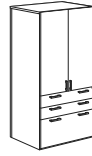
84" h File/File Storage Cabinet  
Page 204



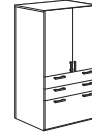
72" h File/File Storage Cabinet  
Page 204



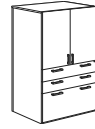
57" h File/File Storage Cabinet  
Page 204



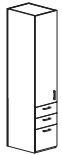
84" h Box/Box/Lateral File Storage Cabinet  
Page 206



72" h Box/Box/Lateral Storage Cabinet  
Page 206



57" h Box/Box/Lateral Storage Cabinet  
Page 206



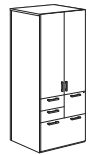
84" h Box/Box/File Storage Cabinet  
Page 205



72" h Box/Box/File Storage Cabinet  
Page 205



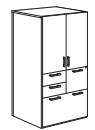
57" h Box/Box/File Storage Cabinet  
Page 205



84" h Multi-File Storage Cabinet  
Page 207



72" h Multi-File Storage Cabinet  
Page 207



57" h Multi-File Storage Cabinet  
Page 207



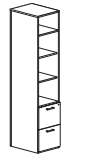
84" h Storage Cabinet  
Page 208



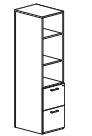
72" h Storage Cabinet  
Page 208



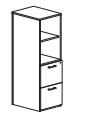
57" h Storage Cabinet  
Page 208



84" h Open Top, File/File Storage Cabinet  
Page 209



72" h Open Top, File/File Storage Cabinet  
Page 209



57" h Open Top, File/File Storage Cabinet  
Page 209



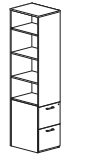
84" h Open Top, Box/Box/File Storage Cabinet  
Page 210



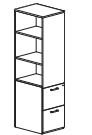
72" h Open Top, Box/Box/File Storage Cabinet  
Page 210



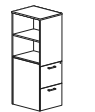
57" h Open Top, Box/Box/File Storage Cabinet  
Page 210



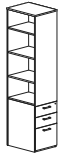
84" h File/File Storage Cabinet w/Side Access  
Page 211



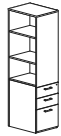
72" h File/File Storage Cabinet w/Side Access  
Page 211



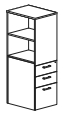
57" h File/File Storage Cabinet w/Side Access  
Page 211



84" h Box/Box/File Storage Cabinet w/Side Access  
Page 212

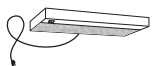


72" h Box/Box/File Storage Cabinet w/Side Access  
Page 212

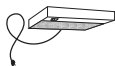


57" h Box/Box/File Storage Cabinet w/Side Access  
Page 212

## Task Lights



48" w Task Light  
Page 412



24" w Task Light  
Page 412



31" w LED Starter Task Light  
Page 412



31" w LED Linking Adder Task Light  
Page 412



17" w LED Starter Task Light  
Page 413



17" w LED Linking Adder Task Light  
Page 413



Motion Sensor for Task Lights  
Page 413

## Vision Laminate Product Information

### Laminates

Vision Laminate features TFL (thermally fused laminate) chassis and components. *Main Worksurfaces\** are available in a HPL (high pressure laminate) or in the TFL surface.

Edges of the worksurface are impact resistant (PVC) on TFL and HPL tops. The laminate is offered in 11 wood grain patterns and 7 solid colors. The wood grain laminate features an embossed grain to hide finger prints and light scratches. The solid laminate is smooth to the touch with a semi-matte finish. All Vision Laminate products are indoor-air certified by GreenGuard.

The chart below lists the laminates available on the Vision product. Former laminate names are listed in parentheses for reference.

#### TFL - HPL Wood Grain Pattern Laminates

AUT Autumn ( <i>Autumn Cherry</i> )	HGL High Line
BLO Blonde Echo	SHE Shea ( <i>Nat Maple/Ale finish match</i> )
BBN Bourbon ( <i>Natural Cherry</i> )	STU Studio Teak
BZW Brazilwood	VIN Vintage ( <i>Vintage Cherry</i> )
BRG Brighton ( <i>Brighton Cherry</i> )	WLH Walnut Heights
GRH Graphite	

#### TFL - HPL Solid Laminates

ALB Alabaster	SHD Shadow
BBL Bridal Blanco	SLG Slate Grey
DWH Designer White	TAU Taupe
DOV Dove Grey	

▲ Laminates available on the **NOW!** quickship program include the following: Autumn (AUT), Blonde Echo (BLO), Bourbon (BBN), Brazilwood (BZW), Brighton (BRG), Designer White (DWH), Shea (SHE), Studio Teak (STU), Vintage (VIN), and Walnut Heights (WLH).

### WorkSurfaces

Worksurfaces have a 3-ply balanced construction. Tops are 1 3/16" thick with coordinating PVC edges. Primary worksurfaces feature 3mm PVC edges on the approach and user sides. Some laminates have a choice of 3 edge profiles, see page 43. *Main Worksurfaces\** are offered in TFL or HPL.

Bridge, return, credenza worksurfaces are profiled with a 3mm PVC edge on the user side only. Remaining edges are banded with 1mm PVC which creates a seamless appearance when units are mated end-to-end or back-to-back.

#### TFL features on *Main Worksurfaces\**

- fused to the 45 pound density substrate of the top for a durable surface
- tops are laminated on both sides
- available in all the wood grain and solid patterns

#### HPL features on *Main Worksurfaces\**

- fusion of multiple layers create a higher impact resistant surface
- tops are 3-ply balanced construction
- matched to the TFL wood grain and solid patterns

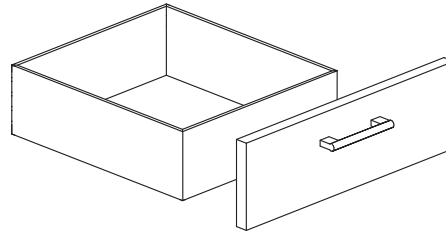
\**Main Worksurfaces include tops on desks, standard height credenzas, returns, bridges and transaction tops. Refer to pricing pages to confirm availability.*

### Case Construction

Panels for chassis consist of a 3/4" thick substrate with TFL surfaces and PVC bands on exposed edges. Pedestals and cabinets are constructed with dowels reinforced with screws, cleats and metal fasteners for increased stability. Leveling glides are set into solid hardwood blocks with t-nuts, which helps to prevent the leveling glide from tear-outs.

### Drawers

The unidirectional V- Fold drawer box is a durable miter-fold drawer structure which is glued and doweled. The 1/2" thick drawer sides are wrapped in a high grade maple vinyl, with an attached front. The drawer front is attached to the four sided box.



### Drawer Suspension

High quality black drawer suspension carries a lifetime warranty. File and box drawers have 100% full extension with over travel. Slides feature steel ball bearings for longer wear and positive, cushioned in/out stops.

### Filing Hardware

All file drawers are constructed with a custom designed for hanging folders. Filing diagram on page 48-52.

### Locking

All desks, returns, lateral files, free standing credenzas, and bench height credenza feature pedestal locking.

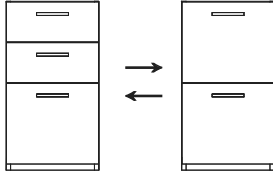
Units are shipped randomly keyed as standard. Key alike units are available upon request for no additional charges. Removable cores for in-field re-keying are standard.

## Vision Laminate Product Information

### Product Modification

#### Pedestal Configuration Change

Desks have one box/box/file pedestal. The pedestal double pedestal has a file/file on right side. Returns and credenzas are configured with file/file pedestals.



Drawer configurations can be changed from either a box/box/file or a file/file configuration, on unit 30" high, but must be specified at the time of order. An additional 5% upcharge needs to be added to the list price of the unit. *(Must keep the same pedestal depth.)*

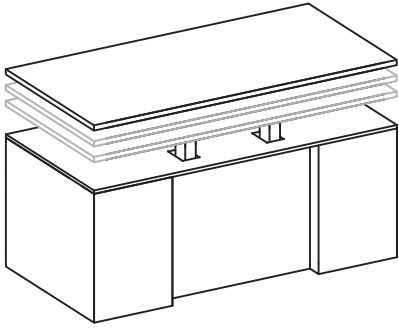
#### Special Construction

Vision Laminate offers large offering to create many types of configuration. Contact Customer Service if you are having trouble with finding the right units to complete the desired configuration. Special request may be denied because of material limitations.



## Vision Laminate Product Information

VISION - LAMINATE



This mechanism requires a signed Liability Wavier prior to time of order specification.

Contact Customer Service or visit our Website at [jsifurniture.com](http://jsifurniture.com)

### ERGO Adjustable Work Height Mechanism

Our proprietary adjustable work height mechanism can be specified on many of the models in Vision Laminate.

ERGO mechanism allows height adjustability to be added to the worksurface. Our solution uses a standardized design that minimizes the modifications required to standard desk, bridge, or credenza models. The mechanism and control box are neatly concealed to maintain the appearance of the original elegance of the product. A push button activates the electric powered lifting columns for adjustability from sitting height to a standing height. A ¾" thick finished sub top is added to the top of the desk chassis for a clean appearance when the surface is in the raised position. In the lowered position, please note that ERGO adds ¾" to the standard height of the desk and the installation will decrease knee space depth by 8".

Automatic Collision Control is built in to each mechanism as a standard feature. When the system senses an obstacle obstructing the movement, the mechanism will reverse direction and retreat by 1".

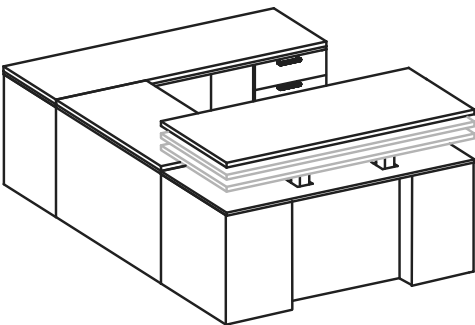
When ERGO is added to a worksurface in an "L" or "U" group, all units in the configuration need to have a sub top added. These units are considered to be ERGO ADJACENT units. ERGO ADJACENT units must have a fixed height worksurface that matches the lowest position of the ERGO mechanism and the top. This is accomplished by adding a ¾" sub top between the chassis and the worksurface. This feature can also be specified for cabinets which may sit next to a unit with the ERGO mechanism.

Height adjustment starts at 30 ¾", to a standing height of 49 ¾", a range of 19 ½".

To specify the unit that has the mechanism, add **ERGO** to the end of the model number.

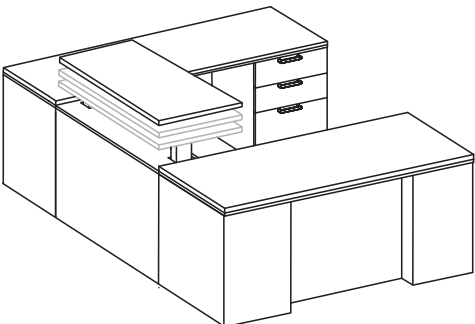
To specify the connecting or adjacent units add, **ERGO ADJACENT** to the end of the model number.

The Ergo mechanism and controls are warranted for a period of (1) year. The rest of the casegood unit(s) are warranted under the normal fifteen (15) year warranty. ▲



#### Example

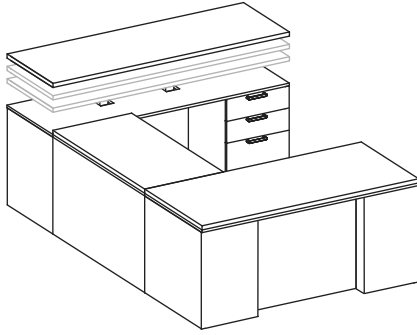
VL3672LD-ERGO	add \$2,888 to list
VL2448EB-ERGO ADJACENT	add \$342 to list
VL2472RC-ERGO ADJACENT	add \$420 to list



#### Example

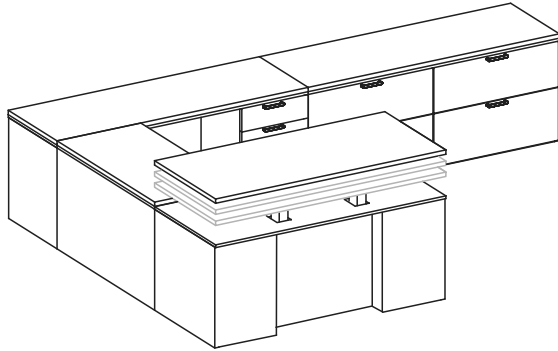
VL3672LD-ERGO ADJACENT	add \$420 to list
VL2448EB-ERGO	add \$2,888 to list
VL2472RC-ERGO ADJACENT	add \$420 to list

## Vision Laminate Product Information



*Example*

VL3672LD-ERGO ADJACENT      add \$420 to list  
 VL2448EB-ERGO ADJACENT      add \$342 to list  
 VL2472RC-ERGO                  add \$2888 to list



*Example*

VL3672LD-ERGO                  add \$2888 to list  
 VL2448EB-ERGO ADJACENT      add \$342 to list  
 VL2472RC-ERGO ADJACENT      add \$420 to list  
 VL2472LFC-ERGO ADJACENT      add \$420 to list

**Availability of Vision Laminate Units with the Mechanism**

The following models are available with the ERGO Adjustable Work Height Mechanism. When specifying, add "ERGO" to the end of the model number.

Double Pedestal Desk	Single Pedestal Desk	Bridges	Credenzas	Returns
Add \$2,888 to the list price.	Add \$2,888 the list price. These units require adjacent products to create "L" and "U" layouts	Add \$2,888 to the list price. These units require adjacent products to create "L" and "U" layouts	Add \$2,888 to the list price. These units require adjacent products to create "L" and "U" layouts	Add \$2,888 to the list price. These units require adjacent products to create "L" and "U" layouts
VL3672BD*	VL3672LBD	VL2448EB	VL2472KC*	VL2448ELCR
VL3672DD*	VL3672RBD	VL2442EB	VL2466KC*	VL2448ERCR
VL3072DD*	VL3672LD		VL2460KC*	VL2448ELR
VL3066DD*	VL3672RD		VL2472LC	VL2448ERR
VL3060DD*	VL3072LD		VL2472RC	VL2442ELCR
	VL3072RD		VL2460LC	VL2442ERCR
	VL3066RD		VL2460RC	VL2442ELR
	VL3066LD		VL2466LC	VL2442ERR
	VL4872CBDL		VL2466RC	
	VL4872CBDR			
	VL4272CLD			
	VL4272CRD			

\* indicates freestanding unit and does not require adjacent products

\* indicates freestanding unit and does not require adjacent products

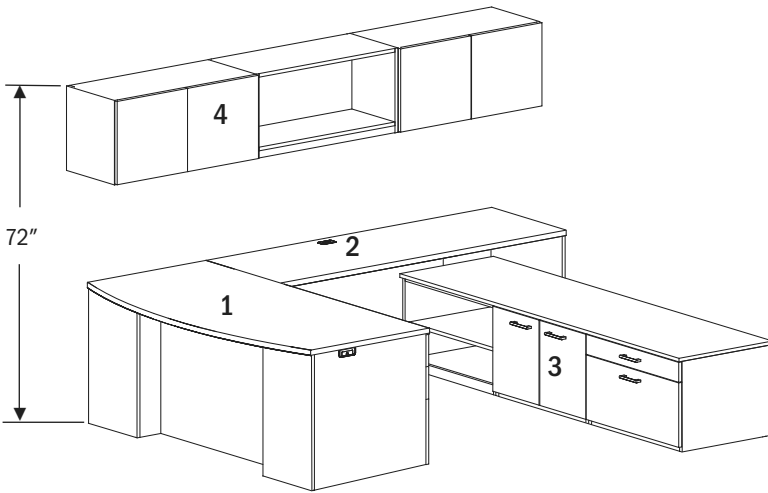
**Connecting or Adjacent Units to Match Starting Height**

All the units listed above can be specified as connecting or adjacent units. Other Vision Laminate units could also be used as connecting units. Please contact Customer Service for additional items and pricing. When specifying, please add "ERGO ADJACENT" to the end of the model number.

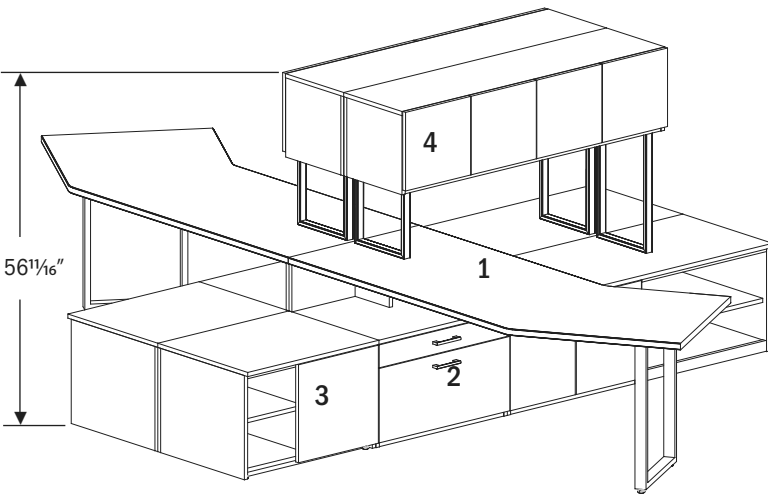
Pricing for Standard Connecting or Adjacent Units  
 Tops larger than 24" x 48" add \$420 to the list price.  
 Tops 24" x 48" or smaller add \$342 to the list price.

# Vision Laminate Product Information

## Layouts



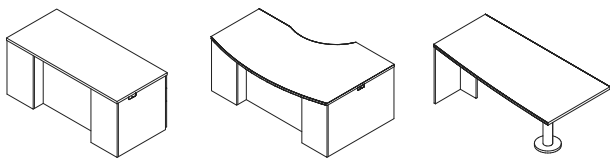
Vision Laminate can be configured in many different ways to achieve the perfect layout.



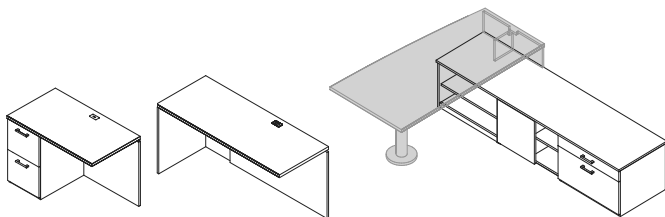
Create open plan or teaming stations with Vision Laminate modular components.

## Easily Specified Layout

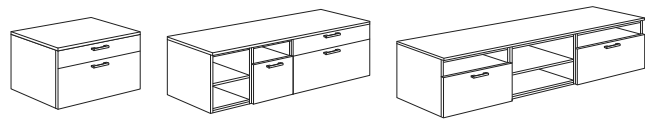
**1 Primary Worksurfaces** are available in traditional desks with pedestals or peninsula worksurfaces with a variety of shapes. The pedestal desks have end panel grommets for wire management.



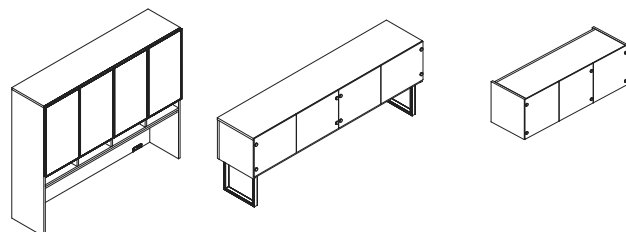
**2 Side Worksurfaces** can be corner shell returns, bench height credenzas, pedestal returns, and adjustable tables. Peninsula desks with bench height support can be specified to work with the bench height credenzas.



**3 Bench Height Credenzas.** Vision Laminate offers a wide range of storage configurations. Modular groups of bench height credenzas can be specified to create unique configurations. Seat cushions are ordered separately from the credenza and allow customers to choose the fabrics.

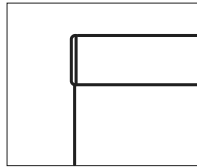


**4 Overhead Storage Cabinets.** Traditional style overheads are available along with post support overheads, which can be used in open plan. Both are available in two heights. Wall mounted overheads can provide a light scale solution.

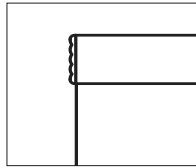


# Vision Laminate Product Information

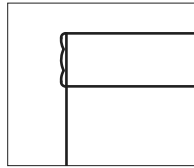
## Top Edge Details



Eased (R3)



Reeded (H3)

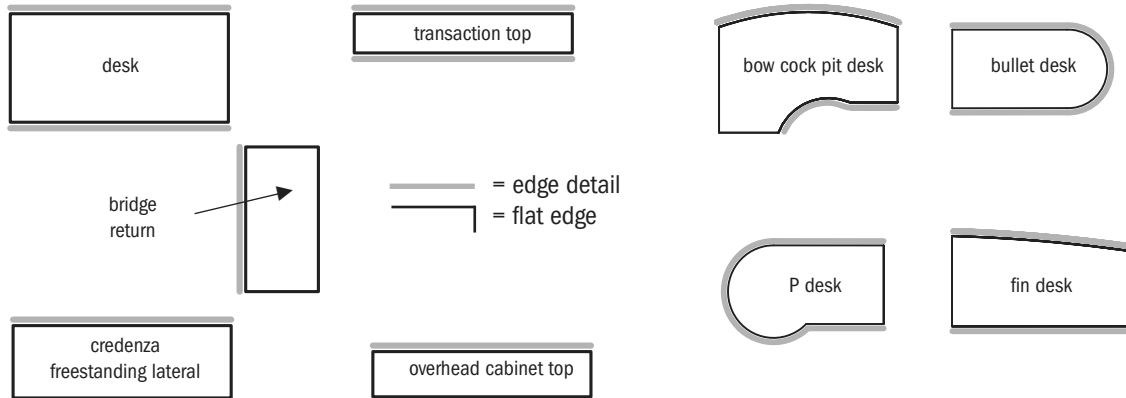


Transitional (C3)

## Edge Detail Availability

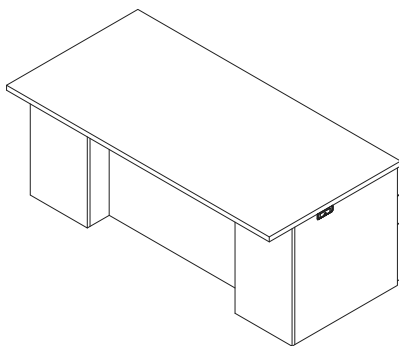
Laminate	Edges	Laminate	Edges
Autumn ( <i>Autumn Cherry</i> )	All	Alabaster	Eased
Blond Echo	Eased	Bridal Blanco	Eased
Bourbon ( <i>Natural Cherry</i> )	All	Designer White	Eased
Brazilwood	Eased	Dove Grey	Eased
Brighton ( <i>Brighton Cherry</i> )	All	Shadow	Eased
Graphite	Eased	Slate Grey	Eased
High Line	Eased	Slate Grey	Eased
Shea ( <i>Natural Maple</i> )	All	Taupe	Eased
Studio Teak	Eased		
Vintage ( <i>Vintage Cherry</i> )	All		
Walnut Heights	Eased		

## Top Edge Detail Location

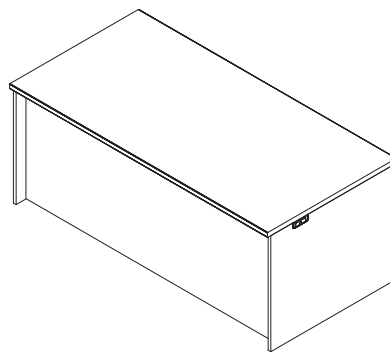


## Approach View of Pedestal Desk

Vision Laminate offers two distinct approach views for desk. Specify a model with either a break front modesty or a recessed modesty. Desk model numbers ending in "F" have the full recessed modesty panel.

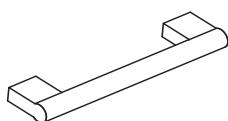


Break Front (model # **VL3672DD**)



Recessed Front Modesty (model # **VL3672DDF**)

## Pull Style and Color Options



**Bar**  
Matte Black (MBK)  
Polished Nickel (PNK)



**Fluent**  
Matte Black (MBK)  
Matte Nickel (MNK)



**Healy**  
Matte Nickel (MNK)



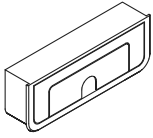
**Revele**  
Matte Nickel (MNK)



**Sweep**  
Matte Black (MBK)  
Matte Nickel (MNK)

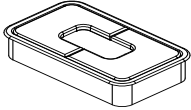
# Vision Laminate Product Information

## Grommet and Color Options



### End/Back Panel Grommet

The end/back panel grommets are standard on desks, returns, standard height credenzas, and modular cabinets with end panels. This grommet is also on back panels of returns and on back panels for overhead cabinets.



### Worksurface Grommet

Worksurface grommets are standard on the bridge, return units, and corner units.

Matte Black (MBK)  
Stardust Silver (STS)

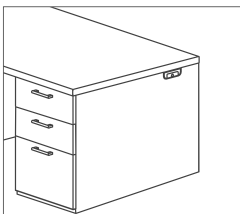
Grommets are available in Matte Black (MBK) or Stardust Silver (STS). Choose one color for all grommets. If no color is selected, grommet color will coordinate with the pull color. Lock cores will match grommet color. Additional grommets can be added. Location must be approved by JSI manufacturing, contact Customer Service.

Add \$79 to the list for each additional grommet.

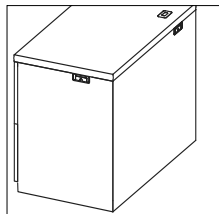
VISION - LAMINATE

## Standard Grommets Locations

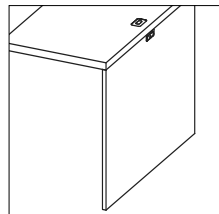
Vision Laminate features grommets for wiring to pass thru the unit.



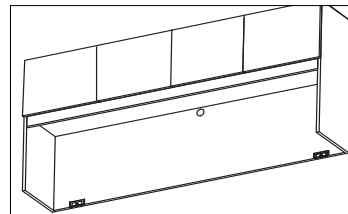
**Desks - Credenza**  
End Panel Grommet



**Returns**  
Work Surface Grommet  
End Panel Grommet  
Back Panel Grommet



**Bridge**  
Work Surface Grommet  
Back Panel Grommet



**Overhead Cabinet**  
Back Panel Grommet  
Back Center Pass Thru

## Wire Management

Wiring can move freely from unit to unit with the standard grommets and out to the building data and power.

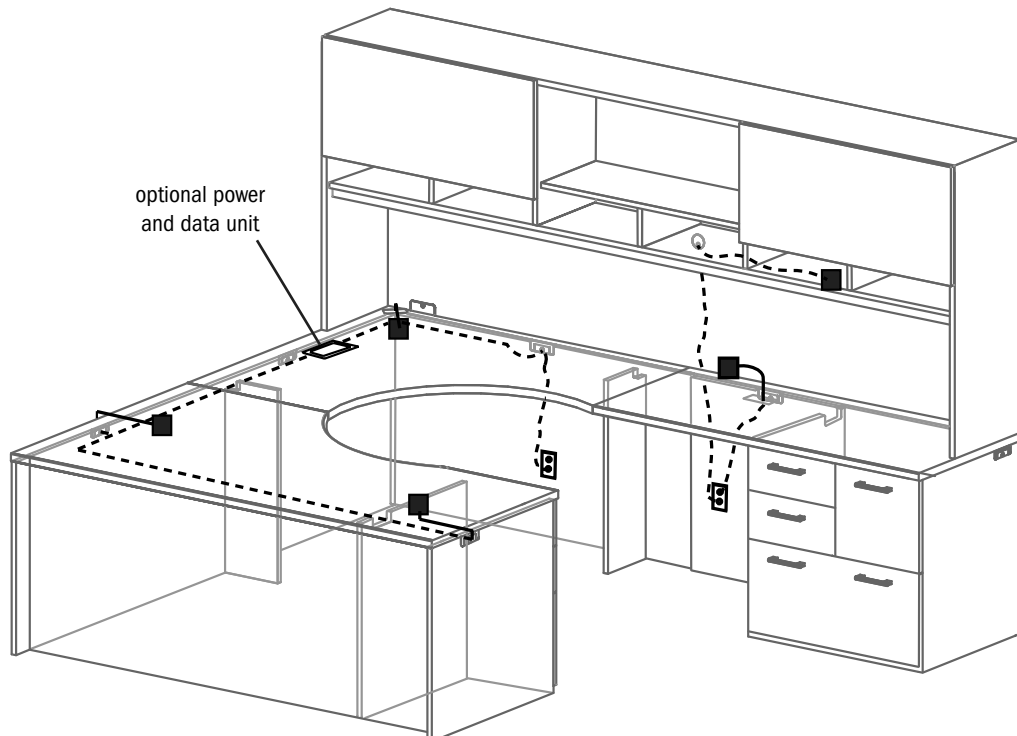
Pedestal desks, credenzas, corners units, bridge panels, return modesty and end panels are standard with end panel grommets.

The end panel grommet opening is 4" wide by 1 7/8" high with a bezel trim secured to the panel with a friction side cap.

Top grommets are standard in returns, bridges and corner units. Additional top grommets may be specified as an option.

Optional power and data units can be positioned in the tops to provide tilt up technology access at the worksurface.

Refer to the accessory section for these items or other accessories items. (see page 407)



# Vision Laminate Product Information

## Peninsula and Modular Top Shapes



**Rectangle**  
peninsula/modular



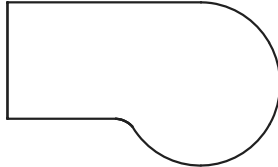
**Bullet**  
peninsula/modular



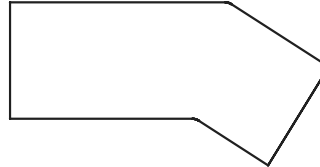
**Extended Corner**  
modular



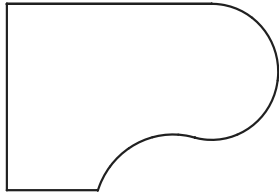
**Fin**  
peninsula



**"P" Top**  
peninsula



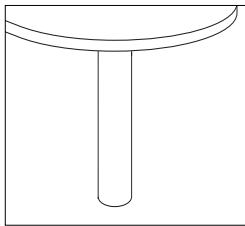
**Boomerang**  
modular



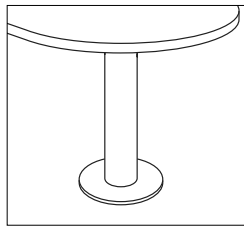
**Extended Corner Bullet**  
peninsula/modular

## Base for Worksurface Tops and Finish Colors Options

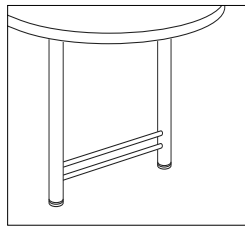
These base styles can be used with Bullet, Cockpit Bullet, Fin, P-Top or Rectangle Peninsula Desk. These base styles can also be used with Modular and Bullet Return Tops.



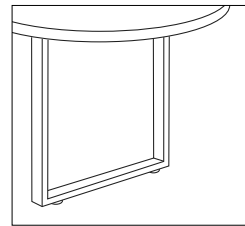
**Column Base**  
Black Sandtex (BSX)  
Stardust Silver (STS)



**Column Disk Base**  
Black Sandtex (BSX)  
Stardust Silver (STS)

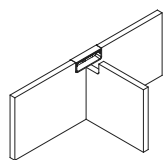


**H Base**  
Black Sandtex (BSX)  
Stardust Silver (STS)

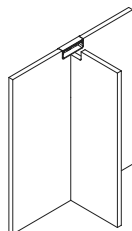


**U Base**  
Black Sandtex (BSX)  
Stardust Silver (STS)

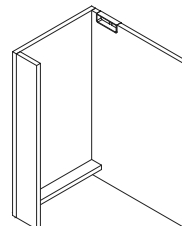
## Modular Top End Supports for Peninsula and Modular Tops



**Bench Height "T" Support**  
use with bench height credenza



**Full Height "T" Support**  
use with peninsula or modular tops

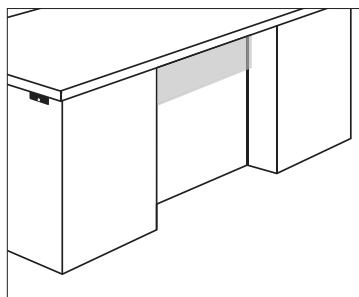


**Wing End Support**  
use to create a modular open corner credenza

# Vision Laminate Product Information

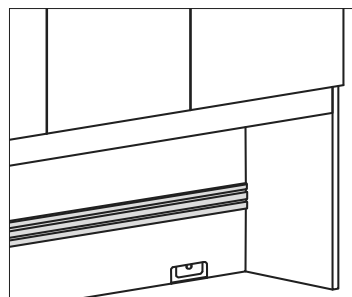
## Product Features and Options

VISION - LAMINATE



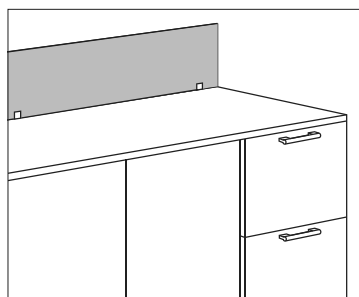
### Trim Modesty Panels

- Mounts in front of existing modesty panel
- Mounts to the underside of the top
- Acrylic Panel - Frosted
- Stainless Steel Puck Style attachment
- Field installed



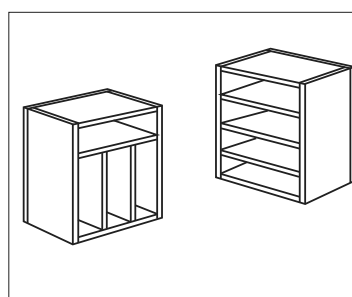
### Aluminum Accessory Rail

- Anodized Aluminum finish
- Accessory Tools (see page 129)
  - Upright Tray
  - Small Tray
  - Pencil Tray
  - Paper Tray
  - File Hanger



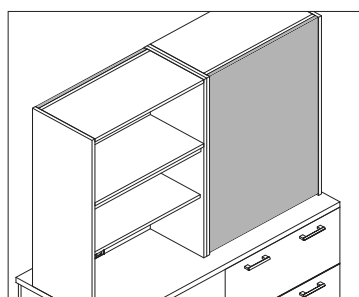
### Privacy Screens

- Mounts to the edge of the work surface
- Acrylic Panel - Frosted
- Attachment hardware is included
- Field installed



### Paper Sorters

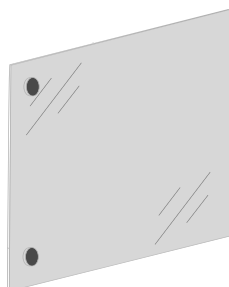
- Can provide support for transaction work surfaces
- Use under overhead cabinet storage
- Field configured - horizontal shelf and vertical shelves or all horizontal shelves



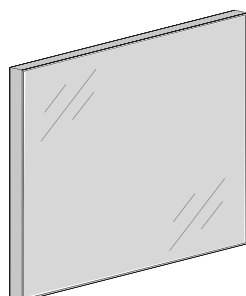
### Fabric Back Panel

- excellent solution for open plan or room dividers
- tackable surface
- standard with Culp Montgomery Sterling panel fabric
- COM or JSI fabric program available
- mounts with covered buttons

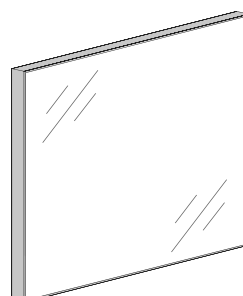
## Glass Door Options for Overhead Cabinets, Storage Towers, and Wall Mounted Cabinets



**Frosted**  
Frameless  
(Frosted glass with acid etched back)



**Frosted**  
Aluminum Frame  
(Frosted glass with acid etched back)



**White Back Painted**  
Aluminum Frame  
(Glossy low iron white back painted glass)

# Vision Laminate Product Information

## Finish and Reference Codes - Summary

Select	Code
<b>Laminate Selections</b>	
Alabaster	ALB
Autumn	AUT
Blonde Echo	BLO
Bourbon	BBN
Brazilwood	BZW
Bridal Blanco	BBL
Brighton	BRG
Designer White	DWH
Dove Grey	DOV
Graphite	GRH
High Line	HGL
Shadow	SHD
Shea	SHE
Slate Grey	SLG
Studio Teak	STU
Taupe	TAU
Vintage	VIN
Walnut Heights	WLH

Select	Code
<b>Drawer Pulls</b>	
Bar - Matte Black	MBK
Bar - Polished Nickel	PNK
Fluent - Matte Black	MBK
Fluent - Matte Nickel	MNK
Healy - Matte Nickel	MNK
Reveal - Matte Nickel	MNK
Sweep - Matte Black	MBK
Sweep - Matte Nickel	MNK

Select	Code
<b>Grommets</b>	
End and Surface - Matte Black	MBK
End and Surface - Stardust Silver	STS

Select	Code
<b>Overhead Cabinet Doors - Glass Options</b>	
Frosted - Frameless	
Frosted - Aluminum Frame	
White Back Painted - Aluminum Frame	

Select	Code
<b>Metal Colors</b>	
Matte Black	MBK
Stardust Silver	STS

Select	Code
<b>Peninsula Supports</b>	
Column Base - Black Sandtex	MSX
Column Base - Stardust Silver	STS
Column Disc Base - Black Sandtex	MSX
Column Disc Base - Stardust Silver	STS
H Base - Black Sandtex	MSX
H Base - Stardust Silver	STS
U Base - Black Sandtex	MSX
U Base - Stardust Silver	STS

### Adjustable Height Table Base Finish

Select	Code
<b>Electric</b>	
Black Sandtex	BSX
Stardust Silver	STS
<b>Pneumatic</b>	
Alloy	ALY
Matte Black	MBK

Select	Code
<b>Crank</b>	
Black Sandtex	BSX
Stardust Silver	STS

Select	Code
<b>Modesty Panel Brackets</b>	
Black Sandtex	BSX
Stardust Silver	STS



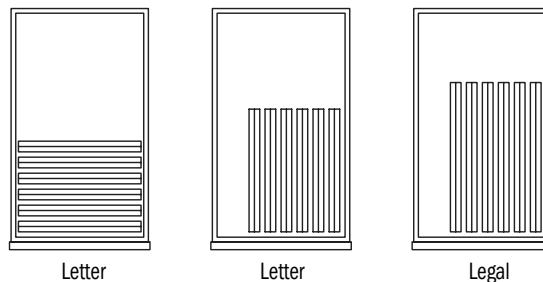
# Vision Laminate Product Information

VISION - LAMINATE

## DESK

Model	Description	Drawer Configuration (User Side)	
		Left Pedestal	Right Pedestal
VL3672BD	Double Pedestal Bow Desk	Box/Box/File	File/File
VL3672DD	Double Pedestal Desk	Box/Box/File	File/File
VL3072DD	Double Pedestal Desk	Box/Box/File	File/File
VL3066DD	Double Pedestal Desk	Box/Box/File	File/File
VL3060DD	Double Pedestal Desk	Box/Box/File	File/File
VL4872CBDR	Right Pedestal Bow Cockpit Desk		Box/Box/File
VL4872CBDL	Left Pedestal Bow Cockpit Desk	Box/Box/File	
VL4272CRD	Right Pedestal Cockpit Desk		Box/Box/File
VL4272CLD	Left Pedestal Cockpit Desk	Box/Box/File	
VL3672RBD	Right Pedestal Bow Desk		Box/Box/File
VL3672LBD	Left Pedestal Bow Desk	Box/Box/File	
VL3672RD	Right Pedestal Desk		Box/Box/File
VL3672LD	Left Pedestal Desk	Box/Box/File	
VL3066RD	Right Pedestal Desk		Box/Box/File
VL3066LD	Left Pedestal Desk	Box/Box/File	

### Filing Options (Diagram 1)

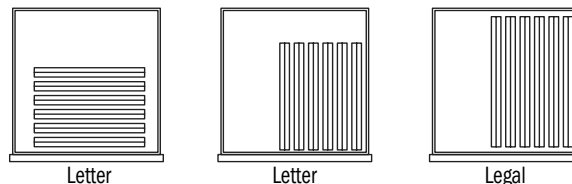


Interior Drawer Dimensions	Depth	Width	Height
Box	21"	12"	3 1/4"
File	21"	12"	9 1/8"

## MOBILE PEDESTALS

Model	Description	Drawer Configuration
		Single Pedestal Width
VL1620MP	Mobile Pedestal	Box/Box/File

### Filing Options (Diagram 2)

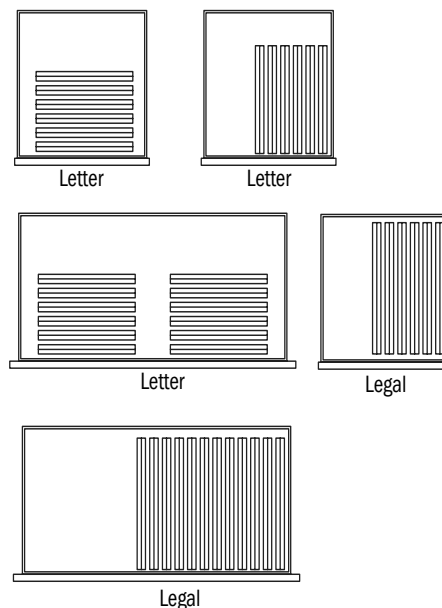


Interior Drawer Dimensions	Depth	Width	Height
Box	15"	12"	3 1/4"
File	15"	12"	9 1/8"

## EXECUTIVE RETURNS

Model	Description	Drawer Configuration (User Side)	
		Left Pedestal	Right Pedestal
VL2448MLR	Right Multi-File Return		2 Box/File/Lateral File
VL2448MLL	Left Multi-File Return	2 Box/File/Lateral File	
VL2448MRRCR	Rt. Multi-File Corner Return		2 Box/File/Lateral File
VL2448MLRCR	Lt. Multi-File Corner Return	2 Box/File/Lateral File	

### Filing Options (Diagram 3)



Interior Drawer Dimensions	Depth	Width	Height
Box	15"	12"	3 1/4"
File	15"	12"	9 1/8"
Lateral File	15"	26 5/16"	9 1/8"

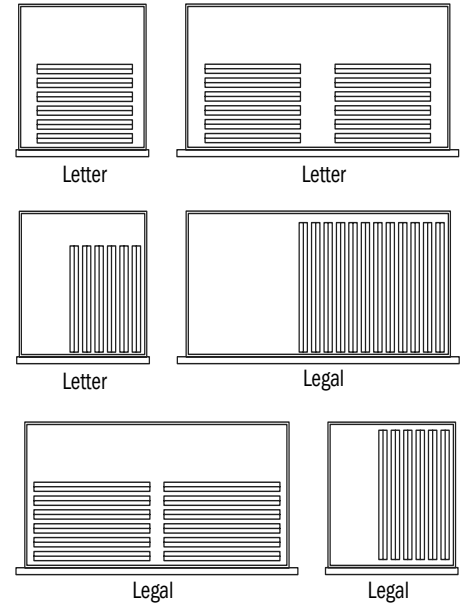
# Vision Laminate Product Information

## EXECUTIVE RETURNS

Model	Description	Drawer Configuration (User Side)	
		Left Pedestal	Right Pedestal
VL2448ERR	Right Executive Return		File/File
VL2448ELR	Left Executive Return	File/File	
VL2448ERCR	Right Corner Return		File/File
VL2448ELCR	Left Corner Return	File/File	
VL2442ERR	Right Executive Return		File/File
VL2442ELR	Left Executive Return	File/File	
VL2442ERCR	Right Corner Return		File/File
VL2442ELCR	Left Corner Return	File/File	
VL2448LRR	Right Lateral Return		Lat. File/Lat. File
VL2448LLR	Left Lateral Return	Lat. File/Lat. File	
VL2448LRCR	Right Lateral Corner Return		Lat. File/Lat. File
VL2448LLCR	Left Lateral Corner Return	Lat. File/Lat. File	

Interior Drawer Dimensions	Depth	Width	Height
Box	15"	12"	3 1/4"
File	15"	12"	9 1/8"
Lateral File	15"	32 5/16"	9 1/8"

Filing Options (Diagram 4)

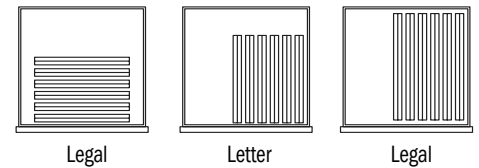


## CREDENZA

Model	Description	Drawer Configuration (User Side)	
		Left Pedestal	Right Pedestal
VL2472SC	Storage Credenza <sup>1</sup>	File/File	File/File
VL2466SC	Storage Credenza <sup>1</sup>	File/File	File/File
VL2472KC	Kneespace Credenza	File/File	File/File
VL2466KC	Kneespace Credenza	File/File	File/File
VL2460KC	Kneespace Credenza	File/File	File/File

Interior Drawer Dimensions	Depth	Width	Height
File	15"	12"	9 1/8"

Filing Options (Diagram 2)



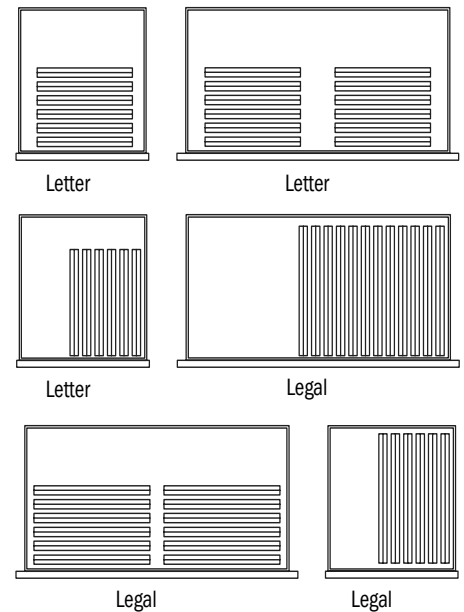
<sup>1</sup>Center Section - Hinge Door Storage

## CREDENZA

Model	Description	Drawer Configuration (User Side)	
		Left Pedestal	Right Pedestal
VL2472RC	Right Pedestal Credenza		File/File
VL2472LC	Left Pedestal Credenza	File/File	
VL2466RC	Right Pedestal Credenza		File/File
VL2466LC	Left Pedestal Credenza	File/File	
VL2460RC	Right Pedestal Credenza		File/File
VL2460LC	Left Pedestal Credenza	File/File	
VL2472LRC	Right Lateral File Credenza		Lat. File/Lat. File
VL2472LLC	Left Lateral File Credenza	Lat. File/Lat. File	

Interior Drawer Dimensions	Depth	Width	Height
File	15"	12"	9 1/8"
Lateral File	15"	32 5/16"	9 1/8"

Filing Options (Diagram 4)



# Vision Laminate Product Information

VISION - LAMINATE

## Buffet Credenza

Model	Description	Drawer Configuration
VL2472BSC	Buffet Credenza <sup>2</sup>	Along the Top <sup>2</sup> 4 Box Drawers
VL2436BSC	Buffet Credenza <sup>2</sup>	2 Box Drawers

Interior Drawer Dimensions	Depth	Width	Height
Box	15"	14 3/4"	3 1/4"

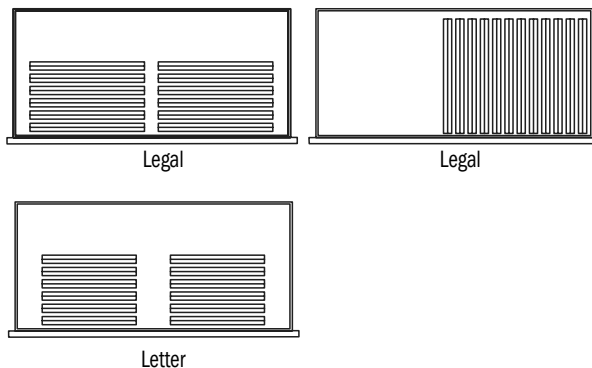
<sup>2</sup>Bottom Section - Hinge Door Storage

## LATERAL FILE CABINET

Model	Description	Drawer Configuration
VL2036-57LF	4 Drawer Lateral File Cabinet	Single Lateral Pedestal Width 4 Lateral Drawers
VL2036-42LF	3 Drawer Lateral File Cabinet	3 Lateral Drawers
VL2036-30LF	2 Drawer Lateral File Cabinet	2 Lateral Drawers
VL2436-57LF	4 Drawer Lateral File Cabinet	4 Lateral Drawers
VL2436-42LF	3 Drawer Lateral File Cabinet	3 Lateral Drawers
VL2436-30LF	2 Drawer Lateral File Cabinet	2 Lateral Drawers

Interior Drawer Dimensions	Depth	Width	Height
Lateral File	15"	32 5/16"	9 1/8"

Filing Options (Diagram 5)

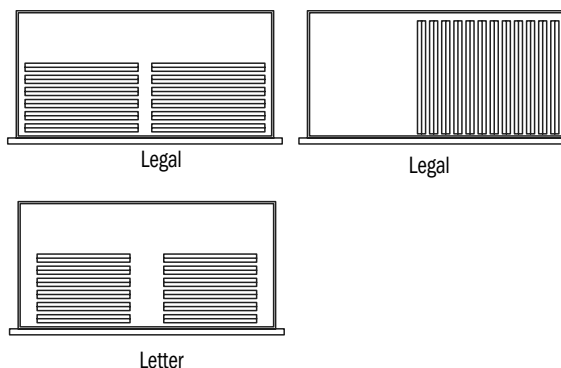


## LATERAL FILE CABINET

Model	Description	Drawer Configuration
VL2030-57LF	4 Drawer Lateral File Cabinet	Single Lateral Pedestal Width 4 Lateral Drawers
VL2030-42LF	3 Drawer Lateral File Cabinet	3 Lateral Drawers
VL2030-30LF	2 Drawer Lateral File Cabinet	2 Lateral Drawers
VL2430-57LF	4 Drawer Lateral File Cabinet	4 Lateral Drawers
VL2430-42LF	3 Drawer Lateral File Cabinet	3 Lateral Drawers
VL2430-30LF	2 Drawer Lateral File Cabinet	2 Lateral Drawers

Interior Drawer Dimensions	Depth	Width	Height
Lateral File	15"	26 5/16"	9 1/8"

Filing Options (Diagram 6)

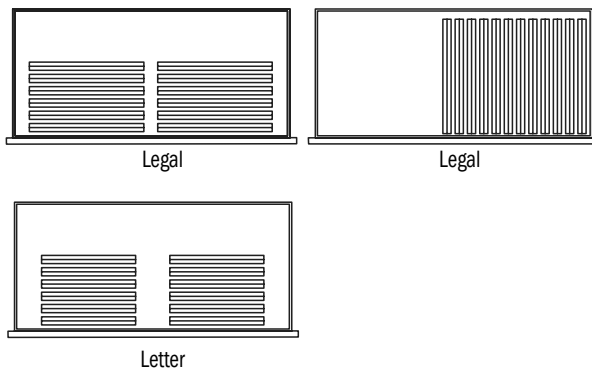


## Tall Storage Cabinets

Model	Description	Drawer Configuration
VL2436-57BFFT	Storage Cabinet	Single Lateral Pedestal Width Box/Box/Lateral File
VL2436-57FFT	Storage Cabinet	Lateral File/Lateral File

Interior Drawer Dimensions	Depth	Width	Height
Box	15"	32 5/16"	3 1/4"
Lateral File	15"	32 5/16"	9 1/8"

Filing Options (Diagram 5)



# Vision Laminate Product Information

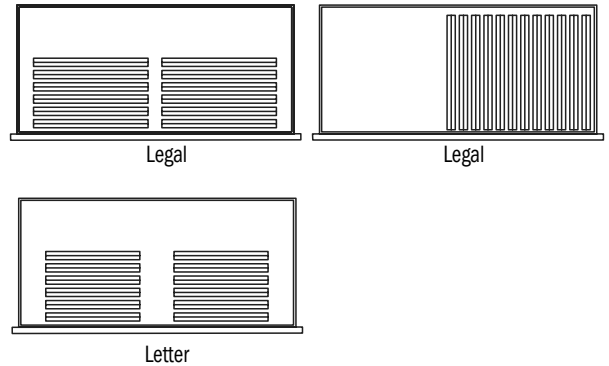
## Tall Storage Cabinets

Model	Description
VL2430-57BBFT	Storage Cabinet
VL2430-57FFT	Storage Cabinet

Drawer Configuration
Single Lateral Pedestal Width
Box/Box/Lateral File
Lateral File/Lateral File

Interior Drawer Dimensions	Depth	Width	Height
Box	15"	26 5/16"	3 1/4"
Lateral File	15"	26 5/16"	9 1/8"

Filing Options (Diagram 6)



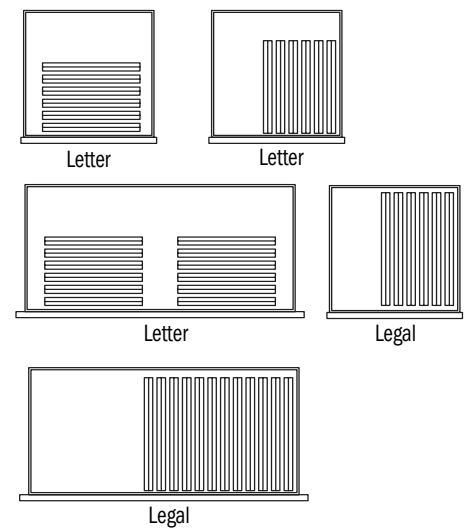
## Tall Storage Cabinets

Model	Description
VL2430-57MFR	Storage Cabinet
VL2430-57MFL	Storage Cabinet

Drawer Configuration
Single Pedestal Width
(Right) Box/Box-File/Lat. File
(Left) Box/Box-File/Lat. File

Interior Drawer Dimensions	Depth	Width	Height
Box	15"	12"	3 1/4"
File	15"	12"	9 1/8"
Lateral File	15"	26 5/16"	9 1/8"

Filing Options (Diagram 3)



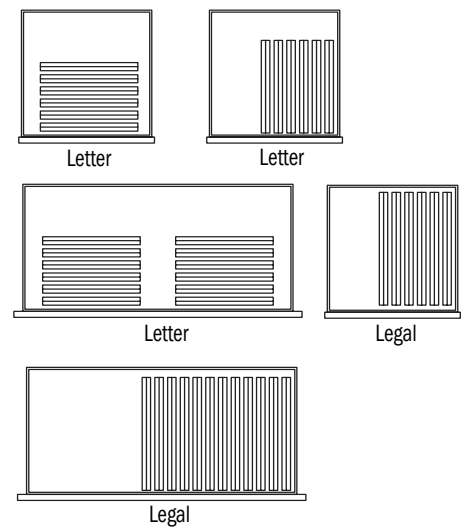
## Tall Storage Cabinets

Model	Description
VL2418-57BBFTR	Storage Cabinet
VL2418-57BBFTL	Storage Cabinet
VL2418-57FFTR	Storage Cabinet
VL2418-57FFTL	Storage Cabinet
VL2430-57WR	Wardrobe
VL2430-57WL	Wardrobe

Drawer Configuration
Single Pedestal Width
Box/Box/File
Box/Box/File
File/File
File/File
(Right) Box/Box/File
(Left) Box/Box/File

Interior Drawer Dimensions	Depth	Width	Height
Box	15"	14 5/16"	3 1/4"
File	15"	14 5/16"	9 1/8"
Lateral File	15"	26 5/16"	9 1/8"

Filing Options (Diagram 3)



# Vision Laminate Product Information

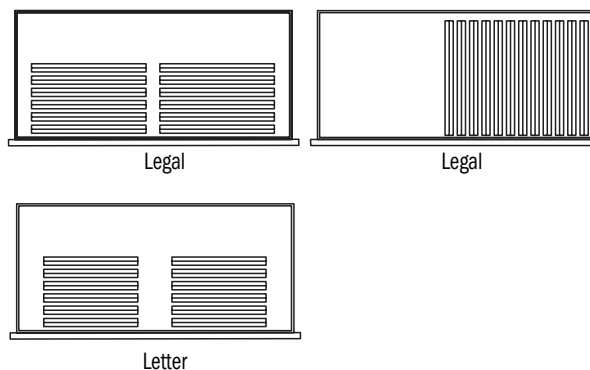
VISION - LAMINATE

## BENCH HEIGHT CABINET

Model	Description	Drawer Configuration	Single Lateral Pedestal Width
VLB2436BF	Bench Height Cabinet	Box/Lateral File	
VLB2436OF	Bench Height Cabinet	Lateral File	
VLB2436MBF	Bench Height Cabinet	Box/Lateral File	
VLB2436MOF	Bench Height Cabinet	Lateral File	
VLB1836BF	Bench Height Cabinet	Box/Lateral File	
VLB1836OF	Bench Height Cabinet	Lateral File	
VLB1836MBF	Bench Height Cabinet	Box/Lateral File	
VLB1836MOF	Bench Height Cabinet	Lateral File	

Interior Drawer Dimensions	Depth	Width	Height
Box	15"	32 5/16"	3 1/4"
Lateral File	15"	32 5/16"	9 1/8"

Filing Options (Diagram 5)

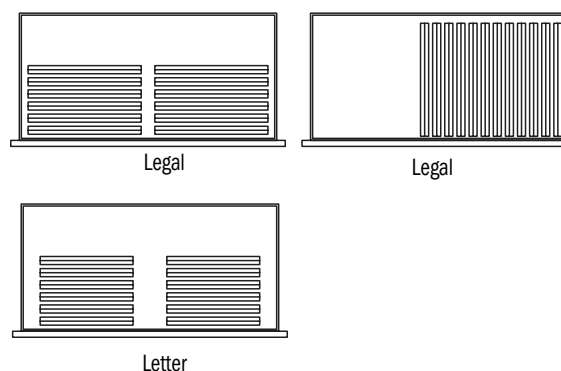


## BENCH HEIGHT CABINET

Model	Description	Drawer Configuration	Single Lateral Pedestal Width
VLB2430BF	Bench Height Cabinet	Box/Lateral File	
VLB2430OF	Bench Height Cabinet	Lateral File	
VLB2430MBF	Bench Height Cabinet	Box/Lateral File	
VLB2430MOF	Bench Height Cabinet	Lateral File	
VLB1830BF	Bench Height Cabinet	Box/Lateral File	
VLB1830OF	Bench Height Cabinet	Lateral File	
VLB1830MBF	Bench Height Cabinet	Box/Lateral File	
VLB1830MOF	Bench Height Cabinet	Lateral File	

Interior Drawer Dimensions	Depth	Width	Height
Box	15"	26 5/16"	3 1/4"
Lateral File	15"	26 5/16"	9 1/8"

Filing Options (Diagram 6)

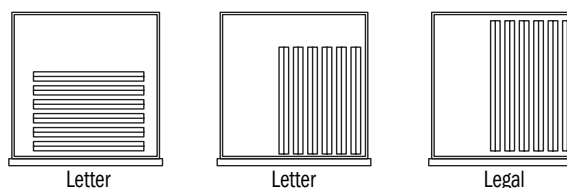


## BENCH HEIGHT CABINET

Model	Description	Drawer Configuration	Single Lateral Pedestal Width
VL2418BF	Bench Height Cabinet	Box/File	
VLB2418OF	Bench Height Cabinet	File	
VLB2418MBF	Bench Height Cabinet	Box/File	
VLB2418MOF	Bench Height Cabinet	File	
VLB1818BF	Bench Height Cabinet	Box/File	
VLB1818OF	Bench Height Cabinet	File	
VLB1818MBF	Bench Height Cabinet	Box/File	
VLB1818MOF	Bench Height Cabinet	File	

Interior Drawer Dimensions	Depth	Width	Height
Box	15"	14 5/16"	3 1/4"
Lateral File	15"	14 5/16"	9 1/8"

Filing Options (Diagram 3)



## Vision Laminate Product Information

### ADDITIONAL BENCH HEIGHT CABINET

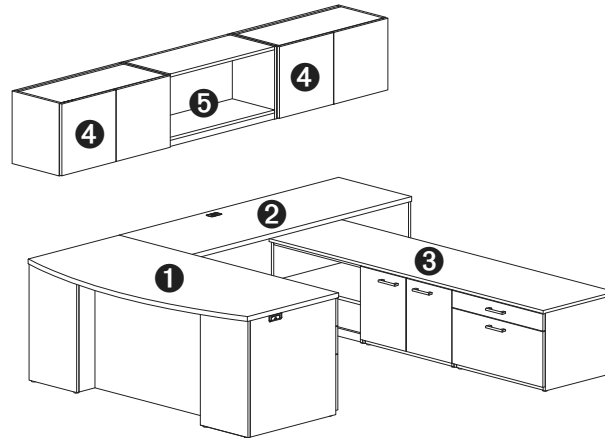
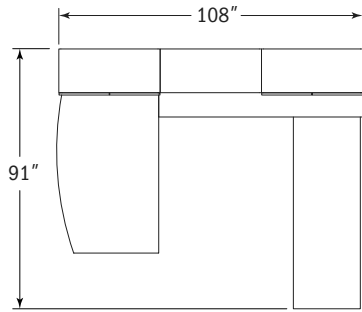
Model	Description Configuration	File Option Diagram Reference #
<b>60" w Units</b>		
VLB-30BF30BF	(right) Box/File (left) Box/File	5
VLB-300F300F	(right) File (left) File	5
VLB-30BF300S	(right) File (left) Open Compartment	5
VLB-300S30BF	(right) Open Compartment (left) File	5
<b>72" w Units</b>		
VLB-36BF36BF	(right) Box/Lateral File (left) Box/Lateral File	6
VLB-360F360F	(right) Lateral File (left) Lateral File	6
VLB-36BF360S	(right) Box/Lateral File (left) Open Compartment	6
VLB-360S36BF	(right) Open Compartment (left) Box/Lateral File	6
<b>72" w Units</b>		
VLB-360S18BF18HR	(right) Open Compartment (center) Box/File (left) Hinge Door Compartment	4
VLB-18HL18BF360S	(right) Hinge Door Compartment (center) Box/File (left) Open Compartment	4
<b>72" w Units</b>		
VLB-36BF18BF180S	(right) Box/Lateral File (center) Box/File (left) Open Compartment	4
VLB-180S18BF36BF	(right) Open Compartment (center) Box/File (left) Box/Lateral File	4
<b>72" w Units</b>		
VLB-36BF180F180S	(right) Box/Lateral File (center) File (left) Open Compartment	4
VLB-180S180F36BF	(right) Open Compartment (center) File (left) Box/Lateral File	4
<b>90" w Units</b>		
VLB-300F300F300F	(right) Lateral File (center) Lateral File (left) Lateral File	6
VLB-30BF300S30BF	(right) Box/Lateral File (center) Open Compartment (left) Box/Lateral File	3
VLB-300F300S300F	(right) Lateral File (center) Open Compartment (left) Lateral File	6
VLB-300S30HD30BF	(right) Open Compartment (center) Hinge Door Compartment (left) Lateral File	6
VLB-30BF30HD300S	(right) Box/Lateral File (center) Hinge Door Compartment (left) Open Compartment	3
VLB-30BF30SD300S	(right) Box/Lateral File (center) Sliding Door Compartment (left) Open Compartment	3
VLB-300S30SD30BF	(right) Open Compartment (center) Sliding Door Compartment (left) Box/Lateral File	3

### Modular Drawer Sizes

Model	Description	Configuration	Interior Drawer Dimensions									File Option Diagram Reference #
			Box			File			Lateral File			
			d	w	h	d	w	h	d	w	h	
VL1630MBBF	Desk Pedestal	Box/Box/File	21"	12"	3 1/4"	21"	12"	9 1/8"	n/a	n/a	n/a	1
VL1630MFF	Desk Pedestal	File/File	n/a	n/a	n/a	21"	12"	9 1/8"	n/a	n/a	n/a	1
VL1624MBBF	Credenza Pedestal	Box/Box/File	15"	12"	3 1/4"	15"	12"	9 1/8"	n/a	n/a	n/a	2
VL3024MFF	Credenza Pedestal	File/File	n/a	n/a	n/a	15"	12"	9 1/8"	n/a	n/a	n/a	5
VL3624MLF	Lateral File - 36" Wide	Lat. File/Lat. File	n/a	n/a	n/a	n/a	n/a	n/a	15"	32 5/16"	9 1/8"	7
VL3024MLF	Lateral File - 30" Wide	Lat. File/Lat. File	n/a	n/a	n/a	n/a	n/a	n/a	15"	26 5/16"	9 1/8"	8
VL3624MBSC	Buffet Credenza	2 Top Box Drawers	15"	14 3/4"	3 1/4"	n/a	n/a	n/a	n/a	n/a	n/a	n/a

## Vision Laminate - Typical

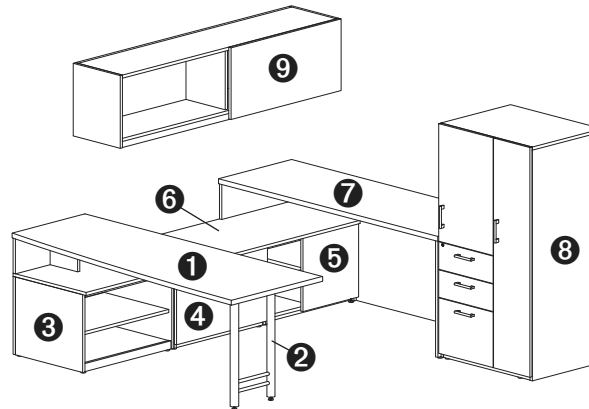
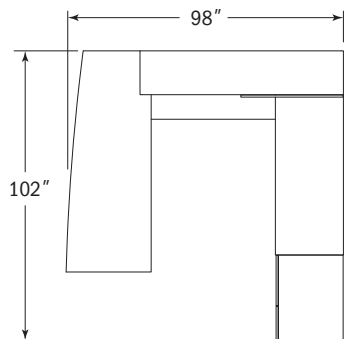
### VL001



Model	Description	Qty	Price
1 VL3672LBD	bow front single pedestal desk with break front modesty, left	1	\$1,844
2 VL2472RSHR	shell return, right	1	\$832
3 VLB-300S30HD30BF	90" bench height configuration	1	\$1,838
4 VL1636WSO	wall mount overhead with two doors	2	\$1,386
5 VL1536WOO	wall mount open overhead	1	\$549
<b>Typical List Price</b>			<b>\$6,449</b>

\*\* Typical priced with TFL laminate worksurface option.

### VL002

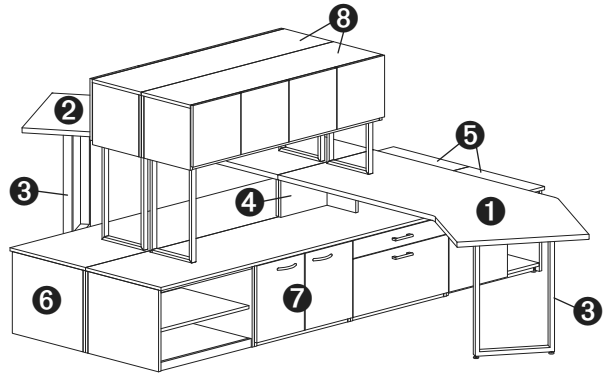
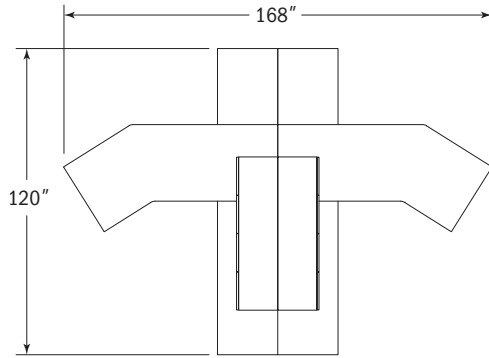


Model	Description	Qty	Price
1 VLB3078FINL	bench height supported fin peninsula desk, left	1	\$1,277
2 18HS	H base	1	\$333
3 VLB2430MOS	open shelf bench height modular pedestal	1	\$450
4 VLB2430MBF	box/file bench height modular pedestal	1	\$639
5 VLB2430MSD	sliding door bench height modular pedestal	1	\$697
6 VLB2490MT	bench height modular top	1	\$273
7 VLB2472SHBR	bench height supported shell credenza, right	1	\$951
8 VL2430-57WR	57"h box/box/file storage wardrobe, right	1	\$1,905
9 VL1672WSD	wall mount overhead with sliding door	1	\$1,403
<b>Typical List Price</b>			<b>\$7,928</b>

\*\* Typical priced with TFL laminate worksurface option.

## Vision Laminate - Typical

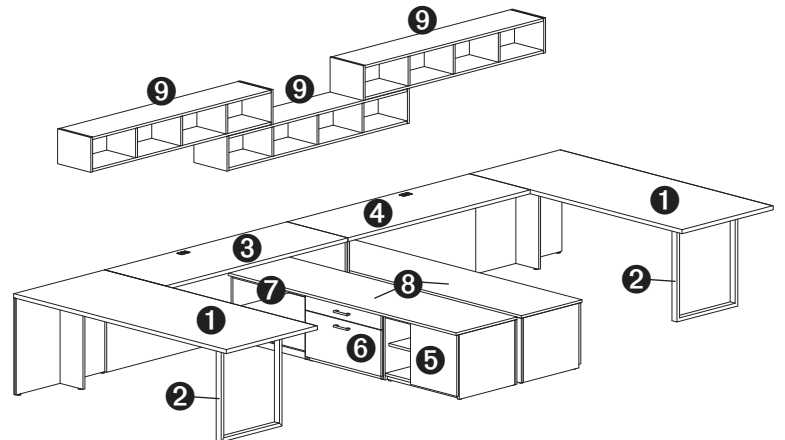
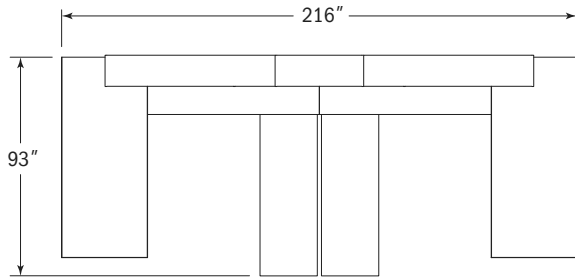
### VL003



Model	Description	Qty	Price
1	VL3084MBMTR	modular boomerang desk top, right	1 \$1,476
2	VL3084MBMTL	modular boomerang desk top, left	1 \$1,476
3	18US	U base modular desk top	2 \$666
4	VLB1030TSP	bench height "T" support	2 \$512
5	VLB2430SD	bench height cabinet with sliding door	2 \$1,562
6	VLB-30BF30HD30OS	90" bench height configuration	1 \$1,838
7	VLB-30OS30HD30BF	90" bench height configuration	1 \$1,838
8	VL1660PSHD-2737	split height post support overhead cabinet with four doors	2 \$2,754
<b>Typical List Price</b>			<b>\$12,122</b>

\*\* Typical priced with TFL laminate worksurface option.

### VL004



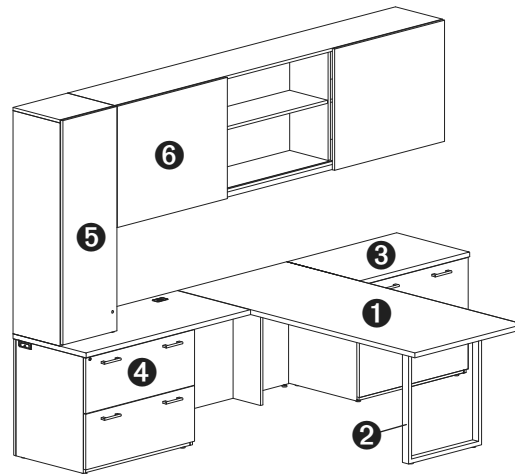
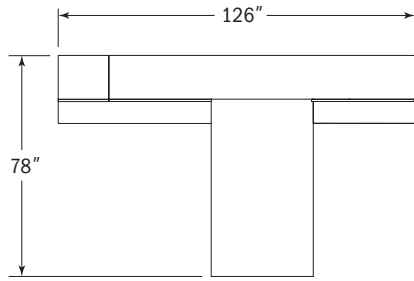
Model	Description	Qty	Price
1	VL3684RCT	rectangle peninsula desk	2 \$2,276
2	24US	U base for peninsula desk	2 \$708
3	VLB2472LSHR	bench height supported shell return, left	1 \$832
4	VLB2472RSR	bench height supported shell return, right	1 \$832
5	VLB2430MSD	sliding door bench height modular pedestal	2 \$1,394
6	VLB2430MBF	box/file bench height modular pedestal	2 \$1,278
7	VLB2430MOS	open shelf bench height modular pedestal	2 \$900
8	VLB2490MT	90" bench height modular top	2 \$546
9	VL1072WCU	72" wall mount cubby	3 \$2,085
<b>Typical List Price</b>			<b>\$10,851</b>

\*\* Typical priced with TFL laminate worksurface option.



## Vision Laminate - Typical

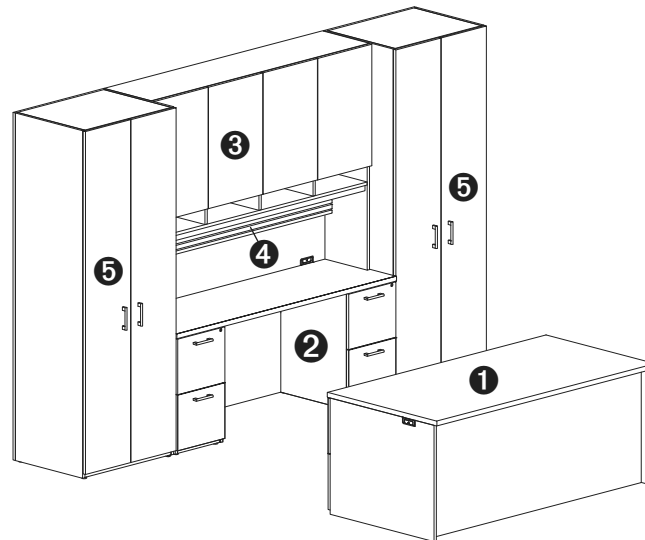
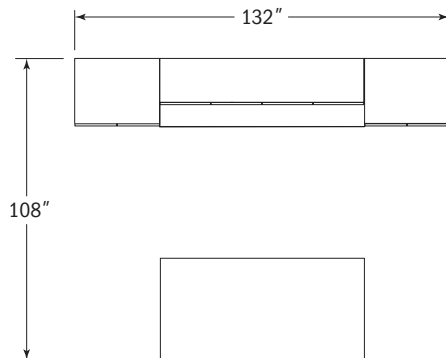
### VL005



Model	Description	Qty	Price
1 VL3678RCT	rectangle peninsula desk	1	\$1,080
2 24US	U base for peninsula desk	1	\$354
3 VL2436-30LF	lateral file	1	\$1,008
4 VL2454LLR	lateral file return, left	1	\$1,401
5 VL1618DSTD	double height storage tower, left	1	\$844
6 VL16108WDSD	double height wall mount overhead cabinet w/two sliding doors	1	\$2,282
<b>Typical List Price</b>			<b>\$6,969</b>

\*\* Typical priced with TFL laminate worksurface option.

### VL006

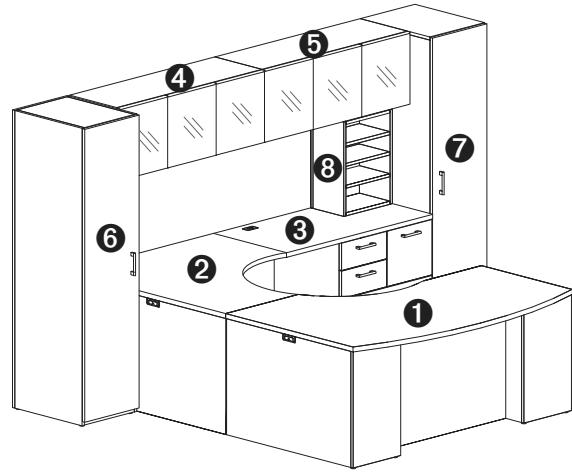
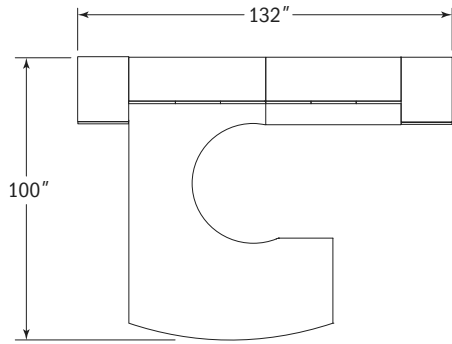


Model	Description	Qty	Price
1 VL3672DDF	double pedestal desk with recessed modesty panel	1	\$1,667
2 VL2472KC	kneespace credenza	1	\$1,687
3 VL1672DSOC	double height storage overhead cabinet with four doors and cubbies	1	\$1,926
4 VS72AR	accessory rail	1	\$282
5 VL2430-84W	84" wardrobe	2	\$4,228
<b>Typical List Price</b>			<b>\$9,790</b>

\*\* Typical priced with TFL laminate worksurface option.

## Vision Laminate - Typical

### VL007



Model	Description	Qty	Price
1 VL4872CDDL	bow front cockpit single pedestal desk with break front modesty, left	1	\$2,131
2 VL4852ERCU	cockpit corner unit, right	1	\$1,575
3 VL2448MRCR	multi-file corner return, right	1	\$1,417
4 VL1648WGSOL	wall mount overhead with three frosted glass doors w/aluminum frame, left	1	\$1,547
5 VL1648WGSOR	wall mount overhead with three frosted glass doors w/aluminum frame, right	1	\$1,547
6 VL2418-72WL	72" h wardrobe, left	1	\$1,277
7 VL2418-72WR	72" h wardrobe, right	1	\$1,277
8 VL2016ST	storage tower insert/transaction support	1	\$607

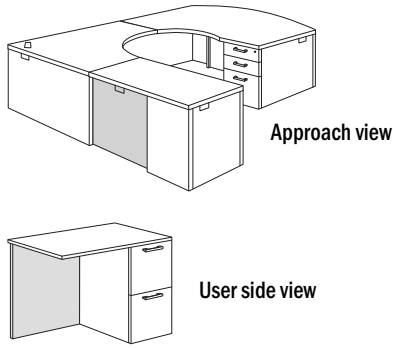
**Typical List Price**

**\$11,378**

\*\* Typical priced with TFL laminate worksurface option.

## Modular Modesty Panel Applications

### Returns with Breakfront

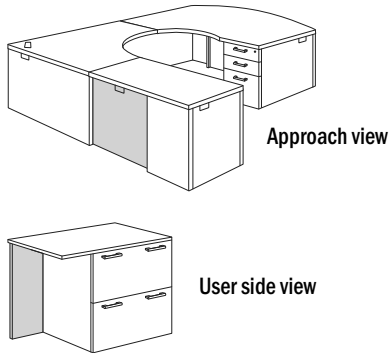


Modesty Panel Sizes for Returns with Pedestal

Top Width	Pedestal Width	Modesty Width	Modesty Height	Model Number
36	15 <sup>5</sup> / <sub>8</sub>	21 <sup>3</sup> / <sub>16</sub>	28	VL2821MA
42	15 <sup>5</sup> / <sub>8</sub>	27 <sup>3</sup> / <sub>16</sub>	28	VL2827MA
48	15 <sup>5</sup> / <sub>8</sub>	33 <sup>3</sup> / <sub>16</sub>	28	VL2833MA
54	15 <sup>5</sup> / <sub>8</sub>	39 <sup>3</sup> / <sub>16</sub>	28	VL2839MA
60	15 <sup>5</sup> / <sub>8</sub>	45 <sup>3</sup> / <sub>16</sub>	28	VL2845MA

Consists of:  
 VL2442MCT - top  
 VL1624MFF - pedestal  
 VL2827MA - breakfront modesty panel

### Returns with Breakfront



Modesty Panel Sizes for Returns with Lateral File Pedestal

Top Width	Pedestal 36" Wide	Modesty Width	Modesty Height	Model Number
42	35 <sup>7</sup> / <sub>8</sub>	6 <sup>15</sup> / <sub>16</sub>	28	VL2807MA
48	35 <sup>7</sup> / <sub>8</sub>	12 <sup>15</sup> / <sub>16</sub>	28	VL2812MA
54	35 <sup>7</sup> / <sub>8</sub>	18 <sup>15</sup> / <sub>16</sub>	28	VL2818MA
60	35 <sup>7</sup> / <sub>8</sub>	24 <sup>15</sup> / <sub>16</sub>	28	VL2824MA

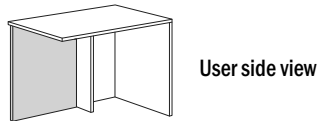
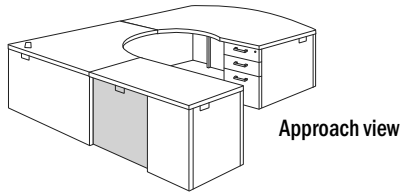
Consists of:  
 VL2448MCT - top  
 VL3624MLF - pedestal  
 VL2812MA - modesty panel

Top Width	Pedestal 30" Wide	Modesty Width	Modesty Height	Model Number
36	29 <sup>7</sup> / <sub>8</sub>	6 <sup>15</sup> / <sub>16</sub>	28	VL2807MA
42	29 <sup>7</sup> / <sub>8</sub>	12 <sup>15</sup> / <sub>16</sub>	28	VL2812MA
48	29 <sup>7</sup> / <sub>8</sub>	18 <sup>15</sup> / <sub>16</sub>	28	VL2818MA
54	29 <sup>7</sup> / <sub>8</sub>	24 <sup>15</sup> / <sub>16</sub>	28	VL2824MA
60	29 <sup>7</sup> / <sub>8</sub>	30 <sup>15</sup> / <sub>16</sub>	28	VL2831MA

VISION - LAMINATE

## Modular Modesty Panel Applications

### Return Shells with Breakfront

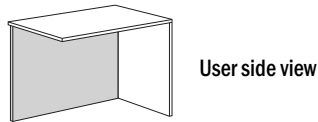
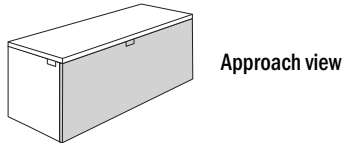


Consists of:  
 VL2442MCT - top  
 VL1624WEAR - wing end panel  
 VL2827MA - breakfront modesty panel

Modesty Panel Sizes for Return Shells using VL1624WEAL or VL1624WEAR wing end panel

Top Width	Wing Assembly Width	Modesty Width	Modesty Height	Model Number
36	15 <sup>5</sup> / <sub>8</sub>	21 <sup>3</sup> / <sub>16</sub>	28	VL2821MA
42	15 <sup>5</sup> / <sub>8</sub>	27 <sup>3</sup> / <sub>16</sub>	28	VL2827MA
48	15 <sup>5</sup> / <sub>8</sub>	33 <sup>3</sup> / <sub>16</sub>	28	VL2833MA
54	15 <sup>5</sup> / <sub>8</sub>	39 <sup>3</sup> / <sub>16</sub>	28	VL2839MA
60	15 <sup>5</sup> / <sub>8</sub>	45 <sup>3</sup> / <sub>16</sub>	28	VL2845MA

### Return Shells



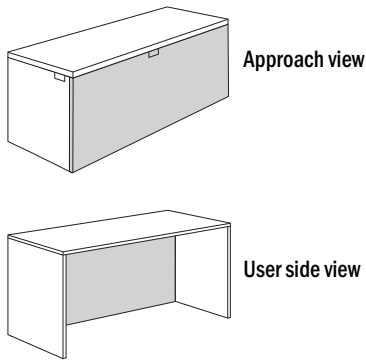
Consists of:  
 VL2442MCT - top  
 VL24EP - end panel  
 VL2843MA - modesty panel

Modesty Panel Sizes for Return Shells using VL24EP end panel

Top Width	End Panel Thickness VL24EP	Modesty Width	Modesty Height	Model Number
36	<sup>3</sup> / <sub>4</sub>	36 <sup>1</sup> / <sub>16</sub>	28	VL2837MA
42	<sup>3</sup> / <sub>4</sub>	42 <sup>1</sup> / <sub>16</sub>	28	VL2843MA
48	<sup>3</sup> / <sub>4</sub>	48 <sup>1</sup> / <sub>16</sub>	28	VL2849MA
54	<sup>3</sup> / <sub>4</sub>	54 <sup>1</sup> / <sub>16</sub>	28	VL2855MA

## Modular Modesty Panel Applications

### Desk Shells

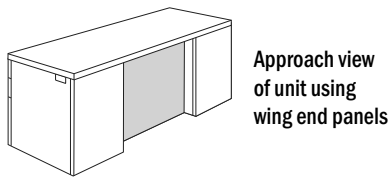


Consists of:  
 VL2442MCT - top  
 VL23EP - (2) end panels  
 VL2842MA - modesty panel

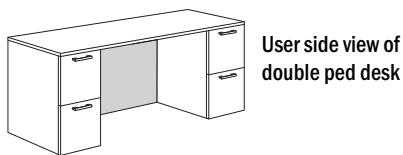
Modesty Panel Sizes for Desk Shells with both left and right ends using VL23EP end panel

Top Width	End Panel Thickness VL23EP	Modesty Width	Modesty Height	Model Number
30	3/4	29 7/8	28	VL2830MA
36	3/4	35 7/8	28	VL2836MA
42	3/4	41 7/8	28	VL2842MA
48	3/4	47 7/8	28	VL2848MA
54	3/4	53 7/8	28	VL2854MA
60	3/4	59 7/8	28	VL2860MA

### Desk Shells with Breakfront



Consists of:  
 VL1630WEAL - left wing end panel  
 VL1630WEAR - right wing end panel  
 VL2840MA - breakfront modesty panel  
 VL3072MCT - top



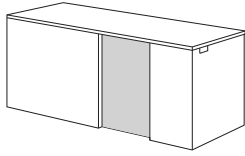
Consists of:  
 VL1630MFF - (2) 30" deep modular pedestals  
 VL2840MA - breakfront modesty panel  
 VL3072MCT - top

Modular Breakfront Modesty Panel Sizes for double pedestal desks and credenzas -OR- Single pedestal desks and credenzas with the VL1630WEAL or VL1630WEAR wing end assembly or with the VL1624WEAL or VL1624WEAR wing end assembly

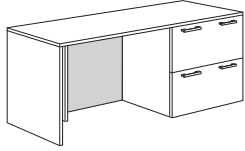
Top Width	Right or Left Pedestal or Wing End Assembly Width	Modesty Width	Modesty Height	Model Number
60	15 5/8	28 5/8	28	VL2828MA
66	15 5/8	34 5/8	28	VL2834MA
72	15 5/8	40 5/8	28	VL2840MA
78	15 5/8	46 5/8	28	VL2847MA
84	15 5/8	52 5/8	28	VL2853MA
90	15 5/8	58 5/8	28	VL2859MA

## Modular Modesty Panel Applications

### Credenza Shells with Breakfront



Approach view



User side view

**Consists of:**

VL3624MLF - pedestal

VL1624WEAL - wing end support ▲

VL2820MA - breakfront modesty panel ▲

VL2472MCT - top

Modular Breakfront Modesty Panel Sizes for Single Pedestal Credenzas with 30" or 36" wide pedestal -OR- using the VL1624WEAL OR VL1624WEAR wing end assembly.

Top Width	36" Pedestal Width	Wing End Assembly Width	Modesty Width	Modesty Height	Model Number
66	35 <sup>7</sup> / <sub>8</sub>	15 <sup>5</sup> / <sub>8</sub>	14 <sup>3</sup> / <sub>8</sub>	28	VL2814MA
72	35 <sup>7</sup> / <sub>8</sub>	15 <sup>5</sup> / <sub>8</sub>	20 <sup>3</sup> / <sub>8</sub>	28	VL2820MA
78	35 <sup>7</sup> / <sub>8</sub>	15 <sup>5</sup> / <sub>8</sub>	26 <sup>3</sup> / <sub>8</sub>	28	VL2826MA
84	35 <sup>7</sup> / <sub>8</sub>	15 <sup>5</sup> / <sub>8</sub>	32 <sup>3</sup> / <sub>8</sub>	28	VL2832MA
90	35 <sup>7</sup> / <sub>8</sub>	15 <sup>5</sup> / <sub>8</sub>	38 <sup>3</sup> / <sub>8</sub>	28	VL2838MA
96	35 <sup>7</sup> / <sub>8</sub>	15 <sup>5</sup> / <sub>8</sub>	44 <sup>3</sup> / <sub>8</sub>	28	VL2844MA

Top Width	30" Pedestal Width	Wing End Assembly Width	Modesty Width	Modesty Height	Model Number
60	29 <sup>7</sup> / <sub>8</sub>	15 <sup>5</sup> / <sub>8</sub>	14 <sup>3</sup> / <sub>8</sub>	28	VL2814MA
66	29 <sup>7</sup> / <sub>8</sub>	15 <sup>5</sup> / <sub>8</sub>	20 <sup>3</sup> / <sub>8</sub>	28	VL2820MA
72	29 <sup>7</sup> / <sub>8</sub>	15 <sup>5</sup> / <sub>8</sub>	26 <sup>3</sup> / <sub>8</sub>	28	VL2826MA
78	29 <sup>7</sup> / <sub>8</sub>	15 <sup>5</sup> / <sub>8</sub>	32 <sup>3</sup> / <sub>8</sub>	28	VL2832MA
84	29 <sup>7</sup> / <sub>8</sub>	15 <sup>5</sup> / <sub>8</sub>	38 <sup>3</sup> / <sub>8</sub>	28	VL2838MA
90	29 <sup>7</sup> / <sub>8</sub>	15 <sup>5</sup> / <sub>8</sub>	44 <sup>3</sup> / <sub>8</sub>	28	VL2844MA
96	29 <sup>7</sup> / <sub>8</sub>	15 <sup>5</sup> / <sub>8</sub>	50 <sup>3</sup> / <sub>8</sub>	28	VL2850MA

Description	D	W	H	CTN WT	CU FT	① Model	TFL List Price	HPL List Price
Bow Front Double Pedestal Desk with Break Front Modesty	42	72	30	435	61	VL4272BD	\$2,583	\$2,719
	36	84	30	435	61	VL3684BD	\$2,575	\$2,711
	36	72	30	392	53	VL3672BD	\$2,105	\$2,215



- top edge profile on user and approach sides
- two end panel grommets with wire pass thru
- letter width pedestals
- pedestal front locking
- 6" overhang on approach side
- VL4272BD chassis - 36" x 72"
- VL3684BD chassis - 30" x 84"
- VL3672BD chassis - 30" x 72"
- VL4272BD & VL3672BD kneespace - 40 5/8"
- VL3684BD kneespace - 52 5/8"
- optional 14" half modesty panel available in place of full modesty, specify half modesty and indicate color on order
- trim modesty panel, see page 65

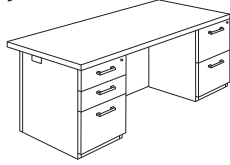
Bow Front Double Pedestal Desk with Recessed Modesty	42	72	30	435	61	VL4272BDF	\$2,505	\$2,640
	36	84	30	435	61	VL3684BDF	\$2,496	\$2,632
	36	72	30	392	53	VL3672BDF	\$2,026	\$2,136



- top edge profile on user and approach sides
- two end panel grommets with wire pass thru
- letter width pedestals
- pedestal front locking
- full width modesty panel
- 6" overhang on approach side
- VL4272BDF chassis - 36" x 72"
- VL3684BDF chassis - 30" x 84"
- VL3672BDF chassis - 30" x 72"
- VL4272BDF & VL3672BDF kneespace - 40 5/8"
- VL3684BDF kneespace - 52 5/8"

Description	D	W	H	CTN WT	CU FT	① Model	TFL List Price	HPL List Price
Double Pedestal Desk with Break Front Modesty	36	84	30	420	61	VL3684DD	\$2,420	\$2,547
	36	78	30	400	57	VL3678DD	\$2,405	\$2,531
	36	72	30	392	53	VL3672DD	\$1,746	\$1,837

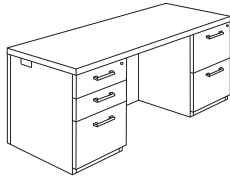
**NOW!**



- top edge profile on user and approach sides
- two end panel grommets with wire pass thru
- letter width pedestals
- pedestal front locking
- 6" overhang on approach side
- VL3684DD chassis - 30" x 84"
- VL3678DD chassis - 30" x 78"
- VL3672DD chassis - 30" x 72"
- VL3684DD kneespace - 52 5/8"
- VL3678DD kneespace - 46 5/8"
- VL3672DD kneespace - 40 5/8"
- optional 14" half modesty panel available in place of full modesty, specify half modesty and indicate color on order
- trim modesty panel, see page 65

Double Pedestal with Break Front Modesty	30	72	30	368	44	VL3072DD	\$1,725	\$1,815
	30	66	30	289	41	VL3066DD	\$1,700	\$1,790
	30	60	30	289	37	VL3060DD	\$1,619	\$1,704

**NOW!**



- top edge profile on user and approach sides
- two end panel grommets with wire pass thru
- letter width pedestals
- pedestal front locking
- VL3072DD kneespace - 40 5/8"
- VL3066DD kneespace - 34 5/8"
- VL3060DD kneespace - 28 5/8"
- optional 14" half modesty panel available in place of full modesty, specify half modesty and indicate color on order
- trim modesty panel, see page 65

**To Order, Specify:**

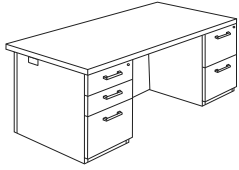
- ① Model Number
- ▲ ② Worksurface Material (see page 38)
  - a.) TFL
  - b.) HPL
- ③ Laminate Color (see page 38)
  - a.) Worksurface Color
  - b.) Chassis Color
  - c.) Drawer Color
- ④ Edge Profile (see page 43)
- ⑤ Pull Style and Color (see page 43)
- ⑥ Grommet Color - Matte Black (MBK) or Stardust Silver (STS) (see page 44)
- ⑦ Other Product Options (see page 39)
- ⑧ Accessories (see page 407)
- ⑨ Power and Data Options (see page 407)

When ordering Quickship products, place a "Q" in front of model number.  
Example: QVL3072DD

**NOW!**  
*Need it.*  
JSI Quickship



Description	D	W	H	CTN WT	CU FT	① Model	TFL List Price	HPL List Price
<b>Double Pedestal Desk with Recessed Modesty</b> 	36	84	30	420	61	VL3684DDF	\$2,341	\$2,468
	36	78	30	400	57	VL3678DDF	\$2,326	\$2,452
	36	72	30	392	53	VL3672DDF	\$1,667	\$1,758

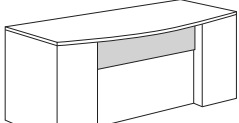


- top edge profile on user and approach sides
- two end panel grommets with wire pass thru
- letter width pedestals
- pedestal front locking
- full width modesty panel
- 3 3/4" overhang on approach side
- VL3684DDF chassis - 32 1/4" x 84"
- VL3678DDF chassis - 32 1/4" x 78"
- VL3672DDF chassis - 32 1/4" x 72"
- VL3684DDF kneespace - 52 5/8"
- VL3678DDF kneespace - 46 5/8"
- VL3672DDF kneespace - 40 5/8"

<b>Double Pedestal Desk with Recessed Modesty</b> 	30	72	30	368	44	VL3072DDF	\$1,646	\$1,736
	30	66	30	289	41	VL3066DDF	\$1,622	\$1,711
	30	60	30	289	37	VL3060DDF	\$1,540	\$1,625



- top edge profile on user and approach sides
- two end panel grommets with wire pass thru
- letter width pedestals
- pedestal front locking
- full width modesty panel
- 3 3/4" overhang on approach side
- VL3072DDF chassis - 26 1/4" x 72"
- VL3066DDF chassis - 26 1/4" x 66"
- VL3060DDF chassis - 26 1/4" x 60"
- VL3072DDF kneespace - 40 5/8"
- VL3066DDF kneespace - 34 5/8"
- VL3060DDF kneespace - 28 5/8"

Description	D	W	H	CTN WT	CU FT	① Model	List Price
Trim Modesty Panel	1/4	52	10	6	2	VS1052FMP	\$500
	1/4	46	10	5	2	VS1046FMP	\$478
	1/4	40	10	5	2	VS1040FMP	\$458
	1/4	34	10	4	1	VS1034FMP	\$438
	1/4	28	10	4	1	VS1028FMP	\$388

**NOW!**

- mounts in front of existing modesty panel on desk and credenza or alone in open kneespace area
- acrylic panel - frosted
- field installed
- VS1052FMP use with 84" desk
- VS1046FMP use with 78" desk
- VS1040FMP use with 72" desk
- VS1034FMP use with 66" desk
- VS1028FMP use with 60" desk

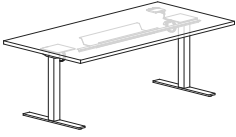
VISION - LAMINATE

**To Order, Specify:**

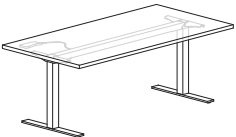
- ① Model Number
- ▲ ② Worksurface Material (see page 38)
  - a.) TFL
  - b.) HPL
- ③ Laminate Color (see page 38)
  - a.) Worksurface Color
  - b.) Chassis Color
  - c.) Drawer Color
- ④ Edge Profile (see page 43)
- ⑤ Pull Style and Color (see page 43)
- ⑥ Grommet Color - Matte Black (MBK) or Stardust Silver (STS) (see page 44)
- ⑦ Other Product Options (see page 39)
- ⑧ Accessories (see page 407)
- ⑨ Power and Data Options (see page 407)

When ordering Quickship products, place a "Q" in front of model number.  
Example: QVL3072DD

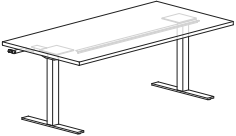


Description	D	W	H	CTN WT	CU FT	Model	TFL List Price	HPL List Price
<b>Electric Adjustable Height Table Desk</b> 	36	72	Adj.	194	18	VL3672AHTD-EL	\$2,987	\$3,212
	30	72	Adj.	175	16	VL3072AHTD-EL	\$2,976	\$3,165
	30	66	Adj.	168	15	VL3066AHTD-EL	\$2,942	\$3,114
	30	60	Adj.	160	14	VL3060AHTD-EL	\$2,902	\$3,059
	24	72	Adj.	151	12	VL2472AHTD-EL	\$2,864	\$3,015
	24	66	Adj.	146	11	VL2466AHTD-EL	\$2,865	\$3,002
	24	60	Adj.	140	10	VL2460AHTD-EL	\$2,852	\$2,978

- 27 1/2" to 44 1/2" height adjustment
- top edge profile on user and approach sides
- push button control pad mounted right or left
- key pad features height display with four memory settings
- 72" power cord
- 225 lb. max load
- specify Black Sandtex (BSX) or Stardust Silver (STS) base finish
- ships KD

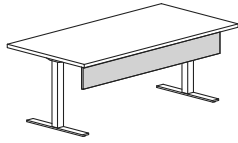
<b>Pneumatic Adjustable Height Table Desk</b> 	36	72	Adj.	194	18	VL3672AHTD-PN	\$2,965	\$3,191
	30	72	Adj.	175	16	VL3072AHTD-PN	\$2,936	\$3,125
	30	66	Adj.	168	15	VL3066AHTD-PN	\$2,886	\$3,059
	30	60	Adj.	160	14	VL3060AHTD-PN	\$2,831	\$2,989
	24	72	Adj.	151	12	VL2472AHTD-PN	\$2,843	\$2,993
	24	66	Adj.	146	11	VL2466AHTD-PN	\$2,828	\$2,966
	24	60	Adj.	140	10	VL2460AHTD-PN	\$2,801	\$2,926

- 27 1/2" to 44 1/2" height adjustment
- top edge profile on user and approach sides
- release lever mounts under edge of top
- 225 lb. max load
- specify Matte Black or Alloy base finish
- ships KD

<b>Crank Adjustable Height Table Desk</b> 	36	72	Adj.	194	18	VL3672AHTD-CR	\$1,977	\$2,202
	30	72	Adj.	175	16	VL3072AHTD-CR	\$1,962	\$2,151
	30	66	Adj.	168	15	VL3066AHTD-CR	\$1,922	\$2,094
	30	60	Adj.	160	14	VL3060AHTD-CR	\$1,877	\$2,033
	24	72	Adj.	151	12	VL2472AHTD-CR	\$1,834	\$1,984
	24	66	Adj.	146	11	VL2466AHTD-CR	\$1,833	\$1,971
	24	60	Adj.	140	10	VL2460AHTD-CR	\$1,818	\$1,944

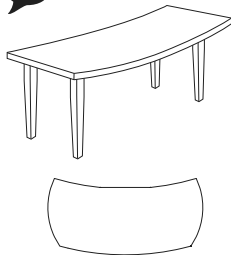
- 27 1/2" to 44 1/2" height adjustment
- top edge profile on user and approach sides
- retractable handle
- 225 lb. max load
- specify Black Sandtex (BSX) or Stardust Silver (STS) base finish
- ships KD

Description	D	W	H	CTN WT	CU FT	① Model	List Price
Modesty Panel for Adjustable Height Tables	3/4	64	9	18	3	VL0964TDM	\$328
	3/4	58	9	16	2	VL0958TDM	\$318
	3/4	52	9	14	2	VL0952TDM	\$308



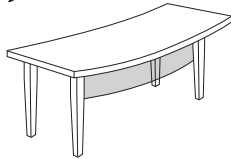
- VL0964TDM use with 72" wide adjustable height desk
- VL0958TDM use with 66" wide adjustable height desk
- VL0952TDM use with 60" wide adjustable height desk
- flat edge detail
- modesty panel bracket is available in Black Sandtex (BSX) or Stardust Silver (STS)

Table Desk	D	W	H	CTN WT	CU FT	Model	TFL List Price	HPL List Price
	36	72	30	176	35	VL3672TD	\$1,715	\$1,804
<b>NOW!</b>	30	66	30	168	41	VL3066TD	\$1,595	\$1,678



- top edge profile on user and approach sides
- trim modesty panel available; see below
- includes matching finish wood legs
- not available with Bridal Blanco, Dove Grey, Slate Grey or Taupe laminate

Trim Modesty Panel	D	W	H	CTN WT	CU FT	Model	List Price
	1/4	56	10	8	2	VS1072FMP	\$515
<b>NOW!</b>	1/4	54	10	8	2	VS1066FMP	\$506



- VS1072FMP used with 72" table desk
- VS1066FMP used with 66" table desk
- acrylic panel - frosted
- field installed

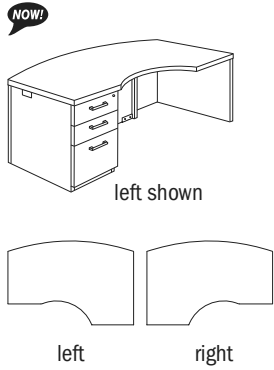
**To Order, Specify:**

- ① Model Number
- ▲ ② Worksurface Material (see page 38)
  - a.) TFL
  - b.) HPL
- ③ Laminate Color (see page 38)
- ④ Edge Profile (see page 43)
- ⑤ Metal Color (see page 47)
- ⑥ Other Product Options (see page 39)

When ordering Quickship products, place a "Q" in front of model number.  
Example: QVL3072DD

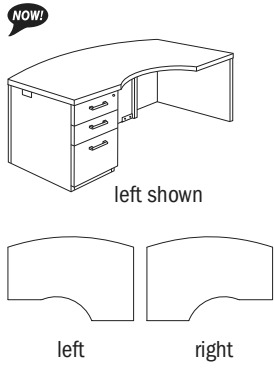


Description	D	W	H	CTN WT	CU FT	① Model	TFL List Price	HPL List Price
<b>Bow Front Cockpit Single Pedestal Desk with Break Front Modesty</b>	48	72	30	312	66	VL4872CBDR	\$2,131	\$2,242
	48	72	30	312	66	VL4872CDDL	\$2,131	\$2,242

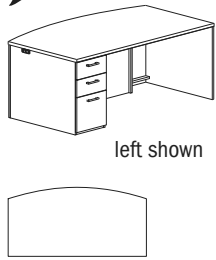


- cockpit style wrap around top
- top edge profile on user and approach sides
- two end panel grommets
- letter width pedestal
- pedestal front locking
- 6" overhang on approach side
- chassis - 42" x 72"
- optional 14" half modesty panel available in place of full modesty, specify half modesty and indicate color on order
- trim modesty panel, see page 71

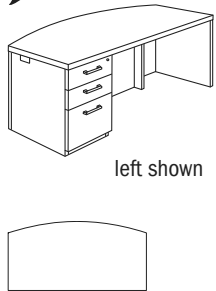
<b>Bow Front Cockpit Single Pedestal Desk with Recessed Modesty</b>	48	72	30	312	66	VL4872CBDRF	\$2,052	\$2,163
	48	72	30	312	66	VL4872CBDLF	\$2,052	\$2,163



- cockpit style wrap around top
- top edge profile on user and approach sides
- two end panel grommets
- letter width pedestal
- pedestal front locking
- full width modesty panel
- 6" overhang on approach side
- chassis - 42" x 72"

Description	D	W	H	CTN WT	CU FT	① Model	TFL List Price	HPL List Price
<b>Bow Front Single Pedestal Desk with Break Front Modesty</b>	42	72	30	365	61	VL4272RBD	\$2,261	\$2,380
	42	72	30	365	61	VL4272LBD	\$2,261	\$2,380
 left shown	36	84	30	365	61	VL3684RBD	\$2,148	\$2,260
	36	84	30	365	61	VL3684LBD	\$2,148	\$2,260
	36	72	30	351	53	VL3672RBD	\$1,844	\$1,941
	36	72	30	351	53	VL3672LBD	\$1,844	\$1,941

- top edge profile on user and approach sides
- two end panel grommets with wire pass thru
- letter width pedestals
- pedestal front locking
- 6" overhang on approach side
- VL4272RBD & VL4272LBD chassis - 36" x 72"
- VL3684RBD & VL3684LBD chassis - 30" x 84"
- VL3672RBD & VL3672LBD chassis - 30" x 72"
- optional 14" half modesty panel available in place of full modesty, specify half modesty and indicate color on order
- trim modesty panel, see page 71

<b>Bow Front Single Pedestal Desk with Recessed Modesty</b>	42	72	30	365	61	VL4272RBDF	\$2,182	\$2,301
	42	72	30	365	61	VL4272LBDF	\$2,182	\$2,301
 left shown	36	84	30	365	61	VL3684RBDF	\$2,069	\$2,181
	36	84	30	365	61	VL3684LBDF	\$2,069	\$2,181
	36	72	30	351	53	VL3672RBDF	\$1,766	\$1,862
	36	72	30	351	53	VL3672LBDF	\$1,766	\$1,862

- top edge profile on user and approach sides
- two end panel grommets with wire pass thru
- letter width pedestals
- pedestal front locking
- full width modesty panel
- 6" overhang on approach side
- VL4272RBDF & VL4272LBDF chassis - 36" x 72"
- VL3684RBDF & VL3684LBDF chassis - 30" x 84"
- VL3672RBDF & VL3672LBDF chassis - 30" x 72"

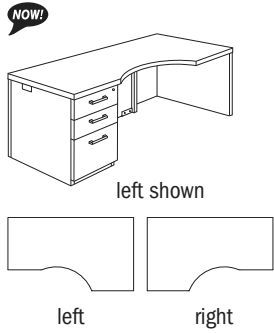
**To Order, Specify:**

- ① Model Number
- ▲ ② Worksurface Material (see page 38)
  - a.) TFL
  - b.) HPL
- ③ Laminate Color (see page 38)
  - a.) Worksurface Color
  - b.) Chassis Color
  - c.) Drawer Color
- ④ Edge Profile (see page 43)
- ⑤ Pull Style and Color (see page 43)
- ⑥ Grommet Color - Matte Black (MBK) or Stardust Silver (STS) (see page 44)
- ⑦ Other Product Options (see page 39)
- ⑧ Accessories (see page 407)
- ⑨ Power and Data Options (see page 407)

When ordering Quickship products, place a "Q" in front of model number.  
Example: QVL3072DD

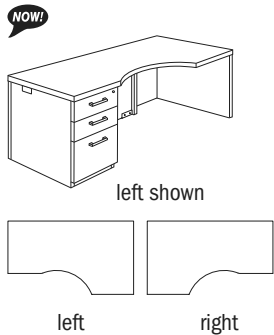


Description	D	W	H	CTN WT	CU FT	① Model	TFL List Price	HPL List Price
<b>Cockpit Single Pedestal Desk with Break Front Modesty</b>	42	72	30	308	61	VL4272CRD	\$2,037	\$2,145
	42	72	30	308	61	VL4272CLD	\$2,037	\$2,145



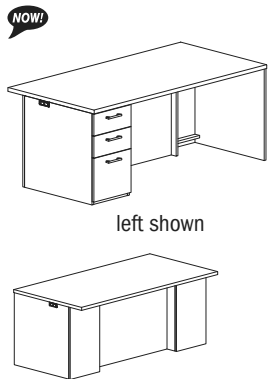
- cockpit style wrap around top
- top edge profile on user and approach sides
- two end panel grommets with wire pass thru
- letter width pedestal
- pedestal front locking
- optional 14" half modesty panel available in place of full modesty, specify half modesty and indicate color on order
- trim modesty panel, see page 71

<b>Cockpit Single Pedestal Desk with Recessed Modesty</b>	42	72	30	308	63	VL4272CRDF	\$1,959	\$2,066
	42	72	30	308	63	VL4272CLDF	\$1,959	\$2,066



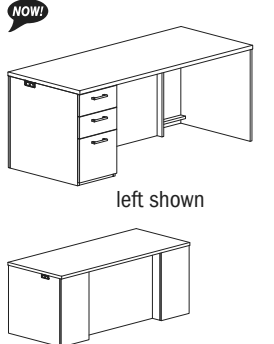
- cockpit style wrap around top
- top edge profile on user and approach sides
- two end panel grommets with wire pass thru
- letter width pedestal
- pedestal front locking
- full width modesty panel

<b>36" d Pedestal Desk with Break Front Modesty</b>	36	84	30	325	61	VL3684RD	\$2,032	\$2,138
	36	84	30	325	61	VL3684LD	\$2,032	\$2,138



- |    |    |    |     |    |          |         |         |
|----|----|----|-----|----|----------|---------|---------|
| 36 | 72 | 30 | 302 | 53 | VL3672RD | \$1,474 | \$1,550 |
| 36 | 72 | 30 | 302 | 53 | VL3672LD | \$1,474 | \$1,550 |
- top edge profile on user and approach sides
  - two end panel grommets with wire pass thru
  - letter width pedestal
  - pedestal front locking
  - 6" overhang on approach side
  - VL3684RD or VL3684LD chassis - 30" x 84"
  - VL3672RD or VL3672LD chassis - 30" x 72"
  - optional 14" half modesty panel available in place of full modesty, specify half modesty and indicate color on order
  - trim modesty panel, see page 71

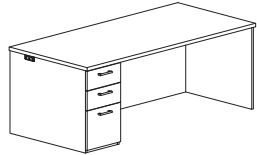
<b>30" d Pedestal Desk with Break Front Modesty</b>	30	72	30	290	44	VL3072RD	\$1,453	\$1,528
	30	72	30	290	44	VL3072LD	\$1,453	\$1,528



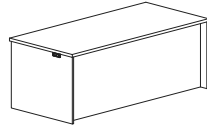
- |    |    |    |     |    |          |         |         |
|----|----|----|-----|----|----------|---------|---------|
| 30 | 66 | 30 | 262 | 41 | VL3066RD | \$1,394 | \$1,466 |
| 30 | 66 | 30 | 262 | 41 | VL3066LD | \$1,394 | \$1,466 |
- top edge profile on user and approach sides
  - two end panel grommets with wire pass thru
  - letter width pedestal
  - pedestal front locking
  - optional 14" half modesty panel available in place of full modesty, specify half modesty and indicate color on order
  - trim modesty panel, see page 71

Description	D	W	H	CTN WT	CU FT	① Model	TFL List Price	HPL List Price
36" d Pedestal Desk with Recessed Modesty	36	84	30	325	61	VL3684RDF	\$1,953	\$2,060
	36	84	30	325	61	VL3684LDF	\$1,953	\$2,060
	36	72	30	302	53	VL3672RDF	\$1,395	\$1,472
	36	72	30	302	53	VL3672LDF	\$1,395	\$1,472

**NOW!**



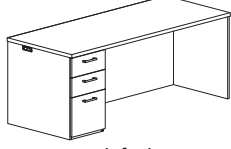
left shown



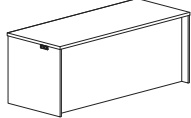
- top edge profile on user and approach sides
- two end panel grommets with wire pass thru
- letter width pedestal
- pedestal front locking
- full width modesty panel

30" d Pedestal Desk with Recessed Modesty	30	72	30	290	44	VL3072RDF	\$1,374	\$1,449
	30	72	30	290	44	VL3072LDF	\$1,374	\$1,449
	30	66	30	262	41	VL3066RDF	\$1,315	\$1,388
	30	66	30	262	41	VL3066LDF	\$1,315	\$1,388

**NOW!**



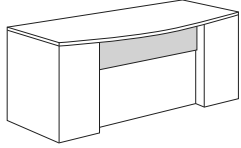
left shown



- top edge profile on user and approach sides
- two end panel grommets with wire pass thru
- letter width pedestal
- pedestal front locking
- full width modesty panel

							List Price
Trim Modesty Panel	1/4	52	10	6	2	VS1052FMP	\$500
	1/4	40	10	5	2	VS1040FMP	\$458
	1/4	34	10	4	1	VS1034FMP	\$438

**NOW!**



- mounts in front of existing modesty panel
- acrylic panel - frosted
- field installed
- VS1052FMP use with 84" single pedestal desk
- VS1040FMP use with 72" single pedestal desk
- VS1034FMP use with 66" single pedestal desk


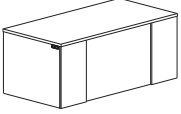
**To Order, Specify:**

- ① Model Number
- ▲ ② Worksurface Material (see page 38)
  - a.) TFL
  - b.) HPL
- ③ Laminate Color (see page 38)
  - a.) Worksurface Color
  - b.) Chassis Color
  - c.) Drawer Color
- ④ Edge Profile (see page 43)
- ⑤ Pull Style and Color (see page 43)
- ⑥ Grommet Color - Matte Black (MBK) or Stardust Silver (STS) (see page 44)
- ⑦ Other Product Options (see page 39)
- ⑧ Accessories (see page 407)
- ⑨ Power and Data Options (see page 407)

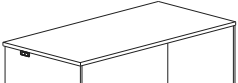

When ordering Quickship products, place a "Q" in front of model number.  
Example: QVL3072DD

**NOW!**  
Need it.  
JSI Quickship


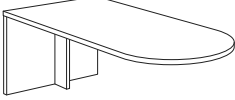



Description	D	W	H	CTN WT	CU FT	① Model	TFL List Price	HPL List Price
<b>Shell Desk with Break Front Modesty</b>  	36	72	30	205	53	<b>VL3672SHD</b>	<b>\$1,354</b>	<b>\$1,424</b>
	30	72	30	192	44	<b>VL3072SHD</b>	<b>\$1,276</b>	<b>\$1,342</b>
	30	66	30	179	41	<b>VL3066SHD</b>	<b>\$1,203</b>	<b>\$1,266</b>
	30	60	30	168	41	<b>VL3060SHD</b>	<b>\$1,170</b>	<b>\$1,231</b>

- top edge profile on user and approach sides
- two end panel grommets
- optional 14" half modesty panel available in place of full modesty, specify half modesty and indicate color on order
- trim modesty panel; see page 71
- shell units are not designed to accept modular pedestals from pages 97 and 98 ▲

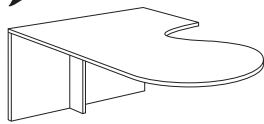
<b>Shell Desk with Recessed Modesty</b>  	36	72	30	205	53	<b>VL3672SHDF</b>	<b>\$1,275</b>	<b>\$1,346</b>
	30	72	30	192	44	<b>VL3072SHDF</b>	<b>\$1,197</b>	<b>\$1,264</b>
	30	66	30	179	41	<b>VL3066SHDF</b>	<b>\$1,124</b>	<b>\$1,187</b>
	30	60	30	168	41	<b>VL3060SHDF</b>	<b>\$1,091</b>	<b>\$1,152</b>

- top edge profile on user and approach sides
- two end panel grommets
- full width modesty panel
- shell units are not designed to accept modular pedestals from pages 97 and 98 ▲

Description	D	W	H	CTN WT	CU FT	① Model	TFL List Price	HPL List Price
<b>Bullet Peninsula Desk</b>	36	84	30	175	61	VL3684B	\$1,502	\$1,581
	36	78	30	169	57	VL3678B	\$1,462	\$1,539
	36	72	30	163	53	VL3672B	\$1,244	\$1,309
	30	84	30	168	51	VL3084B	\$1,406	\$1,480
	30	78	30	163	48	VL3078B	\$1,362	\$1,434
	30	72	30	158	44	VL3072B	\$1,197	\$1,260
	30	66	30	152	41	VL3066B	\$1,097	\$1,153

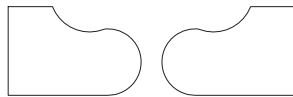
- top edge profile on three open sides
- one end panel grommet
- non-handed
- not recommended for freestanding use
- trim modesty panel, see page 75
- bases must be purchased separately; see page 75 for options

<b>Cockpit Bullet Peninsula Desk</b>	48	72	30	175	66	VL4872CBR	\$1,482	\$1,560
	48	72	30	175	66	VL4872CBL	\$1,482	\$1,560



left shown

- cockpit style wrap around top
- edge profile on three open sides
- one end panel grommet
- not recommended for freestanding use
- trim modesty panel, see page 75
- bases must be purchased separately; see page 75 for options



left

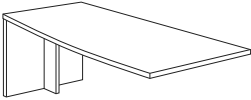
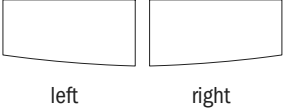
right

**To Order, Specify:**

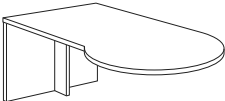
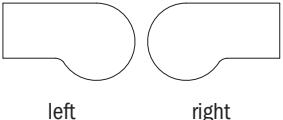
- ① Model Number
- ② Worksurface Material (see page 38)
  - a.) TFL
  - b.) HPL
- ③ Laminate Color (see page 38)
  - a.) Worksurface Color
  - b.) Chassis Color
- ④ Edge Profile (see page 43)
- ⑤ Grommet Color - Matte Black (MBK) or Stardust Silver (STS) (see page 44)
- ⑥ Other Product Options (see page 39)
- ⑦ Accessories (see page 407)
- ⑧ Power and Data Options (see page 407)

When ordering Quickship products, place a "Q" in front of model number.  
Example: QVL3072DD

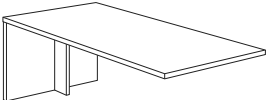



Description	D	W	H	CTN WT	CU FT	① Model	TFL List Price	HPL List Price
<b>Fin Peninsula Desk</b>  left shown  left      right	36	84	30	176	61	VL3684FINR	\$1,493	\$1,570
	36	84	30	176	61	VL3684FINL	\$1,493	\$1,570
	36	78	30	170	57	VL3678FINR	\$1,452	\$1,527
	36	78	30	170	57	VL3678FINL	\$1,452	\$1,527
	36	72	30	164	53	VL3672FINR	\$1,315	\$1,383
	36	72	30	164	53	VL3672FINL	\$1,315	\$1,383
	30	84	30	169	51	VL3084FINR	\$1,404	\$1,478
	30	84	30	169	51	VL3084FINL	\$1,404	\$1,478
	30	78	30	164	48	VL3078FINR	\$1,355	\$1,425
	30	78	30	164	48	VL3078FINL	\$1,355	\$1,425
	30	72	30	159	44	VL3072FINR	\$1,228	\$1,292
	30	72	30	159	44	VL3072FINL	\$1,228	\$1,292

- 30" deep at end panel for 36" deep top
- 24" deep at end panel for 30" deep top
- arch on approach side
- edge profile on three open sides
- one end panel grommet
- not recommended for freestanding use
- trim modesty panel, see page 75
- bases must be purchased separately; see page 75 for options

<b>P-Top Peninsula Desk</b>  left shown  left      right	42	84	30	190	71	VL4284RP	\$1,584	\$1,667
	42	84	30	190	71	VL4284LP	\$1,584	\$1,667
	42	78	30	184	66	VL4278RP	\$1,529	\$1,609
	42	78	30	184	66	VL4278LP	\$1,529	\$1,609
	42	72	30	175	61	VL4272RP	\$1,439	\$1,515
	42	72	30	175	61	VL4272LP	\$1,439	\$1,515

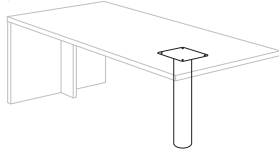
- 42" at widest point
- 30" at end panel
- edge profile on three open sides
- one end panel grommet
- not recommended for freestanding use
- trim modesty panel, see page 75
- bases must be purchased separately; see page 75 for options

<b>Rectangle Peninsula Desk</b>  	36	84	30	176	61	VL3684RCT	\$1,138	\$1,196
	36	78	30	170	57	VL3678RCT	\$1,080	\$1,137
	36	72	30	164	53	VL3672RCT	\$1,032	\$1,086
	30	84	30	169	51	VL3084RCT	\$1,081	\$1,138
	30	78	30	164	48	VL3078RCT	\$1,044	\$1,099
	30	72	30	159	44	VL3072RCT	\$1,016	\$1,068

- edge profile on three open sides
- one end panel grommet
- non-handed
- not recommended for freestanding use
- trim modesty panel, see page 75
- bases must be purchased separately; see page 75 for options

Bases for Peninsula Tops

**NOW!**

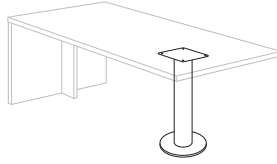


Column Base

- 04BB - Black Sandtex - \$321
- 04SB - Stardust Silver - \$321

Base:

- 13 gauge steel
- 4" diameter

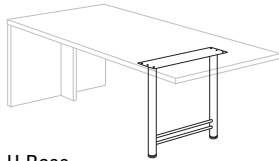


Column Disk Base

- 12DB - Black Sandtex - \$385
- 12DS - Stardust Silver - \$385

Base:

- support disk: 11" diameter

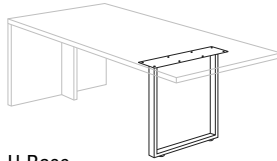


H Base

- use with 36" or 48" deep tops
- 24HB - Black Sandtex - \$354
- 24HS - Stardust Silver - \$354

use with 30" deep tops

- 18HB - Black Sandtex - \$333
- 18HS - Stardust Silver - \$333



U Base

- use with 36" or 48" deep tops
- 24UB - Black Sandtex - \$354
- 24US - Stardust Silver - \$354

use with 30" deep tops

- 18UB - Black Sandtex - \$333
- 18US - Stardust Silver - \$333



▲ Rectangular Base

use with 36" deep tops

- 36FSQB - Black Sandtex - \$473
- 36FSQS - Stardust Silver - \$473

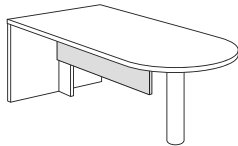
use with 30" deep tops

- 30FSQB - Black Sandtex - \$457
- 30FSQS - Stardust Silver - \$457

\*\* should not be used with fin shaped tops

Description	D	W	H	CTN WT	CU FT	① Model	List Price
Trim Modesty Panel for Peninsula Tops	1/4	52	10	6	2	VS1052FMP	\$500
	1/4	46	10	5	2	VS1046FMP	\$478
	1/4	40	10	5	2	VS1040FMP	\$458
	1/4	34	10	4	1	VS1034FMP	\$438

**NOW!**



- mounts in open kneespace area
- acrylic panel - frosted
- field installed
- VS1052FMP use with 84" bullet, fin, P-top or rectangle peninsula desk
- VS1046FMP use with 78" bullet, fin, P-top or rectangle peninsula desk
- VS1040FMP use with 72" bullet, fin, P-top or rectangle peninsula desk
- VS1034FMP use with 66" bullet, fin, P-top or rectangle peninsula desk

To Order, Specify:

- ① Model Number
- ▲ ② Worksurface Material (see page 38)
  - a.) TFL
  - b.) HPL
- ③ Laminate Color (see page 38)
- ④ Edge Profile (see page 43)
- ⑤ Other Product Options (see page 39)
- ⑥ Accessories (see page 407)
- ⑦ Power and Data Options (see page 407)


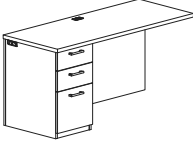
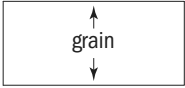
When ordering Quickship products, place a "Q" in front of model number.  
Example: QVL3072DD

**NOW!**  
Need it.  
JSI Quickship

Description	D	W	H	CTN WT	CU FT	① Model	TFL List Price	HPL List Price
File/File Return	24	60	30	190	30	VL2460ERR	\$1,287	\$1,354
 24	60	30	190	30	VL2460ELR	\$1,287	\$1,354	
	24	54	30	179	27	VL2454ERR	\$1,184	\$1,246
left shown	24	54	30	179	27	VL2454ELR	\$1,184	\$1,246
	24	48	30	168	25	VL2448ERR	\$987	\$1,039
	24	48	30	168	25	VL2448ELR	\$987	\$1,039
	24	42	30	155	22	VL2442ERR	\$926	\$974
	24	42	30	155	22	VL2442ELR	\$926	\$974
	20	60	30	173	26	VL2060ERR	\$1,236	\$1,300
	20	60	30	173	26	VL2060ELR	\$1,236	\$1,300
	20	54	30	163	23	VL2054ERR	\$1,138	\$1,197
	20	54	30	163	23	VL2054ELR	\$1,138	\$1,197
	20	48	30	154	21	VL2048ERR	\$949	\$998
	20	48	30	154	21	VL2048ELR	\$949	\$998
	20	42	30	142	18	VL2042ERR	\$889	\$935
	20	42	30	142	18	VL2042ELR	\$889	\$935

- top edge profile on user side
- short grain direction
- one end and back panel grommet with wire pass thru
- one surface grommet
- letter width file/file pedestal
- pedestal front locking
- optional 10" modesty panel available in place of full modesty, specify 10" modesty and indicate color on order

VISION - LAMINATE

Description	D	W	H	CTN WT	CU FT	① Model	TFL List Price	HPL List Price
Box/Box/File Return	24	60	30	190	30	VL2460ERY	\$1,287	\$1,354
	24	60	30	190	30	VL2460ELY	\$1,287	\$1,354
	24	54	30	179	27	VL2454ERY	\$1,184	\$1,246
left shown	24	54	30	179	27	VL2454ELY	\$1,184	\$1,246
	24	48	30	168	25	VL2448ERY	\$987	\$1,039
	24	48	30	168	25	VL2448ELY	\$987	\$1,039
	24	42	30	155	22	VL2442ERY	\$926	\$974
	24	42	30	155	22	VL2442ELY	\$926	\$974
	20	60	30	173	26	VL2060ERY	\$1,236	\$1,300
	20	60	30	173	26	VL2060ELY	\$1,236	\$1,300
	20	54	30	163	23	VL2054ERY	\$1,138	\$1,197
	20	54	30	163	23	VL2054ELY	\$1,138	\$1,197
	20	48	30	154	21	VL2048ERY	\$949	\$998
	20	48	30	154	21	VL2048ELY	\$949	\$998
	20	42	30	142	18	VL2042ERY	\$889	\$935
	20	42	30	142	18	VL2042ELY	\$889	\$935


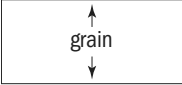
- top edge profile on user side
- short grain direction
- one end and back panel grommet with wire pass thru
- one surface grommet
- letter width box/box/file pedestal
- pedestal front locking
- optional 10" modesty panel available in place of full modesty, specify 10" modesty and indicate color on order

### To Order, Specify:


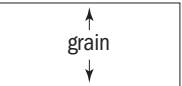
- ① Model Number
- ▲ ② Worksurface Material (see page 38)
  - a.) TFL
  - b.) HPL
- ③ Laminate Color (see page 38)
  - a.) Worksurface Color
  - b.) Chassis Color
  - c.) Drawer Color
- ④ Edge Profile (see page 43)
- ⑤ Pull Style and Color (see page 43)
- ⑥ Grommet Color - Matte Black (MBK) or Stardust Silver (STS) (see page 44)
- ⑦ Other Product Options (see page 39)
- ⑧ Accessories (see page 407)
- ⑨ Power and Data Options (see page 407)

When ordering Quickship products, place a "Q" in front of model number.  
Example: QVL3072DD

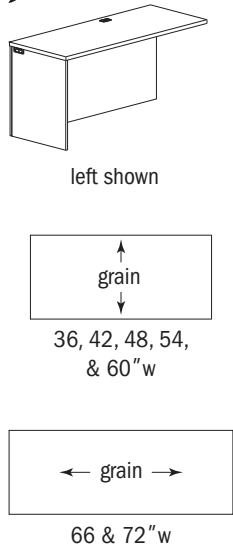


Description	D	W	H	CTN WT	CU FT	① Model	TFL List Price	HPL List Price
<b>Lateral File Return</b>  left shown 	24	60	30	199	30	VL2460LRR	\$1,599	\$1,683
	24	60	30	199	30	VL2460LLR	\$1,599	\$1,683
	24	54	30	187	27	VL2454LRR	\$1,401	\$1,475
	24	54	30	187	27	VL2454LLR	\$1,401	\$1,475
	24	48	30	175	25	VL2448LRR	\$1,340	\$1,411
	24	48	30	175	25	VL2448LLR	\$1,340	\$1,411
	20	60	30	188	26	VL2060LRR	\$1,536	\$1,615
	20	60	30	188	26	VL2060LLR	\$1,536	\$1,615
	20	54	30	177	23	VL2054LRR	\$1,346	\$1,416
	20	54	30	177	23	VL2054LLR	\$1,346	\$1,416
	20	48	30	164	21	VL2048LRR	\$1,288	\$1,355
	20	48	30	164	21	VL2048LLR	\$1,288	\$1,355

- top edge profile on user side
- short grain direction
- one end and back panel grommet with wire pass thru
- one surface grommet
- 36" width lateral file
- pedestal front locking
- optional 10" modesty panel available in place of full modesty, specify 10" modesty and indicate color on order

<b>Multi-File Return</b>  left shown 	24	60	30	202	30	VL2460MLR	\$1,716	\$1,806
	24	60	30	202	30	VL2460MLL	\$1,716	\$1,806
	24	54	30	190	27	VL2454MLR	\$1,614	\$1,698
	24	54	30	190	27	VL2454MLL	\$1,614	\$1,698
	24	48	30	179	25	VL2448MLR	\$1,417	\$1,491
	24	48	30	179	25	VL2448MLL	\$1,417	\$1,491
	20	60	30	191	26	VL2060MLR	\$1,649	\$1,735
	20	60	30	191	26	VL2060MLL	\$1,649	\$1,735
	20	54	30	180	23	VL2054MLR	\$1,551	\$1,632
	20	54	30	180	23	VL2054MLL	\$1,551	\$1,632
	20	48	30	167	21	VL2048MLR	\$1,360	\$1,432
	20	48	30	167	21	VL2048MLL	\$1,360	\$1,432

- top edge profile on user side
- short grain direction
- one end and back panel grommet with wire pass thru
- one surface grommet
- 30" width multi-file
- pedestal front locking
- optional 10" modesty panel available in place of full modesty, specify 10" modesty and indicate color on order

Description	D	W	H	CTN WT	CU FT	① Model	TFL List Price	HPL List Price
Shell Return	24	72	30	153	36	VL2472RSHR	\$832	\$875
<b>NOW!</b>	24	72	30	153	36	VL2472LSHR	\$832	\$875
 <p>left shown</p> <p>↑ grain ↓ 36, 42, 48, 54, &amp; 60" w</p> <p>← grain → 66 &amp; 72" w</p>	24	66	30	147	33	VL2466RSHR	\$774	\$814
	24	66	30	147	33	VL2466LSHR	\$774	\$814
	24	60	30	141	30	VL2460RSHR	\$752	\$791
	24	60	30	141	30	VL2460LSHR	\$752	\$791
	24	54	30	136	27	VL2454RSHR	\$730	\$768
	24	54	30	136	27	VL2454LSHR	\$730	\$768
	24	48	30	130	25	VL2448RSHR	\$709	\$746
	24	48	30	130	25	VL2448LSHR	\$709	\$746
	24	42	30	124	22	VL2442RSHR	\$687	\$723
	24	42	30	124	22	VL2442LSHR	\$687	\$723
	24	36	30	120	19	VL2436RSHR	\$667	\$702
	24	36	30	120	19	VL2436LSHR	\$667	\$702
	20	72	30	142	31	VL2072RSHR	\$800	\$842
	20	72	30	142	31	VL2072LSHR	\$800	\$842
	20	66	30	138	28	VL2066RSHR	\$744	\$783
	20	66	30	138	28	VL2066LSHR	\$744	\$783
	20	60	30	135	26	VL2060RSHR	\$723	\$761
	20	60	30	135	26	VL2060LSHR	\$723	\$761
	20	54	30	129	23	VL2054RSHR	\$700	\$737
	20	54	30	129	23	VL2054LSHR	\$700	\$737
20	48	30	125	21	VL2048RSHR	\$681	\$717	
20	48	30	125	21	VL2048LSHR	\$681	\$717	
20	42	30	119	18	VL2042RSHR	\$660	\$695	
20	42	30	119	18	VL2042LSHR	\$660	\$695	
20	36	30	115	16	VL2036RSHR	\$641	\$675	
20	36	30	115	16	VL2036LSHR	\$641	\$675	

- top edge profile on user side
- short grain direction for 36", 42", 48", 54", and 60" wide
- long grain direction for 66" and 72" wide
- one end and back panel grommet
- one surface grommet
- shell units are not designed to accept modular pedestals from pages 97 and 98 ▲
- optional 10" modesty panel available in place of full modesty, specify 10" modesty on order ▲

**To Order, Specify:**

- ① Model Number
- ▲ ② Worksurface Material (see page 38)
  - a.) TFL
  - b.) HPL
- ③ Laminate Color (see page 38)
  - a.) Worksurface Color
  - b.) Chassis Color
  - c.) Drawer Color
- ④ Edge Profile (see page 43)
- ⑤ Pull Style and Color (see page 43)
- ⑥ Grommet Color - Matte Black (MBK) or Stardust Silver (STS) (see page 44)
- ⑦ Other Product Options (see page 39)
- ⑧ Accessories (see page 407)
- ⑨ Power and Data Options (see page 407)

When ordering Quickship products, place a "Q" in front of model number.  
Example: QVL3072DD





Description	D	W	H	CTN WT	CU FT	① Model	TFL List Price	HPL List Price
Cockpit Shell Return	24	66	30	153	36	VL2466RCSHR	\$978	\$1,028
Cockpit Shell Return	24	66	30	153	36	VL2466LCSHR	\$978	\$1,028
Cockpit Shell Return	24	60	30	147	33	VL2460RCSHR	\$919	\$968
Cockpit Shell Return	24	60	30	147	33	VL2460LCSHR	\$919	\$968
Cockpit Shell Return	24	54	30	147	33	VL2454RCSHR	\$887	\$933
Cockpit Shell Return	24	54	30	147	33	VL2454LCSHR	\$887	\$933

left shown

left right

grain

54" & 60" w

grain

66" w

- top edge profile on user side
- long grain direction for 66" wide
- short grain direction for 54" and 60" wide
- one end and back panel grommet
- one surface grommet
- shell units are not designed to accept modular pedestals from pages 97 and 98 ▲

Bullet Return	60	30	1 3/16	91	4	VL3060BRET	\$468	\$492
Bullet Return	48	30	1 3/16	68	4	VL3048BRET	\$431	\$453
Bullet Return	60	24	1 3/16	70	3	VL2460BRET	\$412	\$433
Bullet Return	48	24	1 3/16	55	3	VL2448BRET	\$370	\$389

grain

- edge profile on three open sides
- short grain direction ▲
- includes hardware to attach flat end to desk top
- base must be purchased separately, see below

### Bases for Bullet Return

**Column Base**

- 04BB - Black Sandtex - \$321
- 04SB - Stardust Silver - \$321

Base:

- 13 gauge steel
- 4" diameter

**Column Disk Base**

- 12DB - Black Sandtex - \$385
- 12DS - Stardust Silver - \$385

Base:

- support disk: 11" diameter

**H Base**

use with 36" or 48" deep tops

- 24HB - Black Sandtex - \$354
- 24HS - Stardust Silver - \$354

use with 30" deep tops

- 18HB - Black Sandtex - \$333
- 18HS - Stardust Silver - \$333

**U Base**

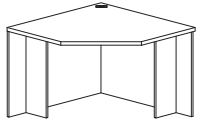
use with 36" or 48" deep tops

- 24UB - Black Sandtex - \$354
- 24US - Stardust Silver - \$354

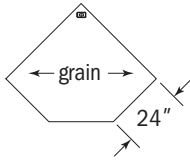
use with 30" deep tops

- 18UB - Black Sandtex - \$333
- 18US - Stardust Silver - \$333

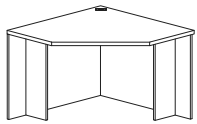
Description	D	W	H	CTN WT	CU FT	① Model	TFL List Price	HPL List Price
Corner Unit	42	42	30	162	36	VL4242-24ECU	\$1,296	\$1,363
<b>NOW!</b>	36	36	30	132	27	VL3636-24ECU	\$1,181	\$1,243



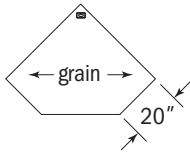
- angle grain on top
- top edge profile on user side
- two end panel grommets
- one surface grommet



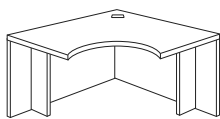
Corner Unit	42	42	30	162	36	VL4242-20ECU	\$1,296	\$1,363
<b>NOW!</b>	36	36	30	132	27	VL3636-20ECU	\$1,181	\$1,243



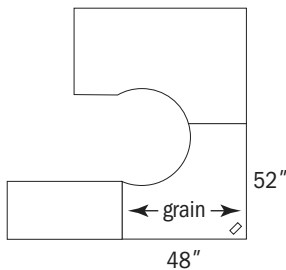
- angle grain on top
- top edge profile on user side
- two end panel grommets
- one surface grommet



Cockpit Corner Unit	48	52	30	180	50	VL4852ERCU	\$1,575	\$1,657
<b>NOW!</b>	48	52	30	180	50	VL4852ELCU	\$1,575	\$1,657



- parallel grain to 48" side of top
- top edge profile on user side
- two end panel grommets
- one surface grommet
- attaches to 24" return



right shown

**To Order, Specify:**

- ① Model Number
- ② Worksurface Material (see page 38)
  - a.) TFL
  - b.) HPL
- ③ Laminate Color (see page 38)
  - a.) Worksurface Color
  - b.) Chassis Color
- ④ Edge Profile (see page 43)
- ⑤ Grommet Color - Matte Black (MBK) or Stardust Silver (STS) (see page 44)
- ⑥ Other Product Options (see page 39)
- ⑦ Accessories (see page 407)
- ⑧ Power and Data Options (see page 407)


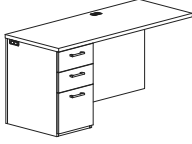
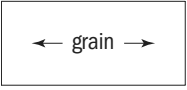
When ordering Quickship products, place a "Q" in front of model number.  
Example: QVL3072DD



Description	D	W	H	CTN WT	CU FT	① Model	TFL List Price	HPL List Price
File/File Corner Return	24	60	30	190	30	VL2460ERCR	\$1,287	\$1,354
 <p>left shown</p> 	24	60	30	190	30	VL2460ELCR	\$1,287	\$1,354
	24	54	30	179	27	VL2454ERCR	\$1,184	\$1,246
	24	54	30	179	27	VL2454ELCR	\$1,184	\$1,246
	24	48	30	168	25	VL2448ERCR	\$987	\$1,039
	24	48	30	168	25	VL2448ELCR	\$987	\$1,039
	24	42	30	155	22	VL2442ERCR	\$926	\$974
	24	42	30	155	22	VL2442ELCR	\$926	\$974
	20	60	30	173	26	VL2060ERCR	\$1,236	\$1,300
	20	60	30	173	26	VL2060ELCR	\$1,236	\$1,300
	20	54	30	163	23	VL2054ERCR	\$1,138	\$1,197
	20	54	30	163	23	VL2054ELCR	\$1,138	\$1,197
	20	48	30	154	21	VL2048ERCR	\$949	\$998
	20	48	30	154	21	VL2048ELCR	\$949	\$998
	20	42	30	142	18	VL2042ERCR	\$889	\$935
	20	42	30	142	18	VL2042ELCR	\$889	\$935

- top edge profile on user side
- long grain direction
- one end and back panel grommet with wire pass thru
- one surface grommet
- letter width file/file pedestal
- pedestal front locking
- optional 10" modesty panel available in place of full modesty, specify 10" modesty and indicate color on order

VISION - LAMINATE

Description	D	W	H	CTN WT	CU FT	① Model	TFL List Price	HPL List Price
Box/Box/File Corner Return	24	60	30	190	30	VL2460ERCY	\$1,287	\$1,354
	24	60	30	190	30	VL2460ELCY	\$1,287	\$1,354
	24	54	30	179	27	VL2454ERCY	\$1,184	\$1,246
left shown	24	54	30	179	27	VL2454ELCY	\$1,184	\$1,246
	24	48	30	168	25	VL2448ERCY	\$987	\$1,039
	24	48	30	168	25	VL2448ELCY	\$987	\$1,039
	24	42	30	155	22	VL2442ERCY	\$926	\$974
	24	42	30	155	22	VL2442ELCY	\$926	\$974
	20	60	30	173	26	VL2060ERCY	\$1,236	\$1,300
	20	60	30	173	26	VL2060ELCY	\$1,236	\$1,300
	20	54	30	163	23	VL2054ERCY	\$1,138	\$1,197
	20	54	30	163	23	VL2054ELCY	\$1,138	\$1,197
	20	48	30	154	21	VL2048ERCY	\$949	\$998
	20	48	30	154	21	VL2048ELCY	\$949	\$998
	20	42	30	142	18	VL2042ERCY	\$889	\$935
	20	42	30	142	18	VL2042ELCY	\$889	\$935


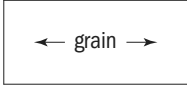
- top edge profile on user side
- long grain direction
- one end and back panel grommet with wire pass thru
- one surface grommet
- letter width box/box/file pedestal
- pedestal front locking
- optional 10" modesty panel available in place of full modesty, specify 10" modesty and indicate color on order

### To Order, Specify:


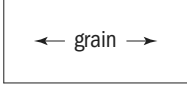
- ① Model Number
- ▲ ② Worksurface Material (see page 38)
  - a.) TFL
  - b.) HPL
- ③ Laminate Color (see page 38)
  - a.) Worksurface Color
  - b.) Chassis Color
  - c.) Drawer Color
- ④ Edge Profile (see page 43)
- ⑤ Pull Style and Color (see page 43)
- ⑥ Grommet Color - Matte Black (MBK) or Stardust Silver (STS) (see page 44)
- ⑦ Other Product Options (see page 39)
- ⑧ Accessories (see page 407)
- ⑨ Power and Data Options (see page 407)

When ordering Quickship products, place a "Q" in front of model number.  
Example: QVL3072DD


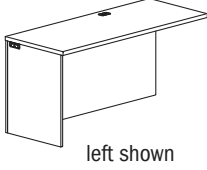
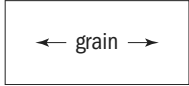


Description	D	W	H	CTN WT	CU FT	① Model	TFL List Price	HPL List Price
<b>Lateral File Corner Return</b>  left shown 	24	60	30	199	30	VL2460LRCR	\$1,599	\$1,683
	24	60	30	199	30	VL2460LLCR	\$1,599	\$1,683
	24	54	30	187	27	VL2454LRCR	\$1,401	\$1,475
	24	54	30	187	27	VL2454LLCR	\$1,401	\$1,475
	24	48	30	175	25	VL2448LRCR	\$1,340	\$1,411
	24	48	30	175	25	VL2448LLCR	\$1,340	\$1,411
	20	60	30	188	26	VL2060LRCR	\$1,536	\$1,615
	20	60	30	188	26	VL2060LLCR	\$1,536	\$1,615
	20	54	30	177	23	VL2054LRCR	\$1,346	\$1,416
	20	54	30	177	23	VL2054LLCR	\$1,346	\$1,416
	20	48	30	164	21	VL2048LRCR	\$1,288	\$1,355
	20	48	30	164	21	VL2048LLCR	\$1,288	\$1,355

- top edge profile on user side
- long grain direction
- one end and back panel grommet with wire pass thru
- one surface grommet
- 36" width lateral file
- pedestal front locking
- optional 10" modesty panel available in place of full modesty, specify 10" modesty and indicate color on order

<b>Multi-File Corner Return</b>  left shown 	24	60	30	202	30	VL2460MRCR	\$1,716	\$1,806
	24	60	30	202	30	VL2460MLCR	\$1,716	\$1,806
	24	54	30	190	27	VL2454MRCR	\$1,614	\$1,698
	24	54	30	190	27	VL2454MLCR	\$1,614	\$1,698
	24	48	30	179	25	VL2448MRCR	\$1,417	\$1,491
	24	48	30	179	25	VL2448MLCR	\$1,417	\$1,491
	20	60	30	191	26	VL2060MRCR	\$1,649	\$1,735
	20	60	30	191	26	VL2060MLCR	\$1,649	\$1,735
	20	54	30	180	23	VL2054MRCR	\$1,551	\$1,632
	20	54	30	180	23	VL2054MLCR	\$1,551	\$1,632
	20	48	30	167	21	VL2048MRCR	\$1,360	\$1,432
	20	48	30	167	21	VL2048MLCR	\$1,360	\$1,432

- top edge profile on user side
- long grain direction
- one end and back panel grommet with wire pass thru
- one surface grommet
- 30" width multi-file
- pedestal front locking
- optional 10" modesty panel available in place of full modesty, specify 10" modesty and indicate color on order

Description	D	W	H	CTN WT	CU FT	① Model	TFL List Price	HPL List Price
Shell Corner Return	24	72	30	153	36	VL2472RSHCR	\$832	\$875
 24	24	72	30	153	36	VL2472LSHCR	\$832	\$875
	24	66	30	147	33	VL2466RSHCR	\$774	\$814
	24	66	30	147	33	VL2466LSHCR	\$774	\$814
	24	60	30	141	30	VL2460RSHCR	\$752	\$791
	24	60	30	141	30	VL2460LSHCR	\$752	\$791
	24	54	30	136	27	VL2454RSHCR	\$730	\$768
	24	54	30	136	27	VL2454LSHCR	\$730	\$768
	24	48	30	130	25	VL2448RSHCR	\$709	\$746
	24	48	30	130	25	VL2448LSHCR	\$709	\$746
	24	42	30	124	22	VL2442RSHCR	\$687	\$723
	24	42	30	124	22	VL2442LSHCR	\$687	\$723
	24	36	30	120	19	VL2436RSHCR	\$667	\$702
	24	36	30	120	19	VL2436LSHCR	\$667	\$702
	20	72	30	142	31	VL2072RSHCR	\$800	\$842
	20	72	30	142	31	VL2072LSHCR	\$800	\$842
	20	66	30	138	28	VL2066RSHCR	\$744	\$783
	20	66	30	138	28	VL2066LSHCR	\$744	\$783
	20	60	30	135	26	VL2060RSHCR	\$723	\$761
	20	60	30	135	26	VL2060LSHCR	\$723	\$761
	20	54	30	129	23	VL2054RSHCR	\$700	\$737
	20	54	30	129	23	VL2054LSHCR	\$700	\$737
	20	48	30	125	21	VL2048RSHCR	\$681	\$717
	20	48	30	125	21	VL2048LSHCR	\$681	\$717
	20	42	30	119	18	VL2042RSHCR	\$660	\$695
	20	42	30	119	18	VL2042LSHCR	\$660	\$695
	20	36	30	115	16	VL2036RSHCR	\$641	\$675
	20	36	30	115	16	VL2036LSHCR	\$641	\$675


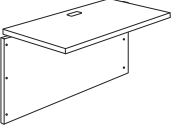
- top edge profile on user side
- long grain direction
- one end and back panel grommet with wire pass thru
- one surface grommet
- optional 10" modesty panel available in place of full modesty, specify 10" modesty and indicate color on order
- shell units are not designed to accept modular pedestals from pages 97 and 98 ▲

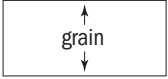
**To Order, Specify:**

- ① Model Number
- ▲ ② Worksurface Material (see page 38)
  - a.) TFL
  - b.) HPL
- ③ Laminate Color (see page 38)
  - a.) Worksurface Color
  - b.) Chassis Color
  - c.) Drawer Color
- ④ Edge Profile (see page 43)
- ⑤ Pull Style and Color (see page 43)
- ⑥ Grommet Color - Matte Black (MBK) or Stardust Silver (STS) (see page 44)
- ⑦ Other Product Options (see page 39)
- ⑧ Accessories (see page 407)
- ⑨ Power and Data Options (see page 407)

When ordering Quickship products, place a "Q" in front of model number.  
Example: QVL3072DD



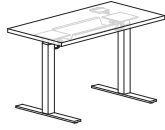
Description	D	W	H	CTN WT	CU FT	① Model	TFL List Price	HPL List Price
Bridge with Modesty Panel	24	48	30	112	4	VL2448EB	\$452	\$475
 	24	42	30	109	3	VL2442EB	\$434	\$456
	24	36	30	101	3	VL2436EB	\$416	\$437
	20	48	30	104	4	VL2048EB	\$435	\$457
	20	42	30	102	3	VL2042EB	\$416	\$437
	20	36	30	96	3	VL2036EB	\$399	\$420



- top edge profile on user side
- short grain direction
- one back panel grommet
- one surface grommet

VISION - LAMINATE

Description	D	W	H	CTN WT	CU FT	① Model	TFL List Price	HPL List Price
<b>Electric Adjustable Height Bridge</b>	24	46	Adj.	90	9	VL2446AHB-EL	\$2,800	\$2,895
	24	40	Adj.	85	8	VL2440AHB-EL	\$2,806	\$2,889



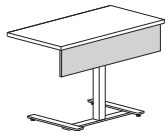
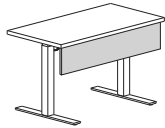
- 27 1/2" to 44 1/2" height adjustment
- top edge profile on user and approach sides
- push button control pad mounted right or left
- key pad features height display with four memory settings
- 72" power cord
- 225 lb. max load
- specify Black Sandtex (BSX) or Stardust Silver (STS) base finish
- ships KD

<b>Pneumatic Adjustable Height Bridge</b>	24	46	Adj.	90	9	VL2446AHB-PN	\$2,170	\$2,266
	24	40	Adj.	85	8	VL2440AHB-PN	\$2,120	\$2,203



- 27 1/2" to 44 1/2" height adjustment
- top edge profile on user and approach sides
- release lever mounts under edge of top
- may be used in place of standard bridge
- 1" gap between credenza or desk top avoids pinch point
- can be used as freestanding table
- 180 lb. max load
- specify Matte Black or Alloy base finish
- ships KD

							List Price
<b>Modesty Panel for Adjustable Height Bridge</b>	3/4	46	9	13	2	VL0946TDM	\$300
	3/4	40	9	11	2	VL0940TDM	\$290



- VL0946TDM use with 46" wide adjustable height bridge
- VL0940TDM use with 40" wide adjustable height bridge
- flat edge detail
- modesty panel bracket is available in Black Sandtex (BSX) or Stardust Silver (STS)

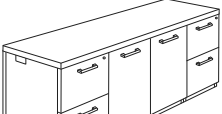
**To Order, Specify:**

- ① Model Number
- ▲ ② Worksurface Material (see page 38)
  - a.) TFL
  - b.) HPL
- ③ Laminate Color (see page 38)
  - a.) Worksurface Color
  - b.) Chassis Color
- ④ Edge Profile (see page 43)
- ⑤ Metal Color (see page 47)
- ⑥ Grommet Color - Matte Black (MBK) or Stardust Silver (STS) (see page 44)
- ⑦ Other Product Options (see page 39)
- ⑧ Accessories (see page 407)
- ⑨ Power and Data Options (see page 407)


When ordering Quickship products, place a "Q" in front of model number.  
Example: QVL3072DD





Description	D	W	H	CTN WT	CU FT	① Model	TFL List Price	HPL List Price
Storage Credenza 	24	72	30	309	36	VL2472SC	\$1,836	\$1,932
	24	66	30	285	33	VL2466SC	\$1,722	\$1,813
	20	72	30	284	31	VL2072SC	\$1,762	\$1,855
	20	66	30	255	28	VL2066SC	\$1,655	\$1,741

- file/file pedestals - letter width
- top edge profile on user side
- two end panel grommets with wire pass thru
- adjustable shelf in storage cabinet
- pedestal front locking
- locking doors available, specify and add \$105 list

Lateral File Credenza 	24	72	30	248	39	VL2472LFC	\$2,452	\$2,580
	24	60	30	243	30	VL2460LFC	\$2,355	\$2,478
	20	72	30	223	36	VL2072LFC	\$2,355	\$2,477
	20	60	30	220	26	VL2060LFC	\$2,261	\$2,380

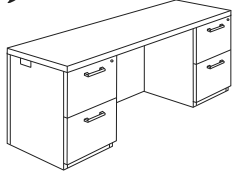
- two drawer lateral files side by side
- top edge profile on user side
- two end panel grommets with wire pass thru
- pedestal front locking

Four Door Credenza 	24	72	30	293	36	VL2472DSC	\$1,785	\$1,879
	24	60	30	287	30	VL2460DSC	\$1,695	\$1,783
	20	72	30	268	36	VL2072DSC	\$1,715	\$1,804
	20	60	30	266	26	VL2060DSC	\$1,628	\$1,713

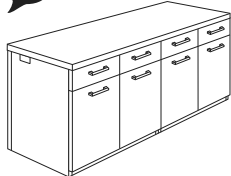
- top edge profile on user side
- two end panel grommets with wire pass thru
- adjustable shelf in storage cabinets
- locking doors available, specify and add \$210 list

Two Door Credenza 	24	36	30	133	19	VL2436SC	\$1,044	\$1,099
	24	30	30	129	16	VL2430SC	\$882	\$929
	20	36	30	121	16	VL2036SC	\$1,003	\$1,056
	20	30	30	119	14	VL2030SC	\$848	\$892


- top edge profile on user side
- two end panel grommets with wire pass thru
- one adjustable shelf
- locking doors available, specify and add \$105 list

Description	D	W	H	CTN WT	CU FT	① Model	TFL List Price	HPL List Price
<b>Kneespace Credenza</b> 	24	84	30	299	42	VL2484KC	\$2,032	\$2,138
	24	78	30	280	39	VL2478KC	\$1,917	\$2,018
	24	72	30	261	36	VL2472KC	\$1,687	\$1,775
	24	66	30	243	33	VL2466KC	\$1,563	\$1,645
	24	60	30	231	30	VL2460KC	\$1,536	\$1,615
	20	84	30	270	36	VL2084KC	\$1,951	\$2,053
	20	78	30	253	33	VL2078KC	\$1,840	\$1,937
	20	72	30	236	31	VL2072KC	\$1,620	\$1,705
	20	66	30	220	28	VL2066KC	\$1,501	\$1,580
	20	60	30	210	26	VL2060KC	\$1,476	\$1,552

- file/file pedestals - letter width
- top edge profile on user side
- one back and two end panel grommets with wire pass thru
- pedestal front locking
- kneespace for VL2484KC and VL2084KC - 52 5/8"
- kneespace for VL2478KC and VL2078KC - 46 5/8"
- kneespace for VL2472KC and VL2072KC - 40 5/8"
- kneespace for VL2466KC and VL2066KC - 34 5/8"
- kneespace for VL2460KC and VL2060KC - 28 5/8"
- optional 10" modesty panel available in place of full modesty, specify 10" modesty and indicate color on order

<b>Buffet Credenza</b> 	24	72	36	316	43	VL2472BSC	\$2,162	\$2,276
	20	72	36	291	31	VL2072BSC	\$2,076	\$2,186

- four door credenza
- four box drawers above doors
- top edge profile on user side
- two end panel grommets with wire pass thru
- adjustable shelf in storage cabinets
- locking doors and drawers not available

<b>Buffet Credenza</b> 	24	36	36	167	22	VL2436BSC	\$1,433	\$1,507
	20	36	36	155	16	VL2036BSC	\$1,375	\$1,446

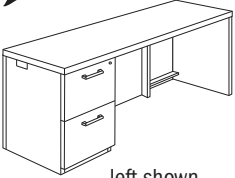
- two door credenza
- two box drawers above doors
- top edge profile on user side
- two end panel grommets with wire pass thru
- adjustable shelf in storage cabinet
- locking doors and drawers not available

**To Order, Specify:**

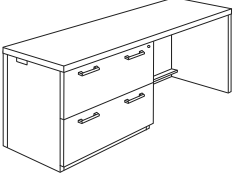
- ① Model Number
- ▲ ② Worksurface Material (see page 38)
  - a.) TFL
  - b.) HPL
- ③ Laminate Color (see page 38)
  - a.) Worksurface Color
  - b.) Chassis Color
  - c.) Drawer Color
- ④ Edge Profile (see page 43)
- ⑤ Pull Style and Color (see page 43)
- ⑥ Grommet Color - Matte Black (MBK) or Stardust Silver (STS) (see page 44)
- ⑦ Other Product Options (see page 39)
- ⑧ Accessories (see page 407)
- ⑨ Power and Data Options (see page 407)

When ordering Quickship products, place a "Q" in front of model number.  
 Example: QVL3072DD

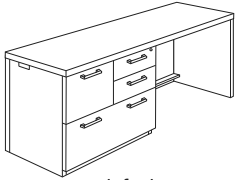
**NOW!**  
 Need it.  
 JSI Quickship

Description	D	W	H	CTN WT	CU FT	① Model	TFL List Price	HPL List Price
<b>File/File Pedestal Credenza</b>  left shown	24	84	30	248	42	VL2484RC	\$1,317	\$1,385
	24	84	30	248	42	VL2484LC	\$1,317	\$1,385
	24	78	30	237	39	VL2478RC	\$1,266	\$1,332
	24	78	30	237	39	VL2478LC	\$1,266	\$1,332
	24	72	30	226	36	VL2472RC	\$1,217	\$1,280
	24	72	30	226	36	VL2472LC	\$1,217	\$1,280
	24	66	30	212	33	VL2466RC	\$1,203	\$1,266
	24	66	30	212	33	VL2466LC	\$1,203	\$1,266
	24	60	30	179	30	VL2460RC	\$1,191	\$1,253
	24	60	30	179	30	VL2460LC	\$1,191	\$1,253
20	84	30	238	36	VL2084RC	\$1,265	\$1,331	
20	84	30	238	36	VL2084LC	\$1,265	\$1,331	
20	78	30	227	33	VL2078RC	\$1,217	\$1,280	
20	78	30	227	33	VL2078LC	\$1,217	\$1,280	
20	72	30	216	31	VL2072RC	\$1,168	\$1,229	
20	72	30	216	31	VL2072LC	\$1,168	\$1,229	
20	66	30	203	28	VL2066RC	\$1,155	\$1,215	
20	66	30	203	28	VL2066LC	\$1,155	\$1,215	
20	60	30	171	26	VL2060RC	\$1,143	\$1,203	
20	60	30	171	26	VL2060LC	\$1,143	\$1,203	

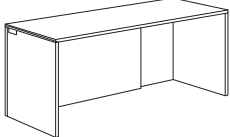
- top edge profile on user side
- one back panel grommet and two end panel grommets with wire pass thru
- letter width pedestal
- pedestal front locking
- optional 10" modesty panel available in place of full modesty, specify 10" modesty and indicate color on order

<b>Lateral File Pedestal Credenza</b>  left shown	24	84	30	256	42	VL2484LRC	\$1,689	\$1,777
	24	84	30	256	42	VL2484LLC	\$1,689	\$1,777
	24	78	30	244	39	VL2478LRC	\$1,623	\$1,708
	24	78	30	244	39	VL2478LLC	\$1,623	\$1,708
	24	72	30	232	36	VL2472LRC	\$1,560	\$1,642
	24	72	30	232	36	VL2472LLC	\$1,560	\$1,642
	20	84	30	245	36	VL2084LRC	\$1,622	\$1,707
	20	84	30	245	36	VL2084LLC	\$1,622	\$1,707
	20	78	30	233	33	VL2078LRC	\$1,558	\$1,640
	20	78	30	233	33	VL2078LLC	\$1,558	\$1,640
20	72	30	221	31	VL2072LRC	\$1,499	\$1,578	
20	72	30	221	31	VL2072LLC	\$1,499	\$1,578	

- top edge profile on user side
- one back panel grommet and two end panel grommets with wire pass thru
- 36" width lateral file
- pedestal front locking
- optional 10" modesty panel available in place of full modesty, specify 10" modesty and indicate color on order

Description	D	W	H	CTN WT	CU FT	① Model	TFL List Price	HPL List Price
<b>Multi-File Pedestal Credenza</b>  left shown	24	84	30	260	42	VL2484MRC	\$1,773	\$1,865
	24	84	30	260	42	VL2484MLC	\$1,773	\$1,865
	24	78	30	248	39	VL2478MRC	\$1,704	\$1,793
	24	78	30	248	39	VL2478MLC	\$1,704	\$1,793
	24	72	30	235	36	VL2472MRC	\$1,637	\$1,724
	24	72	30	235	36	VL2472MLC	\$1,637	\$1,724
	20	84	30	249	36	VL2084MRC	\$1,703	\$1,792
	20	84	30	249	36	VL2084MLC	\$1,703	\$1,792
	20	78	30	237	33	VL2078MRC	\$1,636	\$1,721
	20	78	30	237	33	VL2078MLC	\$1,636	\$1,721
	20	72	30	225	31	VL2072MRC	\$1,573	\$1,655
	20	72	30	225	31	VL2072MLC	\$1,573	\$1,655

- top edge profile on user side
- one back panel grommet and two end panel grommets with wire pass thru
- 30" width multi-file
- pedestal front locking
- optional 10" modesty panel available in place of full modesty, specify 10" modesty and indicate color on order

<b>Shell Credenza</b> 	24	72	30	159	36	VL2472SHD	\$951	\$1,000
	24	66	30	153	33	VL2466SHD	\$896	\$942

- top edge profile on user side
- one back panel grommet and two end panel grommets
- shell units are not designed to accept modular pedestals from pages 97 and 98 ▲

**To Order, Specify:**

- ① Model Number
- ▲ ② Worksurface Material (see page 38)
  - a.) TFL
  - b.) HPL
- ③ Laminate Color (see page 38)
  - a.) Worksurface Color
  - b.) Chassis Color
  - c.) Drawer Color
- ④ Edge Profile (see page 43)
- ⑤ Pull Style and Color (see page 43)
- ⑥ Grommet Color - Matte Black (MBK) or Stardust Silver (STS) (see page 44)
- ⑦ Other Product Options (see page 39)
- ⑧ Accessories (see page 407)
- ⑨ Power and Data Options (see page 407)

When ordering Quickship products, place a "Q" in front of model number.  
 Example: QVL3072DD



## Modular

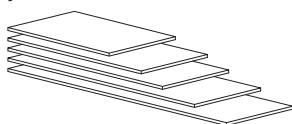
Description	D	W	H	CTN WT	CU FT	① Model	TFL List Price	HPL List Price
Modular Bow Front Desk Top	42	72	1 3/16	130	12	VL4272BMCT	\$1,119	\$1,253
<b>NOW!</b>	36	72	1 3/16	110	9	VL3672BMCT	\$1,033	\$1,157



- top edge profile on user and approach sides
- long grain direction

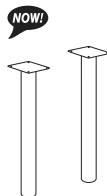


Description	D	W	H	CTN WT	CU FT	① Model	TFL List Price	HPL List Price
Modular Rectangular Desk Top	36	72	1 3/16	117	9	VL3672MCT	\$609	\$683
<b>NOW!</b>	36	66	1 3/16	108	9	VL3666MCT	\$499	\$559
	30	72	1 3/16	98	8	VL3072MCT	\$454	\$509
	30	66	1 3/16	90	7	VL3066MCT	\$416	\$467
	30	60	1 3/16	82	7	VL3060MCT	\$378	\$424
	30	54	1 3/16	74	6	VL3054MCT	\$341	\$382
	30	48	1 3/16	65	5	VL3048MCT	\$303	\$340
	30	42	1 3/16	57	4	VL3042MCT	\$265	\$298



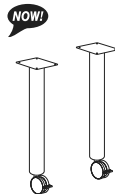
- top edge profile on user and approach sides
- long grain direction

Description	D	W	H	CTN WT	CU FT	① Model	List Price
Metal Legs	2	2	28	12	1	VS28LEG2	\$269



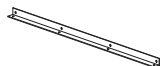
- set of two legs
- 2" diameter column
- 6" square mounting plate
- wood screws included for attachment to top
- specify Black Sandtex (BSX) or Stardust Silver (STS) base finish

Metal Legs with Casters	2	2	28	12	1	VS28LEGC2	\$280
-------------------------	---	---	----	----	---	-----------	-------



- set of two legs
- 2" diameter column
- 6" square mounting plate
- wood screws included for attachment to top
- specify Black Sandtex (BSX) or Stardust Silver (STS) base finish
- black nylon locking casters

L-Bracket	1	27	1	4	1	VS-LBRKT-30	\$74
<b>NOW!</b>	1	21	1	4	1	VS-LBRKT-24	\$69
	1	17	1	3	1	VS-LBRKT-20	\$65



- attach to tall storage or wall
- matte black
- VS-LBRKT-30 typically used with 30" deep tops
- VS-LBRKT-24 typically used with 24" deep tops
- VS-LBRKT-20 typically used with 20" deep tops

**Modular**

Description	D	W	H	CTN WT	CU FT	① Model	TFL List Price	HPL List Price
Modular Credenza Top	24	108	1 3/16	117	10	VL24108MCT	\$689	\$773
	24	102	1 3/16	111	10	VL24102MCT	\$651	\$731
	24	96	1 3/16	104	9	VL2496MCT	\$614	\$688
	24	90	1 3/16	98	9	VL2490MCT	\$552	\$620
	24	84	1 3/16	91	8	VL2484MCT	\$510	\$573
	24	78	1 3/16	85	8	VL2478MCT	\$482	\$541
	24	72	1 3/16	78	7	VL2472MCT	\$432	\$486
	24	66	1 3/16	72	7	VL2466MCT	\$412	\$464
	24	60	1 3/16	65	6	VL2460MCT	\$375	\$422
	24	54	1 3/16	59	6	VL2454MCT	\$369	\$415
	24	48	1 3/16	52	5	VL2448MCT	\$300	\$336
	24	42	1 3/16	46	4	VL2442MCT	\$258	\$289
	24	36	1 3/16	39	4	VL2436MCT	\$257	\$288
	24	30	1 3/16	33	3	VL2430MCT	\$235	\$264
	20	108	1 3/16	98	9	VL20108MCT	\$655	\$735
	20	102	1 3/16	93	8	VL20102MCT	\$619	\$696
	20	96	1 3/16	87	8	VL2096MCT	\$583	\$655
	20	90	1 3/16	82	8	VL2090MCT	\$524	\$588
	20	84	1 3/16	76	7	VL2084MCT	\$485	\$544
	20	78	1 3/16	71	7	VL2078MCT	\$458	\$515
	20	72	1 3/16	65	6	VL2072MCT	\$411	\$461
20	66	1 3/16	60	6	VL2066MCT	\$392	\$440	
20	60	1 3/16	55	5	VL2060MCT	\$357	\$402	
20	54	1 3/16	49	5	VL2054MCT	\$351	\$394	
20	48	1 3/16	44	4	VL2048MCT	\$286	\$321	
20	42	1 3/16	38	4	VL2042MCT	\$245	\$276	
20	36	1 3/16	33	3	VL2036MCT	\$244	\$273	
20	30	1 3/16	28	3	VL2030MCT	\$223	\$250	

- top edge profile on user side
- long grain direction


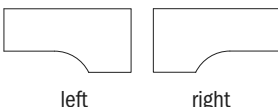
**To Order, Specify:**

- ① Model Number
- ▲ ② Worksurface Material (see page 38)
  - a.) TFL
  - b.) HPL
- ③ Laminate Color (see page 38)
- ④ Edge Profile (see page 43)
- ⑤ Metal Color (see page 47)

When ordering Quickship products, place a "Q" in front of model number.  
Example: QVL3072DD



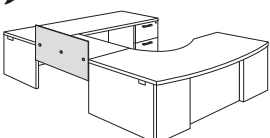
**Modular**

Description	D	W	H	CTN WT	CU FT	① Model	TFL List Price	HPL List Price
<b>Modular Extended Corner Credenza Top</b>   left shown   left      right	36	96	1 3/16	117	13	VL3696MCCT24R	\$1,017	\$1,142
	36	96	1 3/16	117	13	VL3696MCCT24L	\$1,017	\$1,142
	36	90	1 3/16	111	13	VL3690MCCT24R	\$983	\$1,105
	36	90	1 3/16	111	13	VL3690MCCT24L	\$983	\$1,105
	36	84	1 3/16	104	12	VL3684MCCT24R	\$961	\$1,080
	36	84	1 3/16	104	12	VL3684MCCT24L	\$961	\$1,080
	36	72	1 3/16	91	10	VL3672MCCT24R	\$763	\$856
	36	72	1 3/16	91	10	VL3672MCCT24L	\$763	\$856
	36	66	1 3/16	85	9	VL3666MCCT24R	\$733	\$824
	36	66	1 3/16	85	9	VL3666MCCT24L	\$733	\$824
	36	60	1 3/16	78	9	VL3660MCCT24R	\$697	\$783
	36	60	1 3/16	78	9	VL3660MCCT24L	\$697	\$783
	36	54	1 3/16	71	8	VL3654MCCT24R	\$664	\$746
	36	54	1 3/16	71	8	VL3654MCCT24L	\$664	\$746

- top edge profile on user side
- long grain direction

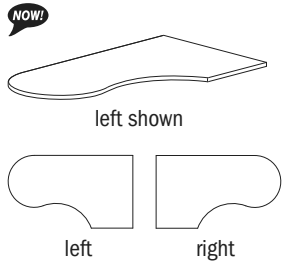
Description	D	W	H	CTN WT	CU FT	Model	List Price	HPL List Price
<b>Modular Return/Bridge Top</b>    	24	60	1 3/16	65	6	VL6024MCT	\$437	\$491
	24	54	1 3/16	59	6	VL5424MCT	\$430	\$482
	24	48	1 3/16	52	5	VL4824MCT	\$361	\$405
	24	42	1 3/16	46	4	VL4224MCT	\$319	\$357
	24	36	1 3/16	39	4	VL3624MCT	\$317	\$355
	20	60	1 3/16	55	5	VL6020MCT	\$416	\$467
	20	54	1 3/16	49	5	VL5420MCT	\$409	\$458
	20	48	1 3/16	44	4	VL4820MCT	\$343	\$385
	20	42	1 3/16	38	4	VL4220MCT	\$303	\$340
	20	36	1 3/16	33	3	VL3620MCT	\$301	\$339

- top edge profile on user side
- short grain direction
- one surface grommet

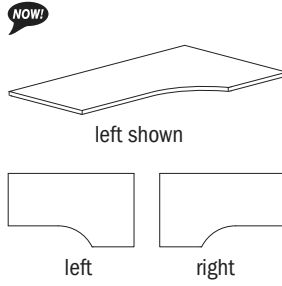
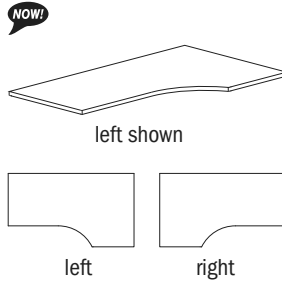
Description	D	W	H	CTN WT	CU FT	Model	List Price
<b>Bridge Panel Screen</b>  	1/4	48	20	8	2	VS2048FPS	\$490
	1/4	42	20	8	2	VS2042FPS	\$483
	1/4	36	20	7	2	VS2036FPS	\$479

- mounts to bridge top
- acrylic panel - frosted
- aluminum decorative mounting screws
- field installed

**Modular**

Description	D	W	H	CTN WT	CU FT	① Model	TFL List Price	HPL List Price
<b>Modular Extended Corner</b>	48	72	1 3/16	130	13	VL4872MCBT24R	\$1,393	\$1,565
<b>Bullet Desk Top</b>	48	72	1 3/16	130	13	VL4872MCBT24L	\$1,393	\$1,565
 <p>left shown</p> <p>left right</p>	42	72	1 3/16	111	12	VL4272MCBT24R	\$1,220	\$1,370
	42	72	1 3/16	111	12	VL4272MCBT24L	\$1,220	\$1,370
	42	66	1 3/16	103	11	VL4266MCBT24R	\$1,119	\$1,256
	42	66	1 3/16	103	11	VL4266MCBT24L	\$1,119	\$1,256

- top edge profile on three open sides
- long grain direction
- supports located on pages 75, 96, and 98

 <p>left shown</p> <p>left right</p>	<b>Modular Extended Corner</b>	48	72	1 3/16	130	13	VL4872MCDT24R	\$1,017	\$1,142
	<b>Desk Top</b>	48	72	1 3/16	130	13	VL4872MCDT24L	\$1,017	\$1,142
	 <p>left shown</p> <p>left right</p>	42	72	1 3/16	111	12	VL4272MCDT24R	\$890	\$999
		42	72	1 3/16	111	12	VL4272MCDT24L	\$890	\$999
	48	66	1 3/16	120	12	VL4866MCDT24R	\$977	\$1,097	
	48	66	1 3/16	120	12	VL4866MCDT24L	\$977	\$1,097	
	42	66	1 3/16	103	11	VL4266MCDT24R	\$855	\$960	
	42	66	1 3/16	103	11	VL4266MCDT24L	\$855	\$960	

- top edge profile on three open sides
- long grain direction
- supports located on pages 75, 96, and 98

**To Order, Specify:**



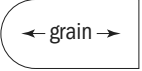
- ① Model Number
- ▲ ② Worksurface Material (see page 38)
  - a.) TFL
  - b.) HPL
- ③ Laminate Color (see page 38)
- ④ Edge Profile (see page 43)
- ⑤ Grommet Color (see page 44)

When ordering Quickship products, place a "Q" in front of model number.  
Example: QVL3072DD


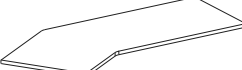




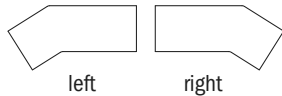
**Modular**


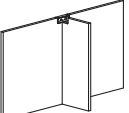
Description	D	W	H	CTN WT	CU FT	① Model	TFL List Price	HPL List Price
Modular Bullet Desk Top	36	84	1 3/16	137	12	VL3684MBULT	\$1,119	\$1,256
	36	78	1 3/16	127	11	VL3678MBULT	\$1,039	\$1,167
	36	72	1 3/16	117	10	VL3672MBULT	\$860	\$966
	30	72	1 3/16	98	9	VL3072MBULT	\$759	\$852
	30	66	1 3/16	90	8	VL3066MBULT	\$714	\$802
	24	60	1 3/16	65	6	VL2460MBULT	\$465	\$522
	24	48	1 3/16	52	5	VL2448MBULT	\$410	\$460

- top edge profile on three open sides
- long grain direction
- supports located below and on pages 75 and 98


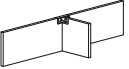
Modular Boomerang Desk Top	30	84	1 3/16	114	10	VL3084MBMTR	\$1,476	\$1,657
	30	84	1 3/16	114	10	VL3084MBMTL	\$1,476	\$1,657
	24	84	1 3/16	91	8	VL2484MBMTR	\$1,265	\$1,420
left shown	24	84	1 3/16	91	8	VL2484MBMTL	\$1,265	\$1,420

- top edge profile on three open sides
- long grain direction
- supports located below and on pages 75 and 98



Description	D	W	H	CTN WT	CU FT	① Model	List Price
Full Height "T" Supports	9 3/4	47 5/8	28	42	11	VL1048TSP	\$317
	9 3/4	41 5/8	28	38	9	VL1042TSP	\$302
	9 3/4	35 5/8	28	32	8	VL1036TSP	\$288
	9 3/4	29 5/8	28	28	7	VL1030TSP	\$276
	9 3/4	23 5/8	28	24	6	VL1024TSP	\$264

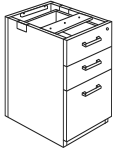
- use with peninsula or modular tops
- one end panel grommet

Bench Height "T" Supports	9 3/4	47 5/8	8 5/16	18	4	VLB1048TSP	\$294
	9 3/4	41 5/8	8 5/16	16	4	VLB1042TSP	\$278
	9 3/4	35 5/8	8 5/16	15	3	VLB1036TSP	\$266
	9 3/4	29 5/8	8 5/16	14	3	VLB1030TSP	\$256
	9 3/4	23 5/8	8 5/16	12	2	VLB1024TSP	\$243

- use with bench height credenza
- one end panel grommet

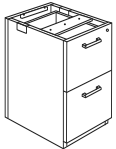
**Modular**

Description	D	W	H	CTN WT	CU FT	① Model	List Price
<b>Modular Box/Box/File Pedestal</b>	36	16	28	124	12	VL1636MBBF	\$835
<b>NOW!</b>	30	16	28	110	10	VL1630MBBF	\$771
	24	16	28	98	9	VL1624MBBF	\$718
	20	16	28	87	7	VL1620MBBF	\$695



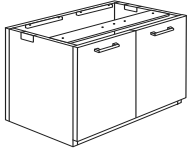
- two end panel grommets
- letter width pedestal
- pedestal front locking

<b>Modular File/File Pedestal</b>	36	16	28	124	12	VL1636MFF	\$835
<b>NOW!</b>	30	16	28	110	10	VL1630MFF	\$771
	24	16	28	98	9	VL1624MFF	\$718
	20	16	28	87	7	VL1620MFF	\$695



- two end panel grommets
- letter width pedestal
- pedestal front locking

<b>Modular Hinged Door Pedestal</b>	24	36	28	132	18	VL3624MSC	\$898
<b>NOW!</b>	20	36	28	120	15	VL3620MSC	\$707
	24	30	28	128	15	VL3024MSC	\$720
	20	30	28	116	13	VL3020MSC	\$684



- two end panel grommets
- adjustable shelf in storage cabinet
- locking doors available, specify and add \$105 list

**To Order, Specify:**

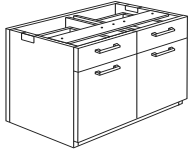
- ① Model Number
- ▲ ② Worksurface Material (see page 38)
  - a.) TFL
  - b.) HPL
- ③ Laminate Color (see page 38)
  - a.) Worksurface Color
  - b.) Chassis Color
  - c.) Drawer Color
- ④ Edge Profile (see page 43)
- ⑤ Pull Style and Color (see page 43)
- ⑥ Grommet Color - Matte Black (MBK) or Stardust Silver (STS) (see page 44)
- ⑦ Other Product Options (see page 39)
- ⑧ Accessories (see page 407)
- ⑨ Power and Data Options (see page 407)

When ordering Quickship products, place a "Q" in front of model number.  
Example: QVL3072DD



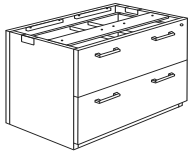
## Modular

Description	D	W	H	CTN WT	CU FT	① Model	List Price
Modular Buffet Door Pedestal	24	36	34	147	21	VL3624MBSC	\$1,085
<b>NOW!</b>	20	36	34	131	18	VL3620MBSC	\$1,031



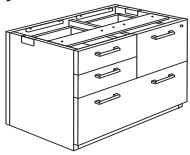
- two end panel grommets
- adjustable shelf in storage cabinet
- locking not available

Modular Lateral File Pedestal	24	36	28	148	18	VL3624MLF	\$937
<b>NOW!</b>	20	36	28	133	15	VL3620MLF	\$891
	24	30	28	140	15	VL3024MLF	\$878
	20	30	28	128	13	VL3020MLF	\$835



- two end panel grommets
- pedestal front locking

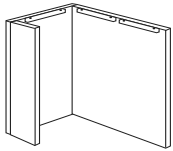
Modular Multi-File Pedestal	24	30	28	152	15	VL3024MRM	\$1,039
<b>NOW!</b>	24	30	28	152	15	VL3024MLM	\$1,039
	20	30	28	137	13	VL3020MRM	\$987
	20	30	28	137	13	VL3020MLM	\$987



right shown

- two end panel grommets
- pedestal front locking
- top file drawer determines left or right

Wing End Support	48	16	28	58	16	VL1648WEAR	\$296
<b>NOW!</b>	48	16	28	58	16	VL1648WEAL	\$296
	42	16	28	54	14	VL1642WEAR	\$282
	42	16	28	54	14	VL1642WEAL	\$282
	36	16	28	50	12	VL1636WEAR	\$269
	36	16	28	50	12	VL1636WEAL	\$269
	30	16	28	45	10	VL1630WEAR	\$258
	30	16	28	45	10	VL1630WEAL	\$258
	24	16	28	41	9	VL1624WEAR	\$248
	24	16	28	41	9	VL1624WEAL	\$248
	20	16	28	37	7	VL1620WEAR	\$237
	20	16	28	37	7	VL1620WEAL	\$237

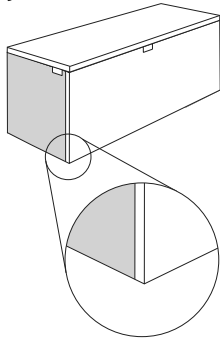


right shown

- one end panel grommet

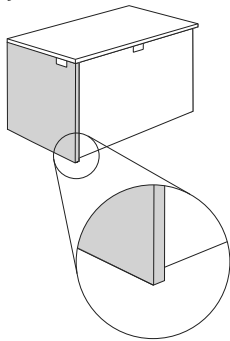
**Modular**

Description	D	W	H	CTN WT	CU FT	① Model	List Price
<b>Modular End Panel for Shell Desks and Credenzas</b>	3/4	46 1/4	28	31	4	VL47EP	\$298
	3/4	40 1/4	28	27	4	VL41EP	\$286
	3/4	34 1/4	28	23	3	VL35EP	\$275
	3/4	28 1/4	28	18	3	VL29EP	\$258
	3/4	22 1/4	28	14	2	VL23EP	\$236
	3/4	18 1/4	28	13	2	VL19EP	\$237



- one end panel grommet
- use to create desk or credenza using modular top and modesty panel
- see page 101 for modesty panels and pages 58-61 for selection guide
- metal attachment brackets field installed to allow for use as right or left

<b>Modular End Panel for Return Shell</b>	3/4	47 5/8	28	31	4	VL48EP	\$298
	3/4	41 5/8	28	27	4	VL42EP	\$286
	3/4	35 5/8	28	23	3	VL36EP	\$275
	3/4	29 5/8	28	19	3	VL30EP	\$258
	3/4	23 5/8	28	15	2	VL24EP	\$236
	3/4	19 5/8	28	13	2	VL20EP	\$225



- one end panel grommet
- use to create return shell using modular top and modesty panel
- see page 101 for modesty panels and pages 58-61 for selection guide
- metal attachment brackets field installed to allow for use as right or left

**To Order, Specify:**

- ① Model Number
- ② Laminate Color (see page 38)
  - a.) Chassis Color
  - b.) Drawer Color
- ③ Edge Profile (see page 43)
- ④ Pull Style and Color (see page 43)
- ⑤ Grommet Color - Matte Black (MBK) or Stardust Silver (STS) (see page 44)
- ⑥ Other Product Options (see page 39)

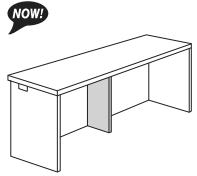
When ordering Quickship products, place a "Q" in front of model number.  
Example: QVL3072DD



**Modular**

Description	D	W	H	CTN WT	CU FT	① Model	List Price
-------------	---	---	---	-----------	----------	---------	------------

<b>Modular Center Support Panel</b>	3/4	12	28	8	1	<b>VL12SP</b>	<b>\$171</b>
-------------------------------------	-----	----	----	---	---	---------------	--------------



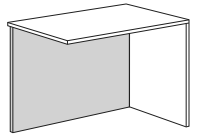
- NOW!**
- one end panel grommet
  - used for modular with an unsupported span greater than 48"
  - NOT FOR USE ON THE END OF THE UNIT. Used as additional support for center of top
  - MUST be used in conjunction with a modesty panel
  - see page 101 for modesty panels and pages 58-61 for selection guide
  - metal attachment brackets field installed

<b>Modular Shell Return Modesty Panel</b>	3/4	54 1/16	28	32	4	<b>VL2855MA</b>	<b>\$312</b>
---	-----	---------	----	----	---	-----------------	--------------

<b>Modesty Panel</b>	3/4	48 1/16	28	28	4	<b>VL2849MA</b>	<b>\$286</b>
----------------------	-----	---------	----	----	---	-----------------	--------------

<b>Modesty Panel</b>	3/4	42 1/16	28	25	3	<b>VL2843MA</b>	<b>\$255</b>
----------------------	-----	---------	----	----	---	-----------------	--------------

<b>Modesty Panel</b>	3/4	36 1/16	28	21	3	<b>VL2837MA</b>	<b>\$224</b>
----------------------	-----	---------	----	----	---	-----------------	--------------



- NOW!**
- one modesty panel grommet
  - extends 7/8" inside of connecting unit back panel
  - use with VL24EP and modular top to make shell return
  - see specification guide on pages 58-61 to determine proper size and model for your application

<b>Modular Pedestal Return Modesty Panel</b>	3/4	45 3/16	28	27	4	<b>VL2845MA</b>	<b>\$280</b>
--	-----	---------	----	----	---	-----------------	--------------

<b>Modesty Panel</b>	3/4	39 3/16	28	23	3	<b>VL2839MA</b>	<b>\$240</b>
----------------------	-----	---------	----	----	---	-----------------	--------------

<b>Modesty Panel</b>	3/4	33 3/16	28	20	3	<b>VL2833MA</b>	<b>\$212</b>
----------------------	-----	---------	----	----	---	-----------------	--------------

<b>Modesty Panel</b>	3/4	30 15/16	28	19	3	<b>VL2831MA</b>	<b>\$209</b>
----------------------	-----	----------	----	----	---	-----------------	--------------

<b>Modesty Panel</b>	3/4	27 3/16	28	16	2	<b>VL2827MA</b>	<b>\$199</b>
----------------------	-----	---------	----	----	---	-----------------	--------------

<b>Modesty Panel</b>	3/4	24 15/16	28	15	2	<b>VL2824MA</b>	<b>\$196</b>
----------------------	-----	----------	----	----	---	-----------------	--------------

<b>Modesty Panel</b>	3/4	21 3/16	28	13	2	<b>VL2821MA</b>	<b>\$195</b>
----------------------	-----	---------	----	----	---	-----------------	--------------

<b>Modesty Panel</b>	3/4	18 15/16	28	12	2	<b>VL2818MA</b>	<b>\$194</b>
----------------------	-----	----------	----	----	---	-----------------	--------------

<b>Modesty Panel</b>	3/4	12 15/16	28	8	1	<b>VL2812MA</b>	<b>\$192</b>
----------------------	-----	----------	----	---	---	-----------------	--------------

<b>Modesty Panel</b>	3/4	6 15/16	28	5	1	<b>VL2807MA</b>	<b>\$178</b>
----------------------	-----	---------	----	---	---	-----------------	--------------

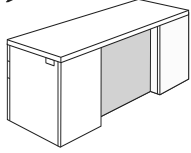


\* If desired application is not listed, contact customer service for a quote.

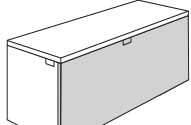
- one modesty panel grommet
- extends 7/8" inside of connecting unit back panel
- see specification guide on pages 58-61 to determine proper size and model for your application

VISION - LAMINATE

Modular

Description	D	W	H	CTN WT	CU FT	① Model	List Price
<b>Modular Break Front Desk and Credenza Modesty Panels</b> 	3/4	58 5/8	28	35	4	VL2859MA	\$331
	3/4	52 5/8	28	31	4	VL2853MA	\$312
	3/4	50 3/8	28	30	4	VL2850MA	\$302
	3/4	46 5/8	28	28	4	VL2847MA	\$286
	3/4	44 3/8	28	26	4	VL2844MA	\$255
	3/4	40 5/8	28	24	4	VL2840MA	\$247
	3/4	38 3/8	28	23	4	VL2838MA	\$242
	3/4	34 5/8	28	21	3	VL2834MA	\$222
	3/4	32 3/8	28	19	3	VL2832MA	\$219
	3/4	28 5/8	28	17	2	VL2828MA	\$199
	3/4	26 3/8	28	16	2	VL2826MA	\$198
	3/4	20 3/8	28	12	2	VL2820MA	\$195
3/4	14 3/8	28	9	2	VL2814MA	\$193	

- one modesty panel grommet
  - see specification guide on pages 58-61 to determine proper size and model for your application
- Note: If desired application is not listed contact customer service for a quote.

<b>Modular Desk and Credenza Shell Modesty Panels</b> 	3/4	59 7/8	28	35	4	VL2860MA	\$331
	3/4	53 7/8	28	32	4	VL2854MA	\$312
	3/4	47 7/8	28	28	4	VL2848MA	\$286
	3/4	41 7/8	28	25	3	VL2842MA	\$255
	3/4	35 7/8	28	21	3	VL2836MA	\$224
	3/4	29 7/8	28	18	2	VL2830MA	\$201

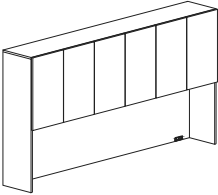
- one modesty panel grommet
  - use with two VL23EP end panels
  - use specification guide on pages 58-61 to determine proper size and model for your application
- Note: If desired application is not listed contact customer service for a quote.

To Order, Specify:

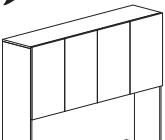
- ① Model Number
- ② Laminate Color (see page 38)
- ③ Grommet Color - Matte Black (MBK) or Stardust Silver (STS) (see page 44)
- ④ Other Product Options (see page 39)

When ordering Quickship products, place a "Q" in front of model number.  
 Example: QVL3072DD

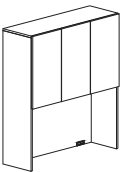


Description	D	W	H	CTN WT	CU FT	① Model	List Price
<b>Double Height Storage Overhead Cabinet with Six Doors</b> 	16	108	54	421	65	<b>VL16108DSO</b>	\$2,245
	16	102	54	398	61	<b>VL16102DSO</b>	\$2,131
	16	96	54	375	58	<b>VL1696DSO</b>	\$2,014
	16	90	54	351	54	<b>VL1690DSO</b>	\$1,907

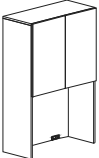
- grommets in bottom left and right and in top center of back panel
- tackboards available, see pages 116-119 or 130-133
- task lights available, see page 412
- locking doors available, specify and add \$315 list
- 25" vertical clearance from desk top to bottom of light soffit
- no pulls
- backside of unit intended to go against a wall, cabinet should be secured to a wall as a safety precaution

<b>Double Height Storage Overhead Cabinet with Four Doors</b> 	16	84	54	314	51	<b>VL1684DSO</b>	\$1,805
	16	78	54	297	47	<b>VL1678DSO</b>	\$1,709
	16	72	54	281	44	<b>VL1672DSO</b>	\$1,617
	16	66	54	265	40	<b>VL1666DSO</b>	\$1,530
	16	60	54	249	37	<b>VL1660DSO</b>	\$1,460
	16	54	54	225	33	<b>VL1654DSO</b>	\$1,386

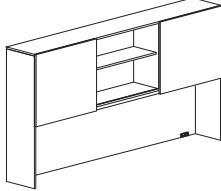
- grommets in bottom left and right and in top center of back panel
- tackboards available, see pages 116-119 or 130-133
- task lights available, see page 412
- locking doors available, specify and add \$210 list
- 25" vertical clearance from desk top to bottom of light soffit
- no pulls
- backside of unit intended to go against a wall, cabinet should be secured to a wall as a safety precaution

<b>Double Height Storage Overhead Cabinet with Three Doors</b> 	16	48	54	198	30	<b>VL1648DSOR</b>	\$1,318
	16	48	54	198	30	<b>VL1648DSOL</b>	\$1,318
	16	42	54	174	26	<b>VL1642DSOR</b>	\$1,253
	16	42	54	174	26	<b>VL1642DSOL</b>	\$1,253

- grommets in bottom left and right and in top center of back panel
- tackboards available, see pages 116-119 or 130-133
- task lights available, see page 412
- locking doors available, specify and add \$210 list
- 25" vertical clearance from desk top to bottom of light soffit
- no pulls
- backside of unit intended to go against a wall, cabinet should be secured to a wall as a safety precaution

<b>Double Height Storage Overhead Cabinet with Two Doors</b> 	16	36	54	148	23	<b>VL1636DSO</b>	\$1,191
	16	30	54	130	19	<b>VL1630DSO</b>	\$1,133

- grommets in bottom left and right and in top center of back panel
- tackboards available, see pages 116-119 or 130-133
- task lights available, see page 412
- locking doors available, specify and add \$105 list
- 25" vertical clearance from desk top to bottom of light soffit
- no pulls
- backside of unit intended to go against a wall, cabinet should be secured to a wall as a safety precaution

Description	D	W	H	CTN WT	CU FT	① Model	List Price
<b>Double Height Storage Overhead Cabinet with Two Sliding Doors</b> 	16	108	54	421	65	VL16108DSD	\$2,535
	16	102	54	398	61	VL16102DSD	\$2,410
	16	96	54	375	58	VL1696DSD	\$2,292
	16	90	54	351	54	VL1690DSD	\$2,180

**NOW!**

- grommets in bottom left and right and in top center of back panel
- tackboards available, see pages 116-119 or 130-133
- task lights available, see page 412
- 25" vertical clearance from desk top to bottom of light soffit
- white markerboard door available, specify and add \$431 list
- locking doors not available
- pulls not available
- backside of unit intended to go against a wall, cabinet should be secured to a wall as a safety precaution

<b>Double Height Storage Overhead Cabinet with Sliding Door</b> 	16	84	54	314	51	VL1684DSD	\$2,073
	16	78	54	297	47	VL1678DSD	\$1,971
	16	72	54	281	44	VL1672DSD	\$1,876
	16	66	54	265	40	VL1666DSD	\$1,783
	16	60	54	249	37	VL1660DSD	\$1,711
	16	54	54	225	33	VL1654DSD	\$1,634
	16	48	54	198	30	VL1648DSD	\$1,562
	16	42	54	174	26	VL1642DSD	\$1,496
	16	36	54	148	23	VL1636DSD	\$1,434
	16	30	54	130	19	VL1630DSD	\$1,417

**NOW!**

- grommets in bottom left and right and in top center of back panel
- tackboards available, see pages 116-119 or 130-133
- task lights available, see page 412
- 25" vertical clearance from desk top to bottom of light soffit
- white markerboard door available, specify and add \$216 list
- locking doors not available
- pulls not available
- backside of unit intended to go against a wall, cabinet should be secured to a wall as a safety precaution

**To Order, Specify:**

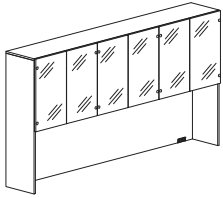
- ① Model Number
- ② Laminate Color (see page 38)
  - a.) Chassis Color
  - b.) Door Color
- ③ Grommet Color - Matte Black (MBK) or Stardust Silver (STS) (see page 44)
- ④ Other Product Options (see page 39)

When ordering Quickship products, place a "Q" in front of model number.  
 Example: QVL3072DD

**NOW!**  
*Need it.*  
 JSI Quickship



Description	D	W	H	CTN WT	CU FT	① Model	Frameless List Price	Aluminum Frame List Price
Double Height Storage Overhead Cabinet with Six Glass Doors	16	108	54	421	65	VL16108DGSO	\$2,762	\$3,826
	16	102	54	398	61	VL16102DGSO	\$2,627	\$3,674
	16	96	54	375	58	VL1696DGSO	\$2,498	\$3,527
	16	90	54	351	54	VL1690DGSO	\$2,375	\$3,386



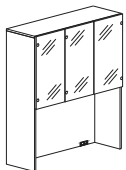
- select Frosted Frameless, Frosted with Aluminum Frame or White Back Painted with Aluminum Frame
- grommets in bottom left and right and in top center of back panel
- tackboards available, see pages 116-119 or 130-133
- task lights available, see page 412
- 25" vertical clearance from desk top to bottom of light soffit
- locking doors not available
- pulls not available
- backside of unit intended to go against a wall, cabinet should be secured to a wall as a safety precaution

Double Height Storage Overhead Cabinet with Four Glass Doors	16	84	54	314	51	VL1684DGSO	\$2,257	\$3,002
	16	78	54	297	47	VL1678DGSO	\$2,145	\$2,872
	16	72	54	281	44	VL1672DGSO	\$2,039	\$2,747
	16	66	54	265	40	VL1666DGSO	\$1,928	\$2,621
	16	60	54	249	37	VL1660DGSO	\$1,865	\$2,529
	16	54	54	225	33	VL1654DGSO	\$1,768	\$2,425



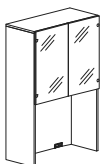
- select Frosted Frameless, Frosted with Aluminum Frame or White Back Painted with Aluminum Frame
- grommets in bottom left and right and in top center of back panel
- tackboards available, see pages 116-119 or 130-133
- task lights available, see page 412
- 25" vertical clearance from desk top to bottom of light soffit
- locking doors not available
- pulls not available
- backside of unit intended to go against a wall, cabinet should be secured to a wall as a safety precaution

Double Height Storage Overhead Cabinet with Three Glass Doors	16	48	54	198	30	VL1648DGSOR	\$1,688	\$2,203
	16	48	54	198	30	VL1648DGSOL	\$1,688	\$2,203
	16	42	54	174	26	VL1642DGSOR	\$1,611	\$2,108
	16	42	54	174	26	VL1642DGSOL	\$1,611	\$2,108

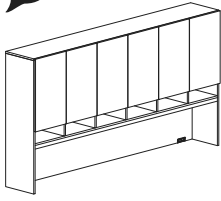


- select Frosted Frameless, Frosted with Aluminum Frame or White Back Painted with Aluminum Frame
- grommets in bottom left and right and in top center of back panel
- tackboards available, see pages 116-119 or 130-133
- task lights available, see page 412
- 25" vertical clearance from desk top to bottom of light soffit
- locking doors not available
- pulls not available
- backside of unit intended to go against a wall, cabinet should be secured to a wall as a safety precaution

Double Height Storage Overhead Cabinet with Two Glass Doors	16	36	54	148	23	VL1636DGSO	\$1,537	\$1,892
	16	30	54	130	19	VL1630DGSO	\$1,468	\$1,805

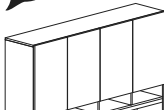


- select Frosted Frameless, Frosted with Aluminum Frame or White Back Painted with Aluminum Frame
- grommets in bottom left and right and in top center of back panel
- tackboards available, see pages 116-119 or 130-133
- task lights available, see page 412
- 25" vertical clearance from desk top to bottom of light soffit
- locking doors not available
- pulls not available
- backside of unit intended to go against a wall, cabinet should be secured to a wall as a safety precaution

Description	D	W	H	CTN WT	CU FT	① Model	List Price
<b>Double Height Storage Overhead Cabinet with Six Doors and Cubbies</b> 	16	108	54	466	65	<b>VL16108DSOC</b>	\$2,608
	16	102	54	441	61	<b>VL16102DSOC</b>	\$2,480
	16	96	54	415	58	<b>VL1696DSOC</b>	\$2,359
	16	90	54	389	54	<b>VL1690DSOC</b>	\$2,242

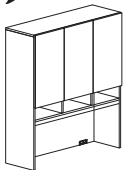
**NOW!**

- grommets in bottom left and right and in top center of back panel
- tackboards available, see pages 120-122 or 134-137
- task lights available, see page 412
- locking doors available, specify and add \$315 list
- 19" vertical clearance from desk top to bottom of light soffit
- no pulls
- backside of unit intended to go against a wall, cabinet should be secured to a wall as a safety precaution

<b>Double Height Storage Overhead Cabinet with Four Doors and Cubbies</b> 	16	84	54	349	51	<b>VL1684DSOC</b>	\$2,133
	16	78	54	330	47	<b>VL1678DSOC</b>	\$2,027
	16	72	54	311	44	<b>VL1672DSOC</b>	\$1,926
	16	66	54	293	40	<b>VL1666DSOC</b>	\$1,823
	16	60	54	274	37	<b>VL1660DSOC</b>	\$1,754
	16	54	54	248	33	<b>VL1654DSOC</b>	\$1,673

**NOW!**

- grommets in bottom left and right and in top center of back panel
- tackboards available, see pages 120-122 or 134-137
- task lights available, see page 412
- locking doors available, specify and add \$210 list
- 19" vertical clearance from desk top to bottom of light soffit
- no pulls
- backside of unit intended to go against a wall, cabinet should be secured to a wall as a safety precaution

<b>Double Height Storage Overhead Cabinet with Three Doors and Cubbies</b> 	16	48	54	218	30	<b>VL1648DSOCR</b>	\$1,596
	16	48	54	218	30	<b>VL1648DSOCL</b>	\$1,596
	16	42	54	192	26	<b>VL1642DSOCR</b>	\$1,524
	16	42	54	192	26	<b>VL1642DSOCL</b>	\$1,524

**NOW!**

- grommets in bottom left and right and in top center of back panel
- tackboards available, see pages 120-122 or 134-137
- task lights available, see page 412
- locking doors available, specify and add \$210 list
- 19" vertical clearance from desk top to bottom of light soffit
- no pulls
- backside of unit intended to go against a wall, cabinet should be secured to a wall as a safety precaution

**To Order, Specify:**

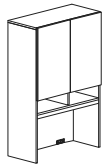
- ① Model Number
- ② Laminate Color (see page 38)
  - a.) Chassis Color
  - b.) Door Color
- ③ Glass Option/Color (see page 47)
- ④ Grommet Color - Matte Black (MBK) or Stardust Silver (STS) (see page 44)
- ⑤ Other Product Options (see page 39)

When ordering Quickship products, place a "Q" in front of model number.  
 Example: QVL3072DD

**NOW!**  
 Need it.  
 JSI Quickship

Description	D	W	H	CTN WT	CU FT	① Model	List Price
Double Height Storage Overhead Cabinet with Two Doors and Cubbies	16	36	54	163	23	VL1636DSOC	\$1,455
	16	30	54	143	19	VL1630DSOC	\$1,391

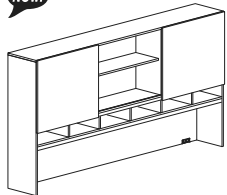
**NOW!**



- grommets in bottom left and right and in top center of back panel
- tackboards available, see pages 120-122 or 134-137
- task lights available, see page 412
- locking doors available, specify and add \$105 list
- 19" vertical clearance from desk top to bottom of light soffit
- no pulls
- backside of unit intended to go against a wall, cabinet should be secured to a wall as a safety precaution

Double Height Storage Overhead Cabinet with Two Sliding Doors and Cubbies	16	108	54	466	65	VL16108DSDC	\$2,916
	16	102	54	441	61	VL16102DSDC	\$2,785
	16	96	54	415	58	VL1696DSDC	\$2,660
	16	90	54	389	54	VL1690DSDC	\$2,541

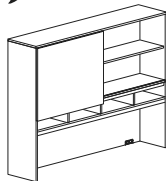
**NOW!**



- grommets in bottom left and right and in top center of back panel
- tackboards available, see pages 120-122 or 134-137
- task lights available, see page 412
- 19" vertical clearance from desk top to bottom of light soffit
- white markerboard door available, specify and add \$431 list
- locking doors not available
- pulls not available
- backside of unit intended to go against a wall, cabinet should be secured to a wall as a safety precaution

Double Height Storage Overhead Cabinet with Sliding Door and Cubbies	16	84	54	349	51	VL1684DSDC	\$2,427
	16	78	54	330	47	VL1678DSDC	\$2,319
	16	72	54	311	44	VL1672DSDC	\$2,215
	16	66	54	293	40	VL1666DSDC	\$2,105
	16	60	54	274	37	VL1660DSDC	\$2,036
	16	54	54	248	33	VL1654DSDC	\$1,955

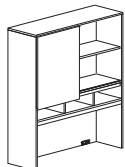
**NOW!**



- grommets in bottom left and right and in top center of back panel
- tackboards available, see pages 120-122 or 134-137
- task lights available, see page 412
- 19" vertical clearance from desk top to bottom of light soffit
- white markerboard door available, specify and add \$216 list
- locking doors not available
- pulls not available
- backside of unit intended to go against a wall, cabinet should be secured to a wall as a safety precaution

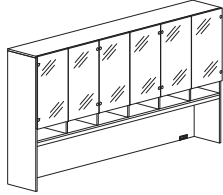
Double Height Storage Overhead Cabinet with Sliding Door and Cubbies	16	48	54	218	30	VL1648DSDC	\$1,875
	16	42	54	192	26	VL1642DSDC	\$1,803
	16	36	54	163	23	VL1636DSDC	\$1,735
	16	30	54	143	19	VL1630DSDC	\$1,724

**NOW!**



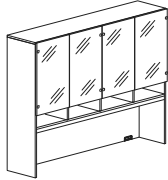
- grommets in bottom left and right and in top center of back panel
- tackboards available, see pages 120-122 or 134-137
- task lights available, see page 412
- 19" vertical clearance from desk top to bottom of light soffit
- white markerboard door available, specify and add \$216 list
- locking doors not available
- pulls not available
- backside of unit intended to go against a wall, cabinet should be secured to a wall as a safety precaution

Description	D	W	H	CTN WT	CU FT	① Model	Frameless List Price	Aluminum Frame List Price
<b>Double Height Storage Overhead Cabinet with Six Glass Doors and Cubbies</b>	16	108	54	466	65	<b>VL16108DGSOC</b>	\$3,208	\$4,272
	16	102	54	441	61	<b>VL16102DGSOC</b>	\$3,062	\$4,110
	16	96	54	415	58	<b>VL1696DGSOC</b>	\$2,926	\$3,955
	16	90	54	389	54	<b>VL1690DGSOC</b>	\$2,792	\$3,804



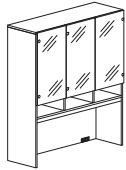
- select Frosted Frameless, Frosted with Aluminum Frame or White Back Painted with Aluminum Frame
- grommets in bottom left and right and in top center of back panel
- tackboards available, see pages 120-122 or 134-137
- task lights available, see page 412
- 19" vertical clearance from desk top to bottom of light soffit
- locking doors not available
- pulls not available
- backside of unit intended to go against a wall, cabinet should be secured to a wall as a safety precaution

<b>Double Height Storage Overhead Cabinet with Four Glass Doors and Cubbies</b>	16	84	54	349	51	<b>VL1684DGSOC</b>	\$2,666	\$3,412
	16	78	54	330	47	<b>VL1678DGSOC</b>	\$2,545	\$3,272
	16	72	54	311	44	<b>VL1672DGSOC</b>	\$2,427	\$3,136
	16	66	54	293	40	<b>VL1666DGSOC</b>	\$2,298	\$2,991
	16	60	54	274	37	<b>VL1660DGSOC</b>	\$2,228	\$2,902
	16	54	54	248	33	<b>VL1654DGSOC</b>	\$2,134	\$2,791



- select Frosted Frameless, Frosted with Aluminum Frame or White Back Painted with Aluminum Frame
- grommets in bottom left and right and in top center of back panel
- tackboards available, see pages 120-122 or 134-137
- task lights available, see page 412
- 19" vertical clearance from desk top to bottom of light soffit
- locking doors not available
- pulls not available
- backside of unit intended to go against a wall, cabinet should be secured to a wall as a safety precaution

<b>Double Height Storage Overhead Cabinet with Three Glass Doors and Cubbies</b>	16	48	54	218	30	<b>VL1648DGSOCR</b>	\$2,044	\$2,559
	16	48	54	218	30	<b>VL1648DGSOCL</b>	\$2,044	\$2,559
	16	42	54	192	26	<b>VL1642DGSOCR</b>	\$1,959	\$2,455
	16	42	54	192	26	<b>VL1642DGSOCL</b>	\$1,959	\$2,455



- select Frosted Frameless, Frosted with Aluminum Frame or White Back Painted with Aluminum Frame
- grommets in bottom left and right and in top center of back panel
- tackboards available, see pages 120-122 or 134-137
- task lights available, see page 412
- 19" vertical clearance from desk top to bottom of light soffit
- locking doors not available
- pulls not available
- backside of unit intended to go against a wall, cabinet should be secured to a wall as a safety precaution

### To Order, Specify:

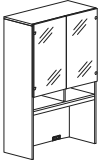
- ① Model Number
- ② Laminate Color (see page 38)
  - a.) Chassis Color
  - b.) Door Color
- ③ Glass Option/Color (see page 47)
- ④ Grommet Color - Matte Black (MBK) or Stardust Silver (STS) (see page 44)
- ⑤ Other Product Options (see page 39)

When ordering Quickship products, place a "Q" in front of model number.  
Example: QVL3072DD

**NOW!**  
Need it.  
JSI Quickship

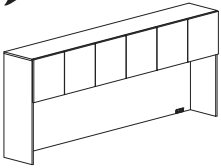
Description	D	W	H	CTN WT	CU FT	Model	Frameless List Price	Aluminum Frame List Price
Double Height Storage Overhead Cabinet with Two Glass Doors and Cubbies	16	36	54	163	23	VL1636DGSOC	\$1,877	\$2,232
	16	30	54	143	19	VL1630DGSOC	\$1,801	\$2,138

- select Frosted Frameless, Frosted with Aluminum Frame or White Back Painted with Aluminum Frame
- grommets in bottom left and right and in top center of back panel
- tackboards available, see pages 120-122 or 134-137
- task lights available, see page 412
- 19" vertical clearance from desk top to bottom of light soffit
- locking doors not available
- pulls not available
- backside of unit intended to go against a wall, cabinet should be secured to a wall as a safety precaution



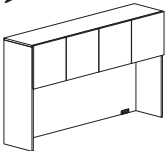
							List Price
Storage Overhead Cabinet with Six Doors	16	108	42	327	51	VL16108SO	\$1,825
	16	102	42	309	48	VL16102SO	\$1,721
	16	96	42	291	45	VL1696SO	\$1,624
	16	90	42	273	43	VL1690SO	\$1,531

- grommets in bottom left and right and in top center of back panel
- tackboards available, see pages 116-119 or 130-133
- task lights available, see page 412
- locking doors available, specify and add \$315 list
- 25" vertical clearance from desk top to bottom of light soffit
- no pulls



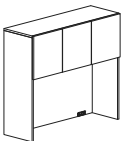
Storage Overhead Cabinet with Four Doors	16	84	42	244	40	VL1684SO	\$1,444
	16	78	42	231	37	VL1678SO	\$1,361
	16	72	42	218	34	VL1672SO	\$1,284
	16	66	42	206	32	VL1666SO	\$1,214
	16	60	42	193	29	VL1660SO	\$1,149
	16	54	42	175	26	VL1654SO	\$1,087

- grommets in bottom left and right and in top center of back panel
- tackboards available, see pages 116-119 or 130-133
- task lights available, see page 412
- locking doors available, specify and add \$210 list
- 25" vertical clearance from desk top to bottom of light soffit
- no pulls



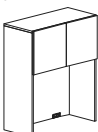
Storage Overhead Cabinet with Three Doors	16	48	42	154	23	VL1648SOR	\$1,029
	16	48	42	154	23	VL1648SOL	\$1,029
	16	42	42	135	21	VL1642SOR	\$975
	16	42	42	135	21	VL1642SOL	\$975

- grommets in bottom left and right and in top center of back panel
- tackboards available, see pages 116-119 or 130-133
- task lights available, see page 412
- locking doors available, specify and add \$210 list
- 25" vertical clearance from desk top to bottom of light soffit
- no pulls

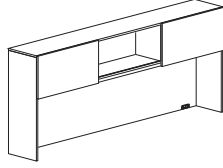


Storage Overhead Cabinet with Two Doors	16	36	42	115	18	VL1636SO	\$923
	16	30	42	101	15	VL1630SO	\$875

- grommets in bottom left and right and in top center of back panel
- tackboards available, see pages 116-119 or 130-133
- task lights available, see page 412
- locking doors available, specify and add \$105 list
- 25" vertical clearance from desk top to bottom of light soffit
- no pulls

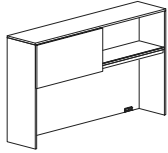


Description	D	W	H	CTN WT	CU FT	① Model	List Price
Storage Overhead Cabinet with Two Sliding Doors <b>NOW!</b>	16	108	42	327	51	VL16108SD	\$2,112
	16	102	42	309	48	VL16102SD	\$2,000
	16	96	42	291	45	VL1696SD	\$1,894
	16	90	42	273	43	VL1690SD	\$1,794



- grommets in bottom left and right and in top center of back panel
- tackboards available, see pages 116-119 or 130-133
- task lights available, see page 412
- 25" vertical clearance from desk top to bottom of light soffit
- white markerboard door available, specify and add \$326 list
- locking doors not available
- pulls not available

Storage Overhead Cabinet with Sliding Door <b>NOW!</b>	16	84	42	244	40	VL1684SD	\$1,699
	16	78	42	231	37	VL1678SD	\$1,609
	16	72	42	218	34	VL1672SD	\$1,525
	16	66	42	206	32	VL1666SD	\$1,449
	16	60	42	193	29	VL1660SD	\$1,379
	16	54	42	175	26	VL1654SD	\$1,312
	16	48	42	154	23	VL1648SD	\$1,249
	16	42	42	135	21	VL1642SD	\$1,191
	16	36	42	115	18	VL1636SD	\$1,138
	16	30	42	101	15	VL1630SD	\$1,120



- grommets in bottom left and right and in top center of back panel
- tackboards available, see pages 116-119 or 130-133
- task lights available, see page 412
- 25" vertical clearance from desk top to bottom of light soffit
- white markerboard door available, specify and add \$163 list
- locking doors not available
- pulls not available

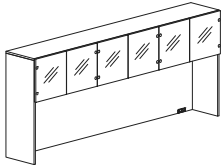
**To Order, Specify:**

- ① Model Number
- ② Laminate Color (see page 38)
  - a.) Chassis Color
  - b.) Door Color
- ③ Glass Option/Color (see page 47)
- ④ Grommet Color - Matte Black (MBK) or Stardust Silver (STS) (see page 44)
- ⑤ Other Product Options (see page 39)

When ordering Quickship products, place a "Q" in front of model number.  
Example: QVL3072DD

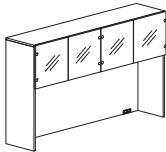


Description	D	W	H	CTN WT	CU FT	① Model	Frameless List Price	Aluminum Frame List Price
Storage Overhead Cabinet with Six Glass Doors	16	108	42	327	51	VL16108GSO	\$2,191	\$3,063
	16	102	42	309	48	VL16102GSO	\$2,074	\$2,934
	16	96	42	291	45	VL1696GSO	\$1,965	\$2,805
	16	90	42	273	43	VL1690GSO	\$1,861	\$2,686



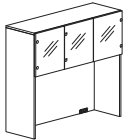
- select Frosted Frameless, Frosted with Aluminum Frame or White Back Painted with Aluminum Frame
- grommets in bottom left and right and in top center of back panel
- tackboards available, see pages 116-119 or 130-133
- task lights available, see page 412
- 25" vertical clearance from desk top to bottom of light soffit
- locking doors not available
- pulls not available

Storage Overhead Cabinet with Four Glass Doors	16	84	42	244	40	VL1684GSO	\$1,762	\$2,379
	16	78	42	231	37	VL1678GSO	\$1,668	\$2,256
	16	72	42	218	34	VL1672GSO	\$1,580	\$2,161
	16	66	42	206	32	VL1666GSO	\$1,494	\$2,061
	16	60	42	193	29	VL1660GSO	\$1,425	\$1,976
	16	54	42	175	26	VL1654GSO	\$1,354	\$1,889



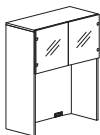
- select Frosted Frameless, Frosted with Aluminum Frame or White Back Painted with Aluminum Frame
- grommets in bottom left and right and in top center of back panel
- tackboards available, see pages 116-119 or 130-133
- task lights available, see page 412
- 25" vertical clearance from desk top to bottom of light soffit
- locking doors not available
- pulls not available

Storage Overhead Cabinet with Three Glass Doors	16	48	42	154	23	VL1648GSOR	\$1,287	\$1,708
	16	48	42	154	23	VL1648GSOL	\$1,287	\$1,708
	16	42	42	135	21	VL1642GSOR	\$1,224	\$1,626
	16	42	42	135	21	VL1642GSOL	\$1,224	\$1,626

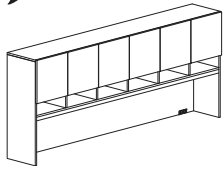


- select Frosted Frameless, Frosted with Aluminum Frame or White Back Painted with Aluminum Frame
- grommets in bottom left and right and in top center of back panel
- tackboards available, see pages 116-119 or 130-133
- task lights available, see page 412
- 25" vertical clearance from desk top to bottom of light soffit
- locking doors not available
- pulls not available

Storage Overhead Cabinet with Two Glass Doors	16	36	42	115	18	VL1636GSO	\$1,164	\$1,456
	16	30	42	101	15	VL1630GSO	\$1,107	\$1,383



- select Frosted Frameless, Frosted with Aluminum Frame or White Back Painted with Aluminum Frame
- grommets in bottom left and right and in top center of back panel
- tackboards available, see pages 116-119 or 130-133
- task lights available, see page 412
- 25" vertical clearance from desk top to bottom of light soffit
- locking doors not available
- pulls not available

Description	D	W	H	CTN WT	CU FT	① Model	List Price
<b>Storage Overhead Cabinet with Six Doors and Cubbies</b> 	16	108	42	372	51	VL16108SOC	\$2,173
	16	102	42	352	48	VL16102SOC	\$2,057
	16	96	42	331	45	VL1696SOC	\$1,949
	16	90	42	311	43	VL1690SOC	\$1,845

- grommets in bottom left and right and in top center of back panel
- tackboards available, see pages 120-122 or 134-137
- task lights available, see page 412
- locking doors available, specify and add \$315 list
- 19" vertical clearance from desk top to bottom of light soffit
- no pulls

<b>Storage Overhead Cabinet with Four Doors and Cubbies</b> 	16	84	42	279	40	VL1684SOC	\$1,748
	16	78	42	264	37	VL1678SOC	\$1,654
	16	72	42	248	34	VL1672SOC	\$1,566
	16	66	42	234	32	VL1666SOC	\$1,482
	16	60	42	218	29	VL1660SOC	\$1,414
	16	54	42	198	26	VL1654SOC	\$1,343

- grommets in bottom left and right and in top center of back panel
- tackboards available, see pages 120-122 or 134-137
- task lights available, see page 412
- locking doors available, specify and add \$210 list
- 19" vertical clearance from desk top to bottom of light soffit
- no pulls

<b>Storage Overhead Cabinet with Three Doors and Cubbies</b> 	16	48	42	174	23	VL1648SOCL	\$1,277
	16	48	42	174	23	VL1648SOCL	\$1,277
	16	42	42	153	21	VL1642SOCL	\$1,214
	16	42	42	153	21	VL1642SOCL	\$1,214

- grommets in bottom left and right and in top center of back panel
- tackboards available, see pages 120-122 or 134-137
- task lights available, see page 412
- locking doors available, specify and add \$210 list
- 19" vertical clearance from desk top to bottom of light soffit
- no pulls

**To Order, Specify:**

- ① Model Number
- ② Laminate Color (see page 38)
  - a.) Chassis Color
  - b.) Door Color
- ③ Glass Option/Color (see page 47)
- ④ Grommet Color - Matte Black (MBK) or Stardust Silver (STS) (see page 44)
- ⑤ Other Product Options (see page 39)

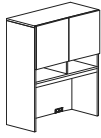
When ordering Quickship products, place a "Q" in front of model number.  
Example: QVL3072DD





Description	D	W	H	CTN WT	CU FT	Model	List Price
Storage Overhead Cabinet with Two Doors and Cubbies	16	36	42	130	18	VL1636SOC	\$1,154
	16	30	42	114	15	VL1630SOC	\$1,099

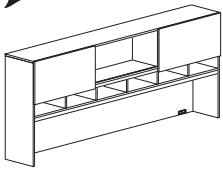
**NOW!**



- grommets in bottom left and right and in top center of back panel
- tackboards available, see pages 120-122 or 134-137
- task lights available, see page 412
- locking doors available, specify and add \$105 list
- 19" vertical clearance from desk top to bottom of light soffit
- no pulls

Storage Overhead Cabinet with Two Sliding Doors and Cubbies	16	108	42	372	51	VL16108SDC	\$2,492
	16	102	42	352	48	VL16102SDC	\$2,370
	16	96	42	331	45	VL1696SDC	\$2,254
	16	90	42	311	43	VL1690SDC	\$2,145

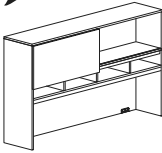
**NOW!**



- grommets in bottom left and right and in top center of back panel
- tackboards available, see pages 120-122 or 134-137
- task lights available, see page 412
- 19" vertical clearance from desk top to bottom of light soffit
- white markerboard door available, specify and add \$326 list
- locking doors not available
- pulls not available

Storage Overhead Cabinet with Sliding Door and Cubbies	16	84	42	279	40	VL1684SDC	\$2,040
	16	78	42	264	37	VL1678SDC	\$1,940
	16	72	42	248	34	VL1672SDC	\$1,845
	16	66	42	234	32	VL1666SDC	\$1,754
	16	60	42	218	29	VL1660SDC	\$1,683
	16	54	42	198	26	VL1654SDC	\$1,608

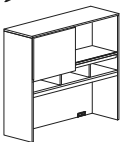
**NOW!**



- grommets in bottom left and right and in top center of back panel
- tackboards available, see pages 120-122 or 134-137
- task lights available, see page 412
- 19" vertical clearance from desk top to bottom of light soffit
- white markerboard door available, specify and add \$163 list
- locking doors not available
- pulls not available

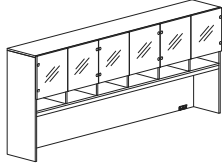
Storage Overhead Cabinet with Sliding Door and Cubbies	16	48	42	174	23	VL1648SDC	\$1,537
	16	42	42	153	21	VL1642SDC	\$1,472
	16	36	42	130	18	VL1636SDC	\$1,411
	16	30	42	114	15	VL1630SDC	\$1,395

**NOW!**



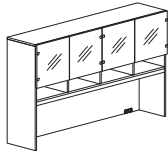
- grommets in bottom left and right and in top center of back panel
- tackboards available, see pages 120-122 or 134-137
- task lights available, see page 412
- 19" vertical clearance from desk top to bottom of light soffit
- white markerboard door available, specify and add \$163 list
- locking doors not available
- pulls not available

Description	D	W	H	CTN WT	CU FT	① Model	Frameless List Price	Aluminum Frame List Price
Storage Overhead Cabinet with Six Glass Doors and Cubbies	16	108	42	372	51	VL16108GSOC	\$2,608	\$3,480
	16	102	42	352	48	VL16102GSOC	\$2,480	\$3,339
	16	96	42	331	45	VL1696GSOC	\$2,359	\$3,199
	16	90	42	311	43	VL1690GSOC	\$2,242	\$3,068



- select Frosted Frameless, Frosted with Aluminum Frame or White Back Painted with Aluminum Frame
- grommets in bottom left and right and in top center of back panel
- tackboards available, see pages 120-122 or 134-137
- task lights available, see page 412
- 19" vertical clearance from desk top to bottom of light soffit
- locking doors not available
- pulls not available

Storage Overhead Cabinet with Four Glass Doors and Cubbies	16	84	42	279	40	VL1684GSOC	\$2,133	\$2,749
	16	78	42	264	37	VL1678GSOC	\$2,027	\$2,615
	16	72	42	248	34	VL1672GSOC	\$1,926	\$2,508
	16	66	42	234	32	VL1666GSOC	\$1,823	\$2,390
	16	60	42	218	29	VL1660GSOC	\$1,754	\$2,304
	16	54	42	198	26	VL1654GSOC	\$1,673	\$2,209



- select Frosted Frameless, Frosted with Aluminum Frame or White Back Painted with Aluminum Frame
- grommets in bottom left and right and in top center of back panel
- tackboards available, see pages 120-122 or 134-137
- task lights available, see page 412
- 19" vertical clearance from desk top to bottom of light soffit
- locking doors not available
- pulls not available

Storage Overhead Cabinet with Three Glass Doors and Cubbies	16	48	42	174	23	VL1648GSOCR	\$1,596	\$2,018
	16	48	42	174	23	VL1648GSOCL	\$1,596	\$2,018
	16	42	42	153	21	VL1642GSOCR	\$1,524	\$1,926
	16	42	42	153	21	VL1642GSOCL	\$1,524	\$1,926



- select Frosted Frameless, Frosted with Aluminum Frame or White Back Painted with Aluminum Frame
- grommets in bottom left and right and in top center of back panel
- tackboards available, see pages 120-122 or 134-137
- task lights available, see page 412
- 19" vertical clearance from desk top to bottom of light soffit
- locking doors not available
- pulls not available

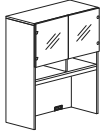
**To Order, Specify:**

- ① Model Number
- ② Laminate Color (see page 38)
  - a.) Chassis Color
  - b.) Door Color
- ③ Glass Option/Color (see page 47)
- ④ Grommet Color - Matte Black (MBK) or Stardust Silver (STS) (see page 44)
- ⑤ Other Product Options (see page 39)

When ordering Quickship products, place a "Q" in front of model number.  
Example: QVL3072DD

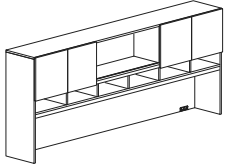


Description	D	W	H	CTN WT	CU FT	① Model	Frameless List Price	Aluminum Frame List Price
Storage Overhead Cabinet with Two Glass Doors and Cubbies	16	36	42	130	18	VL1636GSOC	\$1,455	\$1,747
	16	30	42	114	15	VL1630GSOC	\$1,391	\$1,667



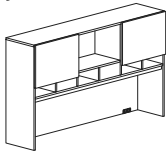
- select Frosted Frameless, Frosted with Aluminum Frame or White Back Painted with Aluminum Frame
- grommets in bottom left and right and in top center of back panel
- tackboards available, see pages 120-122 or 134-137
- task lights available, see page 412
- 19" vertical clearance from desk top to bottom of light soffit
- locking doors not available
- pulls not available

							List Price
Storage Overhead Cabinet with Four Doors, Open Center Shelf and Cubbies	16	108	42	317	51	VL16108SMOC	\$2,111
	16	102	42	299	48	VL16102SMOC	\$1,995
	16	96	42	281	45	VL1696SMOC	\$1,887
	16	90	42	263	43	VL1690SMOC	\$1,783



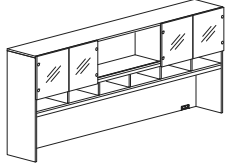
- grommets in bottom left and right and in top center of back panel
- tackboards available, see pages 120-122 or 134-137
- task lights available, see page 412
- locking doors available, specify and add \$210 list
- 19" vertical clearance from desk top to bottom of light soffit
- no pulls

Storage Overhead Cabinet with Two Doors, Open Center Shelf and Cubbies	16	84	42	234	40	VL1684SMOC	\$1,686
	16	78	42	221	37	VL1678SMOC	\$1,592
	16	72	42	208	34	VL1672SMOC	\$1,504
	16	66	42	196	32	VL1666SMOC	\$1,420
	16	60	42	183	29	VL1660SMOC	\$1,352
	16	54	42	165	26	VL1654SMOC	\$1,281



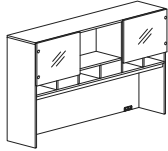
- grommets in bottom left and right and in top center of back panel
- tackboards available, see pages 120-122 or 134-137
- task lights available, see page 412
- locking doors available, specify and add \$210 list
- 19" vertical clearance from desk top to bottom of light soffit
- no pulls

Description	D	W	H	CTN WT	CU FT	① Model	Frameless List Price	Aluminum Frame List Price
Storage Overhead Cabinet with Four Glass Doors, Open Center Shelf and Cubbies	16	108	42	317	51	VL16108GSMOC	\$2,546	\$3,132
	16	102	42	299	48	VL16102GSMOC	\$2,418	\$2,994
	16	96	42	281	45	VL1696GSMOC	\$2,297	\$2,861
	16	90	42	263	43	VL1690GSMOC	\$2,180	\$2,735



- select Frosted Frameless, Frosted with Aluminum Frame or White Back Painted with Aluminum Frame
- grommets in bottom left and right and in top center of back panel
- tackboards available, see pages 120-122 or 134-137
- task lights available, see page 412
- 19" vertical clearance from desk top to bottom of light soffit
- locking doors not available
- pulls not available

Storage Overhead Cabinet with Two Glass Doors, Open Center Shelf and Cubbies	16	84	42	234	40	VL1684GSMOC	\$2,071	\$2,380
	16	78	42	221	37	VL1678GSMOC	\$1,965	\$2,260
	16	72	42	208	34	VL1672GSMOC	\$1,864	\$2,156
	16	66	42	196	32	VL1666GSMOC	\$1,761	\$2,045
	16	60	42	183	29	VL1660GSMOC	\$1,692	\$1,968
	16	54	42	165	26	VL1654GSMOC	\$1,611	\$1,879



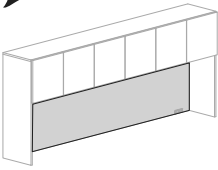
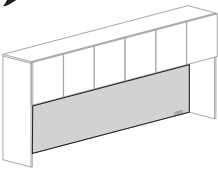
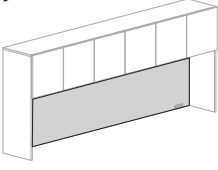
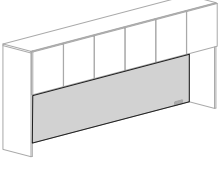
- select Frosted Frameless, Frosted with Aluminum Frame or White Back Painted with Aluminum Frame
- grommets in bottom left and right and in top center of back panel
- tackboards available, see pages 120-122 or 134-137
- task lights available, see page 412
- 19" vertical clearance from desk top to bottom of light soffit
- locking doors not available
- pulls not available

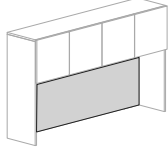
**To Order, Specify:**

- ① Model Number
- ② Laminate Color (see page 38)
  - a.) Chassis Color
  - b.) Door Color
- ③ Glass Option/Color (see page 47)
- ④ Grommet Color - Matte Black (MBK) or Stardust Silver (STS) (see page 44)
- ⑤ Other Product Options (see page 39)

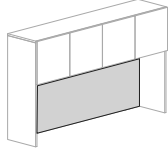
When ordering Quickship products, place a "Q" in front of model number.  
Example: QVL3072DD



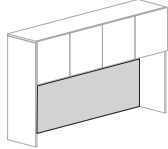
Description	D	W	H	CTN WT	CU FT	① Model	List Price Per Grade
<b>Tackboard for Front of 108" w Storage Overhead Cabinet</b>  <ul style="list-style-type: none"> <li>· for use with 108" overhead</li> <li>· Culp Montgomery Sterling panel fabric standard, use Grade A pricing</li> <li>· other fabrics available, contact customer service</li> <li>· attaches with covered button screws</li> <li>· ships attached when ordered with overhead cabinets</li> <li>· com ydg: 3 1/4</li> </ul>	3/8	106 1/8	19	14	9	VS108TK	COM \$356
							A \$389
							B \$452
							C \$563
							D \$706
							E \$850
							F \$1,071
							G \$1,310
							H \$1,564
							I \$1,961
J \$2,438							
<b>Tackboard for Front of 102" w Storage Overhead Cabinet</b>  <ul style="list-style-type: none"> <li>· for use with 102" overhead</li> <li>· Culp Montgomery Sterling panel fabric standard, use Grade A pricing</li> <li>· other fabrics available, contact customer service</li> <li>· attaches with covered button screws</li> <li>· ships attached when ordered with overhead cabinets</li> <li>· com ydg: 3 1/4</li> </ul>	3/8	100 1/8	19	13	9	VS102TK	COM \$354
							A \$387
							B \$450
							C \$561
							D \$704
							E \$848
							F \$1,069
							G \$1,308
							H \$1,562
							I \$1,959
J \$2,435							
<b>Tackboard for Front of 96" w Storage Overhead Cabinet</b>  <ul style="list-style-type: none"> <li>· for use with 96" overhead</li> <li>· Culp Montgomery Sterling panel fabric standard, use Grade A pricing</li> <li>· other fabrics available, contact customer service</li> <li>· attaches with covered button screws</li> <li>· ships attached when ordered with overhead cabinets</li> <li>· com ydg: 3</li> </ul>	3/8	94 1/8	19	12	8	VS96TK	COM \$340
							A \$370
							B \$428
							C \$531
							D \$663
							E \$794
							F \$1,000
							G \$1,220
							H \$1,455
							I \$1,821
J \$2,261							
<b>Tackboard for Front of 90" w Storage Overhead Cabinet</b>  <ul style="list-style-type: none"> <li>· for use with 90" overhead</li> <li>· Culp Montgomery Sterling panel fabric standard, use Grade A pricing</li> <li>· other fabrics available, contact customer service</li> <li>· attaches with covered button screws</li> <li>· ships attached when ordered with overhead cabinets</li> <li>· com ydg: 3</li> </ul>	3/8	88 1/8	19	11	8	VS90TK	COM \$336
							A \$367
							B \$425
							C \$528
							D \$660
							E \$791
							F \$997
							G \$1,216
							H \$1,452
							I \$1,818
J \$2,258							

Description	D	W	H	CTN WT	CU FT	① Model	List Price Per Grade
<b>Tackboard for Front of 84" w Storage Overhead Cabinet</b> 	3/8	82 1/8	19	10	7	VS84TK	COM \$294
							A \$322
							B \$375
							C \$470
							D \$591
							E \$711
							F \$900
							G \$1,102
							H \$1,316
							I \$1,652
							J \$2,055

- for use with 84" overhead
- Culp Montgomery Sterling panel fabric standard, use Grade A pricing
- other fabrics available, contact customer service
- attaches with covered button screws
- ships attached when ordered with overhead cabinets
- com ydg: 2 3/4

<b>Tackboard for Front of 78" w Storage Overhead Cabinet</b> 	3/8	76 1/8	19	9	7	VS78TK	COM \$290
							A \$315
							B \$364
							C \$450
							D \$560
							E \$669
							F \$840
							G \$1,024
							H \$1,220
							I \$1,525
							J \$1,892

- for use with 78" overhead
- Culp Montgomery Sterling panel fabric standard, use Grade A pricing
- other fabrics available, contact customer service
- attaches with covered button screws
- ships attached when ordered with overhead cabinets
- com ydg: 2 1/2

<b>Tackboard for Front of 72" w Storage Overhead Cabinet</b> 	3/8	70 1/8	19	8	6	VS72TK	COM \$272
							A \$296
							B \$339
							C \$416
							D \$515
							E \$614
							F \$768
							G \$933
							H \$1,108
							I \$1,383
							J \$1,713

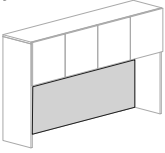
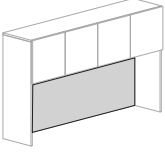
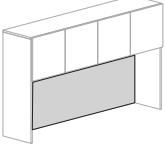
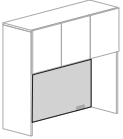
- for use with 72" overhead
- Culp Montgomery Sterling panel fabric standard, use Grade A pricing
- other fabrics available, contact customer service
- attaches with covered button screws
- ships attached when ordered with overhead cabinets
- com ydg: 2 1/4

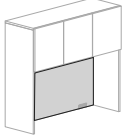

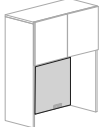

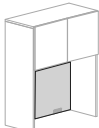

**To Order, Specify:**

- ① Model Number
- ② Fabric Selection: vendor, pattern, color

When ordering Quickship products, place a "Q" in front of model number.  
Example: QVL3072DD

**NOW!**  
Need it.  
JSI Quickship

Description	D	W	H	CTN WT	CU FT	① Model	List Price Per Grade
<b>Tackboard for Front of 66" w Storage Overhead Cabinet</b>  <p><b>NOW!</b></p> <ul style="list-style-type: none"> <li>· for use with 66" overhead</li> <li>· Culp Montgomery Sterling panel fabric standard, use Grade A pricing</li> <li>· other fabrics available, contact customer service</li> <li>· attaches with covered button screws</li> <li>· ships attached when ordered with overhead cabinets</li> <li>· com ydg: 2</li> </ul>	$\frac{3}{8}$	64 $\frac{1}{8}$	19	8	6	<b>VS66TK</b>	<b>COM</b> \$255
	A	\$275					
	B	\$313					
	C	\$383					
	D	\$470					
	E	\$558					
	F	\$695					
	G	\$842					
	H	\$998					
	I	\$1,243					
J	\$1,536						
<b>Tackboard for Front of 60" w Storage Overhead Cabinet</b>  <p><b>NOW!</b></p> <ul style="list-style-type: none"> <li>· for use with 60" overhead</li> <li>· Culp Montgomery Sterling panel fabric standard, use Grade A pricing</li> <li>· other fabrics available, contact customer service</li> <li>· attaches with covered button screws</li> <li>· ships attached when ordered with overhead cabinets</li> <li>· com ydg: 2</li> </ul>	$\frac{3}{8}$	58 $\frac{1}{8}$	19	7	5	<b>VS60TK</b>	<b>COM</b> \$249
	A	\$269					
	B	\$308					
	C	\$377					
	D	\$465					
	E	\$553					
	F	\$689					
	G	\$836					
	H	\$993					
	I	\$1,237					
J	\$1,530						
<b>Tackboard for Front of 54" w Storage Overhead Cabinet</b>  <p><b>NOW!</b></p> <ul style="list-style-type: none"> <li>· for use with 54" overhead</li> <li>· Culp Montgomery Sterling panel fabric standard, use Grade A pricing</li> <li>· other fabrics available, contact customer service</li> <li>· attaches with covered button screws</li> <li>· ships attached when ordered with overhead cabinets</li> <li>· com ydg: 1 <math>\frac{3}{4}</math></li> </ul>	$\frac{3}{8}$	52 $\frac{1}{8}$	19	7	5	<b>VS54TK</b>	<b>COM</b> \$231
	A	\$249					
	B	\$283					
	C	\$343					
	D	\$420					
	E	\$497					
	F	\$617					
	G	\$745					
	H	\$882					
	I	\$1,096					
J	\$1,352						
<b>Tackboard for Front of 48" w Storage Overhead Cabinet</b>  <p><b>NOW!</b></p> <ul style="list-style-type: none"> <li>· for use with 48" overhead</li> <li>· Culp Montgomery Sterling panel fabric standard, use Grade A pricing</li> <li>· other fabrics available, contact customer service</li> <li>· attaches with covered button screws</li> <li>· ships attached when ordered with overhead cabinets</li> <li>· com ydg: 1 <math>\frac{3}{4}</math></li> </ul>	$\frac{3}{8}$	46 $\frac{1}{8}$	19	7	4	<b>VS48TK</b>	<b>COM</b> \$227
	A	\$245					
	B	\$279					
	C	\$339					
	D	\$416					
	E	\$493					
	F	\$613					
	G	\$741					
	H	\$878					
	I	\$1,091					
J	\$1,348						

Description	D	W	H	CTN WT	CU FT	① Model	List Price Per Grade	
<b>Tackboard for Front of 42" w Storage Overhead Cabinet</b> 	3/8	40 1/8	19	6	4	VS42TK	COM \$209	
							A \$225	
							B \$254	
							C \$305	
							D \$371	
							E \$437	
							F \$540	
							G \$649	
							H \$767	
							I \$951	
J \$1,170								
 · for use with 42" overhead · Culp Montgomery Sterling panel fabric standard, use Grade A pricing · other fabrics available, contact customer service · attaches with covered button screws · ships attached when ordered with overhead cabinets · com ydg: 1 1/2								
	<b>Tackboard for Front of 36" w Storage Overhead Cabinet</b> 	3/8	34 1/8	19	5	3	VS36TK	COM \$188
								A \$201
								B \$225
								C \$268
								D \$324
								E \$378
								F \$464
								G \$556
								H \$654
I \$806								
J \$990								
 · for use with 36" overhead · Culp Montgomery Sterling panel fabric standard, use Grade A pricing · other fabrics available, contact customer service · attaches with covered button screws · ships attached when ordered with overhead cabinets · com ydg: 1 1/4								
	<b>Tackboard for Front of 30" w Storage Overhead Cabinet</b> 	3/8	28 1/8	19	5	2	VS30TK	COM \$168
								A \$181
								B \$205
								C \$248
								D \$304
								E \$359
								F \$444
								G \$536
								H \$634
I \$786								
J \$970								
 · for use with 30" overhead · Culp Montgomery Sterling panel fabric standard, use Grade A pricing · other fabrics available, contact customer service · attaches with covered button screws · ships attached when ordered with overhead cabinets · com ydg: 1 1/4								

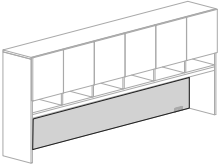
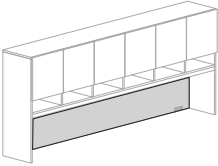
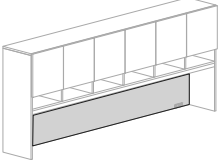
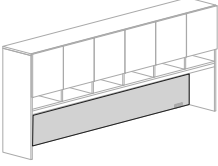
**To Order, Specify:**

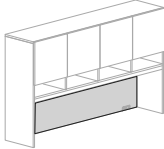
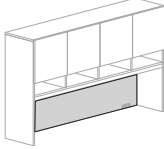
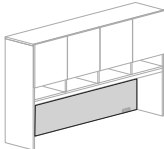
- ① Model Number
- ② Fabric Selection: vendor, pattern, color

When ordering Quickship products, place a "Q" in front of model number.  
 Example: QVL3072DD

**NOW!**  
*Need it.*  
 JSI Quickship



Description	D	W	H	CTN WT	CU FT	① Model	List Price Per Grade						
<b>Tackboard for Front of 108" w Storage Overhead Cabinet with Cubbies</b> 	3/8	106 1/8	13	14	9	VS108TKC	COM \$356						
							A \$389						
							B \$452						
							C \$563						
							D \$706						
							E \$850						
							F \$1,071						
							G \$1,310						
							H \$1,564						
							I \$1,961						
							J \$2,438						
							<ul style="list-style-type: none"> <li>· for use with 108" overhead</li> <li>· Culp Montgomery Sterling panel fabric standard, use Grade A pricing</li> <li>· other fabrics available, contact customer service</li> <li>· attaches with covered button screws</li> <li>· ships attached when ordered with overhead cabinets</li> <li>· com ydg: 3 1/4</li> </ul>						
							<b>Tackboard for Front of 102" w Storage Overhead Cabinet with Cubbies</b> 	3/8	100 1/8	13	13	9	VS102TKC
A \$387													
B \$450													
C \$561													
D \$704													
E \$848													
F \$1,069													
G \$1,308													
H \$1,562													
I \$1,959													
J \$2,435													
<ul style="list-style-type: none"> <li>· for use with 102" overhead</li> <li>· Culp Montgomery Sterling panel fabric standard, use Grade A pricing</li> <li>· other fabrics available, contact customer service</li> <li>· attaches with covered button screws</li> <li>· ships attached when ordered with overhead cabinets</li> <li>· com ydg: 3 1/4</li> </ul>													
<b>Tackboard for Front of 96" w Storage Overhead Cabinet with Cubbies</b> 	3/8	94 1/8	13	12	8	VS96TKC							
							A \$370						
							B \$428						
							C \$531						
							D \$663						
							E \$794						
							F \$1,000						
							G \$1,220						
							H \$1,455						
							I \$1,821						
							J \$2,261						
							<ul style="list-style-type: none"> <li>· for use with 96" overhead</li> <li>· Culp Montgomery Sterling panel fabric standard, use Grade A pricing</li> <li>· other fabrics available, contact customer service</li> <li>· attaches with covered button screws</li> <li>· ships attached when ordered with overhead cabinets</li> <li>· com ydg: 3</li> </ul>						
							<b>Tackboard for Front of 90" w Storage Overhead Cabinet with Cubbies</b> 	3/8	88 1/8	13	11	8	VS90TKC
A \$367													
B \$425													
C \$528													
D \$660													
E \$791													
F \$997													
G \$1,216													
H \$1,452													
I \$1,818													
J \$2,258													
<ul style="list-style-type: none"> <li>· for use with 90" overhead</li> <li>· Culp Montgomery Sterling panel fabric standard, use Grade A pricing</li> <li>· other fabrics available, contact customer service</li> <li>· attaches with covered button screws</li> <li>· ships attached when ordered with overhead cabinets</li> <li>· com ydg: 3</li> </ul>													

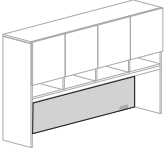
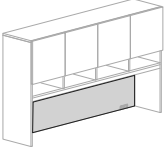
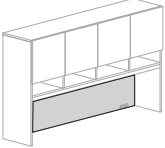

Description	D	W	H	CTN WT	CU FT	① Model	List Price Per Grade
<b>Tackboard for Front of 84" w Storage Overhead Cabinet with Cubbies</b> 	3/8	82 1/8	13	10	7	<b>VS84TKC</b>	<b>COM</b> \$294 A \$322 B \$375 C \$470 D \$591 E \$711 F \$900 G \$1,102 H \$1,316 I \$1,652 J \$2,055
<ul style="list-style-type: none"> <li>· for use with 84" overhead</li> <li>· Culp Montgomery Sterling panel fabric standard, use Grade A pricing</li> <li>· other fabrics available, contact customer service</li> <li>· attaches with covered button screws</li> <li>· ships attached when ordered with overhead cabinets</li> <li>· com ydg: 2 3/4</li> </ul>							
<b>Tackboard for Front of 78" w Storage Overhead Cabinet with Cubbies</b> 	3/8	76 1/8	13	9	7	<b>VS78TKC</b>	<b>COM</b> \$290 A \$315 B \$364 C \$450 D \$560 E \$669 F \$840 G \$1,024 H \$1,220 I \$1,525 J \$1,892
<ul style="list-style-type: none"> <li>· for use with 78" overhead</li> <li>· Culp Montgomery Sterling panel fabric standard, use Grade A pricing</li> <li>· other fabrics available, contact customer service</li> <li>· attaches with covered button screws</li> <li>· ships attached when ordered with overhead cabinets</li> <li>· com ydg: 2 1/2</li> </ul>							
<b>Tackboard for Front of 72" w Storage Overhead Cabinet with Cubbies</b> 	3/8	70 1/8	13	8	6	<b>VS72TKC</b>	<b>COM</b> \$272 A \$296 B \$339 C \$416 D \$515 E \$614 F \$768 G \$933 H \$1,108 I \$1,383 J \$1,713
<ul style="list-style-type: none"> <li>· for use with 72" overhead</li> <li>· Culp Montgomery Sterling panel fabric standard, use Grade A pricing</li> <li>· other fabrics available, contact customer service</li> <li>· attaches with covered button screws</li> <li>· ships attached when ordered with overhead cabinets</li> <li>· com ydg: 2 1/4</li> </ul>							


**To Order, Specify:**

- ① Model Number
- ② Fabric Selection: vendor, pattern, color

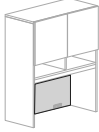
When ordering Quickship products, place a "Q" in front of model number.  
 Example: QVL3072DD



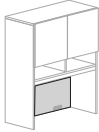
Description	D	W	H	CTN WT	CU FT	① Model	List Price Per Grade
<b>Tackboard for Front of 66" w Storage Overhead Cabinet with Cubbies</b> 	3/8	64 1/8	13	8	6	VS66TKC	COM \$255
							A \$275
							B \$313
							C \$383
							D \$470
							E \$558
							F \$695
							G \$842
							H \$998
							I \$1,243
J \$1,536							
<ul style="list-style-type: none"> <li>· for use with 66" overhead</li> <li>· Culp Montgomery Sterling panel fabric standard, use Grade A pricing</li> <li>· other fabrics available, contact customer service</li> <li>· attaches with covered button screws</li> <li>· ships attached when ordered with overhead cabinets</li> <li>· com ydg: 2</li> </ul>							
<b>Tackboard for Front of 60" w Storage Overhead Cabinet with Cubbies</b> 	3/8	58 1/8	13	7	5	VS60TKC	COM \$249
							A \$269
							B \$308
							C \$377
							D \$465
							E \$553
							F \$689
							G \$836
							H \$993
							I \$1,237
J \$1,530							
<ul style="list-style-type: none"> <li>· for use with 60" overhead</li> <li>· Culp Montgomery Sterling panel fabric standard, use Grade A pricing</li> <li>· other fabrics available, contact customer service</li> <li>· attaches with covered button screws</li> <li>· ships attached when ordered with overhead cabinets</li> <li>· com ydg: 2</li> </ul>							
<b>Tackboard for Front of 54" w Storage Overhead Cabinet with Cubbies</b> 	3/8	52 1/8	13	7	5	VS54TKC	COM \$231
							A \$249
							B \$283
							C \$343
							D \$420
							E \$497
							F \$617
							G \$745
							H \$882
							I \$1,096
J \$1,352							
<ul style="list-style-type: none"> <li>· for use with 54" overhead</li> <li>· Culp Montgomery Sterling panel fabric standard, use Grade A pricing</li> <li>· other fabrics available, contact customer service</li> <li>· attaches with covered button screws</li> <li>· ships attached when ordered with overhead cabinets</li> <li>· com ydg: 1 3/4</li> </ul>							
<b>Tackboard for Front of 48" w Storage Overhead Cabinet with Cubbies</b> 	3/8	46 1/8	13	7	4	VS48TKC	COM \$227
							A \$245
							B \$279
							C \$339
							D \$416
							E \$493
							F \$613
							G \$741
							H \$878
							I \$1,091
J \$1,348							
<ul style="list-style-type: none"> <li>· for use with 48" overhead</li> <li>· Culp Montgomery Sterling panel fabric standard, use Grade A pricing</li> <li>· other fabrics available, contact customer service</li> <li>· attaches with covered button screws</li> <li>· ships attached when ordered with overhead cabinets</li> <li>· com ydg: 1 3/4</li> </ul>							

Description	D	W	H	CTN WT	CU FT	① Model	List Price Per Grade
<b>Tackboard for Front of 42" w Storage Overhead Cabinet with Cubbies</b> 	3/8	40 1/8	13	6	4	VS42TKC	COM \$209
							A \$225
							B \$254
							C \$305
							D \$371
							E \$437
							F \$540
							G \$649
							H \$767
							I \$951
J \$1,170							

- for use with 42" overhead
- Culp Montgomery Sterling panel fabric standard, use Grade A pricing
- other fabrics available, contact customer service
- attaches with covered button screws
- ships attached when ordered with overhead cabinets
- com ydg: 1 1/2

<b>Tackboard for Front of 36" w Storage Overhead Cabinet with Cubbies</b> 	3/8	34 1/8	13	5	3	VS36TKC	COM \$188
							A \$201
							B \$225
							C \$268
							D \$324
							E \$378
							F \$464
							G \$556
							H \$654
							I \$806
J \$990							

- for use with 36" overhead
- Culp Montgomery Sterling panel fabric standard, use Grade A pricing
- other fabrics available, contact customer service
- attaches with covered button screws
- ships attached when ordered with overhead cabinets
- com ydg: 1 1/4

<b>Tackboard for Front of 30" w Storage Overhead Cabinet with Cubbies</b> 	3/8	28 1/8	13	5	2	VS30TKC	COM \$168
							A \$181
							B \$205
							C \$248
							D \$304
							E \$359
							F \$444
							G \$536
							H \$634
							I \$786
J \$970							

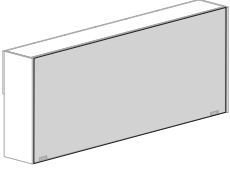
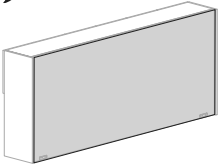
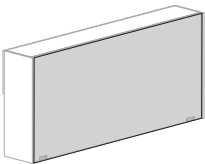
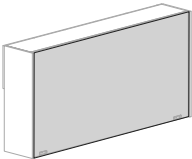
- for use with 30" overhead
- Culp Montgomery Sterling panel fabric standard, use Grade A pricing
- other fabrics available, contact customer service
- attaches with covered button screws
- ships attached when ordered with overhead cabinets
- com ydg: 1 1/4

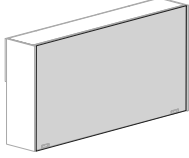
**To Order, Specify:**

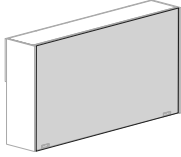
- ① Model Number
- ② Fabric Selection: vendor, pattern, color

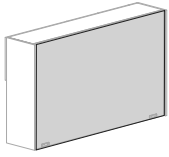
When ordering Quickship products, place a "Q" in front of model number.  
Example: QVL3072DD



Description	D	W	H	CTN WT	CU FT	① Model	List Price Per Grade
<b>Tackboard for Back of 108" w Storage Overhead Cabinet</b> 	3/8	106	42	48	13	VS10842STB	COM \$585
							A \$618
							B \$681
							C \$792
							D \$935
							E \$1,079
							F \$1,300
							G \$1,539
							H \$1,793
							I \$2,190
J \$2,666							
<ul style="list-style-type: none"> <li>· for use with 108" wide storage overhead cabinet</li> <li>· Culp Montgomery Sterling panel fabric standard, use Grade A pricing</li> <li>· other fabrics available, contact customer service</li> <li>· attaches with covered button screws</li> <li>· ships attached when ordered with overhead cabinets</li> <li>· com ydg: 3 1/4</li> </ul>							
<b>Tackboard for Back of 102" w Storage Overhead Cabinet</b> 	3/8	100	42	44	13	VS10242STB	COM \$571
							A \$603
							B \$666
							C \$777
							D \$920
							E \$1,064
							F \$1,286
							G \$1,524
							H \$1,778
							I \$2,175
J \$2,652							
<ul style="list-style-type: none"> <li>· for use with 102" wide storage overhead cabinet</li> <li>· Culp Montgomery Sterling panel fabric standard, use Grade A pricing</li> <li>· other fabrics available, contact customer service</li> <li>· attaches with covered button screws</li> <li>· ships attached when ordered with overhead cabinets</li> <li>· com ydg: 3 1/4</li> </ul>							
<b>Tackboard for Back of 96" w Storage Overhead Cabinet</b> 	3/8	94	42	38	12	VS9642STB	COM \$536
							A \$566
							B \$624
							C \$727
							D \$859
							E \$991
							F \$1,196
							G \$1,416
							H \$1,651
							I \$2,018
J \$2,457							
<ul style="list-style-type: none"> <li>· for use with 96" wide storage overhead cabinet</li> <li>· Culp Montgomery Sterling panel fabric standard, use Grade A pricing</li> <li>· other fabrics available, contact customer service</li> <li>· attaches with covered button screws</li> <li>· ships attached when ordered with overhead cabinets</li> <li>· com ydg: 3</li> </ul>							
<b>Tackboard for Back of 90" w Storage Overhead Cabinet</b> 	3/8	88	42	35	11	VS9042STB	COM \$515
							A \$545
							B \$603
							C \$706
							D \$838
							E \$970
							F \$1,175
							G \$1,395
							H \$1,630
							I \$1,997
J \$2,436							
<ul style="list-style-type: none"> <li>· for use with 90" wide storage overhead cabinet</li> <li>· Culp Montgomery Sterling panel fabric standard, use Grade A pricing</li> <li>· other fabrics available, contact customer service</li> <li>· attaches with covered button screws</li> <li>· ships attached when ordered with overhead cabinets</li> <li>· com ydg: 3</li> </ul>							

Description	D	W	H	CTN WT	CU FT	① Model	List Price Per Grade
<b>Tackboard for Back of 84" w Storage Overhead Cabinet</b>	<sup>3</sup> / <sub>8</sub>	82	42	33	10	<b>VS8442STB</b>	<b>COM \$437</b>
 <p><b>NOW!</b></p> <ul style="list-style-type: none"> <li>for use with 84" wide storage overhead cabinet</li> <li>Culp Montgomery Sterling panel fabric standard, use Grade A pricing</li> <li>other fabrics available, contact customer service</li> <li>attaches with covered button screws</li> <li>ships attached when ordered with overhead cabinets</li> <li>com ydg: 2 <sup>3</sup>/<sub>4</sub></li> </ul>	A	\$465					
	B	\$518					
	C	\$613					
	D	\$733					
	E	\$854					
	F	\$1,043					
	G	\$1,245					
	H	\$1,459					
	I	\$1,795					
	J	\$2,198					

<b>Tackboard for Back of 78" w Storage Overhead Cabinet</b>	<sup>3</sup> / <sub>8</sub>	76	42	30	10	<b>VS7842STB</b>	<b>COM \$422</b>
 <p><b>NOW!</b></p> <ul style="list-style-type: none"> <li>for use with 78" wide storage overhead cabinet</li> <li>Culp Montgomery Sterling panel fabric standard, use Grade A pricing</li> <li>other fabrics available, contact customer service</li> <li>attaches with covered button screws</li> <li>ships attached when ordered with overhead cabinets</li> <li>com ydg: 2 <sup>1</sup>/<sub>2</sub></li> </ul>	A	\$447					
	B	\$495					
	C	\$581					
	D	\$691					
	E	\$801					
	F	\$972					
	G	\$1,155					
	H	\$1,351					
	I	\$1,656					
	J	\$2,023					

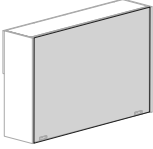
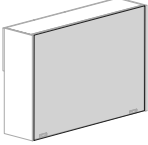
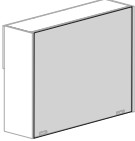
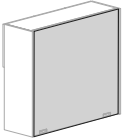
<b>Tackboard for Back of 72" w Storage Overhead Cabinet</b>	<sup>3</sup> / <sub>8</sub>	70	42	27	9	<b>VS7242STB</b>	<b>COM \$394</b>
 <p><b>NOW!</b></p> <ul style="list-style-type: none"> <li>for use with 72" wide storage overhead cabinet</li> <li>Culp Montgomery Sterling panel fabric standard, use Grade A pricing</li> <li>other fabrics available, contact customer service</li> <li>attaches with covered button screws</li> <li>ships attached when ordered with overhead cabinets</li> <li>com ydg: 2 <sup>1</sup>/<sub>4</sub></li> </ul>	A	\$417					
	B	\$460					
	C	\$538					
	D	\$637					
	E	\$735					
	F	\$890					
	G	\$1,055					
	H	\$1,230					
	I	\$1,505					
	J	\$1,835					

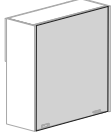
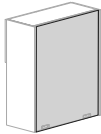
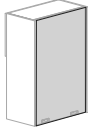
**To Order, Specify:**

- ① Model Number
- ② Fabric Selection: vendor, pattern, color

When ordering Quickship products, place a "Q" in front of model number.  
Example: QVL3072DD

**NOW!**  
*Need it.*  
JSI Quickship

Description	D	W	H	CTN WT	CU FT	① Model	List Price Per Grade
<b>Tackboard for Back of 66" w Storage Overhead Cabinet</b>  <p><b>NOW!</b></p> <ul style="list-style-type: none"> <li>· for use with 66" wide storage overhead cabinet</li> <li>· Culp Montgomery Sterling panel fabric standard, use Grade A pricing</li> <li>· other fabrics available, contact customer service</li> <li>· attaches with covered button screws</li> <li>· ships attached when ordered with overhead cabinets</li> <li>· com ydg: 2</li> </ul>	3/8	64	42	24	8	VS6642STB	COM \$368
							A \$388
							B \$427
							C \$496
							D \$583
							E \$671
							F \$808
							G \$955
							H \$1,111
							I \$1,356
J \$1,649							
<b>Tackboard for Back of 60" w Storage Overhead Cabinet</b>  <p><b>NOW!</b></p> <ul style="list-style-type: none"> <li>· for use with 60" wide storage overhead cabinet</li> <li>· Culp Montgomery Sterling panel fabric standard, use Grade A pricing</li> <li>· other fabrics available, contact customer service</li> <li>· attaches with covered button screws</li> <li>· ships attached when ordered with overhead cabinets</li> <li>· com ydg: 2</li> </ul>	3/8	58	42	21	8	VS6042STB	COM \$353
							A \$373
							B \$412
							C \$481
							D \$569
							E \$657
							F \$793
							G \$940
							H \$1,097
							I \$1,341
J \$1,634							
<b>Tackboard for Back of 54" w Storage Overhead Cabinet</b>  <p><b>NOW!</b></p> <ul style="list-style-type: none"> <li>· for use with 54" wide storage overhead cabinet</li> <li>· Culp Montgomery Sterling panel fabric standard, use Grade A pricing</li> <li>· other fabrics available, contact customer service</li> <li>· attaches with covered button screws</li> <li>· ships attached when ordered with overhead cabinets</li> <li>· com ydg: 1 3/4</li> </ul>	3/8	52	42	18	7	VS5442STB	COM \$324
							A \$342
							B \$375
							C \$435
							D \$513
							E \$590
							F \$709
							G \$837
							H \$975
							I \$1,188
J \$1,444							
<b>Tackboard for Back of 48" w Storage Overhead Cabinet</b>  <p><b>NOW!</b></p> <ul style="list-style-type: none"> <li>· for use with 48" wide storage overhead cabinet</li> <li>· Culp Montgomery Sterling panel fabric standard, use Grade A pricing</li> <li>· other fabrics available, contact customer service</li> <li>· attaches with covered button screws</li> <li>· ships attached when ordered with overhead cabinets</li> <li>· com ydg: 1 3/4</li> </ul>	3/8	46	42	15	6	VS4842STB	COM \$313
							A \$331
							B \$365
							C \$425
							D \$502
							E \$579
							F \$699
							G \$827
							H \$964
							I \$1,178
J \$1,434							

Description	D	W	H	CTN WT	CU FT	① Model	List Price Per Grade
<b>Tackboard for Back of 42" w Storage Overhead Cabinet</b> 	3/8	40	42	12	5	VS4242STB	COM \$287
							A \$303
							B \$331
							C \$383
							D \$449
							E \$515
							F \$618
							G \$727
							H \$845
							I \$1,028
J \$1,248							
<b>Tackboard for Back of 36" w Storage Overhead Cabinet</b> 	3/8	34	42	8	5	VS3642STB	COM \$258
							A \$270
							B \$294
							C \$338
							D \$393
							E \$448
							F \$533
							G \$625
							H \$723
							I \$875
J \$1,059							
<b>Tackboard for Back of 30" w Storage Overhead Cabinet</b> 	3/8	28	42	7	4	VS3042STB	COM \$230
							A \$243
							B \$267
							C \$310
							D \$366
							E \$420
							F \$506
							G \$598
							H \$696
							I \$848
J \$1,032							

**To Order, Specify:**


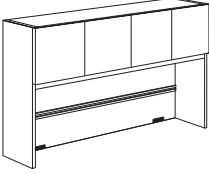
- ① Model Number
- ② Fabric Selection: vendor, pattern, color

When ordering Quickship products, place a "Q" in front of model number.  
 Example: QVL3072DD

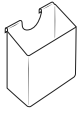

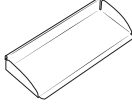
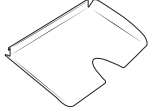
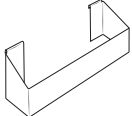


VISION - LAMINATE



Description	D	W	H	CTN WT	CU FT	① Model	List Price
Accessory Rail	3/4	106 1/8	3 1/4	9	3	VS108AR	\$367
 	3/4	100 1/8	3 1/4	8	3	VS102AR	\$352
	3/4	94 1/8	3 1/4	7	3	VS96AR	\$324
	3/4	88 1/8	3 1/4	7	3	VS90AR	\$308
	3/4	82 1/8	3 1/4	6	2	VS84AR	\$293
	3/4	76 1/8	3 1/4	6	2	VS78AR	\$279
	3/4	70 1/8	3 1/4	5	2	VS72AR	\$265
	3/4	64 1/8	3 1/4	4	2	VS66AR	\$250
	3/4	58 1/8	3 1/4	4	2	VS60AR	\$236
	3/4	52 1/8	3 1/4	4	2	VS54AR	\$221
	3/4	46 1/8	3 1/4	3	2	VS48AR	\$207
	3/4	40 1/8	3 1/4	3	1	VS42AR	\$194
	3/4	34 1/8	3 1/4	3	1	VS36AR	\$178
	3/4	28 1/8	3 1/4	2	1	VS30AR	\$164

VISION - LAMINATE

Description	D	W	H	CTN WT	CU FT	① Model	List Price
<b>Upright Tray</b>  <ul style="list-style-type: none"> <li>pen and gadget cup</li> <li>Stardust Silver finish</li> </ul>	1 9/16	3 1/8	3 9/16	1	1	AC203CUP	\$75 <sup>▲</sup>
<b>Small Tray</b>  <ul style="list-style-type: none"> <li>tray for paper clips and other small items</li> <li>Stardust Silver finish</li> </ul>	3 5/16	2 11/16	7/8	1	1	AC403TRAY	\$56 <sup>▲</sup>
<b>Pencil Tray</b>  <ul style="list-style-type: none"> <li>tray for pencils and other small items</li> <li>Stardust Silver finish</li> </ul>	3 5/16	7 11/16	7/8	1	1	AC408TRAY	\$69 <sup>▲</sup>
<b>Paper Tray</b>  <ul style="list-style-type: none"> <li>tray for 8 1/2 x 11" letter paper size</li> <li>Stardust Silver finish</li> </ul>	9 15/16	13 3/16	7/8	2	1	AC912PAP	\$107 <sup>▲</sup>
<b>File Hanger</b>  <ul style="list-style-type: none"> <li>file hanger for 8 1/2 x 11" letter size hanging file folders</li> <li>Stardust Silver finish</li> </ul>	2 13/16	12 3/16	4	1	1	AC313FILE	\$101 <sup>▲</sup>

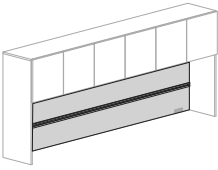
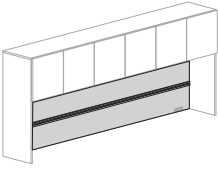
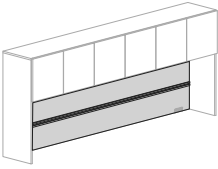
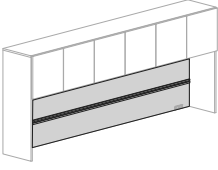
VISION - LAMINATE

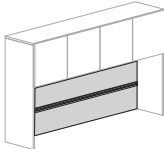
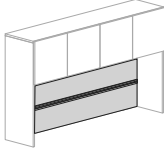
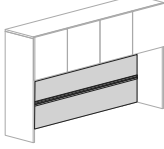
**To Order, Specify:**

① Model Number

When ordering Quickship products, place a "Q" in front of model number.  
 Example: QVL3072DD

**NOW!**  
*Need it.*  
 JSI Quickship

Description	D	W	H	CTN WT	CU FT	① Model	List Price Per Grade
<b>Tackboard for Accessory Rail of 108" w Storage Overhead Cabinet</b> 	3/8	106 1/8		14	9	VS108TKA	COM \$389
							A \$422
							B \$485
							C \$596
							D \$739
							E \$882
							F \$1,104
							G \$1,342
							H \$1,596
							I \$1,993
J \$2,470							
<ul style="list-style-type: none"> <li>tackboard panels for above and below accessory rail</li> <li>not required; add-on for convenience application</li> <li>Culp Montgomery Sterling panel fabric standard, use Grade A pricing</li> <li>other fabrics available, contact Customer Service</li> <li>com ydg: 3 1/4</li> <li>upper tackboard height: 8 1/4"</li> <li>lower tackboard height: 7 1/2"</li> <li>coordinates with VL16108DGSO, VL16108GSO, VL16108DSO, VL16108SO, VL16108DSD and VL16108SD</li> <li>accessory rail sold separately, see page 128</li> </ul>							
<b>Tackboard for Accessory Rail of 102" w Storage Overhead Cabinet</b> 	3/8	100 1/8		13	9	VS102TKA	COM \$387
							A \$419
							B \$482
							C \$594
							D \$737
							E \$880
							F \$1,102
							G \$1,340
							H \$1,594
							I \$1,991
J \$2,468							
<ul style="list-style-type: none"> <li>tackboard panels for above and below accessory rail</li> <li>not required; add-on for convenience application</li> <li>Culp Montgomery Sterling panel fabric standard, use Grade A pricing</li> <li>other fabrics available, contact Customer Service</li> <li>com ydg: 3 1/4</li> <li>upper tackboard height: 8 1/4"</li> <li>lower tackboard height: 7 1/2"</li> <li>coordinates with VL16102DGSO, VL16102GSO, VL16102DSO, VL16102SO, VL16102DSD and VL16102SD</li> <li>accessory rail sold separately, see page 128</li> </ul>							
<b>Tackboard for Accessory Rail of 96" w Storage Overhead Cabinet</b> 	3/8	94 1/8		12	8	VS96TKA	COM \$372
							A \$403
							B \$460
							C \$563
							D \$696
							E \$827
							F \$1,033
							G \$1,252
							H \$1,487
							I \$1,854
J \$2,294							
<ul style="list-style-type: none"> <li>tackboard panels for above and below accessory rail</li> <li>not required; add-on for convenience application</li> <li>Culp Montgomery Sterling panel fabric standard, use Grade A pricing</li> <li>other fabrics available, contact Customer Service</li> <li>com ydg: 3</li> <li>upper tackboard height: 8 1/4"</li> <li>lower tackboard height: 7 1/2"</li> <li>coordinates with VL1696DGSO, VL1696GSO, VL1696DSO, VL1696SO, VL1696DSD and VL1696SD</li> <li>accessory rail sold separately, see page 128</li> </ul>							
<b>Tackboard for Accessory Rail of 90" w Storage Overhead Cabinet</b> 	3/8	88 1/8		11	8	VS90TKA	COM \$369
							A \$399
							B \$457
							C \$560
							D \$692
							E \$824
							F \$1,029
							G \$1,249
							H \$1,484
							I \$1,851
J \$2,291							
<ul style="list-style-type: none"> <li>tackboard panels for above and below accessory rail</li> <li>not required; add-on for convenience application</li> <li>Culp Montgomery Sterling panel fabric standard, use Grade A pricing</li> <li>other fabrics available, contact Customer Service</li> <li>com ydg: 3</li> <li>upper tackboard height: 8 1/4"</li> <li>lower tackboard height: 7 1/2"</li> <li>coordinates with VL1690DGSO, VL1690GSO, VL1690DSO, VL1690SO, VL1690DSD and VL1690SD</li> <li>accessory rail sold separately, see page 128</li> </ul>							

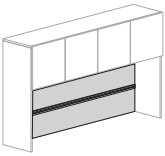

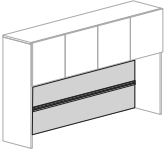

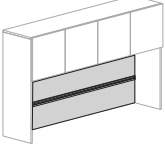

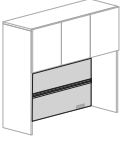

Description	D	W	H	CTN WT	CU FT	① Model	List Price Per Grade
<b>Tackboard for Accessory Rail of 84" w Storage Overhead Cabinet</b> 	3/8	82 1/8		10	7	<b>VS84TKA</b>	<b>COM \$327</b> A \$354 B \$408 C \$502 D \$623 E \$744 F \$933 G \$1,134 H \$1,349 I \$1,685 J \$2,088
<ul style="list-style-type: none"> <li>tackboard panels for above and below accessory rail</li> <li>not required; add-on for convenience application</li> <li>Culp Montgomery Sterling panel fabric standard, use Grade A pricing</li> <li>other fabrics available, contact Customer Service</li> <li>com ydg: 2 3/4</li> <li>upper tackboard height: 8 1/4"</li> <li>lower tackboard height: 7 1/2"</li> <li>coordinates with VL1684DGSO, VL1684GSO, VL1684DSO, VL1684SO, VL1684DSD and VL1684SD</li> <li>accessory rail sold separately, see page 128</li> </ul>							
<b>Tackboard for Accessory Rail of 78" w Storage Overhead Cabinet</b> 	3/8	76 1/8		9	7	<b>VS78TKA</b>	<b>COM \$322</b> A \$347 B \$395 C \$481 D \$592 E \$701 F \$872 G \$1,056 H \$1,251 I \$1,557 J \$1,923
<ul style="list-style-type: none"> <li>tackboard panels for above and below accessory rail</li> <li>not required; add-on for convenience application</li> <li>Culp Montgomery Sterling panel fabric standard, use Grade A pricing</li> <li>other fabrics available, contact Customer Service</li> <li>com ydg: 2 1/2</li> <li>upper tackboard height: 8 1/4"</li> <li>lower tackboard height: 7 1/2"</li> <li>coordinates with VL1678DGSO, VL1678GSO, VL1678DSO, VL1678SO, VL1678DSD and VL1678SD</li> <li>accessory rail sold separately, see page 128</li> </ul>							
<b>Tackboard for Accessory Rail of 72" w Storage Overhead Cabinet</b> 	3/8	70 1/8		8	6	<b>VS72TKA</b>	<b>COM \$305</b> A \$328 B \$371 C \$449 D \$548 E \$646 F \$801 G \$965 H \$1,141 I \$1,416 J \$1,746
<ul style="list-style-type: none"> <li>tackboard panels for above and below accessory rail</li> <li>not required; add-on for convenience application</li> <li>Culp Montgomery Sterling panel fabric standard, use Grade A pricing</li> <li>other fabrics available, contact Customer Service</li> <li>com ydg: 2 1/4</li> <li>upper tackboard height: 8 1/4"</li> <li>lower tackboard height: 7 1/2"</li> <li>coordinates with VL1672DGSO, VL1672GSO, VL1672DSO, VL1672SO, VL1672DSD and VL1672SD</li> <li>accessory rail sold separately, see page 128</li> </ul>							

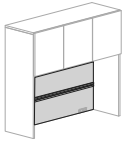
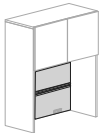
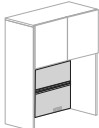
**To Order, Specify:**

- ① Model Number
- ② Fabric Selection: vendor, pattern, color

When ordering Quickship products, place a "Q" in front of model number.  
 Example: QVL3072DD



Description	D	W	H	CTN WT	CU FT	① Model	List Price Per Grade	
<b>Tackboard for Accessory Rail of 66" w Storage Overhead Cabinet</b> 	3/8	64 1/8		8	6	VS66TKA	COM \$286	
							A \$306	
							B \$345	
							C \$414	
							D \$501	
							E \$590	
							F \$726	
							G \$873	
							H \$1,029	
							I \$1,274	
J \$1,567								
 <ul style="list-style-type: none"> <li>tackboard panels for above and below accessory rail</li> <li>not required; add-on for convenience application</li> <li>Culp Montgomery Sterling panel fabric standard, use Grade A pricing</li> <li>other fabrics available, contact Customer Service</li> <li>com ydg: 2</li> <li>upper tackboard height: 8 1/4"</li> <li>lower tackboard height: 7 1/2"</li> <li>coordinates with VL1666DGSO, VL1666GSO, VL1666DSO, VL1666SO, VL1666DSD and VL1666SD</li> <li>accessory rail sold separately, see page 128</li> </ul>								
	<b>Tackboard for Accessory Rail of 60" w Storage Overhead Cabinet</b> 	3/8	58 1/8		7	5	VS60TKA	COM \$282
								A \$302
								B \$341
								C \$410
								D \$497
								E \$585
								F \$722
								G \$869
								H \$1,025
I \$1,270								
J \$1,563								
 <ul style="list-style-type: none"> <li>tackboard panels for above and below accessory rail</li> <li>not required; add-on for convenience application</li> <li>Culp Montgomery Sterling panel fabric standard, use Grade A pricing</li> <li>other fabrics available, contact Customer Service</li> <li>com ydg: 2</li> <li>upper tackboard height: 8 1/4"</li> <li>lower tackboard height: 7 1/2"</li> <li>coordinates with VL1660DGSO, VL1660GSO, VL1660DSO, VL1660SO, VL1660DSD and VL1660SD</li> <li>accessory rail sold separately, see page 128</li> </ul>								
	<b>Tackboard for Accessory Rail of 54" w Storage Overhead Cabinet</b> 	3/8	52 1/8		7	5	VS54TKA	COM \$264
								A \$282
								B \$315
								C \$375
								D \$453
								E \$530
								F \$649
								G \$777
								H \$915
I \$1,128								
J \$1,384								
 <ul style="list-style-type: none"> <li>tackboard panels for above and below accessory rail</li> <li>not required; add-on for convenience application</li> <li>Culp Montgomery Sterling panel fabric standard, use Grade A pricing</li> <li>other fabrics available, contact Customer Service</li> <li>com ydg: 1 3/4</li> <li>upper tackboard height: 8 1/4"</li> <li>lower tackboard height: 7 1/2"</li> <li>coordinates with VL1654DGSO, VL1654GSO, VL1654DSO, VL1654SO, VL1654DSD and VL1654SD</li> <li>accessory rail sold separately, see page 128</li> </ul>								
	<b>Tackboard for Accessory Rail of 48" w Storage Overhead Cabinet</b> 	3/8	46 1/8		7	4	VS48TKA	COM \$260
								A \$278
								B \$311
								C \$371
								D \$449
								E \$525
								F \$645
								G \$773
								H \$911
I \$1,124								
J \$1,380								
 <ul style="list-style-type: none"> <li>tackboard panels for above and below accessory rail</li> <li>not required; add-on for convenience application</li> <li>Culp Montgomery Sterling panel fabric standard, use Grade A pricing</li> <li>other fabrics available, contact Customer Service</li> <li>com ydg: 1 3/4</li> <li>upper tackboard height: 8 1/4"</li> <li>lower tackboard height: 7 1/2"</li> <li>coordinates with VL1648DGSO, VL1648GSO, VL1648DSO, VL1648SO, VL1648DSD and VL1648SD</li> <li>accessory rail sold separately, see page 128</li> </ul>								

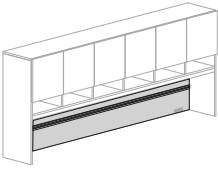
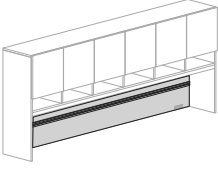
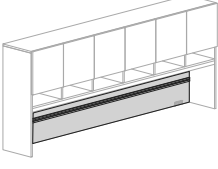
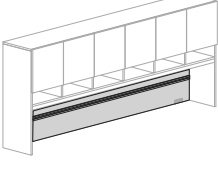
Description	D	W	H	CTN WT	CU FT	① Model	List Price Per Grade
<b>Tackboard for Accessory Rail of 42" w Storage Overhead Cabinet</b> 	3/8	40 1/8		6	4	<b>VS42TKA</b>	<b>COM \$242</b> A \$258 B \$286 C \$338 D \$404 E \$470 F \$573 G \$682 H \$800 I \$983 J \$1,203
<ul style="list-style-type: none"> <li>tackboard panels for above and below accessory rail</li> <li>not required; add-on for convenience application</li> <li>Culp Montgomery Sterling panel fabric standard, use Grade A pricing</li> <li>other fabrics available, contact Customer Service</li> <li>com ydg: 1 1/2</li> <li>upper tackboard height: 8 1/4"</li> <li>lower tackboard height: 7 1/2"</li> <li>coordinates with VL1642DGSO, VL1642GSO, VL1642DSO, VL1642SO, VL1642DSD and VL1642SD</li> <li>accessory rail sold separately, see page 128</li> </ul>							
<b>Tackboard for Accessory Rail of 36" w Storage Overhead Cabinet</b> 	3/8	34 1/8		5	3	<b>VS36TKA</b>	<b>COM \$221</b> A \$234 B \$258 C \$301 D \$356 E \$411 F \$496 G \$588 H \$686 I \$838 J \$1,022
<ul style="list-style-type: none"> <li>tackboard panels for above and below accessory rail</li> <li>not required; add-on for convenience application</li> <li>Culp Montgomery Sterling panel fabric standard, use Grade A pricing</li> <li>other fabrics available, contact Customer Service</li> <li>com ydg: 1 1/4</li> <li>upper tackboard height: 8 1/4"</li> <li>lower tackboard height: 7 1/2"</li> <li>coordinates with VL1636DGSO, VL1636GSO, VL1636DSO, VL1636SO, VL1636DSD and VL1636SD</li> <li>accessory rail sold separately, see page 128</li> </ul>							
<b>Tackboard for Accessory Rail of 30" w Storage Overhead Cabinet</b> 	3/8	28 1/8		5	2	<b>VS30TKA</b>	<b>COM \$201</b> A \$214 B \$238 C \$281 D \$336 E \$391 F \$476 G \$569 H \$666 I \$818 J \$1,002
<ul style="list-style-type: none"> <li>tackboard panels for above and below accessory rail</li> <li>not required; add-on for convenience application</li> <li>Culp Montgomery Sterling panel fabric standard, use Grade A pricing</li> <li>other fabrics available, contact Customer Service</li> <li>com ydg: 1 1/4</li> <li>upper tackboard height: 8 1/4"</li> <li>lower tackboard height: 7 1/2"</li> <li>coordinates with VL1630DGSO, VL1630GSO, VL1630DSO, VL1630SO, VL1630DSD and VL1630SD</li> <li>accessory rail sold separately, see page 128</li> </ul>							

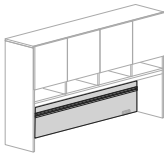
**To Order, Specify:**

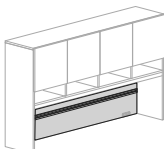
- ① Model Number
- ② Fabric Selection: vendor, pattern, color

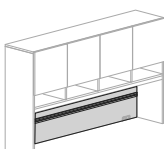
When ordering Quickship products, place a "Q" in front of model number.  
 Example: QVL3072DD



Description	D	W	H	CTN WT	CU FT	① Model	List Price Per Grade
<b>Tackboard for Accessory Rail of 108" w Storage Overhead Cabinet with Cubbies</b> 	3/8	106 1/8		14	9	<b>VS108TKCA</b>	<b>COM</b> \$389
							A \$422
							B \$485
							C \$596
							D \$739
							E \$882
							F \$1,104
							G \$1,342
							H \$1,596
							I \$1,993
J \$2,470							
<ul style="list-style-type: none"> <li>• tackboard panels for above and below accessory rail</li> <li>• not required; add-on for convenience application</li> <li>• Culp Montgomery Sterling panel fabric standard, use Grade A pricing</li> <li>• other fabrics available, contact Customer Service</li> <li>• com ydg: 3 1/4</li> <li>• upper tackboard height: 2 1/4"</li> <li>• lower tackboard height: 7 1/2"</li> <li>• coordinates with VL16108DGSOC, VL16108GSOC, VL16108DSOC, VL16108SOC, VL16108DSDC, VL16108SDC, VL16108SMOC and VL16108GSMOC</li> <li>• accessory rail sold separately, see page 128</li> </ul>							
<b>Tackboard for Accessory Rail of 102" w Storage Overhead Cabinet with Cubbies</b> 	3/8	100 1/8		13	9	<b>VS102TKCA</b>	<b>COM</b> \$387
							A \$419
							B \$482
							C \$594
							D \$737
							E \$880
							F \$1,102
							G \$1,340
							H \$1,594
							I \$1,991
J \$2,468							
<ul style="list-style-type: none"> <li>• tackboard panels for above and below accessory rail</li> <li>• not required; add-on for convenience application</li> <li>• Culp Montgomery Sterling panel fabric standard, use Grade A pricing</li> <li>• other fabrics available, contact Customer Service</li> <li>• com ydg: 3 1/4</li> <li>• upper tackboard height: 2 1/4"</li> <li>• lower tackboard height: 7 1/2"</li> <li>• coordinates with VL16102DGSOC, VL16102GSOC, VL16102DSOC, VL16102SOC, VL16102DSDC, VL16102SDC, VL16102SMOC and VL16102GSMOC</li> <li>• accessory rail sold separately, see page 128</li> </ul>							
<b>Tackboard for Accessory Rail of 96" w Storage Overhead Cabinet with Cubbies</b> 	3/8	94 1/8		12	8	<b>VS96TKCA</b>	<b>COM</b> \$372
							A \$403
							B \$460
							C \$563
							D \$696
							E \$827
							F \$1,033
							G \$1,252
							H \$1,487
							I \$1,854
J \$2,294							
<ul style="list-style-type: none"> <li>• tackboard panels for above and below accessory rail</li> <li>• not required; add-on for convenience application</li> <li>• Culp Montgomery Sterling panel fabric standard, use Grade A pricing</li> <li>• other fabrics available, contact Customer Service</li> <li>• com ydg: 3</li> <li>• upper tackboard height: 2 1/4"</li> <li>• lower tackboard height: 7 1/2"</li> <li>• coordinates with VL1696DGSOC, VL1696GSOC, VL1696DSOC, VL1696SOC, VL1696DSDC, VL1696SDC, VL1696SMOC and VL1696GSMOC</li> <li>• accessory rail sold separately, see page 128</li> </ul>							
<b>Tackboard for Accessory Rail of 90" w Storage Overhead Cabinet with Cubbies</b> 	3/8	88 1/8		11	8	<b>VS90TKCA</b>	<b>COM</b> \$369
							A \$399
							B \$457
							C \$560
							D \$692
							E \$824
							F \$1,029
							G \$1,249
							H \$1,484
							I \$1,851
J \$2,291							
<ul style="list-style-type: none"> <li>• tackboard panels for above and below accessory rail</li> <li>• not required; add-on for convenience application</li> <li>• Culp Montgomery Sterling panel fabric standard, use Grade A pricing</li> <li>• other fabrics available, contact Customer Service</li> <li>• com ydg: 3</li> <li>• upper tackboard height: 2 1/4"</li> <li>• lower tackboard height: 7 1/2"</li> <li>• coordinates with VL1690DGSOC, VL1690GSOC, VL1690DSOC, VL1690SOC, VL1690DSDC, VL1690SDC, VL1690SMOC and VL1690GSMOC</li> <li>• accessory rail sold separately, see page 128</li> </ul>							

Description	D	W	H	CTN WT	CU FT	① Model	List Price Per Grade
<b>Tackboard for Accessory Rail of 84" w Storage Overhead Cabinet with Cubbies</b> 	3/8	82 1/8		10	7	VS84TKCA	COM \$327
							A \$354
							B \$408
							C \$502
							D \$623
							E \$744
							F \$933
							G \$1,134
							H \$1,349
							I \$1,685
							J \$2,088

<b>Tackboard for Accessory Rail of 78" w Storage Overhead Cabinet with Cubbies</b> 	3/8	76 1/8		9	7	VS78TKCA	COM \$322
							A \$347
							B \$395
							C \$481
							D \$592
							E \$701
							F \$872
							G \$1,056
							H \$1,251
							I \$1,557
							J \$1,923

<b>Tackboard for Accessory Rail of 72" w Storage Overhead Cabinet with Cubbies</b> 	3/8	70 1/8		8	6	VS72TKCA	COM \$305
							A \$328
							B \$371
							C \$449
							D \$548
							E \$646
							F \$801
							G \$965
							H \$1,141
							I \$1,416
							J \$1,746

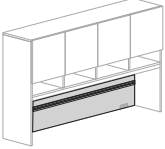
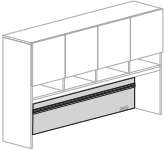
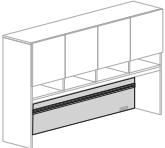
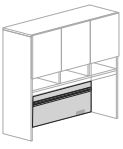
**To Order, Specify:**





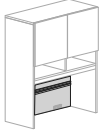
- ① Model Number
- ② Fabric Selection: vendor, pattern, color

When ordering Quickship products, place a "Q" in front of model number.  
 Example: QVL3072DD





Description	D	W	H	CTN WT	CU FT	① Model	List Price Per Grade
<b>Tackboard for Accessory Rail of 66" w Storage Overhead Cabinet with Cubbies</b> 	3/8	64 1/8		8	6	VS66TKCA	COM \$286
							A \$306
							B \$345
							C \$414
							D \$501
							E \$590
							F \$726
							G \$873
							H \$1,029
							I \$1,274
J \$1,567							
<ul style="list-style-type: none"> <li>• tackboard panels for above and below accessory rail</li> <li>• not required; add-on for convenience application</li> <li>• Culp Montgomery Sterling panel fabric standard, use Grade A pricing</li> <li>• other fabrics available, contact Customer Service</li> <li>• com ydg: 2</li> <li>• upper tackboard height: 2 1/4"</li> <li>• lower tackboard height: 7 1/2"</li> <li>• coordinates with VL1666DGSOC, VL1666GSOC, VL1666DSOC, VL1666SOC, VL1666DSDC, VL1666SDC, VL1666SMOC and VL1666GSMOC</li> <li>• accessory rail sold separately, see page 128</li> </ul>							
<b>Tackboard for Accessory Rail of 60" w Storage Overhead Cabinet with Cubbies</b> 	3/8	58 1/8		7	5	VS60TKCA	COM \$282
							A \$302
							B \$341
							C \$410
							D \$497
							E \$585
							F \$722
							G \$869
							H \$1,025
							I \$1,270
J \$1,563							
<ul style="list-style-type: none"> <li>• tackboard panels for above and below accessory rail</li> <li>• not required; add-on for convenience application</li> <li>• Culp Montgomery Sterling panel fabric standard, use Grade A pricing</li> <li>• other fabrics available, contact Customer Service</li> <li>• com ydg: 2</li> <li>• upper tackboard height: 2 1/4"</li> <li>• lower tackboard height: 7 1/2"</li> <li>• coordinates with VL1660DGSOC, VL1660GSOC, VL1660DSOC, VL1660SOC, VL1660DSDC, VL1660SDC, VL1660SMOC and VL1660GSMOC</li> <li>• accessory rail sold separately, see page 128</li> </ul>							
<b>Tackboard for Accessory Rail of 54" w Storage Overhead Cabinet with Cubbies</b> 	3/8	52 1/8		7	5	VS54TKCA	COM \$264
							A \$282
							B \$315
							C \$375
							D \$453
							E \$530
							F \$649
							G \$777
							H \$915
							I \$1,128
J \$1,384							
<ul style="list-style-type: none"> <li>• tackboard panels for above and below accessory rail</li> <li>• not required; add-on for convenience application</li> <li>• Culp Montgomery Sterling panel fabric standard, use Grade A pricing</li> <li>• other fabrics available, contact Customer Service</li> <li>• com ydg: 1 3/4</li> <li>• upper tackboard height: 2 1/4"</li> <li>• lower tackboard height: 7 1/2"</li> <li>• coordinates with VL1654DGSOC, VL1654GSOC, VL1654DSOC, VL1654SOC, VL1654DSDC, VL1654SDC, VL1654SMOC and VL1654GSMOC</li> <li>• accessory rail sold separately, see page 128</li> </ul>							
<b>Tackboard for Accessory Rail of 48" w Storage Overhead Cabinet with Cubbies</b> 	3/8	46 1/8	Adj.	7	4	VS48TKCA	COM \$260
							A \$278
							B \$311
							C \$371
							D \$449
							E \$525
							F \$645
							G \$773
							H \$911
							I \$1,124
J \$1,380							
<ul style="list-style-type: none"> <li>• tackboard panels for above and below accessory rail</li> <li>• not required; add-on for convenience application</li> <li>• Culp Montgomery Sterling panel fabric standard, use Grade A pricing</li> <li>• other fabrics available, contact Customer Service</li> <li>• com ydg: 1 3/4</li> <li>• upper tackboard height: 2 1/4"</li> <li>• lower tackboard height: 7 1/2"</li> <li>• coordinates with VL1648DGSOC, VL1648GSOC, VL1648DSOC, VL1648SOC, VL1648DSDC and VL1648SDC</li> <li>• accessory rail sold separately, see page XX</li> </ul>							

Description	D	W	H	CTN WT	CU FT	① Model	List Price Per Grade
<b>Tackboard for Accessory Rail of 42" w Storage Overhead Cabinet with Cubbies</b> 	3/8	40 1/8		6	4	VS42TKCA	COM \$242
							A \$258
							B \$286
							C \$338
							D \$404
							E \$470
							F \$573
							G \$682
							H \$800
							I \$983
							J \$1,203
 <b>Tackboard for Accessory Rail of 36" w Storage Overhead Cabinet with Cubbies</b> 	3/8	34 1/8		5	3	VS36TKCA	COM \$221
							A \$234
							B \$258
							C \$301
							D \$356
							E \$411
							F \$496
							G \$588
							H \$686
							I \$838
							J \$1,022
 <b>Tackboard for Accessory Rail of 30" w Storage Overhead Cabinet with Cubbies</b> 	3/8	28 1/8		5	2	VS30TKCA	COM \$201
							A \$214
							B \$238
							C \$281
							D \$336
							E \$391
							F \$476
							G \$569
							H \$666
							I \$818
							J \$1,002

**To Order, Specify:**

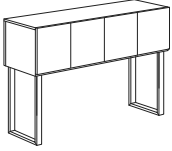
- ① Model Number
- ② Fabric Selection: vendor, pattern, color

When ordering Quickship products, place a "Q" in front of model number.  
 Example: QVL3072DD



Description	D	W	H	CTN WT	CU FT	① Model	List Price
<b>37" h Post Support Overhead Cabinet with Four Doors</b>	16	72	37	194	16	<b>VL1672PSHD-37</b>	\$1,420
	16	66	37	181	15	<b>VL1666PSHD-37</b>	\$1,396
	16	60	37	170	13	<b>VL1660PSHD-37</b>	\$1,377
	16	54	37	167	12	<b>VL1654PSHD-37</b>	\$1,280

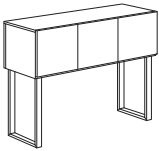
**NOW!**



- locking doors available, specify and add \$210 list
- 21 <sup>13</sup>/<sub>16</sub>" vertical clearance
- no pulls
- post support legs to be field installed

<b>37" h Post Support Overhead Cabinet with Three Doors</b>	16	48	37	157	11	<b>VL1648PSHDR-37</b>	\$1,184
	16	48	37	157	11	<b>VL1648PSHDL-37</b>	\$1,184
	16	42	37	146	10	<b>VL1642PSHDR-37</b>	\$955
	16	42	37	146	10	<b>VL1642PSHDL-37</b>	\$955

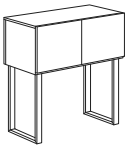
**NOW!**



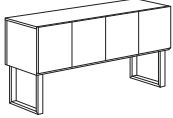
- locking doors available, specify and add \$210 list
- 21 <sup>13</sup>/<sub>16</sub>" vertical clearance
- right door configuration - 1 door hinges left and 2 doors hinge right
- left door configuration - 1 door hinges right and 2 doors hinge left
- no pulls
- post support legs to be field installed

<b>37" h Post Support Overhead Cabinet with Two Doors</b>	16	36	37	137	9	<b>VL1636PSHD-37</b>	\$864
	16	30	37	132	8	<b>VL1630PSHD-37</b>	\$856

**NOW!**

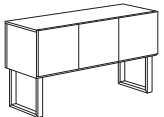


- locking doors available, specify and add \$105 list
- 21 <sup>13</sup>/<sub>16</sub>" vertical clearance
- no pulls
- post support legs to be field installed

Description	D	W	H	CTN WT	CU FT	① Model	List Price
<b>27" h Post Support Overhead Cabinet with Four Doors</b> 	16	72	27	194	16	VL1672PSHD-27	\$1,420
	16	66	27	181	15	VL1666PSHD-27	\$1,396
	16	60	27	170	13	VL1660PSHD-27	\$1,377
	16	54	27	167	12	VL1654PSHD-27	\$1,280

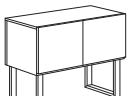
**NOW!**

- locking doors available, specify and add \$210 list
- 12 1/8" vertical clearance
- no pulls
- post support legs to be field installed

<b>27" h Post Support Overhead Cabinet with Three Doors</b> 	16	48	27	157	11	VL1648PSHDR-27	\$1,184
	16	48	27	157	11	VL1648PSHDL-27	\$1,184
	16	42	27	146	10	VL1642PSHDR-27	\$955
	16	42	27	146	10	VL1642PSHDL-27	\$955

**NOW!**

- locking doors available, specify and add \$210 list
- 12 1/8" vertical clearance
- right door configuration - 1 door hinges left and 2 doors hinge right
- left door configuration - 1 door hinges right and 2 doors hinge left
- no pulls
- post support legs to be field installed

<b>27" h Post Support Overhead Cabinet with Two Doors</b> 	16	36	27	137	9	VL1636PSHD-27	\$864
	16	30	27	132	8	VL1630PSHD-27	\$856

**NOW!**

- locking doors available, specify and add \$105 list
- 12 1/8" vertical clearance
- no pulls
- post support legs to be field installed

**To Order, Specify:**

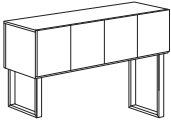
- ① Model Number
- ② Laminate Color (see page 38)
  - a.) Chassis Color
  - b.) Door Color
- ③ Metal Color - Black Sandtex (BSX) or Stardust Silver (STS) (see page 47)
- ④ Other Product Options (see page 39)

When ordering Quickship products, place a "Q" in front of model number.  
 Example: QVL3072DD



Description	D	W	H	CTN WT	CU FT	① Model	List Price
Split Height Post Support Overhead Cabinet with Four Doors	16	72	37	194	16	VL1672PSHD-2737	\$1,420
	16	66	37	181	15	VL1666PSHD-2737	\$1,396
	16	60	37	170	13	VL1660PSHD-2737	\$1,377
	16	54	37	167	12	VL1654PSHD-2737	\$1,280

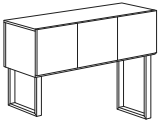
**NOW!**



- locking doors available, specify and add \$210 list
- 12 1/8" - 21 13/16" vertical clearance
- see page 55 for application of split height post support overhead
- no pulls
- post support legs to be field installed

Split Height Post Support Overhead Cabinet with Three Doors	16	48	37	157	11	VL1648PSHDR-2737	\$1,184
	16	48	37	157	11	VL1648PSHDL-2737	\$1,184
	16	42	37	146	10	VL1642PSHDR-2737	\$955
	16	42	37	146	10	VL1642PSHDL-2737	\$955

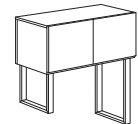
**NOW!**



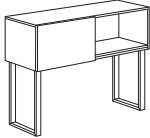
- locking doors available, specify and add \$210 list
- 12 1/8" - 21 13/16" vertical clearance
- see page 55 for application of split height post support overhead
- right door configuration - 1 door hinges left and 2 doors hinge right
- left door configuration - 1 door hinges right and 2 doors hinge left
- no pulls
- post support legs to be field installed

Split Height Post Support Overhead Cabinet with Two Doors	16	36	37	137	9	VL1636PSHD-2737	\$864
	16	30	37	132	8	VL1630PSHD-2737	\$856

**NOW!**



- locking doors available, specify and add \$105 list
- 12 1/8" - 21 13/16" vertical clearance
- see page 55 for application of split height post support overhead
- no pulls
- post support legs to be field installed

Description	D	W	H	CTN WT	CU FT	① Model	List Price
<b>37" h Post Support Overhead Cabinet with Sliding Door</b> 	16	72	37	194	16	VL1672PSSD-37	\$1,600
	16	66	37	181	15	VL1666PSSD-37	\$1,574
	16	60	37	170	13	VL1660PSSD-37	\$1,554
	16	54	37	167	12	VL1654PSSD-37	\$1,459
	16	48	37	157	11	VL1648PSSD-37	\$1,362
	16	42	37	146	10	VL1642PSSD-37	\$1,133
	16	36	37	137	9	VL1636PSSD-37	\$1,042
	16	30	37	132	8	VL1630PSSD-37	\$1,034

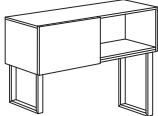
**NOW!**

- 21 13/16" vertical clearance
- white markerboard doors available, specify and add \$163 list
- post support legs to be field installed
- locking doors not available

<b>27" h Post Support Overhead Cabinet with Sliding Door</b> 	16	72	27	194	16	VL1672PSSD-27	\$1,600
	16	66	27	181	15	VL1666PSSD-27	\$1,574
	16	60	27	170	13	VL1660PSSD-27	\$1,554
	16	54	27	167	12	VL1654PSSD-27	\$1,459
	16	48	27	157	11	VL1648PSSD-27	\$1,362
	16	42	27	146	10	VL1642PSSD-27	\$1,133
	16	36	27	137	9	VL1636PSSD-27	\$1,042
	16	30	27	132	8	VL1630PSSD-27	\$1,034

**NOW!**

- 12 1/8" vertical clearance
- white markerboard doors available, specify and add \$163 list
- post support legs to be field installed
- locking doors not available

<b>Split Height Post Support Overhead Cabinet with Sliding Door</b> 	16	72	37	194	16	VL1672PSSD-2737	\$1,600
	16	66	37	181	15	VL1666PSSD-2737	\$1,574
	16	60	37	170	13	VL1660PSSD-2737	\$1,554
	16	54	37	167	12	VL1654PSSD-2737	\$1,459
	16	48	37	157	11	VL1648PSSD-2737	\$1,362
	16	42	37	146	10	VL1642PSSD-2737	\$1,133
	16	36	37	137	9	VL1636PSSD-2737	\$1,042
	16	30	37	132	8	VL1630PSSD-2737	\$1,034

**NOW!**

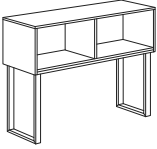
- 12 1/8" - 21 13/16" vertical clearance
- see page 55 for application of split height post support overhead
- white markerboard doors available, specify and add \$163 list
- post support legs to be field installed
- locking doors not available

**To Order, Specify:**

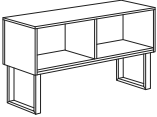
- ① Model Number
- ② Laminate Color (see page 38)
  - a.) Chassis Color
  - b.) Door Color
- ③ Metal Color - Black Sandtex (BSX) or Stardust Silver (STS) (see page 47)
- ④ Other Product Options (see page 39)

When ordering Quickship products, place a "Q" in front of model number.  
 Example: QVL3072DD

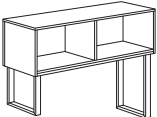


Description	D	W	H	CTN WT	CU FT	① Model	List Price
<b>37" h Post Support Open Overhead Cabinet</b> 	16	72	37	184	16	<b>VL1672PSO-37</b>	\$1,322
	16	66	37	172	15	<b>VL1666PSO-37</b>	\$1,297
	16	60	37	163	13	<b>VL1660PSO-37</b>	\$1,278
	16	54	37	160	12	<b>VL1654PSO-37</b>	\$1,182
	16	48	37	151	11	<b>VL1648PSO-37</b>	\$1,110
	16	42	37	140	10	<b>VL1642PSO-37</b>	\$881
	16	36	37	132	9	<b>VL1636PSO-37</b>	\$790
	16	30	37	127	8	<b>VL1630PSO-37</b>	\$783

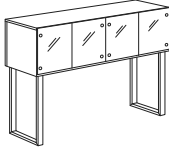
- 21 13/16" vertical clearance
- post support legs to be field installed

<b>27" h Post Support Open Overhead Cabinet</b> 	16	72	27	184	16	<b>VL1672PSO-27</b>	\$1,322
	16	66	27	172	15	<b>VL1666PSO-27</b>	\$1,297
	16	60	27	163	13	<b>VL1660PSO-27</b>	\$1,278
	16	54	27	160	12	<b>VL1654PSO-27</b>	\$1,182
	16	48	27	151	11	<b>VL1648PSO-27</b>	\$1,110
	16	42	27	140	10	<b>VL1642PSO-27</b>	\$881
	16	36	27	132	9	<b>VL1636PSO-27</b>	\$790
	16	30	27	127	8	<b>VL1630PSO-27</b>	\$783

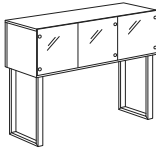
- 12 1/8" vertical clearance
- post support legs to be field installed

<b>Split Height Post Support Open Overhead Cabinet</b> 	16	72	27	184	16	<b>VL1672PSO-2737</b>	\$1,322
	16	66	27	172	15	<b>VL1666PSO-2737</b>	\$1,297
	16	60	27	163	13	<b>VL1660PSO-2737</b>	\$1,278
	16	54	27	160	12	<b>VL1654PSO-2737</b>	\$1,182
	16	48	27	151	11	<b>VL1648PSO-2737</b>	\$1,110
	16	42	27	140	10	<b>VL1642PSO-2737</b>	\$881
	16	36	27	132	9	<b>VL1636PSO-2737</b>	\$790
	16	30	27	127	8	<b>VL1630PSO-2737</b>	\$783


- 12 1/8" - 21 13/16" vertical clearance
- see page 55 for application of split height post support overhead
- post support legs to be field installed

Description	D	W	H	CTN WT	CU FT	① Model	Frameless List Price	Aluminum Frame List Price
<b>37" h Post Support Overhead Cabinet with Four Glass Doors</b> 	16	72	37	192	16	<b>VL1672PSGHD-37</b>	\$1,592	\$2,152
	16	66	37	179	15	<b>VL1666PSGHD-37</b>	\$1,569	\$2,114
	16	60	37	168	13	<b>VL1660PSGHD-37</b>	\$1,547	\$2,075
	16	54	37	165	12	<b>VL1654PSGHD-37</b>	\$1,453	\$1,965

- select Frosted Frameless, Frosted with Aluminum Frame or White Back Painted with Aluminum Frame
- 21 13/16" vertical clearance
- post support legs to be field installed
- locking doors not available
- pulls not available

<b>37" h Post Support Overhead Cabinet with Three Glass Doors</b> 	16	48	37	155	11	<b>VL1648PSGHDR-37</b>	\$1,357	\$1,762
	16	48	37	155	11	<b>VL1648PSGHDL-37</b>	\$1,357	\$1,762
	16	42	37	144	10	<b>VL1642PSGHDR-37</b>	\$1,095	\$1,484
	16	42	37	144	10	<b>VL1642PSGHDL-37</b>	\$1,095	\$1,484

- select Frosted Frameless, Frosted with Aluminum Frame or White Back Painted with Aluminum Frame
- 21 13/16" vertical clearance
- right door configuration - 1 door hinges left and 2 doors hinge right
- left door configuration - 1 door hinges right and 2 doors hinge left
- post support legs to be field installed
- locking doors not available
- pulls not available

<b>37" h Post Support Overhead Cabinet with Two Glass Doors</b> 	16	36	37	135	9	<b>VL1636PSGHD-37</b>	\$1,002	\$1,283
	16	30	37	130	8	<b>VL1630PSGHD-37</b>	\$998	\$1,263

- select Frosted Frameless, Frosted with Aluminum Frame or White Back Painted with Aluminum Frame
- 21 13/16" vertical clearance
- post support legs to be field installed
- locking doors not available
- pulls not available

**To Order, Specify:**

- ① Model Number
- ② Laminate Color (see page 38)
- ③ Glass Option/Color (see page 47)
- ④ Metal Color - Black Sandtex (BSX) or Stardust Silver (STS) (see page 47)
- ⑤ Other Product Options (see page 39)

When ordering Quickship products, place a "Q" in front of model number.  
 Example: QVL3072DD



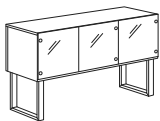


Description	D	W	H	CTN WT	CU FT	① Model	Frameless List Price	Aluminum Frame List Price
27" h Post Support Overhead Cabinet with Four Glass Doors	16	72	27	192	16	VL1672PSGHD-27	\$1,592	\$2,152
	16	66	27	179	15	VL1666PSGHD-27	\$1,569	\$2,114
	16	60	27	168	13	VL1660PSGHD-27	\$1,547	\$2,075
	16	54	27	165	12	VL1654PSGHD-27	\$1,453	\$1,965



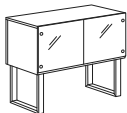
- select Frosted Frameless, Frosted with Aluminum Frame or White Back Painted with Aluminum Frame
- 12 1/8" vertical clearance
- post support legs to be field installed
- locking doors not available
- pulls not available

27" h Post Support Overhead Cabinet with Three Glass Doors	16	48	27	155	11	VL1648PSGHDR-27	\$1,357	\$1,762
	16	48	27	155	11	VL1648PSGHDL-27	\$1,357	\$1,762
	16	42	27	144	10	VL1642PSGHDR-27	\$1,095	\$1,484
	16	42	27	144	10	VL1642PSGHDL-27	\$1,095	\$1,484



- select Frosted Frameless, Frosted with Aluminum Frame or White Back Painted with Aluminum Frame
- 12 1/8" vertical clearance
- right door configuration - 1 door hinges left and 2 doors hinge right
- left door configuration - 1 door hinges right and 2 doors hinge left
- post support legs to be field installed
- locking doors not available
- pulls not available

27" h Post Support Overhead Cabinet with Two Glass Doors	16	36	27	135	9	VL1636PSGHD-27	\$1,002	\$1,283
	16	30	27	130	8	VL1630PSGHD-27	\$998	\$1,263



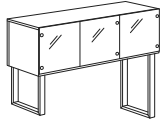
- select Frosted Frameless, Frosted with Aluminum Frame or White Back Painted with Aluminum Frame
- 12 1/8" vertical clearance
- post support legs to be field installed
- locking doors not available
- pulls not available

Description	D	W	H	CTN WT	CU FT	① Model	Frameless List Price	Aluminum Frame List Price
Split Height Post Support Overhead Cabinet with Four Glass Doors	16	72	37	192	16	VL1672PSGHD-2737	\$1,592	\$2,152
	16	66	37	179	15	VL1666PSGHD-2737	\$1,569	\$2,114
	16	60	37	168	13	VL1660PSGHD-2737	\$1,547	\$2,075
	16	54	37	165	12	VL1654PSGHD-2737	\$1,453	\$1,965



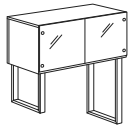
- select Frosted Frameless, Frosted with Aluminum Frame or White Back Painted with Aluminum Frame
- 12 1/8" - 21 13/16" vertical clearance
- see page 55 for application of split height post support overhead
- post support legs to be field installed
- locking doors not available
- pulls not available

Split Height Post Support Overhead Cabinet with Three Glass Doors	16	48	37	155	11	VL1648PSGHDR-2737	\$1,357	\$1,762
	16	48	37	155	11	VL1648PSGHDL-2737	\$1,357	\$1,762
	16	42	37	144	10	VL1642PSGHDR-2737	\$1,095	\$1,484
	16	42	37	144	10	VL1642PSGHDL-2737	\$1,095	\$1,484



- select Frosted Frameless, Frosted with Aluminum Frame or White Back Painted with Aluminum Frame
- 12 1/8" - 21 13/16" vertical clearance
- see page 55 for application of split height post support overhead
- right door configuration - 1 door hinges left and 2 doors hinge right
- left door configuration - 1 door hinges right and 2 doors hinge left
- post support legs to be field installed
- locking doors not available
- pulls not available

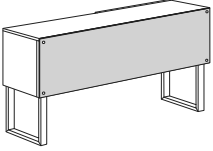
Split Height Post Support Overhead Cabinet with Two Glass Doors	16	36	37	135	9	VL1636PSGHD-2737	\$1,002	\$1,283
	16	30	37	130	8	VL1630PSGHD-2737	\$998	\$1,263

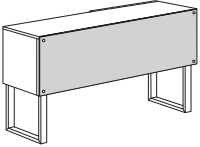


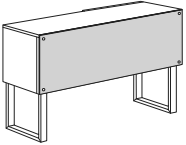
- select Frosted Frameless, Frosted with Aluminum Frame or White Back Painted with Aluminum Frame
- 12 1/8" - 21 13/16" vertical clearance
- see page 55 for application of split height post support overhead
- post support legs to be field installed
- locking doors not available
- pulls not available

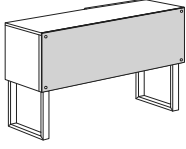
**To Order, Specify:**

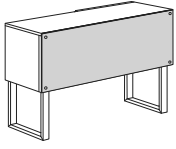
- ① Model Number
- ② Laminate Color (see page 38)
- ③ Glass Option/Color (see page 47)
- ④ Metal Color - Black Sandtex (BSX) or Stardust Silver (STS) (see page 47)
- ⑤ Other Product Options (see page 39)

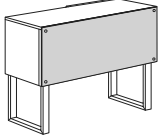
Description	D	W	H	CTN WT	CU FT	① Model	List Price Per Grade
<b>Tackboard for Back of 72" w Post Support Overhead Cabinet</b>  <p><b>NOW!</b></p> <ul style="list-style-type: none"> <li>· for use with 72" wide storage overhead cabinet</li> <li>· Culp Montgomery Sterling panel fabric standard, use Grade A pricing</li> <li>· other fabrics available, contact Customer Service</li> <li>· attaches with covered button screws</li> <li>· ships attached when ordered with overhead cabinets</li> <li>· com ydg: 2 1/4</li> </ul>	3/8	72	15	8	6	<b>VS1572TK</b>	<b>COM</b> \$272
	A	\$296					
	B	\$339					
	C	\$416					
	D	\$515					
	E	\$614					
	F	\$768					
	G	\$933					
	H	\$1,108					
	I	\$1,383					
J	\$1,713						

<b>Tackboard for Back of 66" w Post Support Overhead Cabinet</b>  <p><b>NOW!</b></p> <ul style="list-style-type: none"> <li>· for use with 66" wide storage overhead cabinet</li> <li>· Culp Montgomery Sterling panel fabric standard, use Grade A pricing</li> <li>· other fabrics available, contact Customer Service</li> <li>· attaches with covered button screws</li> <li>· ships attached when ordered with overhead cabinets</li> <li>· com ydg: 2</li> </ul>	3/8	66	15	8	6	<b>VS1566TK</b>	<b>COM</b> \$255
	A	\$275					
	B	\$313					
	C	\$383					
	D	\$470					
	E	\$558					
	F	\$695					
	G	\$842					
	H	\$998					
	I	\$1,243					
J	\$1,536						

<b>Tackboard for Back of 60" w Post Support Overhead Cabinet</b>  <p><b>NOW!</b></p> <ul style="list-style-type: none"> <li>· for use with 60" wide storage overhead cabinet</li> <li>· Culp Montgomery Sterling panel fabric standard, use Grade A pricing</li> <li>· other fabrics available, contact Customer Service</li> <li>· attaches with covered button screws</li> <li>· ships attached when ordered with overhead cabinets</li> <li>· com ydg: 2</li> </ul>	3/8	60	15	7	5	<b>VS1560TK</b>	<b>COM</b> \$249
	A	\$269					
	B	\$308					
	C	\$377					
	D	\$465					
	E	\$553					
	F	\$689					
	G	\$836					
	H	\$993					
	I	\$1,237					
J	\$1,530						

Description	D	W	H	CTN WT	CU FT	① Model	List Price Per Grade
<b>Tackboard for Back of 54" w Post Support Overhead Cabinet</b>	3/8	54	15	7	5	<b>VS1554TK</b>	<b>COM \$231</b>
 <ul style="list-style-type: none"> <li>· for use with 54" wide storage overhead cabinet</li> <li>· Culp Montgomery Sterling panel fabric standard, use Grade A pricing</li> <li>· other fabrics available, contact Customer Service</li> <li>· attaches with covered button screws</li> <li>· ships attached when ordered with overhead cabinets</li> <li>· com ydg: 1 3/4</li> </ul>	A						\$249
	B						\$283
	C						\$343
	D						\$420
	E						\$497
	F						\$617
	G						\$745
	H						\$882
	I						\$1,096
	J						\$1,352

<b>Tackboard for Back of 48" w Post Support Overhead Cabinet</b>	3/8	48	15	7	4	<b>VS1548TK</b>	<b>COM \$227</b>
 <ul style="list-style-type: none"> <li>· for use with 72" wide storage overhead cabinet</li> <li>· Culp Montgomery Sterling panel fabric standard, use Grade A pricing</li> <li>· other fabrics available, contact Customer Service</li> <li>· attaches with covered button screws</li> <li>· ships attached when ordered with overhead cabinets</li> <li>· com ydg: 1 3/4</li> </ul>	A						\$245
	B						\$279
	C						\$339
	D						\$416
	E						\$493
	F						\$613
	G						\$741
	H						\$878
	I						\$1,091
	J						\$1,348

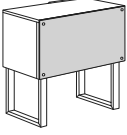
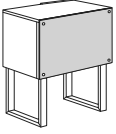
<b>Tackboard for Back of 42" w Post Support Overhead Cabinet</b>	3/8	42	15	6	4	<b>VS1542TK</b>	<b>COM \$209</b>
 <ul style="list-style-type: none"> <li>· for use with 42" wide storage overhead cabinet</li> <li>· Culp Montgomery Sterling panel fabric standard, use Grade A pricing</li> <li>· other fabrics available, contact Customer Service</li> <li>· attaches with covered button screws</li> <li>· ships attached when ordered with overhead cabinets</li> <li>· com ydg: 1 1/2</li> </ul>	A						\$225
	B						\$254
	C						\$305
	D						\$371
	E						\$437
	F						\$540
	G						\$649
	H						\$767
	I						\$951
	J						\$1,170

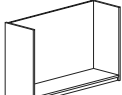
**To Order, Specify:**

- ① Model Number
- ② Fabric Selection: vendor, pattern, color

When ordering Quickship products, place a "Q" in front of model number.  
Example: QVL3072DD

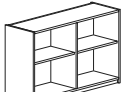
**NOW!**  
Need it.  
JSI Quickship

Description	D	W	H	CTN WT	CU FT	① Model	List Price Per Grade
<b>Tackboard for Back of 36" w Post Support Overhead Cabinet</b>  <p><b>NOW!</b></p> <ul style="list-style-type: none"> <li>· for use with 36" wide storage overhead cabinet</li> <li>· Culp Montgomery Sterling panel fabric standard, use Grade A pricing</li> <li>· other fabrics available, contact Customer Service</li> <li>· attaches with covered button screws</li> <li>· ships attached when ordered with overhead cabinets</li> <li>· com ydg: 1 1/4</li> </ul>	3/8	36	15	5	3	<b>VS1536TK</b>	<b>COM</b> \$188
	A	\$201					
	B	\$225					
	C	\$268					
	D	\$324					
	E	\$378					
	F	\$464					
	G	\$556					
	H	\$654					
	I	\$806					
J	\$990						
<b>Tackboard for Back of 30" w Post Support Overhead Cabinet</b>  <p><b>NOW!</b></p> <ul style="list-style-type: none"> <li>· for use with 30" wide storage overhead cabinet</li> <li>· Culp Montgomery Sterling panel fabric standard, use Grade A pricing</li> <li>· other fabrics available, contact Customer Service</li> <li>· attaches with covered button screws</li> <li>· ships attached when ordered with overhead cabinets</li> <li>· com ydg: 1 1/4</li> </ul>	3/8	30	15	5	2	<b>VS1530TK</b>	<b>COM</b> \$168
	A	\$181					
	B	\$205					
	C	\$248					
	D	\$304					
	E	\$359					
	F	\$444					
	G	\$536					
	H	\$634					
	I	\$786					
J	\$970						

Description	D	W	H	CTN WT	CU FT	① Model	List Price
<b>Double Height Wall Mount Overhead Shelf</b> 	15 7/16	54	30	85	19	VL1554WDTS	\$586
	15 7/16	48	30	76	17	VL1548WDTS	\$512
	15 7/16	42	30	67	15	VL1542WDTS	\$465
	15 7/16	36	30	58	13	VL1536WDTS	\$396
	15 7/16	30	30	55	11	VL1530WDTS	\$394

**NOW!**

· supported by wall cleat - hardware provided by installer

<b>Double Height Wall Mount Open Overhead</b> 	15 7/16	54	30	95	19	VL1554DW00	\$800
	15 7/16	48	30	89	17	VL1548DW00	\$727
	15 7/16	42	30	80	15	VL1542DW00	\$662
	15 7/16	36	30	69	13	VL1536DW00	\$603
	15 7/16	30	30	60	11	VL1530DW00	\$546

**NOW!**

· supported by wall cleat - hardware provided by installer


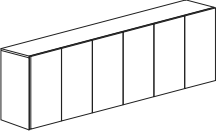
VISION - LAMINATE

**To Order, Specify:**


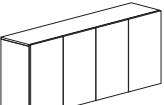
- ① Model Number
- ② Laminate Color (see page 38)
- ③ Fabric Selection: vendor, pattern, color
- ④ Other Product Options (see page 39)

When ordering Quickship products, place a "Q" in front of model number.  
Example: QVL3072DD


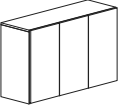
**NOW!**  
*Need it.*  
JSI Quickship

Description	D	W	H	CTN WT	CU FT	① Model	List Price
<b>Double Height Wall Mount Overhead Cabinet with Six Doors</b>  	16	108	30	366	37	VL16108WDSO	\$1,999
	16	102	30	346	35	VL16102WDSO	\$1,897
	16	96	30	325	33	VL1696WDSO	\$1,794
	16	90	30	306	31	VL1690WDSO	\$1,698


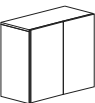
- supported by wall cleat - hardware provided by installer
- locking doors available, specify and add \$315 list
- no pulls

<b>Double Height Wall Mount Overhead Cabinet with Four Doors</b>  	16	84	30	285	29	VL1684WDSO	\$1,607
	16	78	30	264	27	VL1678WDSO	\$1,572
	16	72	30	244	25	VL1672WDSO	\$1,488
	16	66	30	227	23	VL1666WDSO	\$1,409
	16	60	30	212	21	VL1660WDSO	\$1,343
	16	54	30	208	19	VL1654WDSO	\$1,263

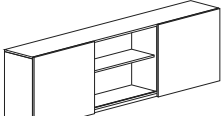
- supported by wall cleat - hardware provided by installer
- locking doors available, specify and add \$210 list
- no pulls

<b>Double Height Wall Mount Overhead Cabinet with Three Doors</b>  	16	48	30	201	17	VL1648WDSOR	\$1,082
	16	48	30	201	17	VL1648WDSOL	\$1,082
	16	42	30	185	15	VL1642WDSOR	\$1,028
	16	42	30	185	15	VL1642WDSOL	\$1,028

- supported by wall cleat - hardware provided by installer
- locking doors available, specify and add \$210 list
- right door configuration - 1 door hinges left and 2 doors hinge right
- left door configuration - 1 door hinges right and 2 doors hinge left
- no pulls

<b>Double Height Wall Mount Overhead Cabinet with Two Doors</b>  	16	36	30	173	13	VL1636WDSO	\$894
	16	30	30	167	11	VL1630WDSO	\$851

- supported by wall cleat - hardware provided by installer
- locking doors available, specify and add \$105 list
- no pulls

Description	D	W	H	CTN WT	CU FT	① Model	List Price
<b>Double Height Wall Mount Overhead Cabinet with Two Sliding Doors</b> 	16	108	30	366	37	VL16108WSDSD	\$2,282
	16	102	30	346	35	VL16102WSDSD	\$2,170
	16	96	30	325	33	VL1696WSDSD	\$2,109
	16	90	30	306	31	VL1690WSDSD	\$2,006

- supported by wall cleat - hardware provided by installer
- white markerboard doors available, specify and add \$431 list
- locking doors not available

<b>Double Height Wall Mount Overhead Cabinet with Sliding Door</b> 	16	84	30	285	29	VL1684WSDSD	\$1,908
	16	78	30	264	27	VL1678WSDSD	\$1,814
	16	72	30	244	25	VL1672WSDSD	\$1,727
	16	66	30	227	23	VL1666WSDSD	\$1,642
	16	60	30	212	21	VL1660WSDSD	\$1,574
	16	54	30	208	19	VL1654WSDSD	\$1,504
	16	48	30	201	17	VL1648WSDSD	\$1,328
	16	42	30	185	15	VL1642WSDSD	\$1,272
	16	36	30	173	13	VL1636WSDSD	\$1,220
	16	30	30	167	11	VL1630WSDSD	\$1,205

- supported by wall cleat - hardware provided by installer
- white markerboard doors available, specify and add \$216 list
- locking doors not available

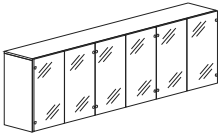
**To Order, Specify:**

- ① Model Number
- ② Laminate Color (see page 38)
  - a.) Chassis Color
  - b.) Door Color
- ③ Other Product Options (see page 39)

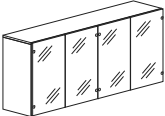
When ordering Quickship products, place a "Q" in front of model number.  
 Example: QVL3072DD






Description	D	W	H	CTN WT	CU FT	① Model	Frameless List Price	Aluminum Frame List Price
<b>Double Height Wall Mount Overhead Cabinet with Six Glass Doors</b> 	16	108	30	366	37	VL16108WDGSO	\$2,624	\$3,688
	16	102	30	346	35	VL16102WDGSO	\$2,495	\$3,543
	16	96	30	325	33	VL1696WDGSO	\$2,375	\$3,404
	16	90	30	306	31	VL1690WDGSO	\$2,256	\$3,267


- select Frosted Frameless, Frosted with Aluminum Frame or White Back Painted with Aluminum Frame
- supported by wall cleat - hardware provided by installer
- locking doors not available
- pulls not available

<b>Double Height Wall Mount Overhead Cabinet with Four Glass Doors</b> 	16	84	30	285	29	VL1684WDGSO	\$2,145	\$2,890
	16	78	30	264	27	VL1678WDGSO	\$2,037	\$2,765
	16	72	30	244	25	VL1672WDGSO	\$1,937	\$2,645
	16	66	30	227	23	VL1666WDGSO	\$1,833	\$2,526
	16	60	30	212	21	VL1660WDGSO	\$1,762	\$2,436
	16	54	30	208	19	VL1654WDGSO	\$1,547	\$2,204

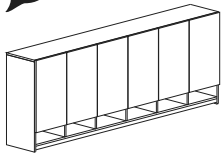
- select Frosted Frameless, Frosted with Aluminum Frame or White Back Painted with Aluminum Frame
- supported by wall cleat - hardware provided by installer
- locking doors not available
- pulls not available

<b>Double Height Wall Mount Overhead Cabinet with Three Glass Doors</b> 	16	48	30	201	17	VL1648WDGSOR	\$1,478	\$1,993
	16	48	30	201	17	VL1648WDGSOL	\$1,478	\$1,993
	16	42	30	185	15	VL1642WDGSOR	\$1,411	\$1,907
	16	42	30	185	15	VL1642WDGSOL	\$1,411	\$1,907

- select Frosted Frameless, Frosted with Aluminum Frame or White Back Painted with Aluminum Frame
- supported by wall cleat - hardware provided by installer
- right door configuration - 1 door hinges left and 2 doors hinge right
- left door configuration - 1 door hinges right and 2 doors hinge left
- locking doors not available
- pulls not available

<b>Double Height Wall Mount Overhead Cabinet with Two Glass Doors</b> 	16	36	30	173	13	VL1636WDGSO	\$1,230	\$1,585
	16	30	30	167	11	VL1630WDGSO	\$1,175	\$1,512

- select Frosted Frameless, Frosted with Aluminum Frame or White Back Painted with Aluminum Frame
- supported by wall cleat - hardware provided by installer
- locking doors not available
- pulls not available

Description	D	W	H	CTN WT	CU FT	① Model	List Price
<b>Double Height Wall Mount Overhead Cabinet with Six Doors and Cubbies</b> 	16	108	36	411	44	VL16108WDSOC	\$2,321
	16	102	36	389	42	VL16102WDSOC	\$2,208
	16	96	36	365	39	VL1696WDSOC	\$2,099
	16	90	36	344	37	VL1690WDSOC	\$1,997

**NOW!**

- supported by wall cleat - hardware provided by installer
- locking doors available, specify and add \$315 list
- no pulls

<b>Double Height Wall Mount Overhead Cabinet with Four Doors and Cubbies</b> 	16	84	36	320	35	VL1684WDSOC	\$1,899
	16	78	36	297	32	VL1678WDSOC	\$1,865
	16	72	36	274	30	VL1672WDSOC	\$1,773
	16	66	36	255	27	VL1666WDSOC	\$1,678
	16	60	36	237	25	VL1660WDSOC	\$1,614
	16	54	36	231	23	VL1654WDSOC	\$1,523

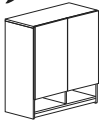
**NOW!**

- supported by wall cleat - hardware provided by installer
- locking doors available, specify and add \$210 list
- no pulls

<b>Double Height Wall Mount Overhead Cabinet with Three Doors and Cubbies</b> 	16	48	36	221	20	VL1648WDSOCR	\$1,310
	16	48	36	221	20	VL1648WDSOCL	\$1,310
	16	42	36	203	18	VL1642WDSOCR	\$1,250
	16	42	36	203	18	VL1642WDSOCL	\$1,250

**NOW!**

- supported by wall cleat - hardware provided by installer
- locking doors available, specify and add \$210 list
- right door configuration - 1 door hinges left and 2 doors hinge right
- left door configuration - 1 door hinges right and 2 doors hinge left
- no pulls

<b>Double Height Wall Mount Overhead Cabinet with Two Doors and Cubbies</b> 	16	36	36	188	16	VL1636WDSOC	\$1,091
	16	30	36	180	13	VL1630WDSOC	\$1,043

**NOW!**

- supported by wall cleat - hardware provided by installer
- locking doors available, specify and add \$105 list
- no pulls

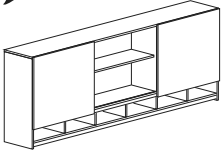
**To Order, Specify:**

- ① Model Number
- ② Laminate Color (see page 38)
  - a.) Chassis Color
  - b.) Door Color
- ③ Glass Option/Color (see page 47)
- ④ Other Product Options (see page 39)

When ordering Quickship products, place a "Q" in front of model number.  
Example: QVL3072DD

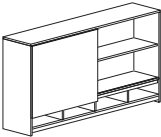
**NOW!**  
Need it.  
JSI Quickship

Description	D	W	H	CTN WT	CU FT	① Model	List Price
Double Height Wall Mount Overhead Cabinet with Two Sliding Doors and Cubbies	16	108	36	411	44	VL16108WSDC	\$2,625
	16	102	36	389	42	VL16102WSDC	\$2,507
	16	96	36	365	39	VL1696WSDC	\$2,448
	16	90	36	344	37	VL1690WSDC	\$2,339



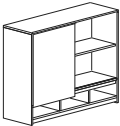
- supported by wall cleat - hardware provided by installer
- white markerboard doors available, specify and add \$431 list
- locking doors not available
- pulls not available

Double Height Wall Mount Overhead Cabinet with Sliding Door and Cubbies	16	84	36	320	35	VL1684WSDC	\$2,234
	16	78	36	297	32	VL1678WSDC	\$2,134
	16	72	36	274	30	VL1672WSDC	\$2,039
	16	66	36	255	27	VL1666WSDC	\$1,937
	16	60	36	237	25	VL1660WSDC	\$1,874
	16	54	36	231	23	VL1654WSDC	\$1,799

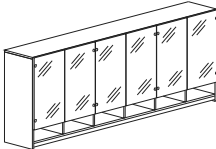
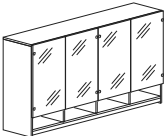
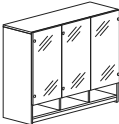



- supported by wall cleat - hardware provided by installer
- white markerboard doors available, specify and add \$216 list
- locking doors not available
- pulls not available

Double Height Wall Mount Overhead Cabinet with Sliding Door and Cubbies	16	48	36	221	20	VL1648WSDC	\$1,594
	16	42	36	203	18	VL1642WSDC	\$1,533
	16	36	36	188	16	VL1636WSDC	\$1,476
	16	30	36	180	13	VL1630WSDC	\$1,465



- supported by wall cleat - hardware provided by installer
- white markerboard doors available, specify and add \$216 list
- locking doors not available
- pulls not available

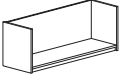
Description	D	W	H	CTN WT	CU FT	① Model	Frameless List Price	Aluminum Frame List Price
<b>Double Height Wall Mount Overhead Cabinet with Six Glass Doors and Cubbies</b> 	16	108	36	411	44	VL16108WDGSOC	\$2,985	\$4,048
	16	102	36	389	42	VL16102WDGSOC	\$2,848	\$3,896
	16	96	36	365	39	VL1696WDGSOC	\$2,721	\$3,750
	16	90	36	344	37	VL1690WDGSOC	\$2,597	\$3,608
								<ul style="list-style-type: none"> <li>• select Frosted Frameless, Frosted with Aluminum Frame or White Back Painted with Aluminum Frame</li> <li>• supported by wall cleat - hardware provided by installer</li> <li>• locking doors not available</li> <li>• pulls not available</li> </ul>
<b>Double Height Wall Mount Overhead Cabinet with Four Glass Doors and Cubbies</b> 	16	84	36	320	35	VL1684WDGSOC	\$2,481	\$3,226
	16	78	36	297	32	VL1678WDGSOC	\$2,367	\$3,095
	16	72	36	274	30	VL1672WDGSOC	\$2,258	\$2,967
	16	66	36	255	27	VL1666WDGSOC	\$2,137	\$2,830
	16	60	36	237	25	VL1660WDGSOC	\$1,949	\$2,623
	16	54	36	231	23	VL1654WDGSOC	\$1,867	\$2,525
								<ul style="list-style-type: none"> <li>• select Frosted Frameless, Frosted with Aluminum Frame or White Back Painted with Aluminum Frame</li> <li>• supported by wall cleat - hardware provided by installer</li> <li>• locking doors not available</li> <li>• pulls not available</li> </ul>
<b>Double Height Wall Mount Overhead Cabinet with Three Glass Doors and Cubbies</b> 	16	48	36	221	20	VL1648WDGSOCR	\$1,789	\$2,304
	16	48	36	221	20	VL1648WDGSOCL	\$1,789	\$2,304
	16	42	36	203	18	VL1642WDGSOCR	\$1,685	\$2,181
	16	42	36	203	18	VL1642WDGSOCL	\$1,685	\$2,181
								<ul style="list-style-type: none"> <li>• select Frosted Frameless, Frosted with Aluminum Frame or White Back Painted with Aluminum Frame</li> <li>• supported by wall cleat - hardware provided by installer</li> <li>• right door configuration - 1 door hinges left and 2 doors hinge right</li> <li>• left door configuration - 1 door hinges right and 2 doors hinge left</li> <li>• locking doors not available</li> <li>• pulls not available</li> </ul>
<b>Double Height Wall Mount Overhead Cabinet with Two Glass Doors and Cubbies</b> 	16	36	36	188	16	VL1636WDGSOC	\$1,409	\$1,763
	16	30	36	180	13	VL1630WDGSOC	\$1,352	\$1,689
								<ul style="list-style-type: none"> <li>• select Frosted Frameless, Frosted with Aluminum Frame or White Back Painted with Aluminum Frame</li> <li>• supported by wall cleat - hardware provided by installer</li> <li>• locking doors not available</li> <li>• pulls not available</li> </ul>

**To Order, Specify:**

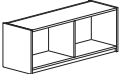
- ① Model Number
- ② Laminate Color (see page 38)
  - a.) Chassis Color
  - b.) Door Color
- ③ Glass Option/Color (see page 47)
- ④ Other Product Options (see page 39)

When ordering Quickship products, place a "Q" in front of model number.  
 Example: QVL3072DD

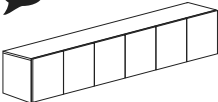


Description	D	W	H	CTN WT	CU FT	① Model	List Price
<b>Wall Mount Overhead Shelf</b> 	15 7/16	54	18	65	12	VL1554WTS	\$533
	15 7/16	48	18	58	10	VL1548WTS	\$466
	15 7/16	42	18	51	9	VL1542WTS	\$423
	15 7/16	36	18	44	8	VL1536WTS	\$361
	15 7/16	30	18	42	7	VL1530WTS	\$359

· supported by wall cleat - hardware provided by installer

<b>Wall Mount Open Overhead</b> 	15 7/16	54	18	73	12	VL1554W00	\$727
	15 7/16	48	18	68	10	VL1548W00	\$661
	15 7/16	42	18	61	9	VL1542W00	\$602
	15 7/16	36	18	53	8	VL1536W00	\$549
	15 7/16	30	18	46	7	VL1530W00	\$497

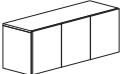
· supported by wall cleat - hardware provided by installer  
 · no center divider in 36" and 30" wide units ▲

<b>Wall Mount Overhead Cabinet with Six Doors</b> 	16	108	18	281	23	VL16108WSO	\$1,592
	16	102	18	266	22	VL16102WSO	\$1,502
	16	96	18	250	21	VL1696WSO	\$1,417
	16	90	18	235	20	VL1690WSO	\$1,336


· supported by wall cleat - hardware provided by installer  
 · locking doors available, specify and add \$315 list  
 · no pulls

<b>Wall Mount Overhead Cabinet with Four Doors</b> 	16	84	18	219	18	VL1684WSO	\$1,259
	16	78	18	203	17	VL1678WSO	\$1,188
	16	72	18	187	16	VL1672WSO	\$1,149
	16	66	18	174	15	VL1666WSO	\$1,063
	16	60	18	163	13	VL1660WSO	\$974
	16	54	18	160	12	VL1654WSO	\$921

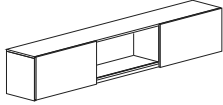
· supported by wall cleat - hardware provided by installer  
 · locking doors available, specify and add \$210 list  
 · no pulls

<b>Wall Mount Overhead Cabinet with Three Doors</b> 	16	48	18	154	11	VL1648WSOR	\$845
	16	48	18	154	11	VL1648WSOL	\$845
	16	42	18	142	10	VL1642WSOR	\$800
	16	42	18	142	10	VL1642WSOL	\$800

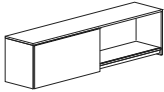
· supported by wall cleat - hardware provided by installer  
 · locking doors available, specify and add \$210 list  
 · right door configuration - 1 door hinges left and 2 doors hinge right  
 · left door configuration - 1 door hinges right and 2 doors hinge left  
 · no pulls

<b>Wall Mount Overhead Cabinet with Two Doors</b> 	16	36	18	133	8	VL1636WSO	\$693
	16	30	18	128	7	VL1630WSO	\$657

· supported by wall cleat - hardware provided by installer  
 · locking doors available, specify and add \$105 list  
 · no pulls

Description	D	W	H	CTN WT	CU FT	① Model	List Price
<b>Wall Mount Overhead Cabinet with Two Sliding Doors</b> 	16	108	18	281	23	VL16108WSD	\$1,880
	16	102	18	266	22	VL16102WSD	\$1,780
	16	96	18	250	21	VL1696WSD	\$1,686
	16	90	18	235	20	VL1690WSD	\$1,598

· supported by wall cleat - hardware provided by installer  
 · white markerboard doors available, specify and add \$326 list  
 · locking doors not available  
 · pulls not available

<b>Wall Mount Overhead Cabinet with Sliding Door</b> 	16	84	18	219	18	VL1684WSD	\$1,514
	16	78	18	203	17	VL1678WSD	\$1,481
	16	72	18	187	16	VL1672WSD	\$1,403
	16	66	18	174	15	VL1666WSD	\$1,334
	16	60	18	163	13	VL1660WSD	\$1,269
	16	54	18	160	12	VL1654WSD	\$1,194
	16	48	18	154	11	VL1648WSD	\$1,024
	16	42	18	142	10	VL1642WSD	\$977
	16	36	18	133	8	VL1636WSD	\$854
	16	30	18	128	7	VL1630WSD	\$840

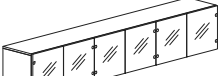
· supported by wall cleat - hardware provided by installer  
 · white markerboard doors available, specify and add \$163 list  
 · locking doors not available  
 · pulls not available

**To Order, Specify:**

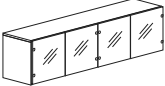
- ① Model Number
- ② Laminate Color (see page 38)
  - a.) Chassis Color
  - b.) Door Color
- ③ Other Product Options (see page 39)

When ordering Quickship products, place a "Q" in front of model number.  
 Example: QVL3072DD



Description	D	W	H	CTN WT	CU FT	① Model	Frameless List Price	Aluminum Frame List Price
Wall Mount Overhead with Six Glass Doors  	16	108	18	281	23	VL16108WGSO	\$2,016	\$2,889
	16	102	18	266	22	VL16102WGSO	\$1,908	\$2,768
	16	96	18	250	21	VL1696WGSO	\$1,809	\$2,649
	16	90	18	235	20	VL1690WGSO	\$1,713	\$2,538

- select Frosted Frameless, Frosted with Aluminum Frame or White Back Painted with Aluminum Frame
- supported by wall cleat - hardware provided by installer
- locking doors not available
- pulls not available

Wall Mount Overhead with Four Glass Doors  	16	84	18	219	18	VL1684WGSO	\$1,622	\$2,238
	16	78	18	203	17	VL1678WGSO	\$1,535	\$2,123
	16	72	18	187	16	VL1672WGSO	\$1,454	\$2,035
	16	66	18	174	15	VL1666WGSO	\$1,308	\$1,875
	16	60	18	163	13	VL1660WGSO	\$1,248	\$1,798
	16	54	18	160	12	VL1654WGSO	\$1,185	\$1,720


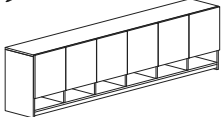
- select Frosted Frameless, Frosted with Aluminum Frame or White Back Painted with Aluminum Frame
- supported by wall cleat - hardware provided by installer
- locking doors not available
- pulls not available

Wall Mount Overhead with Three Glass Doors  	16	48	18	154	11	VL1648WGSOR	\$1,126	\$1,547
	16	48	18	154	11	VL1648WGSOL	\$1,126	\$1,547
	16	42	18	142	10	VL1642WGSOR	\$1,071	\$1,474
	16	42	18	142	10	VL1642WGSOL	\$1,071	\$1,474


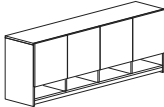
- select Frosted Frameless, Frosted with Aluminum Frame or White Back Painted with Aluminum Frame
- supported by wall cleat - hardware provided by installer
- right door configuration - 1 door hinges left and 2 doors hinge right
- left door configuration - 1 door hinges right and 2 doors hinge left
- locking doors not available
- pulls not available

Wall Mount Overhead with Two Glass Doors  	16	36	18	133	8	VL1636WGSO	\$873	\$1,165
	16	30	18	128	7	VL1630WGSO	\$831	\$1,107


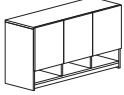
- select Frosted Frameless, Frosted with Aluminum Frame or White Back Painted with Aluminum Frame
- supported by wall cleat - hardware provided by installer
- locking doors not available
- pulls not available

Description	D	W	H	CTN WT	CU FT	① Model	List Price
<b>Wall Mount Overhead Cabinet with Six Doors and Cubbies</b>  	16	108	24	326	30	VL16108WSOC	\$1,935
	16	102	24	309	29	VL16102WSOC	\$1,832
	16	96	24	290	27	VL1696WSOC	\$1,735
	16	90	24	273	25	VL1690WSOC	\$1,643



- supported by wall cleat - hardware provided by installer
- locking doors available, specify and add \$315 list
- no pulls

<b>Wall Mount Overhead Cabinet with Four Doors and Cubbies</b>  	16	84	24	254	24	VL1684WSOC	\$1,556
	16	78	24	236	22	VL1678WSOC	\$1,522
	16	72	24	217	21	VL1672WSOC	\$1,441
	16	66	24	202	19	VL1666WSOC	\$1,364
	16	60	24	188	17	VL1660WSOC	\$1,301
	16	54	24	183	16	VL1654WSOC	\$1,223

- supported by wall cleat - hardware provided by installer
- locking doors available, specify and add \$210 list
- no pulls

<b>Wall Mount Overhead Cabinet with Three Doors and Cubbies</b>  	16	48	24	174	14	VL1648WSOCR	\$1,048
	16	48	24	174	14	VL1648WSOCL	\$1,048
	16	42	24	160	12	VL1642WSOCR	\$996
	16	42	24	160	12	VL1642WSOCL	\$996

- supported by wall cleat - hardware provided by installer
- locking doors available, specify and add \$210 list
- right door configuration - 1 door hinges left and 2 doors hinge right
- left door configuration - 1 door hinges right and 2 doors hinge left
- no pulls

<b>Wall Mount Overhead Cabinet with Two Doors and Cubbies</b>  	16	36	24	148	11	VL1636WSOC	\$867
	16	30	24	141	9	VL1630WSOC	\$825

- supported by wall cleat - hardware provided by installer
- locking doors available, specify and add \$105 list
- no pulls


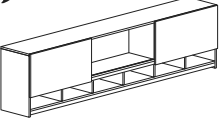
**To Order, Specify:**

- ① Model Number
- ② Laminate Color (see page 38)
  - a.) Chassis Color
  - b.) Door Color
- ③ Glass Option/Color (see page 47)
- ④ Other Product Options (see page 39)


When ordering Quickship products, place a "Q" in front of model number.  
 Example: QVL3072DD

**NOW!**  
 Need it.  
 JSI Quickship


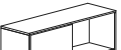


Description	D	W	H	CTN WT	CU FT	① Model	List Price
<b>Wall Mount Overhead Cabinet with Two Sliding Doors and Cubbies</b>  	16	108	24	326	30	VL16108WSDC	\$2,218
	16	102	24	309	29	VL16102WSDC	\$2,110
	16	96	24	290	27	VL1696WSDC	\$2,006
	16	90	24	273	25	VL1690WSDC	\$1,909

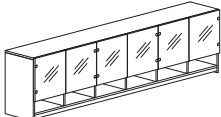
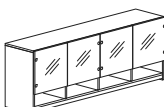
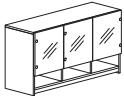

- supported by wall cleat - hardware provided by installer
- white markerboard doors available, specify and add \$326 list
- locking doors not available
- pulls not available

<b>Wall Mount Overhead Cabinet with Sliding Door and Cubbies</b>  	16	84	24	254	24	VL1684WSDC	\$1,816
	16	78	24	236	22	VL1678WSDC	\$1,785
	16	72	24	217	21	VL1672WSDC	\$1,698
	16	66	24	202	19	VL1666WSDC	\$1,614
	16	60	24	188	17	VL1660WSDC	\$1,548
	16	54	24	183	16	VL1654WSDC	\$1,464

- supported by wall cleat - hardware provided by installer
- white markerboard doors available, specify and add \$163 list
- locking doors not available
- pulls not available

<b>Wall Mount Overhead Cabinet with Sliding Door and Cubbies</b>  	16	48	24	174	14	VL1648WSDC	\$1,260
	16	42	24	160	12	VL1642WSDC	\$1,207
	16	36	24	148	11	VL1636WSDC	\$1,059
	16	30	24	141	9	VL1630WSDC	\$1,046

- supported by wall cleat - hardware provided by installer
- white markerboard doors available, specify and add \$163 list
- locking doors not available
- pulls not available


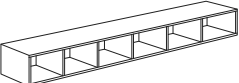
Description	D	W	H	CTN WT	CU FT	① Model	Frameless List Price	Aluminum Frame List Price
<b>Wall Mount Overhead Cabinet with Six Glass Doors and Cubbies</b> 	16	108	24	326	30	VL16108WGSOC	\$2,400	\$3,272
	16	102	24	309	29	VL16102WGSOC	\$2,282	\$3,142
	16	96	24	290	27	VL1696WGSOC	\$2,171	\$3,011
	16	90	24	273	25	VL1690WGSOC	\$2,064	\$2,889
<ul style="list-style-type: none"> <li>· select Frosted Frameless, Frosted with Aluminum Frame or White Back Painted with Aluminum Frame</li> <li>· supported by wall cleat - hardware provided by installer</li> <li>· locking doors not available</li> <li>· pulls not available</li> </ul>								
<b>Wall Mount Overhead Cabinet with Four Glass Doors and Cubbies</b> 	16	84	24	254	24	VL1684WGSOC	\$1,963	\$2,579
	16	78	24	236	22	VL1678WGSOC	\$1,865	\$2,453
	16	72	24	217	21	VL1672WGSOC	\$1,773	\$2,355
	16	66	24	202	19	VL1666WGSOC	\$1,595	\$2,162
	16	60	24	188	17	VL1660WGSOC	\$1,536	\$2,086
	16	54	24	183	16	VL1654WGSOC	\$1,464	\$2,000
<ul style="list-style-type: none"> <li>· select Frosted Frameless, Frosted with Aluminum Frame or White Back Painted with Aluminum Frame</li> <li>· supported by wall cleat - hardware provided by installer</li> <li>· locking doors not available</li> <li>· pulls not available</li> </ul>								
<b>Wall Mount Overhead Cabinet with Three Glass Doors and Cubbies</b> 	16	48	24	174	14	VL1648WGSOCR	\$1,397	\$1,818
	16	48	24	174	14	VL1648WGSOCL	\$1,397	\$1,818
	16	42	24	160	12	VL1642WGSOCR	\$1,334	\$1,736
	16	42	24	160	12	VL1642WGSOCL	\$1,334	\$1,736
<ul style="list-style-type: none"> <li>· select Frosted Frameless, Frosted with Aluminum Frame or White Back Painted with Aluminum Frame</li> <li>· supported by wall cleat - hardware provided by installer</li> <li>· right door configuration - 1 door hinges left and 2 doors hinge right</li> <li>· left door configuration - 1 door hinges right and 2 doors hinge left</li> <li>· locking doors not available</li> <li>· pulls not available</li> </ul>								
<b>Wall Mount Overhead Cabinet with Two Glass Doors and Cubbies</b> 	16	36	24	148	11	VL1636WGSOC	\$1,091	\$1,383
	16	30	24	141	9	VL1630WGSOC	\$1,043	\$1,319
<ul style="list-style-type: none"> <li>· select Frosted Frameless, Frosted with Aluminum Frame or White Back Painted with Aluminum Frame</li> <li>· supported by wall cleat - hardware provided by installer</li> <li>· locking doors not available</li> <li>· pulls not available</li> </ul>								

**To Order, Specify:**


- ① Model Number
- ② Laminate Color (see page 38)
  - a.) Chassis Color
  - b.) Door Color
- ③ Glass Option/Color (see page 47)
- ④ Other Product Options (see page 39)

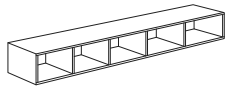
When ordering Quickship products, place a "Q" in front of model number.  
 Example: QVL3072DD





Description	D	W	H	CTN WT	CU FT	① Model	List Price
Wall Mount Cubby	13	108	10	131	12	VL10108WCU	\$1,097
 Wall Mount Cubby	13	102	10	122	11	VL10102WCU	\$1,024
	13	96	10	113	11	VL1096WCU	\$953
	13	90	10	106	10	VL1090WCU	\$887

- 6 compartments
- supported by wall cleat - hardware provided by installer
- VL10108WCU interior dimensions - 11 7/16 d X 17 1/8 w X 8 1/2 h
- VL10102WCU interior dimensions - 11 7/16 d X 16 1/8 w X 8 1/2 h
- VL1096WCU interior dimensions - 11 7/16 d X 15 1/8 w X 8 1/2 h
- VL1090WCU interior dimensions - 11 7/16 d X 14 1/8 w X 8 1/2 h


Wall Mount Cubby	13	84	10	98	9	VL1084WCU	\$815
 Wall Mount Cubby	13	78	10	89	9	VL1078WCU	\$751

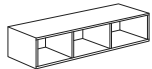


- 5 compartments
- supported by wall cleat - hardware provided by installer
- VL1084WCU interior dimensions - 11 7/16 d X 15 7/8 w X 8 1/2 h
- VL1078WCU interior dimensions - 11 7/16 d X 14 3/4 w X 8 1/2 h



Wall Mount Cubby	13	72	10	81	8	VL1072WCU	\$695
 Wall Mount Cubby	13	66	10	74	8	VL1066WCU	\$637
	13	60	10	68	7	VL1060WCU	\$586

- 4 compartments
- supported by wall cleat - hardware provided by installer
- VL1072WCU interior dimensions - 11 7/16 d X 17 1/16 w X 8 1/2 h
- VL1066WCU interior dimensions - 11 7/16 d X 15 9/16 w X 8 1/2 h
- VL1060WCU interior dimensions - 11 7/16 d X 14 1/16 w X 8 1/2 h

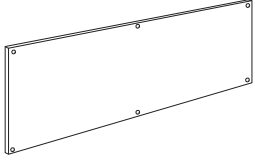
Wall Mount Cubby	13	54	10	62	6	VL1054WCU	\$539
 Wall Mount Cubby	13	48	10	53	6	VL1048WCU	\$498



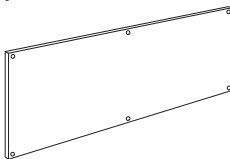
- 3 compartments
- supported by wall cleat - hardware provided by installer
- VL1054WCU interior dimensions - 11 7/16 d X 17 w X 8 1/2 h
- VL1048WCU interior dimensions - 11 7/16 d X 15 w X 8 1/2 h

Wall Mount Cubby	13	42	10	47	5	VL1042WCU	\$456
 Wall Mount Cubby	13	36	10	42	4	VL1036WCU	\$419
	13	30	10	37	4	VL1030WCU	\$386

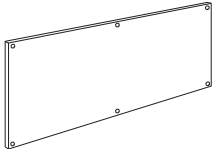
- 2 compartments
- supported by wall cleat - hardware provided by installer
- VL1042WCU interior dimensions - 11 7/16 d X 19 7/8 w X 8 1/2 h
- VL1036WCU interior dimensions - 11 7/16 d X 16 7/8 w X 8 1/2 h
- VL1030WCU interior dimensions - 11 7/16 d X 13 7/8 w X 8 1/2 h

Description	D	W	H	CTN WT	CU FT	① Model	List Price Per Grade
<b>84" w Wall Mount Tackboard for Overhead Cabinet</b> 	7/8	83 3/4	21 1/2	19	8	<b>VS8420WT</b>	<b>COM \$353</b> A \$381 B \$434 C \$529 D \$649 E \$770 F \$959 G \$1,161 H \$1,375 I \$1,711 J \$2,114

- Culp Montgomery Sterling panel fabric standard, use Grade A pricing
- other fabrics available, contact Customer Service
- attaches with covered button screws
- com ydg: 2 3/4

<b>78" w Wall Mount Tackboard for Overhead Cabinet</b> 	7/8	77 3/4	21 1/2	18	7	<b>VS7820WT</b>	<b>COM \$349</b> A \$374 B \$423 C \$509 D \$619 E \$728 F \$899 G \$1,083 H \$1,278 I \$1,584 J \$1,950
---	-----	--------	--------	----	---	-----------------	--

- Culp Montgomery Sterling panel fabric standard, use Grade A pricing
- other fabrics available, contact Customer Service
- attaches with covered button screws
- com ydg: 2 1/2

<b>72" w Wall Mount Tackboard for Overhead Cabinet</b> 	7/8	71 3/4	21 1/2	16	6	<b>VS7220WT</b>	<b>COM \$332</b> A \$355 B \$398 C \$476 D \$575 E \$674 F \$828 G \$993 H \$1,168 I \$1,443 J \$1,773
---	-----	--------	--------	----	---	-----------------	--

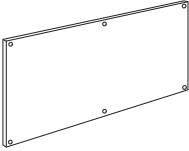
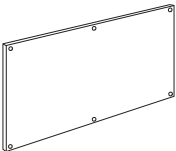
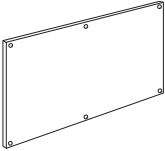
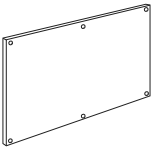
- Culp Montgomery Sterling panel fabric standard, use Grade A pricing
- other fabrics available, contact Customer Service
- attaches with covered button screws
- com ydg: 2 1/4

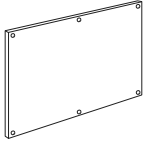
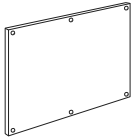
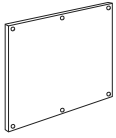
**To Order, Specify:**

- ① Model Number
- ② Laminate Color (see page 38)
- ③ Fabric Selection: vendor, pattern, color
- ④ Other Product Options (see page 39)

When ordering Quickship products, place a "Q" in front of model number.  
 Example: QVL3072DD



Description	D	W	H	CTN WT	CU FT	① Model	List Price Per Grade
<b>66" w Wall Mount Tackboard for Overhead Cabinet</b> 	7/8	65 3/4	21 1/2	15	6	VS6620WT	COM \$313
							A \$333
							B \$372
							C \$441
							D \$529
							E \$617
							F \$753
							G \$900
							H \$1,057
							I \$1,301
J \$1,594							
<ul style="list-style-type: none"> <li>· Culp Montgomery Sterling panel fabric standard, use Grade A pricing</li> <li>· other fabrics available, contact Customer Service</li> <li>· attaches with covered button screws</li> <li>· com ydg: 2</li> </ul>							
<b>60" w Wall Mount Tackboard for Overhead Cabinet</b> 	7/8	59 3/4	21 1/2	14	5	VS6020WT	COM \$309
							A \$329
							B \$368
							C \$437
							D \$524
							E \$613
							F \$749
							G \$896
							H \$1,053
							I \$1,297
J \$1,590							
<ul style="list-style-type: none"> <li>· Culp Montgomery Sterling panel fabric standard, use Grade A pricing</li> <li>· other fabrics available, contact Customer Service</li> <li>· attaches with covered button screws</li> <li>· com ydg: 2</li> </ul>							
<b>54" w Wall Mount Tackboard for Overhead Cabinet</b> 	7/8	53 3/4	21 1/2	13	5	VS5420WT	COM \$291
							A \$309
							B \$343
							C \$403
							D \$480
							E \$557
							F \$677
							G \$805
							H \$942
							I \$1,155
J \$1,412							
<ul style="list-style-type: none"> <li>· Culp Montgomery Sterling panel fabric standard, use Grade A pricing</li> <li>· other fabrics available, contact Customer Service</li> <li>· attaches with covered button screws</li> <li>· com ydg: 1 3/4</li> </ul>							
<b>48" w Wall Mount Tackboard for Overhead Cabinet</b> 	7/8	47 3/4	21 1/2	12	4	VS4820WT	COM \$286
							A \$304
							B \$338
							C \$397
							D \$475
							E \$552
							F \$671
							G \$800
							H \$937
							I \$1,150
J \$1,406							
<ul style="list-style-type: none"> <li>· Culp Montgomery Sterling panel fabric standard, use Grade A pricing</li> <li>· other fabrics available, contact Customer Service</li> <li>· attaches with covered button screws</li> <li>· com ydg: 1 3/4</li> </ul>							

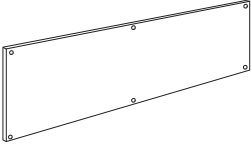
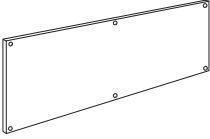
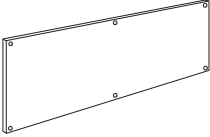
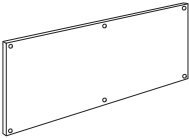
Description	D	W	H	CTN WT	CU FT	① Model	List Price Per Grade
<b>42" w Wall Mount Tackboard for Overhead Cabinet</b> 	7/8	41 3/4	21 1/2	11	4	VS4220WT	COM \$269
							A \$285
							B \$313
							C \$365
							D \$431
							E \$497
							F \$600
							G \$709
							H \$827
							I \$1,011
J \$1,230							
<b>36" w Wall Mount Tackboard for Overhead Cabinet</b> 	7/8	35 3/4	21 1/2	10	3	VS3620WT	COM \$247
							A \$260
							B \$284
							C \$327
							D \$383
							E \$437
							F \$522
							G \$615
							H \$712
							I \$865
J \$1,048							
<b>30" w Wall Mount Tackboard for Overhead Cabinet</b> 	7/8	29 3/4	21 1/2	10	2	VS3020WT	COM \$228
							A \$241
							B \$265
							C \$308
							D \$364
							E \$418
							F \$503
							G \$596
							H \$693
							I \$846
J \$1,029							

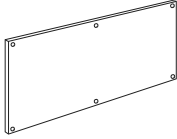
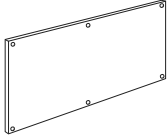
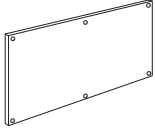
**To Order, Specify:**

- ① Model Number
- ② Fabric Selection: vendor, pattern, color

When ordering Quickship products, place a "Q" in front of model number.  
Example: QVL3072DD



Description	D	W	H	CTN WT	CU FT	① Model	List Price Per Grade
<b>84" w Wall Mount Tackboard for Overhead Cabinet with Cubbies</b> 	7/8	83 3/4	15 1/2	19	8	VS8420WTC	COM \$353
							A \$381
							B \$434
							C \$529
							D \$649
							E \$770
							F \$959
							G \$1,161
							H \$1,375
							I \$1,711
J \$2,114							
<ul style="list-style-type: none"> <li>· Culp Montgomery Sterling panel fabric standard, use Grade A pricing</li> <li>· other fabrics available, contact Customer Service</li> <li>· attaches with covered button screws</li> <li>· com ydg: 2 3/4</li> </ul>							
<b>78" w Wall Mount Tackboard for Overhead Cabinet with Cubbies</b> 	7/8	77 3/4	15 1/2	18	7	VS7820WTC	COM \$349
							A \$374
							B \$423
							C \$509
							D \$619
							E \$728
							F \$899
							G \$1,083
							H \$1,278
							I \$1,584
J \$1,950							
<ul style="list-style-type: none"> <li>· Culp Montgomery Sterling panel fabric standard, use Grade A pricing</li> <li>· other fabrics available, contact Customer Service</li> <li>· attaches with covered button screws</li> <li>· com ydg: 2 1/2</li> </ul>							
<b>72" w Wall Mount Tackboard for Overhead Cabinet with Cubbies</b> 	7/8	71 3/4	15 1/2	16	6	VS7220WTC	COM \$332
							A \$355
							B \$398
							C \$476
							D \$575
							E \$674
							F \$828
							G \$993
							H \$1,168
							I \$1,443
J \$1,773							
<ul style="list-style-type: none"> <li>· Culp Montgomery Sterling panel fabric standard, use Grade A pricing</li> <li>· other fabrics available, contact Customer Service</li> <li>· attaches with covered button screws</li> <li>· com ydg: 2 1/4</li> </ul>							
<b>66" w Wall Mount Tackboard for Overhead Cabinet with Cubbies</b> 	7/8	65 3/4	15 1/2	15	6	VS6620WTC	COM \$313
							A \$333
							B \$372
							C \$441
							D \$529
							E \$617
							F \$753
							G \$900
							H \$1,057
							I \$1,301
J \$1,594							
<ul style="list-style-type: none"> <li>· Culp Montgomery Sterling panel fabric standard, use Grade A pricing</li> <li>· other fabrics available, contact Customer Service</li> <li>· attaches with covered button screws</li> <li>· com ydg: 2</li> </ul>							

Description	D	W	H	CTN WT	CU FT	① Model	List Price Per Grade
<b>60" w Wall Mount Tackboard for Overhead Cabinet with Cubbies</b> 	7/8	59 3/4	15 1/2	14	5	<b>VS6020WTC</b>	<b>COM \$309</b> A \$329 B \$368 C \$437 D \$524 E \$613 F \$749 G \$896 H \$1,053 I \$1,297 J \$1,590
• Culp Montgomery Sterling panel fabric standard, use Grade A pricing • other fabrics available, contact Customer Service • attaches with covered button screws • com ydg: 2							
<b>54" w Wall Mount Tackboard for Overhead Cabinet with Cubbies</b> 	7/8	53 3/4	15 1/2	13	5	<b>VS5420WTC</b>	<b>COM \$291</b> A \$309 B \$343 C \$403 D \$480 E \$557 F \$677 G \$805 H \$942 I \$1,155 J \$1,412
• Culp Montgomery Sterling panel fabric standard, use Grade A pricing • other fabrics available, contact Customer Service • attaches with covered button screws • com ydg: 1 3/4							
<b>48" w Wall Mount Tackboard for Overhead Cabinet with Cubbies</b> 	7/8	47 3/4	15 1/2	12	4	<b>VS4820WTC</b>	<b>COM \$286</b> A \$304 B \$338 C \$397 D \$475 E \$552 F \$671 G \$800 H \$937 I \$1,150 J \$1,406
• Culp Montgomery Sterling panel fabric standard, use Grade A pricing • other fabrics available, contact Customer Service • attaches with covered button screws • com ydg: 1 3/4							

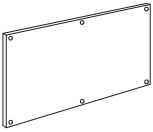
**To Order, Specify:**

- ① Model Number
- ② Fabric Selection: vendor, pattern, color

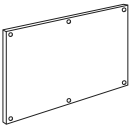
When ordering Quickship products, place a "Q" in front of model number.  
 Example: QVL3072DD



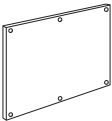


Description	D	W	H	CTN WT	CU FT	① Model	List Price Per Grade
<b>42" w Wall Mount Tackboard for Overhead Cabinet with Cubbies</b> 	7/8	41 3/4	15 1/2	11	4	VS4220WTC	COM \$269
							A \$285
							B \$313
							C \$365
							D \$431
							E \$497
							F \$600
							G \$709
							H \$827
							I \$1,011
J \$1,230							

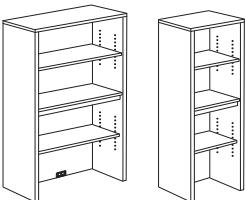
- Culp Montgomery Sterling panel fabric standard, use Grade A pricing
- other fabrics available, contact Customer Service
- attaches with covered button screws
- com ydg: 1 1/2

<b>36" w Wall Mount Tackboard for Overhead Cabinet with Cubbies</b> 	7/8	35 3/4	15 1/2	10	3	VS3620WTC	COM \$247
							A \$260
							B \$284
							C \$327
							D \$383
							E \$437
							F \$522
							G \$615
							H \$712
							I \$865
J \$1,048							

- Culp Montgomery Sterling panel fabric standard, use Grade A pricing
- other fabrics available, contact Customer Service
- attaches with covered button screws
- com ydg: 1 1/4

<b>30" w Wall Mount Tackboard for Overhead Cabinet with Cubbies</b> 	7/8	29 3/4	15 1/2	10	2	VS3020WTC	COM \$228
							A \$241
							B \$265
							C \$308
							D \$364
							E \$418
							F \$503
							G \$596
							H \$693
							I \$846
J \$1,029							

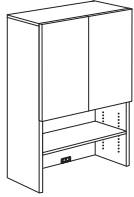
- Culp Montgomery Sterling panel fabric standard, use Grade A pricing
- other fabrics available, contact Customer Service
- attaches with covered button screws
- com ydg: 1 1/4

Description	D	W	H	CTN WT	CU FT	① Model	List Price
<b>Double Height Bookcase Overhead</b> 	15 7/16	36	54	102	22	VL1636DBO	\$917
	15 7/16	30	54	98	19	VL1630DBO	\$836
	15 7/16	18	54	54	12	VL1618DBO	\$647

- one fixed shelf, two adjustable shelves
- one back panel grommet
- backside of unit intended to go against a wall, cabinet should be secured to a wall as a safety precaution

Description	D	W	H	CTN WT	CU FT	① Model	List Price
Double Height Storage Tower with 29" h Doors	16	36	54	117	23	VL1636DSB	\$1,178
	16	30	54	104	19	VL1630DSB	\$1,140

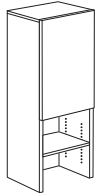
**NOW!**



- 29" door height
- one fixed shelf, two adjustable shelves
- one back panel grommet
- non-locking
- no pulls
- backside of unit intended to go against a wall, cabinet should be secured to a wall as a safety precaution

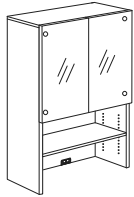
Double Height Storage Tower with 29" h Door	16	18	54	59	12	VL1618DSBR	\$815
	16	18	54	59	12	VL1618DSBL	\$815

**NOW!**



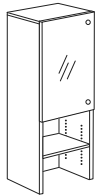
- 29" door height
- one fixed shelf, two adjustable shelves
- one back panel grommet
- non-locking
- no pull
- backside of unit intended to go against a wall, cabinet should be secured to a wall as a safety precaution

							Frameless List Price	Aluminum Frame List Price
Double Height Storage Tower with 29" h Glass Doors	16	36	54	117	23	VL1636DGSB	\$1,517	\$1,872
	16	30	54	104	19	VL1630DGSB	\$1,465	\$1,802



- select Frosted Frameless, Frosted with Aluminum Frame or White Back Painted with Aluminum Frame
- 29" door height
- one fixed shelf, two adjustable shelves
- one back panel grommet
- locking doors not available
- pulls not available
- backside of unit intended to go against a wall, cabinet should be secured to a wall as a safety precaution

Double Height Storage Tower with 29" h Glass Door	16	18	54	59	12	VL1618DGSR	\$1,185	\$1,363
	16	18	54	59	12	VL1618DGSBL	\$1,185	\$1,363



right shown

- select Frosted Frameless, Frosted with Aluminum Frame or White Back Painted with Aluminum Frame
- 29" door height
- one fixed shelf, two adjustable shelves
- one back panel grommet
- locking door not available
- pull not available
- backside of unit intended to go against a wall, cabinet should be secured to a wall as a safety precaution

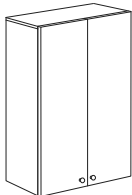
**To Order, Specify:**

- ① Model Number
- ② Laminate Color (see page 38)
  - a.) Chassis Color
  - b.) Door Color
- ③ Glass Option/Color (see page 47)
- ④ Knob Color - Matte Black (MBK) or Matte Nickel (MNK) (see page 43) ▲
- ⑤ Grommet Color - Matte Black (MBK) or Stardust Silver (STS) (see page 44)
- ⑥ Fabric Selection: vendor, pattern, color
- ⑦ Other Product Options (see page 39)

When ordering Quickship products, place a "Q" in front of model number.  
Example: QVL3072DD

**NOW!**  
Need it.  
JSI Quickship

Description	D	W	H	CTN WT	CU FT	① Model	List Price
Double Height Storage Tower with 54" h Doors	16	36	54	129	23	VL1636DSTD	\$1,265
	16	30	54	115	19	VL1630DSTD	\$1,169

**NOW!**


- 54" door height
- one fixed shelf, two adjustable shelves
- one back panel grommet
- locking doors available, specify and add \$105 list
- pull knobs

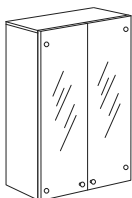
Double Height Storage Tower with 54" h Door	16	18	54	67	12	VL1618DSTDR	\$844
	16	18	54	67	12	VL1618DSTD	\$844

**NOW!**


- 54" door height
- one fixed shelf, two adjustable shelves
- one back panel grommet
- locking door available, specify and add \$105 list
- pull knob

right shown

Description	D	W	H	CTN WT	CU FT	① Model	Frameless	Aluminum
							List Price	Frame List Price
Double Height Storage Tower with 54" h Glass Doors	16	36	54	129	23	VL1636DGSTD	\$1,631	\$2,118
	16	30	54	115	19	VL1630DGSTD	\$1,560	\$2,026



- select Frosted Frameless, Frosted with Aluminum Frame or White Back Painted with Aluminum Frame
- 54" door height
- one fixed shelf, two adjustable shelves
- one back panel grommet
- locking doors not available
- pull knobs

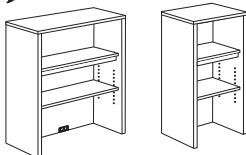
Double Height Storage Tower with 54" h Glass Door	16	18	54	67	12	VL1618DGSTDR	\$1,246	\$1,490
	16	18	54	67	12	VL1618DGSTD	\$1,246	\$1,490



- select Frosted Frameless, Frosted with Aluminum Frame or White Back Painted with Aluminum Frame
- 54" door height
- one fixed shelf, two adjustable shelves
- one back panel grommet
- locking door not available
- pull knob

right shown

Description	D	W	H	CTN WT	CU FT	① Model	List Price
Bookcase Overhead	15 <sup>7</sup> / <sub>16</sub>	36	42	78	13	VL1636B0	\$797
	15 <sup>7</sup> / <sub>16</sub>	30	42	75	13	VL1630B0	\$727
	15 <sup>7</sup> / <sub>16</sub>	18	42	41	9	VL1618B0	\$558

**NOW!**


- fixed shelf on top, adjustable shelf on bottom
- one back panel grommet

Description	D	W	H	CTN WT	CU FT	① Model	List Price
Storage Tower with 17" h Doors	16	36	42	90	13	VL1636SB	\$1,106
	16	30	42	80	13	VL1630SB	\$1,026

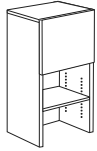
**NOW!**



- 17" door height
- adjustable shelf
- one back panel grommet
- no pulls
- locking doors available, specify and add \$105 list

Storage Tower with 17" h Door	16	18	42	45	9	VL1618SBR	\$728
	16	18	42	45	9	VL1618SBL	\$728

**NOW!**



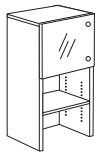
- 17" door height
- adjustable shelf
- one back panel grommet
- no pull
- locking doors available, specify and add \$105 list

							Frameless List Price	Aluminum Frame List Price
Storage Tower with 17" h Glass Doors	16	36	42	90	13	VL1636GSB	\$1,247	\$1,539
	16	30	42	80	13	VL1630GSB	\$1,189	\$1,465



- select Frosted Frameless, Frosted with Aluminum Frame or White Back Painted with Aluminum Frame
- 17" door height
- adjustable shelf
- one back panel grommet
- pulls not available
- locking doors not available

Storage Tower with 17" h Glass Door	16	18	42	45	9	VL1618GSBR	\$912	\$1,059
	16	18	42	45	9	VL1618GSBL	\$912	\$1,059



right shown

- select Frosted Frameless, Frosted with Aluminum Frame or White Back Painted with Aluminum Frame
- 17" door height
- adjustable shelf
- one back panel grommet
- pull not available
- locking door not available

**To Order, Specify:**

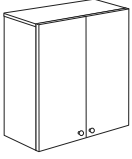
- ① Model Number
- ② Laminate Color (see page 38)
  - a.) Chassis Color
  - b.) Door Color
- ③ Glass Option/Color (see page 47)
- ④ Knob Color - Matte Black (MBK) or Matte Nickel (MNK) (see page 43) ▲
- ⑤ Grommet Color - Matte Black (MBK) or Stardust Silver (STS) (see page 44)
- ⑥ Other Product Options (see page 39)

When ordering Quickship products, place a "Q" in front of model number.  
Example: QVL3072DD

**NOW!**  
Need it.  
JSI Quickship

Description	D	W	H	CTN WT	CU FT	① Model	List Price
Storage Tower with 42" h Doors	16	36	42	99	13	VL1636STD	\$1,173
	16	30	42	88	13	VL1630STD	\$971

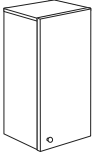
**Now!**



- 42" door height
- adjustable shelf
- one back panel grommet
- locking doors available, specify and add \$105 list
- pull knobs

Storage Tower with 42" h Door	16	18	42	51	9	VL1618STDR	\$765
	16	18	42	51	9	VL1618STDL	\$765

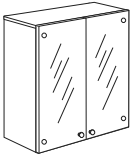
**Now!**



- 42" door height
- adjustable shelf
- one back panel grommet
- locking doors available, specify and add \$105 list
- pull knob

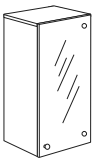
right shown

							Frameless List Price	Aluminum Frame List Price
Storage Tower with 42" h Glass Doors	16	36	42	99	13	VL1636GSTD	\$1,416	\$1,840
	16	30	42	88	13	VL1630GSTD	\$1,200	\$1,599



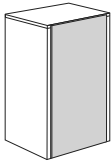
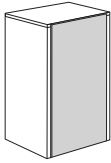
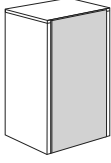
- select Frosted Frameless, Frosted with Aluminum Frame or White Back Painted with Aluminum Frame
- 42" door height
- adjustable shelf
- one back panel grommet
- locking doors not available
- pull knobs

Storage Tower with 42" h Glass Door	16	18	42	51	9	VL1618GSTDR	\$958	\$1,171
	16	18	42	51	9	VL1618GSTDL	\$958	\$1,171



- select Frosted Frameless, Frosted with Aluminum Frame or White Back Painted with Aluminum Frame
- 42" door height
- adjustable shelf
- one back panel grommet
- locking door not available
- pull knob

right shown

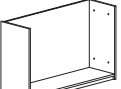
Description	D	W	H	CTN WT	CU FT	① Model	List Price Per Grade
<b>36" w Fabric Back Panel for Storage Tower</b> 	3/8	34	42	8	5	<b>VS3642STB</b>	<b>COM \$258</b> A \$270 B \$294 C \$338 D \$393 E \$448 F \$533 G \$625 H \$723 I \$875 J \$1,059
• for use with 36" wide storage tower • Culp Montgomery Sterling panel fabric standard, use Grade A pricing • other fabrics available, contact Customer Service • attaches with covered button screws • ships attached when ordered with storage towers • com ydg: 1 1/4							
<b>30" w Fabric Back Panel for Storage Tower</b> 	3/8	28	42	7	4	<b>VS3042STB</b>	<b>COM \$230</b> A \$243 B \$267 C \$310 D \$366 E \$420 F \$506 G \$598 H \$696 I \$848 J \$1,032
• for use with 30" wide storage tower • Culp Montgomery Sterling panel fabric standard, use Grade A pricing • other fabrics available, contact Customer Service • attaches with covered button screws • ships attached when ordered with storage towers • com ydg: 1 1/4							
<b>18" w Fabric Back Panel for Storage Tower</b> 	3/8	16	42	4	2	<b>VS1842STB</b>	<b>COM \$180</b> A \$188 B \$202 C \$228 D \$261 E \$294 F \$346 G \$401 H \$459 I \$551 J \$661
• for use with 18" wide storage tower • Culp Montgomery Sterling panel fabric standard, use Grade A pricing • other fabrics available, contact Customer Service • attaches with covered button screws • ships attached when ordered with storage towers • com ydg: 3/4							

**To Order, Specify:**

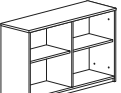
- ① Model Number
- ② Laminate Color (see page 38)
  - a.) Chassis Color
  - b.) Door Color
- ③ Glass Option/Color (see page 47)
- ④ Knob Color - *Matte Black (MBK) or Matte Nickel (MNK) (see page 43) ▲*
- ⑤ Fabric Selection: vendor, pattern, color
- ⑥ Other Product Options (see page 39)

When ordering Quickship products, place a "Q" in front of model number.  
 Example: QVL3072DD

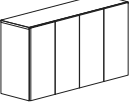


Description	D	W	H	CTN WT	CU FT	Model	List Price
<b>Double Height Bridge Mount Overhead Shelf</b> 	15 7/16	54	30	81	19	VL1554DBTS	\$586
	15 7/16	48	30	72	17	VL1548DBTS	\$512
	15 7/16	42	30	63	15	VL1542DBTS	\$465
	15 7/16	36	30	54	13	VL1536DBTS	\$396
	15 7/16	30	30	51	11	VL1530DBTS	\$394

· must be supported by two storage towers

<b>Double Height Bridge Mount Open Overhead</b> 	15 7/16	54	30	95	19	VL1554DB00	\$800
	15 7/16	48	30	89	17	VL1548DB00	\$727
	15 7/16	42	30	80	15	VL1542DB00	\$662
	15 7/16	36	30	69	13	VL1536DB00	\$603
	15 7/16	30	30	60	11	VL1530DB00	\$546

· must be supported by two storage towers

<b>Double Height Bridge Mount Overhead Cabinet with Four Doors</b> 	16	54	30	205	19	VL1654DBMS	\$1,263
---	----	----	----	-----	----	------------	---------

· must be supported by two storage towers  
 · locking doors available, specify and add \$210 list  
 · no pulls

<b>Double Height Bridge Mount Overhead Cabinet with Three Doors</b> 	16	48	30	195	17	VL1648DBMSR	\$1,082
	16	48	30	195	17	VL1648DBMSL	\$1,082
	16	42	30	181	15	VL1642DBMSR	\$1,028
	16	42	30	181	15	VL1642DBMSL	\$1,028

· must be supported by two storage towers  
 · locking doors available, specify and add \$210 list  
 · right door configuration - 1 door hinges left and 2 doors hinge right  
 · left door configuration - 1 door hinges right and 2 doors hinge left  
 · no pulls

<b>Double Height Bridge Mount Overhead Cabinet with Two Doors</b> 	16	36	30	169	13	VL1636DBMS	\$894
	16	30	30	163	11	VL1630DBMS	\$851

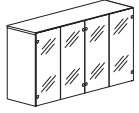
· must be supported by two storage towers  
 · locking doors available, specify and add \$105 list  
 · no pulls

<b>Double Height Bridge Mount Overhead Cabinet with Sliding Door</b> 	16	54	30	208	19	VL1654DBMSSD	\$1,504
	16	48	30	201	17	VL1648DBMSSD	\$1,328
	16	42	30	185	15	VL1642DBMSSD	\$1,272
	16	36	30	173	13	VL1636DBMSSD	\$1,220
	16	30	30	167	11	VL1630DBMSSD	\$1,205

· must be supported by two storage towers  
 · white markerboard doors available, specify and add \$216 list  
 · locking doors not available  
 · pulls not available

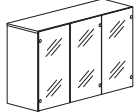
Description	D	W	H	CTN WT	CU FT	① Model	Frameless List Price	Aluminum Frame List Price
-------------	---	---	---	--------	-------	---------	----------------------	---------------------------

Double Height Bridge Mount Overhead Cabinet with Four Glass Doors

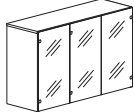


- select Frosted Frameless, Frosted with Aluminum Frame or White Back Painted with Aluminum Frame
- must be supported by two storage towers
- locking doors not available
- pulls not available

Double Height Bridge Mount Overhead Cabinet with Three Glass Doors



right



left

16	48	30	195	17	VL1648DGBMSR	\$1,126	\$1,642
16	48	30	195	17	VL1648DGBMSL	\$1,126	\$1,642
16	42	30	181	15	VL1642DGBMSR	\$1,071	\$1,568
16	42	30	181	15	VL1642DGBMSL	\$1,071	\$1,568

- select Frosted Frameless, Frosted with Aluminum Frame or White Back Painted with Aluminum Frame
- must be supported by two storage towers
- right door configuration - 1 door hinges left and 2 doors hinge right
- left door configuration - 1 door hinges right and 2 doors hinge left
- locking doors not available
- pulls not available

Double Height Bridge Mount Overhead with Glass Doors



16	36	30	169	13	VL1636DGBMS	\$873	\$1,228
16	30	30	163	11	VL1630DGBMS	\$831	\$1,168

- select Frosted Frameless, Frosted with Aluminum Frame or White Back Painted with Aluminum Frame
- must be supported by two storage towers
- locking doors not available
- pulls not available

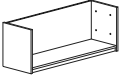
**To Order, Specify:**

- ① Model Number
- ② Laminate Color (see page 38)
  - a.) Chassis Color
  - b.) Door Color
- ③ Glass Option/Color (see page 47)
- ④ Other Product Options (see page 39)

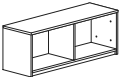
When ordering Quickship products, place a "Q" in front of model number.  
Example: QVL3072DD





Description	D	W	H	CTN WT	CU FT	① Model	List Price
<b>Bridge Mount Overhead Shelf</b> 	15 7/16	54	18	62	12	VL1554BTS	\$533
	15 7/16	48	18	55	11	VL1548BTS	\$466
	15 7/16	42	18	48	10	VL1542BTS	\$423
	15 7/16	36	18	41	8	VL1536BTS	\$361
	15 7/16	30	18	39	7	VL1530BTS	\$359

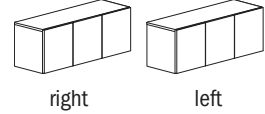
- must be supported by two storage towers

<b>Bridge Mount Open Overhead</b> 	15 7/16	54	18	73	12	VL1554B00	\$727
	15 7/16	48	18	68	11	VL1548B00	\$661
	15 7/16	42	18	61	10	VL1542B00	\$602
	15 7/16	36	18	53	8	VL1536B00	\$549
	15 7/16	30	18	46	7	VL1530B00	\$497


- must be supported by two storage towers

<b>Bridge Mount Overhead Cabinet with Four Doors</b> 	16	54	18	157	12	VL1654BMS	\$921
---	----	----	----	-----	----	-----------	-------

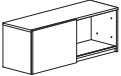
- must be supported by two storage towers
- locking doors available, specify and add \$210 list
- no pulls

<b>Bridge Mount Overhead Cabinet with Three Doors</b> 	16	48	18	150	11	VL1648BMSR	\$845
	16	48	18	150	11	VL1648BMSL	\$845
	16	42	18	139	10	VL1642BMSR	\$800
	16	42	18	139	10	VL1642BMSL	\$800

- must be supported by two storage towers
- locking doors available, specify and add \$210 list
- right door configuration - 1 door hinges left and 2 doors hinge right
- left door configuration - 1 door hinges right and 2 doors hinge left
- no pulls

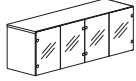
<b>Bridge Mount Overhead Cabinet with Two Doors</b> 	16	36	18	130	8	VL1636BMS	\$693
	16	30	18	125	7	VL1630BMS	\$657

- must be supported by two storage towers
- locking doors available, specify and add \$105 list
- no pulls

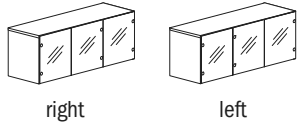
<b>Bridge Mount Overhead Cabinet with Sliding Door</b> 	16	54	18	160	12	VL1654BMSSD	\$1,194
	16	48	18	154	11	VL1648BMSSD	\$1,024
	16	42	18	142	10	VL1642BMSSD	\$977
	16	36	18	133	8	VL1636BMSSD	\$854
	16	30	18	128	7	VL1630BMSSD	\$840

- must be supported by two storage towers
- white markerboard doors available, specify and add \$163 list
- locking door not available
- pulls not available

Description	D	W	H	CTN WT	CU FT	① Model	Frameless List Price	Aluminum Frame List Price
-------------	---	---	---	-----------	----------	---------	-------------------------	---------------------------------

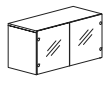
<b>Bridge Mount Overhead Cabinet with Four Glass Doors</b> 	16	54	18	157	12	<b>VL1654GBMS</b>	\$1,185	\$1,720
	<ul style="list-style-type: none"> <li>· select Frosted Frameless, Frosted with Aluminum Frame or White Back Painted with Aluminum Frame</li> <li>· must be supported by two storage towers</li> <li>· locking doors not available</li> <li>· pulls not available</li> </ul>							

<b>Bridge Mount Overhead Cabinet with Three Glass Doors</b>	16	48	18	150	11	<b>VL1648GBMSR</b>	\$1,126	\$1,547
	16	48	18	150	11	<b>VL1648GBMSL</b>	\$1,126	\$1,547



<b>Bridge Mount Overhead Cabinet with Three Glass Doors</b>	16	42	18	139	10	<b>VL1642GBMSR</b>	\$1,071	\$1,474
	16	42	18	139	10	<b>VL1642GBMSL</b>	\$1,071	\$1,474
	<ul style="list-style-type: none"> <li>· select Frosted Frameless, Frosted with Aluminum Frame or White Back Painted with Aluminum Frame</li> <li>· must be supported by two storage towers</li> <li>· right door configuration - 1 door hinges left and 2 doors hinge right</li> <li>· left door configuration - 1 door hinges right and 2 doors hinge left</li> <li>· locking doors not available</li> <li>· pulls not available</li> </ul>							

<b>Bridge Mount Overhead Cabinet with Two Glass Doors</b>	16	36	18	130	8	<b>VL1636GBMS</b>	\$873	\$1,165
	16	30	18	125	7	<b>VL1630GBMS</b>	\$831	\$1,107



<ul style="list-style-type: none"> <li>· select Frosted Frameless, Frosted with Aluminum Frame or White Back Painted with Aluminum Frame</li> <li>· must be supported by two storage towers</li> <li>· locking doors not available</li> <li>· pulls not available</li> </ul>							
--	--	--	--	--	--	--	--

**To Order, Specify:**

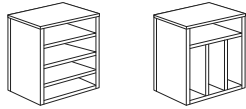
- ① Model Number
- ② Laminate Color (see page 38)
  - a.) Chassis Color
  - b.) Door Color
- ③ Glass Option/Color (see page 47)
- ④ Other Product Options (see page 39)

When ordering Quickship products, place a "Q" in front of model number.  
 Example: QVL3072DD



Description	D	W	H	CTN WT	CU FT	① Model	List Price
Storage Tower Insert Transaction Support Cabinet	10 <sup>3</sup> / <sub>4</sub>	16	24 <sup>3</sup> / <sub>4</sub>	18	6	VL2016ST	\$607

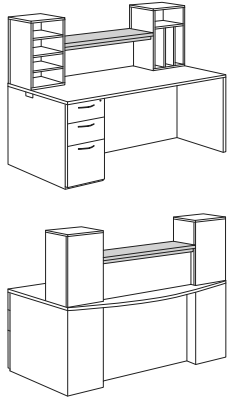
**NOW!**



- support for transaction surfaces
- paper management slots can be configured horizontally or with three vertical slots
- can be used under storage overhead cabinet
- see page 57 for application

Description	D	W	H	CTN WT	CU FT	① Model	TFL List Price	HPL List Price
Transaction Surface Top	14	40	3	21	5	VL1440TS	\$225	\$237
	14	34	3	17	5	VL1434TS	\$210	\$221
	14	28	3	13	5	VL1428TS	\$204	\$215

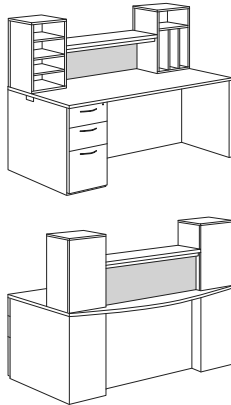
**NOW!**



- top edge profile on user and approach sides
- long grain direction
- must be supported by two VL2016ST; see above
- VL1440TS sets on top of 72" desk or credenza top
- VL1434TS sets on top of 66" desk or credenza top
- VL1428TS sets on top of 60" desk or credenza top
- trim transaction panel available, see below

Description	D	W	H	CTN WT	CU FT	① Model	List Price
Transaction Trim Panel	<sup>1</sup> / <sub>4</sub>	39 <sup>1</sup> / <sub>2</sub>	12	5	2	VS1240FTS	\$465
	<sup>1</sup> / <sub>4</sub>	33 <sup>1</sup> / <sub>2</sub>	12	5	2	VS1234FTS	\$446
	<sup>1</sup> / <sub>4</sub>	27 <sup>1</sup> / <sub>2</sub>	12	4	2	VS1228FTS	\$398

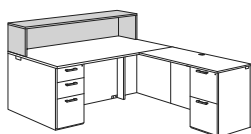
**NOW!**



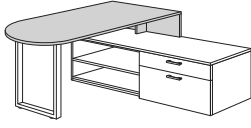

- frosted acrylic panel
- coordinates with two VL2016ST and transaction surface

Description	D	W	H	CTN WT	CU FT	① Model	TFL List Price	HPL List Price
Transaction Counter	13	72	16	87	9	VL1372TC	\$704	\$741
	13	66	16	79	8	VL1366TC	\$671	\$706

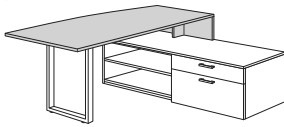
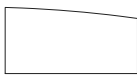
**NOW!**



- VL1372TC coordinates with 72" worksurface
- VL1366TC coordinates with 66" worksurface
- back panel grain is horizontal

Description	D	W	H	CTN WT	CU FT	① Model	TFL List Price	HPL List Price
Bench Height Supported	36	84	9 1/2	170	22	VLB3684B	\$1,418	\$1,493
Bullet Peninsula Desk	36	78	9 1/2	164	21	VLB3678B	\$1,378	\$1,451
<b>NOW!</b>	36	72	9 1/2	158	19	VLB3672B	\$1,159	\$1,220
	30	84	9 1/2	163	19	VLB3084B	\$1,330	\$1,399
	30	78	9 1/2	158	18	VLB3078B	\$1,286	\$1,353
	30	72	9 1/2	153	16	VLB3072B	\$1,122	\$1,181

- must attach to bench height cabinets, see pages 182-191
- edge profile on three open sides
- one end panel grommet
- trim modesty panel, see page 181
- non-handed
- not recommended for freestanding use
- bases must be purchased separately; see page 181 for options

Bench Height Supported	36	84	9 1/2	171	22	VLB3684FINR	\$1,409	\$1,482
Fin Peninsula Desk	36	84	9 1/2	171	22	VLB3684FINL	\$1,409	\$1,482
<b>NOW!</b>	36	78	9 1/2	165	21	VLB3678FINR	\$1,367	\$1,438
	36	78	9 1/2	165	21	VLB3678FINL	\$1,367	\$1,438
left shown	36	72	9 1/2	159	19	VLB3672FINR	\$1,231	\$1,295
	36	72	9 1/2	159	19	VLB3672FINL	\$1,231	\$1,295
left	30	84	9 1/2	164	19	VLB3084FINR	\$1,328	\$1,397
right	30	84	9 1/2	164	19	VLB3084FINL	\$1,328	\$1,397
	30	78	9 1/2	159	18	VLB3078FINR	\$1,277	\$1,344
	30	78	9 1/2	159	18	VLB3078FINL	\$1,277	\$1,344
	30	72	9 1/2	154	16	VLB3072FINR	\$1,151	\$1,211
	30	72	9 1/2	154	16	VLB3072FINL	\$1,151	\$1,211

- 30" deep at end panel for 36" deep top
- 24" deep at end panel for 30" deep top
- must attach to bench height cabinets, see pages 182-191
- edge profile on three open sides
- one end panel grommet
- trim modesty panel, see page 181
- not recommended for freestanding use
- bases must be purchased separately; see page 181 for options

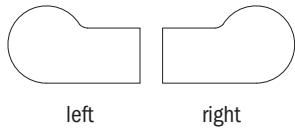
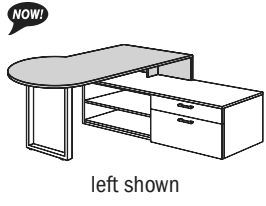
**To Order, Specify:**

- ① Model Number
- ▲ ② Worksurface Material (see page 38)
  - a.) TFL
  - b.) HPL
- ③ Laminate Color (see page 38)
  - a.) Worksurface Color
  - b.) Chassis Color
- ④ Edge Profile (see page 43)
- ⑤ Grommet Color - Matte Black (MBK) or Stardust Silver (STS) (see page 44)
- ⑥ Other Product Options (see page 39)
- ⑦ Accessories (see page 407)
- ⑧ Power and Data Options (see page 407)

When ordering Quickship products, place a "Q" in front of model number.  
Example: QVL3072DD

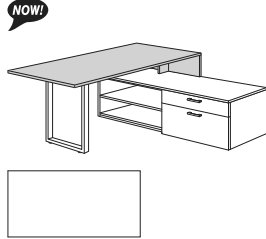
**NOW!**  
Need it.  
JSI Quickship

Description	D	W	H	CTN WT	CU FT	① Model	TFL List Price	HPL List Price
Bench Height Supported P-Top Peninsula Desk	42	84	9 1/2	185	26	VLB4284RP	\$1,507	\$1,586
	42	84	9 1/2	185	26	VLB4284LP	\$1,507	\$1,586
	42	78	9 1/2	179	24	VLB4278RP	\$1,453	\$1,528
	42	78	9 1/2	179	24	VLB4278LP	\$1,453	\$1,528
	42	72	9 1/2	170	22	VLB4272RP	\$1,363	\$1,435
	42	72	9 1/2	170	22	VLB4272LP	\$1,363	\$1,435



- 42" widest point
- 30" at end panel
- must attach to bench height cabinets, see pages 182-191
- edge profile on three open sides
- one end panel grommet
- trim modesty panel, see page 181
- not recommended for freestanding use
- bases must be purchased separately; see page 181 for options

Bench Height Supported Rectangle Peninsula Desk	36	84	9 1/2	171	22	VLB3684RCT	\$1,054	\$1,108
	36	78	9 1/2	165	21	VLB3678RCT	\$995	\$1,046
	36	72	9 1/2	159	19	VLB3672RCT	\$950	\$1,003
	30	84	9 1/2	164	19	VLB3084RCT	\$1,004	\$1,057
	30	78	9 1/2	159	18	VLB3078RCT	\$968	\$1,018
	30	72	9 1/2	154	16	VLB3072RCT	\$938	\$987



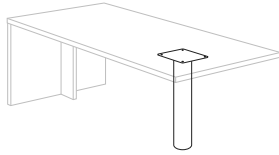
- must attach to bench height cabinets, see pages 182-191
- edge profile on three open sides
- one end panel grommet
- trim modesty panel, see page 181
- non-handed
- not recommended for freestanding use
- bases must be purchased separately; see page 181 for options

VISION - LAMINATE

Description

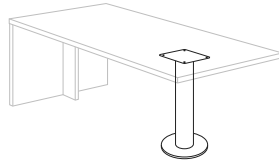
Base Options for Bench Height Supported Peninsula Desks (these bases must be ordered separately from the desks listed on pages 179-180)

**NOW!**



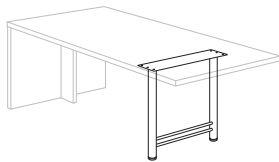
- Column Base**
- 04BB - Black Sandtex- \$321
  - 04SB - Stardust Silver - \$321

- Base:**
- 13 gauge steel
  - 4" diameter



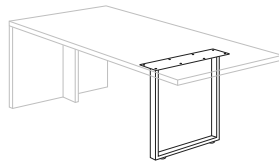
- Column Disk Base**
- 12DB - Black Sandtex- \$385
  - 12DS - Stardust Silver - \$385

- Base:**
- support disk: 11" diameter



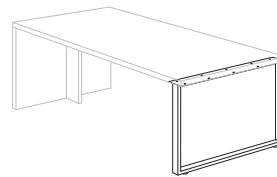
- H Base**
- use with 36" or 48" deep tops
- 24HB - Black Sandtex - \$354
  - 24HS - Stardust Silver - \$354

- use with 30" deep tops
- 18HB - Black Sandtex - \$333
  - 18HS - Stardust Silver - \$333



- U Base**
- use with 36" or 48" deep tops
- 24UB - Black Sandtex- \$354
  - 24US - Stardust Silver - \$354

- use with 30" deep tops
- 18UB - Black Sandtex- \$333
  - 18US - Stardust Silver - \$333



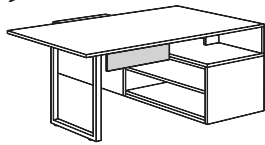
- ▲ Rectangular Base**
- use with 36" deep tops
- 36FSQB - Black Sandtex- \$473
  - 36FSQS - Stardust Silver - \$473

- use with 30" deep tops
- 30FSQB - Black Sandtex- \$457
  - 30FSQS - Stardust Silver - \$457

\*\* should not be used with fin shaped tops

Description	D	W	H	CTN WT	CU FT	① Model	List Price
Trim Modesty Panel for Bench Height Supported Peninsula Desks	1/4	40	10	5	2	VS1040FMP	\$458
	1/4	34	10	4	2	VS1034FMP	\$438
	1/4	28	10	4	1	VS1028FMP	\$388

**NOW!**



- mounts in open kneespace area
- acrylic panel - frosted
- field installed
- VS1040FMP use with 84" bullet, fin, P-top or rectangle peninsula desk for bench height
- VS1034FMP use with 78" bullet, fin, P-top or rectangle peninsula desk for bench height
- VS1028FMP use with 72" bullet, fin, P-top or rectangle peninsula desk for bench height

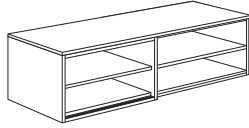
To Order, Specify:

- ① Model Number
- ▲ ② Worksurface Material (see page 38)
  - a.) TFL
  - b.) HPL
- ③ Laminate Color (see page 38)
- ④ Edge Profile (see page 43)
- ⑤ Grommet Color - Matte Black (MBK) or Stardust Silver (STS) (see page 44)
- ⑥ Other Product Options (see page 39)
- ⑦ Power and Data Options (see page 407)

When ordering Quickship products, place a "Q" in front of model number.  
Example: QVL3072DD

**NOW!**  
Need it.  
JSI Quickship

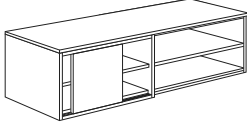
Freestanding Bench Height Configurations

Description	D	W	H	CTN WT	CU FT	① Model	List Price
72" w and 60" w Bench Height Configurations 	24	72	19 1/2	284	24	<b>VLB-36BF36BF**</b> 36" Box/File - left 36" Box/File - right	\$1,520
	24	60	19 1/2	270	21	<b>VLB-30BF30BF**</b> 30" Box/File - left 30" Box/File - right	\$1,411
	24	72	19 1/2	245	24	<b>VLB-36BF36OS</b> 36" Box/File - left 36" Open Shelf - right	\$1,320
	24	60	19 1/2	230	21	<b>VLB-30BF30OS</b> 30" Box/File - left 30" Open Shelf - right	\$1,221
	24	72	19 1/2	226	24	<b>VLB-36HD36OS</b> 36" Hinged Doors - left 36" Open Shelf - right	\$1,247
	24	60	19 1/2	213	21	<b>VLB-30HD30OS</b> 30" Hinged Doors - left 30" Open Shelf - right	\$1,150
	24	72	19 1/2	274	24	<b>VLB-36OF36OF**</b> 36" Open/File - left 36" Open/File - right	\$1,512
	24	60	19 1/2	244	21	<b>VLB-30OF30OF**</b> 30" Open/File - left 30" Open/File - right	\$1,397
	24	72	19 1/2	245	24	<b>VLB-36OS36BF</b> 36" Open Shelf - left 36" Box/File - right	\$1,320
	24	60	19 1/2	230	21	<b>VLB-30OS30BF</b> 30" Open Shelf - left 30" Box/File - right	\$1,221
	24	72	19 1/2	226	24	<b>VLB-36OS36HD</b> 36" Open Shelf - left 36" Hinged Doors - right	\$1,247
	24	60	19 1/2	213	21	<b>VLB-30OS30HD</b> 30" Open Shelf - left 30" Hinged Doors - right	\$1,150
	24	72	19 1/2	206	24	<b>VLB-36OS36OS</b> 36" Open Shelf - left 36" Open Shelf - right	\$1,122
	24	60	19 1/2	190	21	<b>VLB-30OS30OS</b> 30" Open Shelf - left 30" Open Shelf - right	\$1,032

- 3/4" common top panel
- two 20 lb. counterweights required, see page 193 for counterweight\*\*
- unit can be secured to wall or floor as alternative to counterweight\*\*
- locking drawer available, specify and add \$105 list per drawer set
- locking hinged doors available, specify and add \$105 list per door set

VISION - LAMINATE

Freestanding Bench Height Configurations

Description	D	W	H	CTN WT	CU FT	① Model	List Price
72" w and 60" w Bench Height Configurations 	24	72	19 1/2	227	24	<b>VLB-360S36SD</b> 36" Open Shelf - left 36" Sliding Door - right	\$1,373
	24	60	19 1/2	208	21	<b>VLB-300S30SD</b> 30" Open Shelf - left 30" Sliding Door - right	\$1,279
	24	72	19 1/2	227	24	<b>VLB-36SD360S</b> 36" Sliding Door - left 36" Open Shelf - right	\$1,373
	24	60	19 1/2	208	21	<b>VLB-30SD300S</b> 30" Sliding Door - left 30" Open Shelf - right	\$1,279
	24	72	19 1/2	248	24	<b>VLB-36SD36SD</b> 36" Sliding Door - left 36" Sliding Door - right	\$1,625
	24	60	19 1/2	226	21	<b>VLB-30SD30SD</b> 30" Sliding Door - left 30" Sliding Door - right	\$1,527

**NOW!**

- 3/4" common top panel
- locking sliding doors not available

VISION - LAMINATE

To Order, Specify:

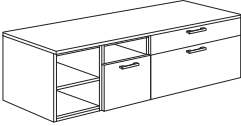
- ① Model Number
- ② Laminate Color (see page 38)
  - a.) Chassis Color
  - b.) Drawer/Door Color
- ③ Pull Style and Color (see page 43)
- ④ Other Product Options (see page 39)

When ordering Quickship products, place a "Q" in front of model number.  
Example: QVL3072DD





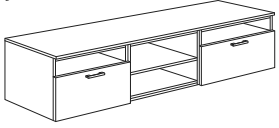
**Freestanding Bench Height Configurations**

Description	D	W	H	CTN WT	CU FT	① Model	List Price
<b>72" Bench Height Configurations</b> 	24	72	19 1/2	274	24	<b>VLB-360S18BF18HR</b> 36" Open Shelf - left 18" Box/File - center 18" Hinged Door - right	\$1,651
	24	72	19 1/2	274	24	<b>VLB-18HL18BF360S</b> 18" Hinged Door - left 18" Box/File - center 36" Open Shelf - right	\$1,651
	24	72	19 1/2	304	24	<b>VLB-36BF18BF180S**</b> 36" Box/File - left 18" Box/File - center 18" Open Shelf - right	\$1,742
	24	72	19 1/2	304	24	<b>VLB-180S18BF36BF**</b> 18" Open Shelf - left 18" Box/File - center 36" Box/File - right	\$1,742
	24	72	19 1/2	297	24	<b>VLB-36BF180F180S**</b> 36" Box/File - left 18" Open/File - center 18" Open Shelf - right	\$1,727
	24	72	19 1/2	297	24	<b>VLB-180S180F36BF**</b> 18" Open Shelf - left 18" Open/File - center 36" Box/File - right	\$1,727

- 3/4" common top panel
- one 20 lb. counterweight required, see page 193 for counterweight\*\*
- unit can be secured to wall or floor as alternative to counterweight\*\*
- locking drawers available, specify and add \$105 list per drawer set
- locking hinged doors available, specify and add \$105 list per door set

VISION - LAMINATE

Freestanding Bench Height Configurations

Description	D	W	H	CTN WT	CU FT	① Model	List Price
<b>90" Bench Height Configurations</b> 	24	90	19 1/2	285	30	<b>VLB-300S300S300S</b> (3) 30" Open Shelf	\$1,530
	24	90	19 1/2	366	30	<b>VLB-300F300F300F**</b> (3) 30" Open/File	\$2,077
	24	90	19 1/2	365	30	<b>VLB-30BF300S30BF</b> 30" Box/File - left 30" Open Shelf - center 30" Box/File - right	\$1,908
	24	90	19 1/2	339	30	<b>VLB-300F300S300F</b> 30" Open File - left 30" Open Shelf - center 30" Open/File - right	\$1,895
	24	90	19 1/2	343	30	<b>VLB-300S30HD30BF</b> 30" Open Shelf - left 30" Hinged Doors - center 30" Box/File - right	\$1,838
	24	90	19 1/2	343	30	<b>VLB-30BF30HD300S</b> 30" Box/File - left 30" Hinged Doors - center 30" Open Shelf - right	\$1,838
	24	90	19 1/2	351	30	<b>VLB-30BF30SD300S</b> 30" Box/File - left 30" Sliding Door - center 30" Open Shelf - right	\$1,966
	24	90	19 1/2	351	30	<b>VLB-300S30SD30BF</b> 30" Open Shelf - left 30" Sliding Door - center 30" Box/File - right	\$1,966

- 3/4" common top panel
- three 20 lb. counterweights required, see page 193 for counterweight\*\*
- unit can be secured to wall or floor as alternative to counterweight\*\*
- locking sliding doors not available
- locking drawer(s) available, specify and add \$105 list per drawer set
- locking hinged doors available, specify and add \$105 list per door set

To Order, Specify:

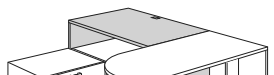
- ① Model Number
- ② Laminate Color (see page 38)
  - a.) Chassis Color
  - b.) Drawer/Door Color
- ③ Pull Style and Color (see page 43)
- ④ Other Product Options (see page 39)

When ordering Quickship products, place a "Q" in front of model number.  
 Example: QVL3072DD



VISION - LAMINATE

**Freestanding Bench Height**

Description	D	W	H	CTN WT	CU FT	① Model	TFL List Price	HPL List Price
Bench Height Supported Shell Return	24	72	30	149	36	VLB2472RSHR	\$832	\$875
	24	72	30	149	36	VLB2472LSHR	\$832	\$875
 left shown	24	66	30	143	33	VLB2466RSHR	\$774	\$814
	24	66	30	143	33	VLB2466LSHR	\$774	\$814

- must be attached to bench height cabinets, see pages 182-191
- top edge profile on user side
- long grain direction for 66" and 72" wide laminate worksurface
- one end and back panel grommet
- one surface grommet

Bench Height Supported Cockpit Shell Return	24	66	30	153	36	VLB2466RCSHR	\$978	\$1,028
	24	66	30	153	36	VLB2466LCSHR	\$978	\$1,028
 left shown	24	60	30	147	33	VLB2460RCSHR	\$919	\$968
	24	60	30	147	33	VLB2460LCSHR	\$919	\$968
	24	54	30	147	33	VLB2454RCSHR	\$887	\$933
	24	54	30	147	33	VLB2454LCSHR	\$887	\$933

- must be attached to bench height cabinets, see pages 182-191
- top edge profile on user side
- long grain direction for 66" wide laminate worksurface
- short grain direction for 54" and 60" wide laminate worksurface
- one end and back panel grommet
- one surface grommet

Bench Height Supported Shell Credenza	24	72	30	157	36	VLB2472SHBR	\$951	\$1,000
	24	72	30	157	36	VLB2472SHBL	\$951	\$1,000
 right shown	24	66	30	151	33	VLB2466SHBR	\$896	\$942
	24	66	30	151	33	VLB2466SHBL	\$896	\$942

- must be attached to bench height cabinets, see pages 182-191
- long grain direction for 66" and 72" wide laminate worksurface
- edge profile on user side only
- one end and back panel grommet

Shell Credenza	24	72	30	159	36	VL2472SHD	\$951	\$1,000
	24	66	30	153	33	VL2466SHD	\$896	\$942

- for use with bench height cabinets, see pages 182-191
- long grain direction
- edge profile on user side only
- two end panel grommets and one back panel grommet

VISION - LAMINATE

### Freestanding Bench Height Cabinets

Description	D	W	H	CTN WT	CU FT	① Model	List Price
Box/File Bench Height Pedestal	24	36	19 1/2	142	13	VLB2436BF	\$777
Box/File Bench Height Pedestal	18	36	19 1/2	126	10	VLB1836BF	\$723
	24	30	19 1/2	135	11	VLB2430BF	\$724
	18	30	19 1/2	121	8	VLB1830BF	\$668



- freestanding unit with top
- specify chassis color
- specify top drawer color
- specify bottom drawer color
- one 20 lb. counterweight required for 24" deep units, two 20 lb. counterweights required for 18" deep units, see page 193 for counterweight
- unit can be secured to wall or floor as alternative to counterweight
- locking drawers available, specify and add \$105 list

Box/File Bench Height Pedestal	24	18	19 1/2	89	7	VLB2418BF	\$594
Box/File Bench Height Pedestal	18	18	19 1/2	79	5	VLB1818BF	\$560



- freestanding unit with top
- specify chassis color
- specify top drawer color
- specify bottom drawer color
- one 10 lb. counterweight required for 24" deep unit, one 20 lb. counterweight required for 18" deep unit, see page 193 for counterweight
- unit can be secured to wall or floor as alternative to counterweight
- locking drawers available, specify and add \$105 list


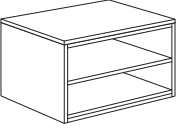

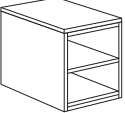

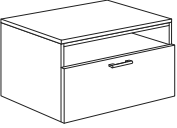

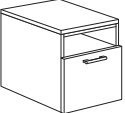

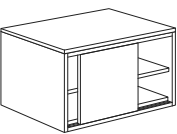
#### To Order, Specify:

- |   |   |
|---|---|
| <ul style="list-style-type: none"> <li>① Model Number</li> <li>▲ ② Worksurface Material (see page 38)                             <ul style="list-style-type: none"> <li>a.) TFL</li> <li>b.) HPL</li> </ul> </li> <li>③ Laminate Color (see page 38)                             <ul style="list-style-type: none"> <li>a.) Chassis Color</li> <li>b.) Drawer/Door Color                                     <ul style="list-style-type: none"> <li>1.) Top Drawer Color</li> <li>2.) Bottom Drawer Color</li> </ul> </li> </ul> </li> </ul> | <ul style="list-style-type: none"> <li>④ Edge Profile (see page 43)</li> <li>⑤ Grommet Color - Matte Black (MBK) or Stardust Silver (STS) (see page 44)</li> <li>⑥ Pull Style and Color (see page 43)</li> <li>⑦ Other Product Options (see page 39)</li> </ul> |
|---|---|

When ordering Quickship products, place a "Q" in front of model number.  
Example: QVL3072DD

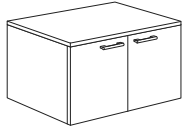


## Freestanding Bench Height Cabinets

Description	D	W	H	CTN WT	CU FT	① Model	List Price
Open Shelf Bench Height Pedestal	24	36	19 1/2	103	13	VLB24360S	\$579
	18	36	19 1/2	87	10	VLB18360S	\$514
 	24	30	19 1/2	95	11	VLB24300S	\$534
	18	30	19 1/2	81	8	VLB18300S	\$478
						<ul style="list-style-type: none"> <li>· freestanding unit with top</li> <li>· adjustable shelf</li> </ul>	
Open Shelf Bench Height Pedestal	24	18	19 1/2	73	7	VLB24180S	\$445
	18	18	19 1/2	63	5	VLB18180S	\$406
 	24	18	19 1/2	73	7	VLB24180S	\$445
	18	18	19 1/2	63	5	VLB18180S	\$406
						<ul style="list-style-type: none"> <li>· freestanding unit with top</li> <li>· adjustable shelf</li> </ul>	
Open Shelf/File Drawer Bench Height Pedestal	24	36	19 1/2	137	13	VLB24360F	\$774
	18	36	19 1/2	121	10	VLB18360F	\$709
 	24	30	19 1/2	122	11	VLB24300F	\$717
	18	30	19 1/2	108	8	VLB18300F	\$655
						<ul style="list-style-type: none"> <li>· freestanding unit with top</li> <li>· one 20 lb. counterweight required for 24" deep unit,</li> <li>two 20 lb. counterweights required for 18" deep unit, see page 193 for counterweights</li> <li>· unit can be secured to wall or floor as alternative to counterweight</li> <li>· locking drawer available, specify and add \$105 list</li> </ul>	
Open Shelf/File Drawer Bench Height Pedestal	24	18	19 1/2	82	7	VLB24180F	\$579
	18	18	19 1/2	72	5	VLB18180F	\$537
 	24	18	19 1/2	82	7	VLB24180F	\$579
	18	18	19 1/2	72	5	VLB18180F	\$537
						<ul style="list-style-type: none"> <li>· freestanding unit with top</li> <li>· one 10 lb. counterweight required for 24" deep unit,</li> <li>one 20 lb. counterweight required for 18" deep unit, see page 193 for counterweights ▲</li> <li>· unit can be secured to wall or floor as alternative to counterweight</li> <li>· locking drawer available, specify and add \$105 list</li> </ul>	
Sliding Door Bench Height Pedestal	24	36	19 1/2	137	13	VLB2436SD	\$831
	18	36	19 1/2	121	10	VLB1836SD	\$762
 	24	30	19 1/2	122	11	VLB2430SD	\$781
	18	30	19 1/2	108	8	VLB1830SD	\$721
						<ul style="list-style-type: none"> <li>· freestanding unit with top</li> <li>· adjustable shelf</li> <li>· locking door not available</li> </ul>	

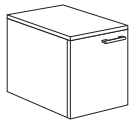
**Freestanding Bench Height Cabinets**

Description	D	W	H	CTN WT	CU FT	① Model	List Price
Hinged Doors Bench Height Pedestal	24	36	19 1/2	123	13	VLB2436HD	\$704
	18	36	19 1/2	107	10	VLB1836HD	\$658
	24	30	19 1/2	118	11	VLB2430HD	\$654
	18	30	19 1/2	104	8	VLB1830HD	\$604

**NOW!**


- freestanding unit with top
- locking doors available, specify and add \$105 list

Hinged Door Bench Height Pedestal	24	18	19 1/2	82	7	VLB2418HR	\$553
	24	18	19 1/2	82	7	VLB2418HL	\$553
	18	18	19 1/2	72	5	VLB1818HR	\$513
	18	18	19 1/2	72	5	VLB1818HL	\$513

**NOW!**


left shown

- freestanding unit with top
- locking door available, specify and add \$105 list

**To Order, Specify:**

- ① Model Number
- ② Laminate Color (see page 38)
  - a.) Chassis Color
  - b.) Drawer/Door Color
- ③ Pull Style and Color (see page 43)
- ④ Other Product Options (see page 39)

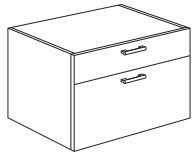
When ordering Quickship products, place a "Q" in front of model number.  
Example: QVL3072DD

**NOW!**  
*Need it.*  
JSI Quickship

## Modular Bench Height Cabinets

These units require a top. Units are meant to sit side by side with a common top. See page 192 for bench height tops.

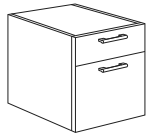
Description	D	W	H	CTN WT	CU FT	Model	List Price
Box/File Bench Height Modular Pedestal	24	36	18 3/4	125	12	VLB2436MBF	\$683
	24	30	18 3/4	121	10	VLB2430MBF	\$639
	18	36	18 3/4	112	10	VLB1836MBF	\$642
	18	30	18 3/4	109	8	VLB1830MBF	\$597



**NOW!**

- use with other modular bench height cabinets and tops
- specify chassis color
- specify top drawer color
- specify bottom drawer color
- if more than two thirds of the area under the common top is occupied by cabinets with a file drawer a 20 lb. counterweight will be required for 24" deep units while two 20 lb. counterweights will be required for 18" deep units, see page 193 for counterweight
- unit can be secured to wall or floor as alternative to counterweight
- locking drawers available, specify and add \$105 list

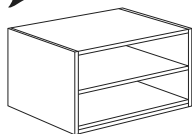
Box/File Bench Height Modular Pedestal	24	18	18 3/4	81	7	VLB2418MBF	\$529
	18	18	18 3/4	72	5	VLB1818MBF	\$501



**NOW!**

- use with other modular bench height cabinets and tops
- specify chassis color
- specify top drawer color
- specify bottom drawer color
- if more than two thirds of the area under the common top is occupied by cabinets with a file drawer a 10 lb. counterweight will be required for 24" deep units while one 20 lb. counterweight will be required for 18" deep units, see page 193 for counterweight ▲
- unit can be secured to wall or floor as alternative to counterweight
- locking drawers available, specify and add \$105 list

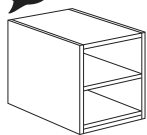
Open Shelf Bench Height Modular Pedestal	24	36	18 3/4	86	12	VLB2436MOS	\$483
	24	30	18 3/4	81	10	VLB2430MOS	\$450
	18	36	18 3/4	73	10	VLB1836MOS	\$433
	18	30	18 3/4	69	8	VLB1830MOS	\$406



**NOW!**

- use with other modular bench height cabinets and tops
- adjustable shelf

Open Shelf Bench Height Modular Pedestal	24	18	18 3/4	65	7	VLB2418MOS	\$380
	18	18	18 3/4	56	5	VLB1818MOS	\$348



**NOW!**

- use with other modular bench height cabinets and tops
- adjustable shelf

Open Shelf/File Drawer Bench Height Modular Pedestal	24	36	18 3/4	120	12	VLB2436MOF	\$680
	24	30	18 3/4	108	10	VLB2430MOF	\$632
	18	36	18 3/4	107	10	VLB1836MOF	\$628
	18	30	18 3/4	96	8	VLB1830MOF	\$582



**NOW!**

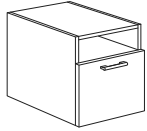
- use with other modular bench height cabinets and tops
- if more than two thirds of the area under the common top is occupied by cabinets with a file drawer a 20 lb. counterweight will be required for 24" deep units while two 20 lb. counterweights will be required for 18" deep units, see page 193 for counterweight ▲
- unit can be secured to wall or floor as alternative to counterweight
- locking drawer available, specify and add \$105 list

**Modular Bench Height Cabinets**

These units require a top. Units are meant to sit side by side with a common top. See page 192 for bench height tops.

Description	D	W	H	CTN WT	CU FT	① Model	List Price
Open Shelf/File Drawer Bench Height Modular Pedestal	24	18	18 3/4	74	7	VLB2418MOF	\$513
	18	18	18 3/4	65	5	VLB1818MOF	\$479

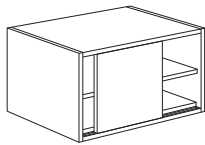
**NOW!**



- use with other modular bench height cabinets and tops
- if more than two thirds of the area under the common top is occupied by cabinets with a file drawer a 10 lb. counterweight will be required for 24" deep units while one 20 lb. counterweight will be required for 18" deep units, see page 193 for counterweight
- unit can be secured to wall or floor as alternative to counterweight
- locking drawer available, specify and add \$105 list

Sliding Door Bench Height Modular Pedestal	24	36	18 3/4	107	12	VLB2436MSD	\$735
	24	30	18 3/4	99	10	VLB2430MSD	\$697
	18	36	18 3/4	94	10	VLB1836MSD	\$681
	18	30	18 3/4	87	8	VLB1830MSD	\$648

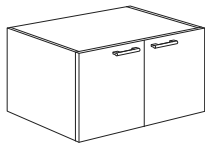
**NOW!**



- use with other modular bench height cabinets and tops
- adjustable shelf
- locking door not available

Hinged Door Bench Height Modular Pedestal	24	36	18 3/4	106	12	VLB2436MHD	\$609
	24	30	18 3/4	104	10	VLB2430MHD	\$569
	18	36	18 3/4	93	10	VLB1836MHD	\$577
	18	30	18 3/4	92	8	VLB1830MHD	\$532

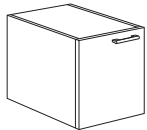
**NOW!**



- use with other modular bench height cabinets and tops
- locking doors available, specify and add \$105 list
- hinge determines left or right for 18" wide units

Hinged Door Bench Height Modular Pedestal	24	18	18 3/4	74	7	VLB2418MHR	\$488
	24	18	18 3/4	74	7	VLB2418MHL	\$488
	18	18	18 3/4	65	5	VLB1818MHR	\$455
	18	18	18 3/4	65	5	VLB1818MHL	\$455

**NOW!**



left shown

- use with other modular bench height cabinets and tops
- locking door available, specify and add \$105 list
- hinge determines left or right for 18" wide units

**To Order, Specify:**


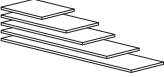
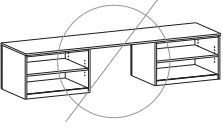
- ① Model Number
- ② Laminate Color (see page 38)
  - a.) Chassis Color
  - b.) Drawer/Door Color
    - 1.) Top Drawer Color
    - 2.) Bottom Drawer Color
- ③ Pull Style and Color (see page 43)
- ④ Other Product Options (see page 39)

When ordering Quickship products, place a "Q" in front of model number.  
Example: QVL3072DD

**NOW!**  
Need it.  
JSI Quickship



**Modular**

Description	D	W	H	CTN WT	CU FT	① Model	List Price
Bench Height Modular Tops	24	108	3/4	63	5	VLB24108MT	\$306
 	24	102	3/4	58	5	VLB24102MT	\$296
	24	96	3/4	55	4	VLB2496MT	\$283
	24	90	3/4	53	4	VLB2490MT	\$273
	24	84	3/4	47	4	VLB2484MT	\$263
	24	78	3/4	44	4	VLB2478MT	\$250
	24	72	3/4	42	4	VLB2472MT	\$241
	24	66	3/4	39	3	VLB2466MT	\$230
	24	60	3/4	35	3	VLB2460MT	\$217
	24	54	3/4	31	3	VLB2454MT	\$207
	24	48	3/4	28	3	VLB2448MT	\$197
	24	36	3/4	21	2	VLB2436MT	\$174
	24	30	3/4	17	2	VLB2430MT	\$160
	24	18	3/4	10	1	VLB2418MT	\$139
	18	108	3/4	54	4	VLB18108MT	\$260
	18	102	3/4	50	4	VLB18102MT	\$251
	18	96	3/4	49	4	VLB1896MT	\$243
	18	90	3/4	46	3	VLB1890MT	\$235
	18	84	3/4	41	4	VLB1884MT	\$226
	18	78	3/4	39	3	VLB1878MT	\$217
	18	72	3/4	36	3	VLB1872MT	\$209
	18	66	3/4	33	3	VLB1866MT	\$200
	18	60	3/4	30	2	VLB1860MT	\$193
	18	54	3/4	27	2	VLB1854MT	\$195
	18	48	3/4	24	2	VLB1848MT	\$174
	18	36	3/4	18	2	VLB1836MT	\$157
	18	30	3/4	15	2	VLB1830MT	\$147
	18	18	3/4	9	1	VLB1818MT	\$129

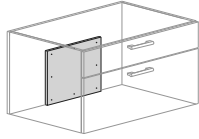
- flat edge on all four sides
- long grain direction
- modular bench height tops NOT intended for unsupported space

VISION - LAMINATE

Modular

Description	D	W	H	CTN WT	CU FT	① Model	List Price
Counterweights for Bench Height Units	3/4	12	11 1/4	21	1	VS20LB	\$184
	3/4	12	6	11	1	VS10LB	\$93

**NOW!**











- counterweight for modular bench height cabinets
- attaches to inside back panel of cabinet
- field installed
- hardware included

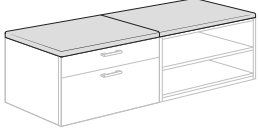
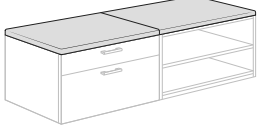
**To Order, Specify:**

- ① Model Number
- ② Laminate Color (see page 38)

When ordering Quickship products, place a "Q" in front of model number.  
Example: QVL3072DD



Description	D	W	H	CTN WT	CU FT	① Model	List Price Per Grade
<b>24" d Bench Height Seat Cushions</b>   <ul style="list-style-type: none"> <li>· 1 1/2" thick</li> <li>· com ydg: 1 1/4</li> </ul>	24	36	1 1/2	14	3	VS2436CUSH	COM \$238
							A \$250
							B \$275
							COL/C \$318
							D \$373
							E \$428
							F \$513
							G \$605
							H \$703
							I \$855
							J \$1,039
							L1 \$672
							L2 \$782
<b>24" d Bench Height Seat Cushions</b>   <ul style="list-style-type: none"> <li>· 1 1/2" thick</li> <li>· com ydg: 1 1/4</li> </ul>	24	30	1 1/2	12	2	VS2430CUSH	COM \$227
							A \$240
							B \$264
							COL/C \$307
							D \$363
							E \$417
							F \$502
							G \$595
							H \$692
							I \$845
							J \$1,028
							L1 \$662
							L2 \$771
<b>24" d Bench Height Seat Cushions</b>   <ul style="list-style-type: none"> <li>· 1 1/2" thick</li> <li>· com ydg: 3/4</li> </ul>	24	18	1 1/2	7	2	VS2418CUSH	COM \$201
							A \$209
							B \$223
							COL/C \$249
							D \$282
							E \$315
							F \$367
							G \$422
							H \$480
							I \$572
							J \$682
							L1 \$461
							L2 \$528
<b>18" d Bench Height Seat Cushions</b>   <ul style="list-style-type: none"> <li>· 1 1/2" thick</li> <li>· com ydg: 1 1/4</li> </ul>	18	36	1 1/2	13	2	VS1836CUSH	COM \$222
							A \$235
							B \$259
							COL/C \$302
							D \$357
							E \$412
							F \$497
							G \$590
							H \$687
							I \$839
							J \$1,023
							L1 \$657
							L2 \$766

Description	D	W	H	CTN WT	CU FT	① Model	List Price Per Grade	
<b>18" d Bench Height Seat Cushions</b>  <p><b>NOW!</b></p> <ul style="list-style-type: none"> <li>• 1 1/2" thick</li> <li>• com ydg: 1 1/4</li> </ul>	18	30	1 1/2	11	2	<b>VS1830CUSH</b>	<b>COM</b> \$212 <b>A</b> \$224 <b>B</b> \$248 <b>COL/C</b> \$291 <b>D</b> \$347 <b>E</b> \$402 <b>F</b> \$487 <b>G</b> \$579 <b>H</b> \$677 <b>I</b> \$829 <b>J</b> \$1,013 <b>L1</b> \$646 <b>L2</b> \$755	
	<b>18" d Bench Height Seat Cushions</b>  <p><b>NOW!</b></p> <ul style="list-style-type: none"> <li>• 1 1/2" thick</li> <li>• com ydg: 3/4</li> </ul>	18	18	1 1/2	6	1	<b>VS1818CUSH</b>	<b>COM</b> \$193 <b>A</b> \$201 <b>B</b> \$215 <b>COL/C</b> \$241 <b>D</b> \$273 <b>E</b> \$307 <b>F</b> \$359 <b>G</b> \$413 <b>H</b> \$472 <b>I</b> \$563 <b>J</b> \$674 <b>L1</b> \$453 <b>L2</b> \$519

VISION - LAMINATE

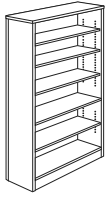
**To Order, Specify:**

- ① Model Number
- ② Fabric Selection: vendor, pattern, color

When ordering Quickship products, place a "Q" in front of model number.  
 Example: QVL3072DD

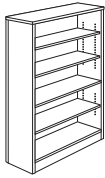
**NOW!**  
*Need it.*  
 JSI Quickship

Description	D	W	H	CTN WT	CU FT	① Model	List Price
Bookcase	16	36	84	181	35	VL3684BC	\$1,115
<b>NOW!</b>	16	30	84	170	29	VL3084BC	\$1,038



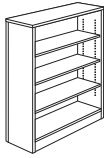
- four adjustable shelves
- one fixed shelf
- no profile edge

Bookcase	16	36	72	155	30	VL3672BC	\$999
<b>NOW!</b>	16	30	72	145	25	VL3072BC	\$887



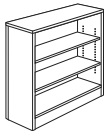
- three adjustable shelves
- one fixed shelf
- no profile edge

Bookcase	16	36	55 1/8	115	23	VL3654BC	\$929
<b>NOW!</b>	16	30	55 1/8	108	20	VL3054BC	\$785



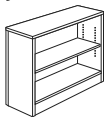
- three adjustable shelves
- no profile edge

Bookcase	16	36	42	108	18	VL3642BC	\$856
<b>NOW!</b>	16	30	42	98	15	VL3042BC	\$686



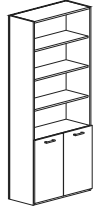
- two adjustable shelves
- no profile edge

Bookcase	16	36	30	108	13	VL3630BC	\$668
<b>NOW!</b>	16	30	30	98	11	VL3030BC	\$618



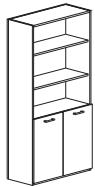
- one adjustable shelf
- no profile edge

Description	D	W	H	CTN WT	CU FT	① Model	List Price
Bookcase with Bottom Doors	16	36	84	196	35	VL3684BCD	\$1,341
<b>NOW!</b>	16	30	84	182	29	VL3084BCD	\$1,255



- four adjustable shelves
- one fixed shelf
- no profile edge
- locking doors available, specify and add \$105 list

Bookcase with Bottom Doors	16	36	72	170	30	VL3672BCD	\$1,138
<b>NOW!</b>	16	30	72	157	25	VL3072BCD	\$1,078



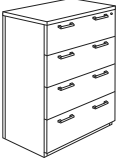
- three adjustable shelves
- one fixed shelf
- no profile edge
- locking doors available, specify and add \$105 list

### To Order, Specify:


- ① Model Number
- ② Laminate Color (see page 38)
  - a.) Chassis Color
  - b.) Door Color
- ③ Pull Style and Color (see page 43)
- ④ Other Product Options (see page 39)

When ordering Quickship products, place a "Q" in front of model number.  
Example: QVL3072DD


**NOW!**  
*Need it.*  
JSI Quickship

Description	D	W	H	CTN WT	CU FT	① Model	TFL List Price	HPL List Price
Lateral File 	24	36	56 <sup>11</sup> / <sub>16</sub>	287	34	VL2436-57LF	\$1,872	\$1,969
	24	30	56 <sup>11</sup> / <sub>16</sub>	270	29	VL2430-57LF	\$1,833	\$1,928
	20	36	56 <sup>11</sup> / <sub>16</sub>	266	29	VL2036-57LF	\$1,797	\$1,892
	20	30	56 <sup>11</sup> / <sub>16</sub>	251	24	VL2030-57LF	\$1,759	\$1,852

- top edge profile on user side
- four drawers
- anti-tip interlock mechanism
- pedestal locking

Lateral File 	24	36	42 <sup>3</sup> / <sub>4</sub>	232	26	VL2436-42LF	\$1,403	\$1,477
	24	30	42 <sup>3</sup> / <sub>4</sub>	218	22	VL2430-42LF	\$1,377	\$1,449
	20	36	42 <sup>3</sup> / <sub>4</sub>	216	22	VL2036-42LF	\$1,347	\$1,417
	20	30	42 <sup>3</sup> / <sub>4</sub>	201	19	VL2030-42LF	\$1,322	\$1,392

- top edge profile on user side
- three drawers
- anti-tip interlock mechanism
- pedestal locking

Lateral File 	24	36	30	192	19	VL2436-30LF	\$1,008	\$1,061
	24	30	30	179	16	VL2430-30LF	\$952	\$1,001
	20	36	30	174	16	VL2036-30LF	\$969	\$1,019
	20	30	30	165	14	VL2030-30LF	\$914	\$961

- top edge profile on user side
- two drawers
- anti-tip interlock mechanism
- pedestal locking

Description	D	W	H	CTN WT	CU FT	① Model	List Price
Box/Box/File Mobile Pedestal	20	16	28	97	8	VL1620MP	\$806

**NOW!**



- box/box/file only
- letter width pedestal
- pedestal front locking
- no additional top needed

							List Price Per Grade
--	--	--	--	--	--	--	-------------------------

Mobile Lateral File with Cushion Top	20	18	21	85	8	VL1820PT	COM \$1,076
							A \$1,086
							B \$1,105
							COL/C \$1,140
							D \$1,184
							E \$1,228
							F \$1,296
							G \$1,370
							H \$1,447
							I \$1,570
							J \$1,716
							L1 \$1,423
							L2 \$1,511

**NOW!**



- soft close hinged top
- legal filing from top
- com ydg: 1

VISION - LAMINATE

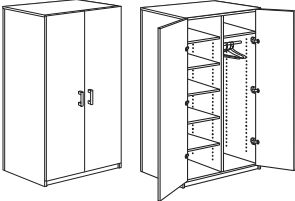
**To Order, Specify:**

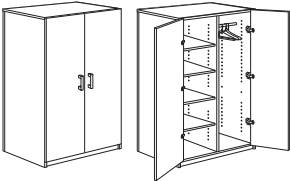
- ① Model Number
- ② Worksurface Material (see page 38)
  - a.) TFL
  - b.) HPL
- ③ Laminate Color (see page 38)
  - a.) Top Color
  - b.) Chassis Color
  - c.) Drawer Color
- ④ Edge Profile (see page 43)
- ⑤ Pull Style and Color (see page 43)
- ⑥ Fabric Selection: vendor, pattern, color
- ⑦ Other Product Options (see page 39)

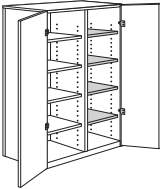
When ordering Quickship products, place a "Q" in front of model number.  
Example: QVL3072DD

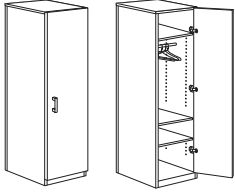




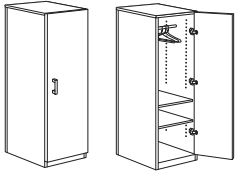
Description	D	W	H	CTN WT	CU FT	① Model	List Price
<b>84" h Wardrobe</b>	24	36	84	264	50	<b>VL2436-84W</b>	<b>\$2,229</b>
<b>NOW!</b>	24	30	84	248	42	<b>VL2430-84W</b>	<b>\$2,114</b>
	20	36	84	230	42	<b>VL2036-84W</b>	<b>\$2,031</b>
	20	30	84	216	36	<b>VL2030-84W</b>	<b>\$1,970</b>
	<ul style="list-style-type: none"> <li>· chrome hanging bar on right</li> <li>· one fixed shelf second from bottom on left</li> <li>· three adjustable shelves</li> <li>· locking doors available, specify and add \$210 list</li> </ul>						

<b>72" h Wardrobe</b>	24	36	72	226	43	<b>VL2436-72W</b>	<b>\$1,938</b>
<b>NOW!</b>	24	30	72	212	36	<b>VL2430-72W</b>	<b>\$1,777</b>
	20	36	72	197	36	<b>VL2036-72W</b>	<b>\$1,741</b>
	20	30	72	185	31	<b>VL2030-72W</b>	<b>\$1,688</b>
	<ul style="list-style-type: none"> <li>· chrome hanging bar on right</li> <li>· one fixed shelf second from bottom on left</li> <li>· three adjustable shelves</li> <li>· locking doors available, specify and add \$210 list</li> </ul>						

<b>Hanging Bar to Shelves Conversion Kit</b> 			$\frac{3}{4}$	18	2	<b>VL1824SK</b>	<b>\$514</b>
			$\frac{3}{4}$	15	2	<b>VL1524SK</b>	<b>\$509</b>
			$\frac{3}{4}$	16	2	<b>VL1820SK</b>	<b>\$489</b>
			$\frac{3}{4}$	14	2	<b>VL1520SK</b>	<b>\$483</b>
<ul style="list-style-type: none"> <li>· four shelves</li> <li>· VL1824SK - for VL2436-84W and VL2436-72W</li> <li>· VL1524SK - for VL2430-84W and VL2430-72W</li> <li>· VL1820SK - for VL2036-84W and VL2036-72W</li> <li>· VL1520SK - for VL2030-84W and VL2030-72W</li> </ul>							

Description	D	W	H	CTN WT	CU FT	① Model	List Price
<b>84" h Wardrobe</b>  right shown	24	18	84	181	26	VL2418-84WR	\$1,490
	24	18	84	181	26	VL2418-84WL	\$1,490
	20	18	84	158	22	VL2018-84WR	\$1,417
	20	18	84	158	22	VL2018-84WL	\$1,417

- chrome hanging bar at top
- one fixed shelf 29" from cabinet floor
- one adjustable shelf
- locking doors available, specify and add \$105 list

<b>72" h Wardrobe</b>  right shown	24	18	72	155	23	VL2418-72WR	\$1,277
	24	18	72	155	23	VL2418-72WL	\$1,277
	20	18	72	135	19	VL2018-72WR	\$1,213
	20	18	72	135	19	VL2018-72WL	\$1,213

- chrome hanging bar at top
- one fixed shelf 29" from cabinet floor
- one adjustable shelf
- locking doors available, specify and add \$105 list

<b>Hanging Bar to Shelves Conversion Kit</b> 	<sup>3</sup> / <sub>4</sub>	16	2	VL1624SK	\$402
	<sup>3</sup> / <sub>4</sub>	14	2	VL1620SK	\$390

- two shelves
- VL1624SK - for VL2418-84WR/WL and VL2418-72WR/WL
- VL1620SK - for VL2018-84WR/WL and VL2018-72WR/WL

**To Order, Specify:**

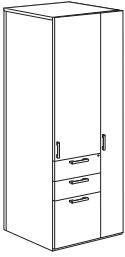
- ① Model Number
- ② Laminate Color (see page 38)
  - a.) Chassis Color
  - b.) Drawer/Door Color
- ③ Pull Style and Color (see page 43)
- ④ Other Product Options (see page 39)

When ordering Quickship products, place a "Q" in front of model number.  
Example: QVL3072DD



Description	D	W	H	CTN WT	CU FT	① Model	List Price
84" h Box/Box/File Storage Wardrobe	24	30	84	311	42	VL2430-84WR	\$2,533
	24	30	84	311	42	VL2430-84WL	\$2,533
	20	30	84	271	36	VL2030-84WR	\$2,406
	20	30	84	271	36	VL2030-84WL	\$2,406

**NOW!**



right shown

- chrome hanging bar
- three adjustable shelves
- locking doors available, specify and add \$210 list
- box/box/file pedestal
- pedestal front locking

72" h Box/Box/File Storage Wardrobe	24	30	72	271	36	VL2430-72WR	\$2,379
	24	30	72	271	36	VL2430-72WL	\$2,379
	20	30	72	236	31	VL2030-72WR	\$2,261
	20	30	72	236	31	VL2030-72WL	\$2,261

**NOW!**



right shown

- chrome hanging bar
- two adjustable shelves
- locking doors available, specify and add \$210 list
- box/box/file pedestal
- pedestal front locking

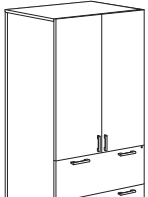
57" h Box/Box/File Storage Wardrobe	24	30	56 <sup>11</sup> / <sub>16</sub>	205	29	VL2430-57WR	\$1,905
	24	30	56 <sup>11</sup> / <sub>16</sub>	205	29	VL2430-57WL	\$1,905
	20	30	56 <sup>11</sup> / <sub>16</sub>	179	24	VL2030-57WR	\$1,811
	20	30	56 <sup>11</sup> / <sub>16</sub>	179	24	VL2030-57WL	\$1,811

**NOW!**



right shown

- chrome hanging bar
- two adjustable shelves
- locking doors available, specify and add \$210 list
- box/box/file pedestal
- pedestal front locking

Description	D	W	H	CTN WT	CU FT	① Model	List Price
<b>84" h File/File Lateral Storage Cabinet</b> 	24	36	84	330	50	VL2436-84FFT	\$2,558
	24	30	84	318	42	VL2430-84FFT	\$2,388
	20	36	84	288	42	VL2036-84FFT	\$2,431
	20	30	84	277	36	VL2030-84FFT	\$2,268

**NOW!**

- three adjustable shelves
- locking doors available, specify and add \$105 list
- file/file lateral
- pedestal locking

<b>72" h File/File Lateral Storage Cabinet</b> 	24	36	72	281	43	VL2436-72FFT	\$2,459
	24	30	72	266	36	VL2430-72FFT	\$2,334
	20	36	72	245	36	VL2036-72FFT	\$2,336
	20	30	72	232	31	VL2030-72FFT	\$2,218

**NOW!**

- two adjustable shelves
- locking doors available, specify and add \$105 list
- file/file lateral
- pedestal locking

<b>57" h File/File Lateral Storage Cabinet</b> 	24	36	56 11/16	216	34	VL2436-57FFT	\$2,037
	24	30	56 11/16	201	29	VL2430-57FFT	\$1,918
	20	36	56 11/16	188	29	VL2036-57FFT	\$1,936
	20	30	56 11/16	175	24	VL2030-57FFT	\$1,822

**NOW!**

- two adjustable shelves
- locking doors available, specify and add \$105 list
- file/file lateral
- pedestal locking

**To Order, Specify:**

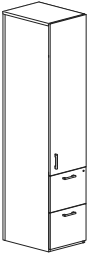
- ① Model Number
- ② Laminate Color (see page 38)
  - a.) Chassis Color
  - b.) Drawer/Door Color
- ③ Pull Style and Color (see page 43)
- ④ Other Product Options (see page 39)

When ordering Quickship products, place a "Q" in front of model number.  
 Example: QVL3072DD

**NOW!**  
*Need it.*  
 JSI Quickship

Description	D	W	H	CTN WT	CU FT	① Model	List Price
84" h File/File Storage Cabinet	24	18	84	205	26	VL2418-84FFTR	\$1,992
	24	18	84	205	26	VL2418-84FFTL	\$1,992
	20	18	84	179	22	VL2018-84FFTR	\$1,893
	20	18	84	179	22	VL2018-84FFTL	\$1,893

**NOW!**



right shown

- three adjustable shelves
- locking doors available, specify and add \$105 list
- file/file pedestal
- pedestal front locking

72" h File/File Storage Cabinet	24	18	72	177	23	VL2418-72FFTR	\$1,843
	24	18	72	177	23	VL2418-72FFTL	\$1,843
	20	18	72	154	19	VL2018-72FFTR	\$1,751
	20	18	72	154	19	VL2018-72FFTL	\$1,751

**NOW!**



right shown

- two adjustable shelves
- locking doors available, specify and add \$105 list
- file/file pedestal
- pedestal front locking

57" h File/File Storage Cabinet	24	18	56 <sup>11</sup> / <sub>16</sub>	130	18	VL2418-57FFTR	\$1,448
	24	18	56 <sup>11</sup> / <sub>16</sub>	130	18	VL2418-57FFTL	\$1,448
	20	18	56 <sup>11</sup> / <sub>16</sub>	114	15	VL2018-57FFTR	\$1,377
	20	18	56 <sup>11</sup> / <sub>16</sub>	114	15	VL2018-57FFTL	\$1,377

**NOW!**

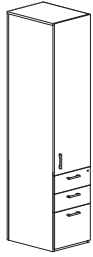


right shown

- two adjustable shelves
- locking doors available, specify and add \$105 list
- file/file pedestal
- pedestal front locking

Description	D	W	H	CTN WT	CU FT	① Model	List Price
84" h Box/Box/File Storage Cabinet	24	18	84	205	26	VL2418-84BBFTR	\$1,999
	24	18	84	205	26	VL2418-84BBFTL	\$1,999
	20	18	84	179	22	VL2018-84BBFTR	\$1,899
	20	18	84	179	22	VL2018-84BBFTL	\$1,899

**NOW!**



right shown

- three adjustable shelves
- locking door available, specify and add \$105 list
- box/box/file pedestal
- pedestal front locking

72" h Box/Box/File Storage Cabinet	24	18	72	177	23	VL2418-72BBFTR	\$1,850
	24	18	72	177	23	VL2418-72BBFTL	\$1,850
	20	18	72	154	19	VL2018-72BBFTR	\$1,757
	20	18	72	154	19	VL2018-72BBFTL	\$1,757

**NOW!**



right shown

- two adjustable shelves
- locking door available, specify and add \$105 list
- box/box/file pedestal
- pedestal front locking

57" h Box/Box/File Storage Cabinet	24	18	56 <sup>11</sup> / <sub>16</sub>	130	18	VL2418-57BBFTR	\$1,478
	24	18	56 <sup>11</sup> / <sub>16</sub>	130	18	VL2418-57BBFTL	\$1,478
	20	18	56 <sup>11</sup> / <sub>16</sub>	114	15	VL2018-57BBFTR	\$1,404
	20	18	56 <sup>11</sup> / <sub>16</sub>	114	15	VL2018-57BBFTL	\$1,404

**NOW!**



right shown

- two adjustable shelves
- locking door available, specify and add \$105 list
- box/box/file pedestal
- pedestal front locking

**To Order, Specify:**

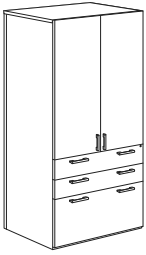
- ① Model Number
- ② Laminate Color (see page 38)
  - a.) Chassis Color
  - b.) Drawer/Door Color
- ③ Pull Style and Color (see page 43)
- ④ Other Product Options (see page 39)

When ordering Quickship products, place a "Q" in front of model number.  
Example: QVL3072DD



Description	D	W	H	CTN WT	CU FT	① Model	List Price
84" h Box/Box/Lateral File Storage Cabinet	24	36	84	335	50	VL2436-84BBFT	\$2,547
	24	30	84	322	42	VL2430-84BBFT	\$2,377
	20	36	84	292	42	VL2036-84BBFT	\$2,421
	20	30	84	281	36	VL2030-84BBFT	\$2,259

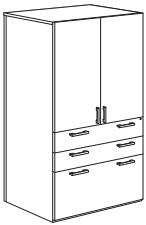
**NOW!**



- three adjustable shelves
- locking doors available, specify and add \$105 list
- box/box/lateral file
- pedestal locking

72" h Box/Box/Lateral File Storage Cabinet	24	36	72	285	43	VL2436-72BBFT	\$2,446
	24	30	72	271	36	VL2430-72BBFT	\$2,322
	20	36	72	248	36	VL2036-72BBFT	\$2,324
	20	30	72	236	31	VL2030-72BBFT	\$2,207

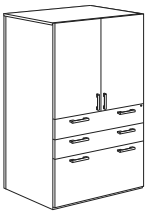
**NOW!**



- two adjustable shelves
- locking doors available, specify and add \$105 list
- box/box/file lateral
- pedestal locking

57" h Box/Box/Lateral File Storage Cabinet	24	36	56 <sup>11</sup> / <sub>16</sub>	216	34	VL2436-57BBFT	\$2,026
	24	30	56 <sup>11</sup> / <sub>16</sub>	201	29	VL2430-57BBFT	\$1,903
	20	36	56 <sup>11</sup> / <sub>16</sub>	188	29	VL2036-57BBFT	\$1,925
	20	30	56 <sup>11</sup> / <sub>16</sub>	175	24	VL2030-57BBFT	\$1,810

**NOW!**



- two adjustable shelves
- locking doors available, specify and add \$105 list
- box/box/file lateral
- pedestal locking

Description	D	W	H	CTN WT	CU FT	① Model	List Price
84" h Multi-File Storage Cabinet	24	30	84	344	42	VL2430-84MFR	\$2,399
	24	30	84	344	42	VL2430-84MFL	\$2,399
	20	30	84	300	36	VL2030-84MFR	\$2,280
	20	30	84	300	36	VL2030-84MFL	\$2,280

**NOW!**



right shown

- three adjustable shelves
- locking doors available, specify and add \$105 list
- pedestal locking

72" h Multi-File Storage Cabinet	24	30	72	331	36	VL2430-72MFR	\$2,340
	24	30	72	331	36	VL2430-72MFL	\$2,340
	20	30	72	288	31	VL2030-72MFR	\$2,223
	20	30	72	288	31	VL2030-72MFL	\$2,223

**NOW!**

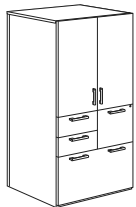


right shown

- two adjustable shelves
- locking doors available, specify and add \$105 list
- pedestal locking

57" h Multi-File Storage Cabinet	24	30	56 <sup>11</sup> / <sub>16</sub>	216	34	VL2430-57MFR	\$2,147
	24	30	56 <sup>11</sup> / <sub>16</sub>	216	34	VL2430-57MFL	\$2,147
	20	30	56 <sup>11</sup> / <sub>16</sub>	188	29	VL2030-57MFR	\$2,040
	20	30	56 <sup>11</sup> / <sub>16</sub>	188	29	VL2030-57MFL	\$2,040

**NOW!**



right shown

- two adjustable shelves
- locking doors available, specify and add \$105 list
- pedestal locking

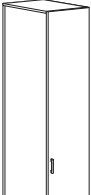
**To Order, Specify:**

- ① Model Number
- ② Laminate Color (see page 38)
  - a.) Chassis Color
  - b.) Drawer/Door Color
- ③ Pull Style and Color (see page 43)
- ④ Other Product Options (see page 39)

When ordering Quickship products, place a "Q" in front of model number.  
Example: QVL3072DD

**NOW!**  
*Need it.*  
JSI Quickship



Description	D	W	H	CTN WT	CU FT	① Model	List Price
84" h Storage Cabinet 	24	18	84	137	26	VL2418-84HR	\$1,502
	24	18	84	137	26	VL2418-84HL	\$1,502
	20	18	84	120	22	VL2018-84HR	\$1,427
	20	18	84	120	22	VL2018-84HL	\$1,427

**NOW!**

right shown


- one fixed shelf 29 1/2" from cabinet floor
- four adjustable shelves
- locking doors available, specify and add \$105 list

72" h Storage Cabinet 	24	18	72	165	23	VL2418-72HR	\$1,289
	24	18	72	165	23	VL2418-72HL	\$1,289
	20	18	72	144	19	VL2018-72HR	\$1,225
	20	18	72	144	19	VL2018-72HL	\$1,225

**NOW!**

right shown

- one fixed shelf 29 1/2" from cabinet floor
- three adjustable shelves
- locking doors available, specify and add \$105 list

57" h Storage Cabinet 	24	18	56 11/16	117	18	VL2418-57HR	\$1,139
	24	18	56 11/16	117	18	VL2418-57HL	\$1,139
	20	18	56 11/16	102	15	VL2018-57HR	\$1,082
	20	18	56 11/16	102	15	VL2018-57HL	\$1,082

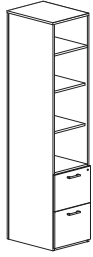
**NOW!**

right shown

- three adjustable shelves
- locking doors available, specify and add \$105 list

Description	D	W	H	CTN WT	CU FT	① Model	List Price
84" h Open Top, File/File Storage Cabinet	24	18	84	197	26	VL2418-84FFO	\$1,918
	20	18	84	172	22	VL2018-84FFO	\$1,822

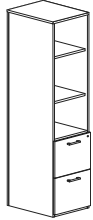
**NOW!**



- two adjustable shelves, top shelf fixed
- file/file pedestal
- pedestal front locking

72" h Open Top, File/File Storage Cabinet	24	18	72	185	23	VL2418-72FFO	\$1,769
	20	18	72	161	19	VL2018-72FFO	\$1,680

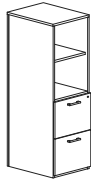
**NOW!**



- two adjustable shelves
- file/file pedestal
- pedestal front locking

57" h Open Top, File/File Storage Cabinet	24	18	56 11/16	125	18	VL2418-57FFO	\$1,413
	20	18	56 11/16	109	15	VL2018-57FFO	\$1,342

**NOW!**



- one adjustable shelf
- file/file pedestal
- pedestal front locking

**To Order, Specify:**

- ① Model Number
- ② Laminate Color (see page 38)
  - a.) Chassis Color
  - b.) Drawer/Door Color
- ③ Pull Style and Color (see page 43)
- ④ Other Product Options (see page 39)

When ordering Quickship products, place a "Q" in front of model number.  
Example: QVL3072DD

**NOW!**  
*Need it.*  
JSI Quickship

Description	D	W	H	CTN WT	CU FT	① Model	List Price
84" h Open Top, Box/Box/File Storage Cabinet	24	18	84	197	26	VL2418-84BBFO	\$1,930
	20	18	84	172	22	VL2018-84BBFO	\$1,834

**NOW!**

- two adjustable shelves, top shelf fixed
- box/box/file pedestal
- pedestal front locking



72" h Open Top, Box/Box/File Storage Cabinet	24	18	72	185	23	VL2418-72BBFO	\$1,781
	20	18	72	161	19	VL2018-72BBFO	\$1,692

**NOW!**

- two adjustable shelves
- box/box/file pedestal
- pedestal front locking

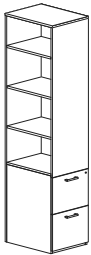


57" h Open Top, Box/Box/File Storage Cabinet	24	18	56 <sup>11</sup> / <sub>16</sub>	125	18	VL2418-57BBFO	\$1,425
	20	18	56 <sup>11</sup> / <sub>16</sub>	109	15	VL2018-57BBFO	\$1,355


**NOW!**

- one adjustable shelf
- box/box/file pedestal
- pedestal front locking




Description	D	W	H	CTN WT	CU FT	① Model	List Price
84" h File/File Storage Cabinet with Side Access	24	18	84	197	26	VL2418-84FFSSTR	\$1,931
	24	18	84	197	26	VL2418-84FFSSTL	\$1,931
 right shown ▲	20	18	84	172	22	VL2018-84FFSSTR	\$1,835
	20	18	84	172	22	VL2018-84FFSSTL	\$1,835

- two adjustable shelves, top shelf fixed
- file/file pedestal
- pedestal front locking

72" h File/File Storage Cabinet with Side Access	24	18	72	185	23	VL2418-72FFSSTR	\$1,781
	24	18	72	185	23	VL2418-72FFSSTL	\$1,781
 right shown ▲	20	18	72	161	19	VL2018-72FFSSTR	\$1,692
	20	18	72	161	19	VL2018-72FFSSTL	\$1,692

- two adjustable shelves
- file/file pedestal
- pedestal front locking

57" h File/File Storage Cabinet with Side Access	24	18	56 <sup>11</sup> / <sub>16</sub>	125	18	VL2418-57FFSSTR	\$1,418
	24	18	56 <sup>11</sup> / <sub>16</sub>	125	18	VL2418-57FFSSTL	\$1,418
 right shown ▲	20	18	56 <sup>11</sup> / <sub>16</sub>	109	15	VL2018-57FFSSTR	\$1,348
	20	18	56 <sup>11</sup> / <sub>16</sub>	109	15	VL2018-57FFSSTL	\$1,348

- one adjustable shelf
- file/file pedestal
- pedestal front locking

**To Order, Specify:**

- ① Model Number
- ② Laminate Color (see page 38)
  - a.) Chassis Color
  - b.) Drawer Color
- ③ Pull Style and Color (see page 43)
- ④ Other Product Options (see page 39)

When ordering Quickship products, place a "Q" in front of model number.  
Example: QVL3072DD



Description	D	W	H	CTN WT	CU FT	① Model	List Price
84" h Box/Box/File Storage Cabinet with Side Access	24	18	84	197	26	VL2418-84BBFSSTR	\$1,944
	24	18	84	197	26	VL2418-84BBFSSTL	\$1,944
	20	18	84	172	22	VL2018-84BBFSSTR	\$1,848
	20	18	84	172	22	VL2018-84BBFSSTL	\$1,848

**NOW!**



- two adjustable shelves, top shelf fixed
- box/box/file pedestal
- pedestal front locking

right shown ▲

72" h Box/Box/File Storage Cabinet with Side Access	24	18	72	185	23	VL2418-72BBFSSTR	\$1,794
	24	18	72	185	23	VL2418-72BBFSSTL	\$1,794
	20	18	72	161	19	VL2018-72BBFSSTR	\$1,706
	20	18	72	161	19	VL2018-72BBFSSTL	\$1,706

**NOW!**



- two adjustable shelves
- box/box/file pedestal
- pedestal front locking

right shown ▲

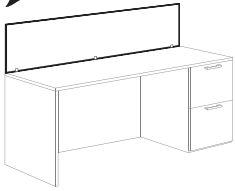
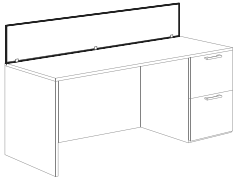
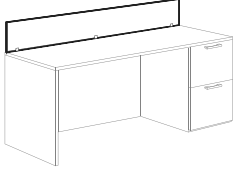
57" h Box/Box/File Storage Cabinet with Side Access	24	18	56 <sup>11</sup> / <sub>16</sub>	125	18	VL2418-57BBFSSTR	\$1,431
	24	18	56 <sup>11</sup> / <sub>16</sub>	125	18	VL2418-57BBFSSTL	\$1,431
	20	18	56 <sup>11</sup> / <sub>16</sub>	109	15	VL2018-57BBFSSTR	\$1,359
	20	18	56 <sup>11</sup> / <sub>16</sub>	109	15	VL2018-57BBFSSTL	\$1,359

**NOW!**



- one adjustable shelf
- box/box/file pedestal
- pedestal front locking

right shown ▲

Description	D	W	H	CTN WT	CU FT	① Model	List Price
<b>Rectangle Privacy Screen</b> 	1/4	71 1/4	15	7	3	VS1572ASR	\$691
	1/4	65 1/4	15	7	2	VS1566ASR	\$641
	1/4	59 1/4	15	6	2	VS1560ASR	\$591
	1/4	53 1/4	15	6	2	VS1554ASR	\$543
	1/4	47 1/4	15	6	2	VS1548ASR	\$494
	1/4	41 1/4	15	5	2	VS1542ASR	\$447
	1/4	35 1/4	15	5	1	VS1536ASR	\$389
	1/4	29 1/4	15	4	1	VS1530ASR	\$342
	1/4	23 1/4	15	4	1	VS1524ASR	\$293
	1/4	71 1/4	12	7	2	VS1272ASR	\$570
	1/4	65 1/4	12	7	2	VS1266ASR	\$530
	1/4	59 1/4	12	6	2	VS1260ASR	\$489
	1/4	53 1/4	12	6	2	VS1254ASR	\$451
	1/4	47 1/4	12	6	2	VS1248ASR	\$412
	1/4	41 1/4	12	5	2	VS1242ASR	\$374
	1/4	35 1/4	12	5	1	VS1236ASR	\$325
	1/4	29 1/4	12	4	1	VS1230ASR	\$287
	1/4	23 1/4	12	4	1	VS1224ASR	\$248
	1/4	71 1/4	9	6	2	VS0972ASR	\$511
	1/4	65 1/4	9	6	2	VS0966ASR	\$475
	1/4	59 1/4	9	5	2	VS0960ASR	\$439
	1/4	53 1/4	9	5	2	VS0954ASR	\$406
	1/4	47 1/4	9	5	1	VS0948ASR	\$371
	1/4	41 1/4	9	5	1	VS0942ASR	\$338
	1/4	35 1/4	9	4	1	VS0936ASR	\$294
	1/4	29 1/4	9	4	1	VS0930ASR	\$261
	1/4	23 1/4	9	4	1	VS0924ASR	\$227

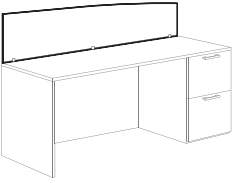
- frosted acrylic
- mounts to top of worksurface
- mounting hardware included
- field installed

**To Order, Specify:**

- ① Model Number
- ② Laminate Color (see page 38)
  - a.) Chassis Color
  - b.) Drawer/Door Color
- ③ Pull Style and Color (see page 43)
- ④ Other Product Options (see page 39)

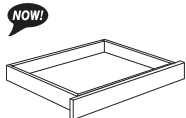
When ordering Quickship products, place a "Q" in front of model number.  
 Example: QVL3072DD



Description	D	W	H	CTN WT	CU FT	① Model	List Price
Fin Privacy Screen 	1/4	71 1/4	15	7	3	VS1572ASF	\$793
	1/4	65 1/4	15	7	2	VS1566ASF	\$745
	1/4	59 1/4	15	6	2	VS1560ASF	\$695
	1/4	53 1/4	15	6	2	VS1554ASF	\$646
	1/4	47 1/4	15	6	2	VS1548ASF	\$598
	1/4	41 1/4	15	5	2	VS1542ASF	\$524
	1/4	35 1/4	15	5	1	VS1536ASF	\$467
	1/4	29 1/4	15	4	1	VS1530ASF	\$419
	1/4	23 1/4	15	4	1	VS1524ASF	\$371
	1/4	71 1/4	12	7	3	VS1272ASF	\$674
	1/4	65 1/4	12	7	2	VS1266ASF	\$634
	1/4	59 1/4	12	6	2	VS1260ASF	\$593
	1/4	53 1/4	12	6	2	VS1254ASF	\$555
	1/4	47 1/4	12	6	2	VS1248ASF	\$516
	1/4	41 1/4	12	5	2	VS1242ASF	\$452
	1/4	35 1/4	12	5	1	VS1236ASF	\$404
1/4	29 1/4	12	4	1	VS1230ASF	\$366	
1/4	23 1/4	12	4	1	VS1224ASF	\$327	

- arc spans 12" to 15" for 15" high and 9" to 12" for 12" high
- frosted acrylic
- mounts to top of worksurface
- mounting hardware included
- field installed

Center Drawer	18	27	2 1/2	12	2	VL1825CD	\$284
---------------	----	----	-------	----	---	----------	-------



- interior dimensions 22 3/4" wide X 15 1/2" deep X 2 1/8" high
- drawer front 27" wide
- field installed
- locking not available
- mounts to bottom of worksurface
- available on any double or single pedestal desk, not available on cockpit or peninsula desks

### To Order, Specify:

- ① Model Number
- ② Laminate Color (see page 38)

When ordering Quickship products, place a "Q" in front of model number.  
Example: QVL3072DD

**NOW!**  
Need it.  
JSI Quickship

Vision - Laminate - Notes







Desks . . . . .	252	Wall Mount Storage . . . . .	339
Modesty Panels . . . . .	255	Overhead Bookcases . . . . .	358
Peninsula Desks . . . . .	263	Storage Tower Applications . . . . .	359
Desk Bases . . . . .	265	Overhead Bridge Storage. . . . .	364
Returns . . . . .	266	Transaction Applications . . . . .	368
Bridges . . . . .	276	Bench Height Applications . . . . .	369
Credenzas . . . . .	278	Freestanding Bench Height Cabinets . . .	372
Modular Tops . . . . .	282	Modular Bench Height Cabinets . . . . .	380
Modular Supports . . . . .	282	Modular Tops . . . . .	382
Modular Pedestals . . . . .	287	Bench Height Seat Cushions. . . . .	384
Support Applications. . . . .	288	Bookcases. . . . .	386
Modesty Panel Applications . . . . .	290	Lateral Files . . . . .	388
Overhead Cabinets. . . . .	292	Wardrobes. . . . .	390
Overhead Cabinet Post Supports . . . . .	328	Storage Cabinets . . . . .	392
Tackboards . . . . .	306	Privacy Screens . . . . .	403
Accessories . . . . .	318		

# Vision - Veneer - Overview

## Desks



**Bow Front Double Pedestal**  
Page 252



**Double Pedestal**  
Page 253



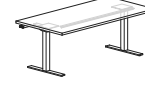
**Double Pedestal**  
Page 253



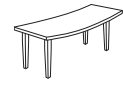
**Electric Adjustable Height Table Desk**  
Page 256



**Pneumatic Adjustable Height Table Desk**  
Page 256

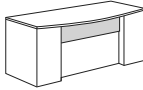


**Crank Adjustable Height Table Desk**  
Page 256

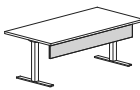


**Table Desk**  
Page 257

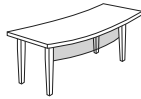
## Modesty Panels



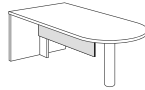
**Trim Modesty Panel**  
Page 255



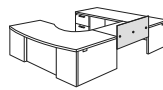
**Adjustable Table Modesty Panel**  
Page 257



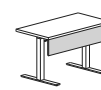
**Trim Modesty Panel**  
Page 257



**Trim Modesty Panel for Peninsula Tops**  
Page 265



**Bridge Panel Screen**  
Page 276

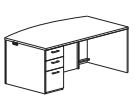


**Adjustable Height Bridge Modesty Panel**  
Page 277

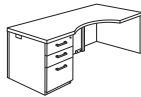
## Desk Applications



**Bow Front Cockpit Pedestal Desk**  
Page 258



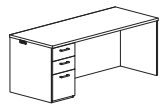
**Bow Front Pedestal Desk**  
Page 259



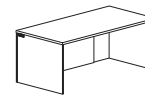
**Cockpit Pedestal Desk**  
Page 260



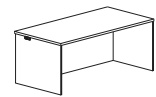
**Pedestal Desk**  
Page 261



**Pedestal Desk**  
Page 261

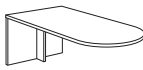


**Shell Desk**  
Page 262



**Shell Desk**  
Page 262

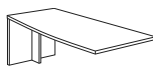
## Peninsula Desks



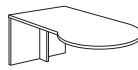
**Bullet Desk**  
Page 263



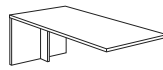
**Cockpit Bullet Desk**  
Page 263



**Fin Desk**  
Page 264

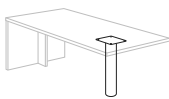


**P-Top Desk**  
Page 264

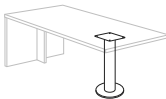


**Rectangle Desk**  
Page 264

## Peninsula Desk Bases and Bullet Return Bases



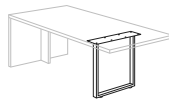
**Column Base**  
Page 265



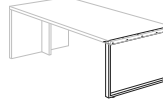
**Column Disk Base**  
Page 265



**H Base**  
Page 265



**U Base**  
Page 265



**Rectangular Base** ▲  
Page 265

## Return Applications



**File/File Return**  
Page 266



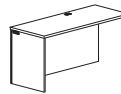
**Box/Box/File Return**  
Page 267



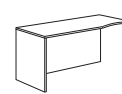
**Lateral File Return**  
Page 268



**Multi-File Return**  
Page 268



**Shell Return**  
Page 269



**Cockpit Shell Return**  
Page 270



**Bullet Return**  
Page 270



**File/File Corner Return**  
Page 272



**Box/Box/File Corner Return**  
Page 273



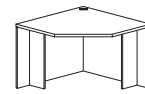
**Lateral File Corner Return**  
Page 274



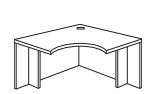
**Multi-File Corner Return**  
Page 274



**Shell Corner Return**  
Page 275

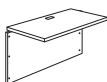


**Corner Unit**  
Page 271



**Cockpit Corner Unit**  
Page 271

## Bridge Applications



**48", 42" and 36" Executive Bridge**  
Page 276



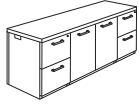
**Electric Adjustable Height Bridge**  
Page 277



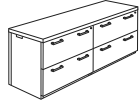
**Pneumatic Adjustable Height Bridge**  
Page 277

## Vision - Veneer - Overview

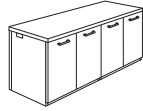
### Credenzas



Storage Credenza  
Page 278



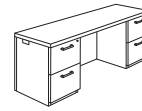
Lateral File Credenza  
Page 278



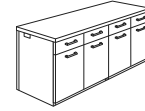
Four Door Credenza  
Page 278



Two Door Credenza  
Page 278



Kneespace Credenza  
Page 279

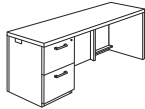


Buffet Credenza  
Page 279

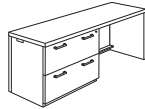


Buffet Credenza  
Page 279

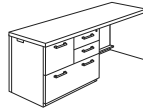
### Credenza Applications



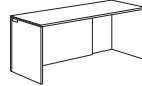
File/File Pedestal  
Credenza  
Page 280



Lateral File Pedestal  
Credenza  
Page 280



Multi-File Pedestal  
Credenza  
Page 281

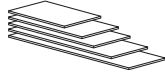


Shell Credenza  
Page 281

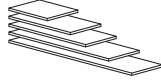
### Modular Top



Modular Bow Front  
Top  
Page 282



Modular Rectangular  
Desk Top  
Page 282



Modular Credenza Top  
Page 283



Modular Extended  
Corner Credenza Top  
Page 284



Modular Return/Bridge  
Top  
Page 284



Modular Extended  
Corner Bullet Top  
Page 285



Modular Extended  
Corner Top  
Page 285



Modular Bullet Top  
Page 286



Modular Boomerang  
Top  
Page 286

### Modular Supports



Metal Legs  
Page 282



Metal Legs  
with Casters  
Page 282



L-Bracket  
Page 282



Full Height T-Support  
Page 286



Bench Height T-Support  
Page 286

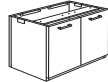
### Modular Pedestal



Modular Box/Box/  
File Pedestal  
Page 287



Modular File/File  
Pedestal  
Page 287



Modular Hinged  
Door Pedestal  
Page 287



Modular Buffet  
Pedestal  
Page 288

### Modular Pedestals



Modular Lateral File  
Pedestal  
Page 288

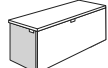


Modular Multi-File  
Pedestal  
Page 288

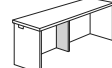
### Support Applications



Wing End Support  
Page 288



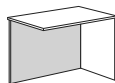
Modular End Panel  
Support  
Page 289



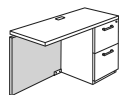
Modular Center  
Support Panel  
Page 290

# Vision - Veneer - Overview

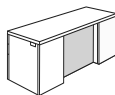
## Modesty Panel Applications



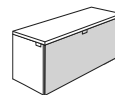
Modular Shell Return  
Modesty Panel  
Page 290



Modular Return  
Modesty Panel  
Page 290

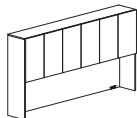


Modular Break Front Desk  
and Credenza Modesty Panel  
Page 291

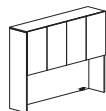


Modular Desk and Credenza  
Shell Modesty Panel  
Page 291

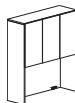
## Overhead Cabinets



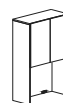
Double Height Storage Overhead  
Cabinet w/Six Doors  
Page 292



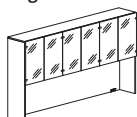
Double Height Storage Overhead  
Cabinet w/Four Doors  
Page 292



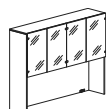
Double Height Storage Overhead  
Cabinet w/Three Doors  
Page 292



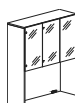
Double Height Storage Overhead  
Cabinet w/Two Doors  
Page 292



Double Height Storage Overhead  
Cabinet w/Six Glass Doors  
Page 294



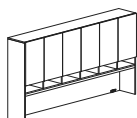
Double Height Storage Overhead  
Cabinet w/Four Glass Doors  
Page 294



Double Height Storage Overhead  
Cabinet w/Three Glass Doors  
Page 294



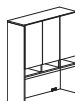
Double Height Storage Overhead  
Cabinet w/Two Glass Doors  
Page 294



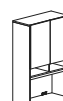
Double Height Storage Overhead  
Cabinet w/Six Doors and Cubbies  
Page 295



Double Height Storage Overhead  
Cabinet w/Four Doors and Cubbies  
Page 295



Double Height Storage Overhead  
Cabinet w/Three Doors and Cubbies  
Page 295



Double Height Storage Overhead  
Cabinet w/Two Doors and Cubbies  
Page 296



Double Height Storage Overhead  
Cabinet w/Six Glass Doors  
and Cubbies  
Page 297



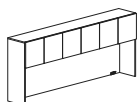
Double Height Storage Overhead  
Cabinet w/Four Glass Doors  
and Cubbies  
Page 297



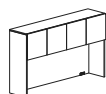
Double Height Storage Overhead  
Cabinet w/Three Glass Doors  
and Cubbies  
Page 297



Double Height Storage Overhead  
Cabinet w/Two Glass Doors  
and Cubbies  
Page 298



Storage Overhead Cabinet  
w/Six Doors  
Page 298



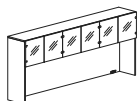
Storage Overhead Cabinet  
w/Four Doors  
Page 298



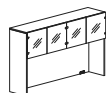
Storage Overhead Cabinet  
w/Three Doors  
Page 298



Storage Overhead Cabinet  
w/Two Doors  
Page 298



Storage Overhead Cabinet  
w/Six Glass Doors  
Page 300



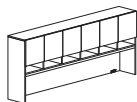
Storage Overhead Cabinet  
w/Four Glass Doors  
Page 300



Storage Overhead Cabinet  
w/Three Glass Doors  
Page 300



Storage Overhead Cabinet  
w/Two Glass Doors  
Page 300



Storage Overhead Cabinet  
w/Six Doors and Cubbies  
Page 301



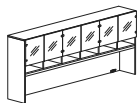
Storage Overhead Cabinet  
w/Four Doors and Cubbies  
Page 301



Storage Overhead Cabinet  
w/Three Doors and Cubbies  
Page 301



Storage Overhead Cabinet  
w/Two Doors and Cubbies  
Page 302



Storage Overhead Cabinet  
w/Six Glass Doors and Cubbies  
Page 303



Storage Overhead Cabinet  
w/Four Glass Doors and Cubbies  
Page 303



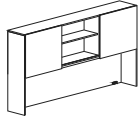
Storage Overhead Cabinet  
w/Three Glass Doors and Cubbies  
Page 303



Storage Overhead Cabinet  
w/Two Glass Doors and Cubbies  
Page 304

# Vision - Veneer - Overview

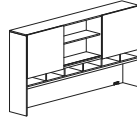
## Overhead Cabinets (continued)



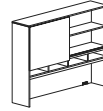
Double Height Storage Overhead Cabinet w/Two Sliding Doors  
Page 293



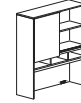
Double Height Storage Overhead Cabinet w/Sliding Door  
Page 293



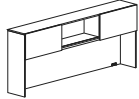
Double Height Storage Overhead Cabinet w/Two Sliding Doors and Cubbies  
Page 296



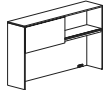
Double Height Storage Overhead Cabinet w/Sliding Door and Cubbies  
Page 296



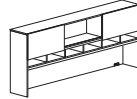
Double Height Storage Overhead Cabinet w/Sliding Door and Cubbies  
Page 296



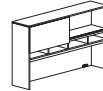
Storage Overhead Cabinet w/Two Sliding Doors  
Page 299



Storage Overhead Cabinet w/Sliding Door  
Page 299



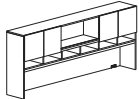
Storage Overhead Cabinet w/Sliding Doors and Cubbies  
Page 302



Storage Overhead Cabinet w/Sliding Door and Cubbies  
Page 302



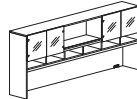
Storage Overhead Cabinet w/Sliding Door and Cubbies  
Page 302



Storage Overhead Cabinet w/Four Doors, Open Center Shelf and Cubbies  
Page 304



Storage Overhead Cabinet w/Two Doors, Open Center Shelf and Cubbies  
Page 304

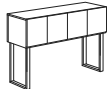


Storage Overhead Cabinet w/Four Glass Door, Open Center Shelf and Cubbies  
Page 305

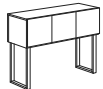


Storage Overhead Cabinet w/Two Glass Door, Open Center Shelf and Cubbies  
Page 305

## Post Support Overhead Cabinets



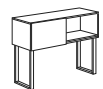
37", 27" and Split Height w/Four Hinged Doors  
Pages 328-330



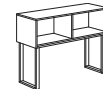
37", 27" and Split Height w/Three Hinged Doors  
Pages 328-330



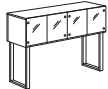
37", 27" and Split Height w/Two Hinged Doors  
Pages 328-330



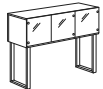
37", 27" and Split Height w/Sliding Door  
Page 331



37", 27" and Split Height Open  
Page 332



37", 27" and Split Height w/Four Glass Doors  
Pages 333-335

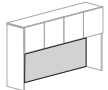


37", 27" and Split Height w/Three Glass Doors  
Pages 333-335

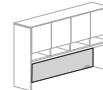


37", 27" and Split Height w/Two Glass Doors  
Pages 333-335

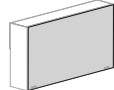
## Tackboards



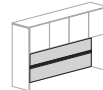
Tackboard for Front of Storage Overhead Cabinet  
Pages 306-309



Tackboard for Front of Storage Overhead Cabinet w/Cubbies  
Pages 310-313



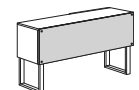
Tackboard for Back of Storage Overhead Cabinet  
Pages 314-316



Accessory Rail Tackboard for Storage Overhead Cabinet  
Pages 320-323



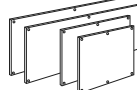
Accessory Rail Tackboard for Storage Overhead Cabinet w/Cubbies  
Pages 324-327



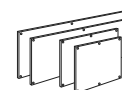
Tackboard for Back of Post Support Overhead Cabinet  
Pages 336-338



Fabric Back Panel for Storage Tower  
Page 363



Wall Mount Tackboards  
Pages 353-355



Wall Mount Tackboards for Overhead Cabinets w/Cubbies  
Pages 356-358

## Accessories



Accessory Rail  
Page 318



Upright Tray  
Page 319



Small Tray  
Page 319



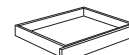
Pencil Tray  
Page 319



Paper Tray  
Page 319



File Hanger  
Page 319



Center Drawer  
Page 404

# Vision - Veneer - Overview

## Wall Mount Storage



Double Height Wall Mount Overhead Shelf  
Page 364



Double Height Wall Mount Open Overhead  
Page 364

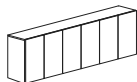


Wall Mount Overhead Shelf  
Page 366

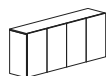


Wall Mount Open Overhead  
Page 366

## Wall Mount Storage



Double Height Wall Mount Overhead Cabinet w/Six Doors  
Page 340



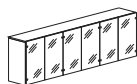
Double Height Wall Mount Overhead Cabinet w/Four Doors  
Page 340



Double Height Wall Mount Overhead Cabinet w/Three Doors  
Page 340



Double Height Wall Mount Overhead Cabinet w/Two Doors  
Page 340



Double Height Wall Mount Overhead Cabinet w/Six Glass Doors  
Page 342



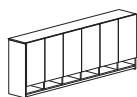
Double Height Wall Mount Overhead Cabinet w/Four Glass Doors  
Page 342



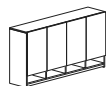
Double Height Wall Mount Overhead Cabinet w/Three Glass Doors  
Page 342



Double Height Wall Mount Overhead Cabinet w/Two Glass Doors  
Page 342



Double Height Wall Mount Overhead Cabinet w/Six Doors and Cubbies  
Page 343



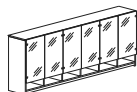
Double Height Wall Mount Overhead Cabinet w/Four Doors and Cubbies  
Page 343



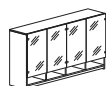
Double Height Wall Mount Overhead Cabinet w/Three Doors and Cubbies  
Page 343



Double Height Wall Mount Overhead Cabinet w/Two Doors and Cubbies  
Page 343



Double Height Wall Mount Overhead Cabinet w/Six Glass Doors and Cubbies  
Page 345



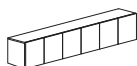
Double Height Wall Mount Overhead Cabinet w/Four Glass Doors and Cubbies  
Page 345



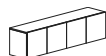
Double Height Wall Mount Overhead Cabinet w/Three Glass Doors and Cubbies  
Page 345



Double Height Wall Mount Overhead Cabinet w/Two Glass Doors and Cubbies  
Page 345



Wall Mount Overhead Cabinet w/Six Doors  
Page 346



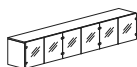
Wall Mount Overhead Cabinet w/Four Doors  
Page 346



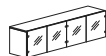
Wall Mount Overhead Cabinet w/Three Doors  
Page 346



Wall Mount Overhead Cabinet w/Two Doors  
Page 346



Wall Mount Overhead Cabinet w/Six Glass Doors  
Page 348



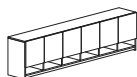
Wall Mount Overhead Cabinet w/Four Glass Doors  
Page 348



Wall Mount Overhead Cabinet w/Three Glass Doors  
Page 348



Wall Mount Overhead Cabinet w/Two Glass Doors  
Page 348



Wall Mount Overhead Cabinet w/Six Doors and Cubbies  
Page 349



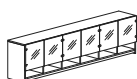
Wall Mount Overhead Cabinet w/Four Doors and Cubbies  
Page 349



Wall Mount Overhead Cabinet w/Three Doors and Cubbies  
Page 349



Wall Mount Overhead Cabinet w/Two Doors and Cubbies  
Page 349



Wall Mount Overhead Cabinet w/Six Glass Doors and Cubbies  
Page 351



Wall Mount Overhead Cabinet w/Four Glass Doors and Cubbies  
Page 351



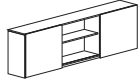
Wall Mount Overhead Cabinet w/Three Glass Doors and Cubbies  
Page 351



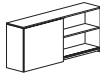
Wall Mount Overhead Cabinet w/Two Glass Doors and Cubbies  
Page 351

# Vision - Veneer - Overview

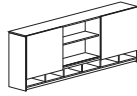
## Overhead Cabinets (continued)



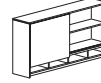
Double Height Wall Mount Overhead Cabinet w/Two Sliding Doors  
Page 341



Double Height Wall Mount Overhead Cabinet w/Sliding Door  
Page 341



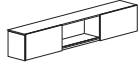
Double Height Wall Mount Overhead Cabinet w/Two Sliding Doors and Cubbies  
Page 344



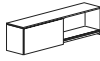
Double Height Wall Mount Overhead Cabinet w/Sliding Door and Cubbies  
Page 344



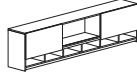
Double Height Wall Mount Overhead Cabinet w/Sliding Door and Cubbies  
Page 344



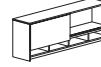
Wall Mount Overhead Cabinet w/Two Sliding Doors  
Page 347



Wall Mount Overhead Cabinet w/Sliding Door  
Page 347



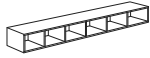
Wall Mount Overhead Cabinet w/Two Sliding Doors and Cubbies  
Page 350



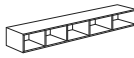
Wall Mount Overhead Cabinet w/Sliding Door and Cubbies  
Page 350



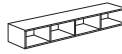
Wall Mount Overhead Cabinet w/Sliding Door and Cubbies  
Page 350



Wall Mount Cubby Six Compartments  
Page 352



Wall Mount Cubby Five Compartments  
Page 352



Wall Mount Cubby Four Compartments  
Page 352

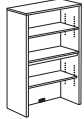


Wall Mount Cubby Three Compartments  
Page 352

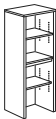


Wall Mount Cubby Two Compartments  
Page 352

## Overhead Bookcase



Double Height Bookcase Overhead  
Page 358



Double Height Bookcase Overhead  
Page 358

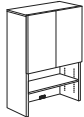


Bookcase Overhead  
Page 360

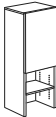


Bookcase Overhead  
Page 360

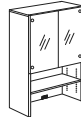
## Storage Tower Applications



Double Height Storage Tower w/29" h Doors  
Page 359



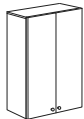
Double Height Storage Tower w/29" h Door  
Page 359



Double Height Storage Tower w/29" h Glass Doors  
Page 359



Double Height Storage Tower w/29" h Glass Door  
Page 359



Double Height Storage Tower w/54" h Doors  
Page 360



Double Height Storage Tower w/54" h Door  
Page 360



Double Height Storage Tower w/54" h Glass Doors  
Page 360



Double Height Storage Tower w/54" h Glass Door  
Page 360



Storage Tower w/17" h Doors  
Page 361



Storage Tower w/17" h Door  
Page 361



Storage Tower w/17" h Glass Doors  
Page 361



Storage Tower w/17" h Glass Door  
Page 361



Storage Tower w/42" h Doors  
Page 362



Storage Tower w/42" h Door  
Page 362



Storage Tower w/42" h Glass Doors  
Page 362



Storage Tower w/42" h Glass Door  
Page 362



# Vision - Veneer - Overview

## Overhead Bridge Applications



Double Height Bridge Mount Overhead Shelf  
Page 364



Double Height Bridge Mount Open Overhead  
Page 364



Bridge Mount Overhead Shelf  
Page 366



Bridge Mount Open Overhead  
Page 366

## Overhead Bridge Applications



Double Height Bridge Mount Overhead Cabinet w/Four Doors  
Page 364



Double Height Bridge Mount Overhead Cabinet w/Three Doors  
Page 364



Double Height Bridge Mount Overhead Cabinet w/Two Doors  
Page 364



Double Height Bridge Mount Overhead Cabinet w/Sliding Door  
Page 364



Double Height Bridge Mount Overhead Cabinet w/Four Glass Doors  
Page 365



Double Height Bridge Mount Overhead Cabinet w/Three Glass Doors  
Page 365



Double Height Bridge Mount Overhead Cabinet w/Two Glass Doors  
Page 365



Bridge Mount Overhead Cabinet w/Four Doors  
Page 366



Bridge Mount Overhead Cabinet w/Three Doors  
Page 366



Bridge Mount Overhead Cabinet w/Two Doors  
Page 366



Bridge Mount Overhead Cabinet w/Sliding Door  
Page 366



Bridge Mount Overhead Cabinet w/Four Glass Doors  
Page 367



Bridge Mount Overhead Cabinet w/Three Glass Doors  
Page 367



Bridge Mount Overhead Cabinet w/Two Glass Doors  
Page 367

## Storage Tower Insert/Transaction Support



Horizontal Sorter  
Page 368



Vertical Sorter  
Page 368

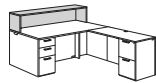
## Transaction Surfaces



Transaction Surface  
Page 368

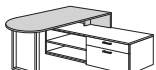


Transaction Trim Panel  
Page 368

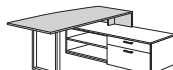


Transaction Counter  
Page 368

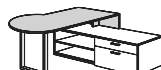
## Peninsula Desks for Bench Height



Bullet Desk  
Page 369



Fin Desk  
Page 369

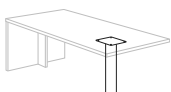


P-Top Desk  
Page 370

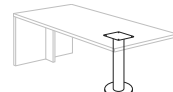


Rectangle Desk  
Page 370

## Peninsula Desk Bases for Bench Height



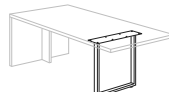
Column Base  
Page 371



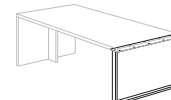
Column Disk Base  
Page 371



H Base  
Page 371



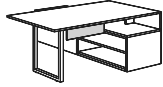
U Base  
Page 371



Rectangular Base ▲  
Page 371

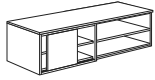
# Vision - Veneer - Overview

## Trim Modesty Panel for Bench Height

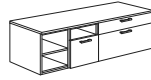


Trim Modesty Panel  
Page 371

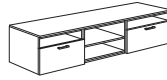
## Freestanding Bench Height Configurations



72" and 60" Bench Height Configurations  
Pages 372-373

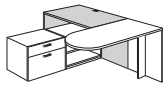


72" Bench Height Configurations  
Page 374

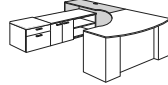


90" Bench Height Configurations  
Page 375

## Shell Return for Bench Height

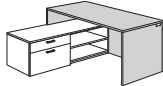


Bench Height Supported Shell Return  
Page 376

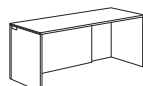


Bench Height Supported Cockpit Shell Return  
Page 376

## Shell Credenzas for Bench Height



Bench Height Shell Credenza  
Page 376



Shell Credenza  
Page 376

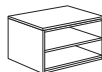
## Freestanding Bench Height Cabinets



Box/File  
Page 377



Box/File  
Page 377



Open Shelf  
Page 378



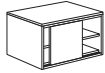
Open Shelf  
Page 378



Open Shelf/File Drawer  
Page 378



Open Shelf/File Drawer  
Page 378



Sliding Door  
Page 378



Hinged Doors  
Page 379



Hinged Door  
Page 379

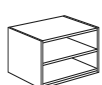
## Modular Bench Height Cabinets



Box/File  
Page 380



Box/File  
Page 380



Open Shelf  
Page 380



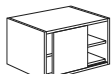
Open Shelf  
Page 380



Open Shelf/File Drawer  
Page 380



Open Shelf/File Drawer  
Page 381



Sliding Door  
Page 381



Hinged Doors  
Page 381



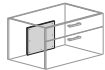
Hinged Door  
Page 381

# Vision - Veneer - Overview

## Top for Modular Bench Height Cabinets



Modular Bench Height Tops  
Page 382



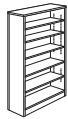
Counterweight  
Page 383

## Bench Height Seat Cushions

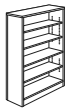


Bench Height Seat Cushions  
Pages 384-385

## Bookcases



Bookcase  
Page 386



Bookcase  
Page 386



Bookcase  
Page 386



Bookcase  
Page 386



Bookcase  
Page 386



Bookcase with  
Bottom Doors  
Page 387



Bookcase with  
Bottom Doors  
Page 387

## Lateral Files



Lateral File  
Page 388



Lateral File  
Page 388



Lateral File  
Page 388

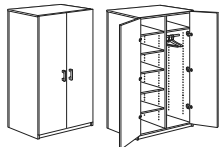


Box/Box/File  
Mobile Pedestal  
Page 389

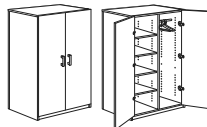


Mobile Lateral File  
w/Cushion Top  
Page 389

## Wardrobes



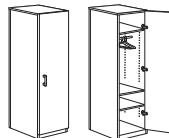
84" h Wardrobe  
Page 390



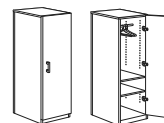
72" h Wardrobe  
Page 390



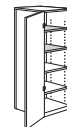
Hanging Bar to Shelves  
Conversion Kit  
Page 390



84" h Wardrobe  
Page 391

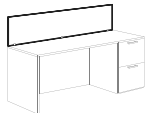


72" h Wardrobe  
Page 391

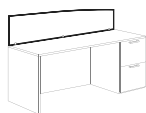


Hanging Bar to Shelves  
Conversion Kit  
Page 391

## Privacy screen



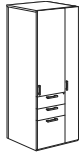
Rectangle Privacy Screen  
Page 404



Fin Privacy Screen  
Page 404

# Vision - Veneer - Overview

## Storage Cabinets



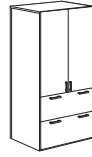
84" h Box/Box/File Storage Wardrobe  
Page 392



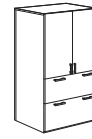
72" h Box/Box/File Storage Wardrobe  
Page 392



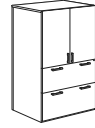
57" h Box/Box/File Storage Wardrobe  
Page 392



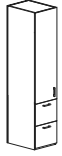
84" h File/File Lateral Storage Cabinet  
Page 393



72" h File/File Lateral Storage Cabinet  
Page 393



57" h File/File Lateral Storage Cabinet  
Page 393



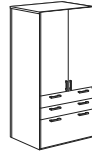
84" h File/File Storage Cabinet  
Page 394



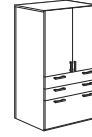
72" h File/File Storage Cabinet  
Page 394



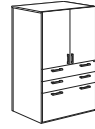
57" h File/File Storage Cabinet  
Page 394



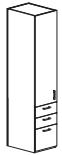
84" h Box/Box/Lateral File Storage Cabinet  
Page 396



72" h Box/Box/Lateral Storage Cabinet  
Page 396



57" h Box/Box/Lateral Storage Cabinet  
Page 396



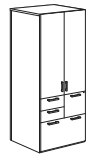
84" h Box/Box/File Storage Cabinet  
Page 395



72" h Box/Box/File Storage Cabinet  
Page 395



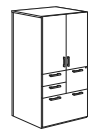
57" h Box/Box/File Storage Cabinet  
Page 395



84" h Multi-File Storage Cabinet  
Page 397



72" h Multi-File Storage Cabinet  
Page 397



57" h Multi-File Storage Cabinet  
Page 397



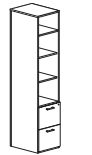
84" h Storage Cabinet  
Page 398



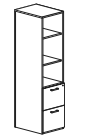
72" h Storage Cabinet  
Page 398



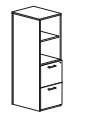
57" h Storage Cabinet  
Page 398



84" h Open Top, File/File Storage Cabinet  
Page 399



72" h Open Top, File/File Storage Cabinet  
Page 399



57" h Open Top, File/File Storage Cabinet  
Page 399



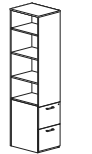
84" h Open Top, Box/Box/File Storage Cabinet  
Page 400



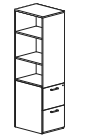
72" h Open Top, Box/Box/File Storage Cabinet  
Page 400



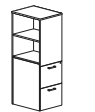
57" h Open Top, Box/Box/File Storage Cabinet  
Page 400



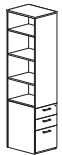
84" h File/File Storage Cabinet w/Side Access  
Page 401



72" h File/File Storage Cabinet w/Side Access  
Page 401



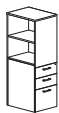
57" h File/File Storage Cabinet w/Side Access  
Page 401



84" h Box/Box/File Storage Cabinet w/Side Access  
Page 402

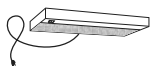


72" h Box/Box/File Storage Cabinet w/Side Access  
Page 402

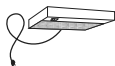


57" h Box/Box/File Storage Cabinet w/Side Access  
Page 402

## Task Lights



48" w Task Light  
Page 412



24" w Task Light  
Page 412



31" w LED Starter Task Light  
Page 412



31" w LED Linking Adder Task Light  
Page 412



17" w LED Starter Task Light  
Page 413



17" w LED Linking Adder Task Light  
Page 413

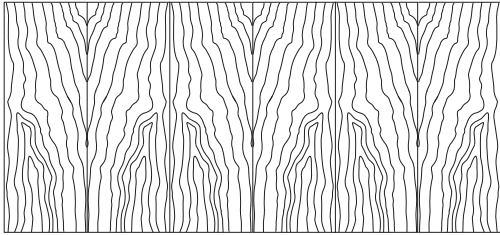


Motion Sensor for Task Lights  
Page 413

## Vision Veneer Product Information

### Exterior Wood Materials

Exterior surfaces are made from the finest selected veneers to achieve clarity and consistency in the Vision Veneer product line. To attain a pleasing, symmetrical pattern, all cherry, maple, walnut veneers in Vision Veneer are book-matched. All exterior solid lumber is matched to coordinate with the veneer.

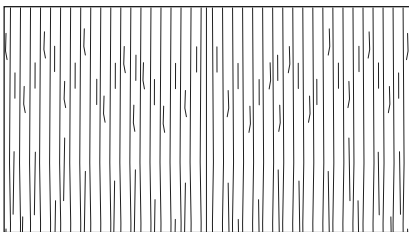


#### Book-Matched Example

Alternating pieces of veneer are flipped over so they face each other like the pages within a book

Vision Veneer is available in flat cut cherry, maple and walnut veneer. A wide range of wood stains have been formulated to enhance the beauty of the veneer.

Double Cut veneer is another choice on Vision Veneer product. This veneer is a processed product that has at least two cuttings to create the final veneers. These cuts of veneer strands are dyed and layered into a block to create variation of patterns from a very tight grain pattern to an exotic figure grain pattern. The diagram below show the tight pattern used on Vision Veneer.



Cherry veneer is the only veneer species available on the  quickship program on select models.

### Work Surface Construction

Tops are 5-ply balanced construction, 1 3/16" thick with solid matching hardwood edges. Surfaces are available in wood veneer or high pressure laminate. No additional charge for using our coordinating high pressure laminate with a veneer grain pattern with finish wood edges.

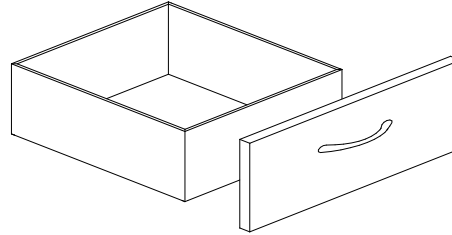
### Case Construction

Outside panels are 1 3/16" ▲ and joined together with dowels reinforced with screws, cleats and metal fasteners for increased stability. Leveling glides are set into solid hardwood blocks, which helps to prevent the leveling glide from tear out. Tops are secured to the chassis with top fastening cleats screwed to the inside of the panels.

Cabinet doors have 110° swing hinges to allow adequate access into the interior of the cabinet.

### Drawers

The unidirectional V- Fold drawer box is a durable miter-fold drawer structure which is glued and doweled. The 1/2" thick drawer sides are wrapped in a high grade maple vinyl, with an attached front. The drawer front is attached to the four sided box.



Optional four corner dovetailed wood drawers are available. Specify and add 10% per unit.

### Drawer Suspension

High quality black drawer suspension carries a lifetime warranty. File and box drawers have 100% full extension with over travel. Slides feature steel ball bearings for longer wear and positive, cushioned in/out stops.

### Filing Hardware

All file drawers are constructed with a custom designed for hanging folders. Filing diagram on pages 238-243.

### Locking

All desks, credenzas, returns and mobile pedestals feature pedestal front locking to provide maximum security and flexibility in configuration.

Units are shipped randomly keyed as standard. Key alike units are available upon request for no additional charges. Removable cores for in-field re-keying are standard.

# Vision Veneer Product Information

## Finish - Stain/Colors

We offer a variety of wood stains on Vision Veneer. Please see the chart below. Samples are available upon request. Former finish names are listed in parentheses for reference.

### CH1 Cherry *Flat Cut Veneer*

AUT Autumn ( <i>Autumn Cherry</i> )	EAR Earthy
BRL Barley	LGC Legacy ( <i>Legacy Cherry</i> )
BBN Bourbon ( <i>Natural Cherry</i> )	PRL Praline ( <i>Vintage Cherry</i> )
BRG Brighton ( <i>Brighton Cherry</i> )	SAF Saffron ( <i>Medium Cherry</i> )
CLA Classic ( <i>Classic Cherry</i> )	

### MA1 Maple *Flat Cut Veneer*

ALE Ale ( <i>Natural Maple</i> )	FLX Flax
BUT Butterscotch	VEN Venetian ( <i>Dark Mahogany</i> )
CIN Cinnamon	

### WA1 Walnut *Flat Cut Veneer*

AUB Auburn ( <i>Windsor Mahogany</i> )	SIE Sienna
ESP Espresso	TOF Toffee
MCH Mocha	TRF Truffle
NTO Night Owl ( <i>Vintage Walnut</i> )	

### DC1 Double Cut Veneer *Eased Edge Only*

COF Coffee	KHK Khaki
CRM Cremello	STU Studio Teak
GRH Graphite	

## Protective Top Coat

DuraTex™ offers exceptional hardness along with abrasion and impact resistance, it has been formulated to eliminate hazardous and harmful gases that are normally associated with wood finish.

## DuraTex™ Features

- Safety** - Significantly reduces hazardous formaldehyde emissions which help improve the quality of the of the indoor air we breathe.
- Quality** - Developed to be tough and durable with special attention to appearance. The DuraTex™ finish preserves the natural beauty of wood.
- Durability** - Designed to meet a wide range of demanding performance and environmental standards to withstand even the highest wear and tear.

## Special Finishes

Special finishes can be requested by following the instruction in the general introduction section, page 3. There is a one time charge of \$289 list per order.

## Product Modification

### Laminate Tops

Work surface only, no additional upcharge if Vision's coordinating wood grain laminate is specified. Contact Customer Service for any other laminate request. Listed below are finishes that have coordinating wood grain HPL laminates.

Cherry Finishes	Maple Finishes	Walnut Finishes
-----------------	----------------	-----------------

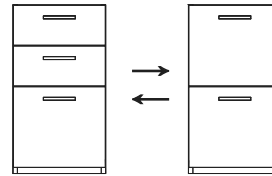
Autumn	Ale	Auburn
Barley	Cinnamon	Mocha
Bourbon	Venetian	Night Owl
Brighton		Sienna
Classic		Toffee
Legacy		Truffle
Praline		
Saffron		

### Oak Veneer

Upon request veneer can be changed from the standard offering to oak plain sliced veneer with a 40% upcharge on to the list of each item.

### Pedestal Configuration Change

Desks have one box/box/file pedestal. The pedestal double pedestal has a file/file on right side. Returns and credenzas are configured with file/file pedestals.



Drawer configurations can be changed from either a box/box/file or a file/file configuration, on unit 30" high, but must be specified at the time of order. An additional 5% upcharge needs to be added to the list price of the unit. (*Must keep the same pedestal depth.*)

### Wood drawers

Four corner dovetailed wood drawers must be specified at the time of order placement. There is a 10% upcharge added to the list of each item.

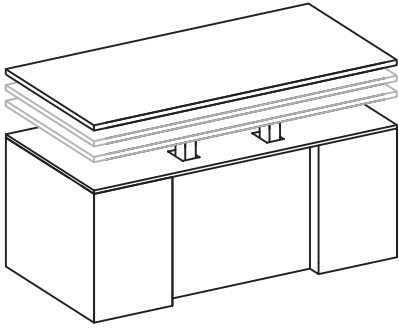
### Finish Sheen Modification

Finish sheen can be modified on the work surface tops. There is a 15% upcharge added to the list of each item.

### Special Construction

Vision Veneer offers large offering to create many types of configuration. Contact Customer Service if you are having trouble with finding the right units to complete the desired configuration. Requests need to be approved by JSI engineering.

## Vision Veneer Product Information



This mechanism requires a signed Liability Waiver prior to time of order specification.

Contact Customer Service or visit our Website at [jsifurniture.com](http://jsifurniture.com)

### ERGO Adjustable Work Height Mechanism

Our proprietary adjustable work height mechanism can be specified on many of the models in Vision Veneer.

ERGO mechanism allows height adjustability to be added to the worksurface. Our solution uses a standardized design that minimizes the modifications required to standard desk, bridge, or credenza models. The mechanism and control box are neatly concealed to maintain the appearance of the original elegance of the product. A push button activates the electric powered lifting columns for adjustability from sitting height to a standing height. A 3/4" thick finished sub top is added to the top of the desk chassis for a clean appearance when the surface is in the raised position. In the lowered position, please note that ERGO adds 3/4" to the standard height of the desk and the installation will decrease knee space depth by 8".

Automatic Collision Control is built in to each mechanism as a standard feature. When the system senses an obstacle obstructing the movement, the mechanism will reverse direction and retreat by 1".

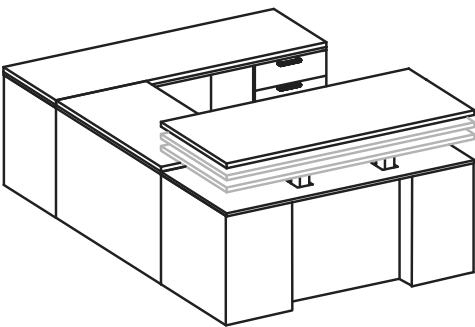
When ERGO is added to a worksurface in an "L" or "U" group, all units in the configuration need to have a sub top added. These units are considered to be ERGO ADJACENT units. ERGO ADJACENT units must have a fixed height worksurface that matches the lowest position of the ERGO mechanism and the top. This is accomplished by adding a 3/4" sub top between the chassis and the worksurface. This feature can also be specified for cabinets which may sit next to a unit with the ERGO mechanism.

Height adjustment starts at 30 3/4", to a standing height of 49 3/4", a range of 19 1/2".

To specify the unit that has the mechanism, add **ERGO** to the end of the model number.

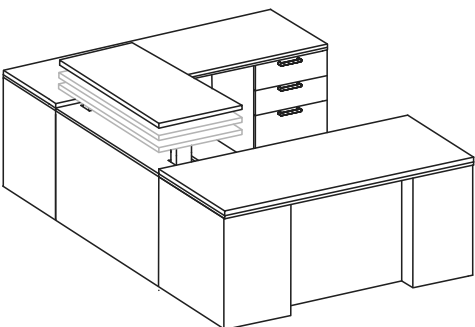
To specify the connecting or adjacent units add, **ERGO ADJACENT** to the end of the model number.

The Ergo mechanism and controls are warranted for a period of (1) year. The rest of the case/good unit(s) are warranted under the normal fifteen (15) year warranty. ▲



#### Example

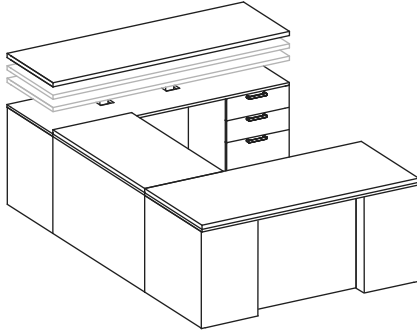
VV3672LD-ERGO	add \$3,255 to list
VV2448EB-ERGO ADJACENT	add \$447 to list
VV2472RC-ERGO ADJACENT	add \$525 to list



#### Example

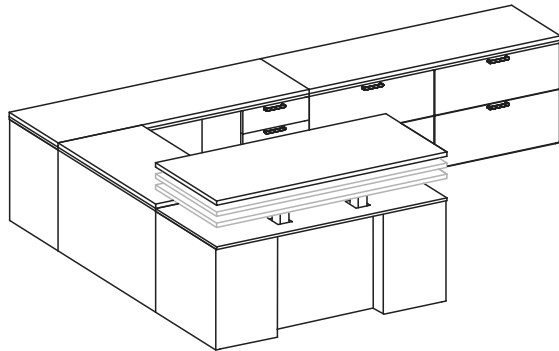
VV3672LD-ERGO ADJACENT	add \$525 to list
VV2448EB-ERGO	add \$3,255 to list
VV2472RC-ERGO ADJACENT	add \$447 to list

## Vision Veneer Product Information



*Example*

VV3672LD-ERGO ADJACENT	add \$525 to list
VV2448EB-ERGO ADJACENT	add \$447 to list
VV2472RC-ERGO	add \$3,255 to list



*Example*

VV3672LD-ERGO	add \$3,255 to list
VV2448EB-ERGO ADJACENT	add \$447 to list
VV2472RC-ERGO ADJACENT	add \$525 to list
VV2472LFC-ERGO ADJACENT	add \$525 to list

### Availability of Vision Veneer Units with the Mechanism

The following models are available with the ERGO Adjustable Work Height Mechanism. When specifying, add "ERGO" to the end of the model number.

Double Pedestal Desk	Single Pedestal Desk	Bridges	Credenzas	Returns
Add \$3,255 to the list price.	Add \$3,255 the list price. These units require adjacent products to create "L" and "U" layouts	Add \$3,255 to the list price. These units require adjacent products to create "L" and "U" layouts	Add \$3,255 to the list price. These units require adjacent products to create "L" and "U" layouts	Add \$3,255 to the list price. These units require adjacent products to create "L" and "U" layouts
VV3672BD*	VV3672LBD	VV2448EB	VV2472KC*	VV2448ELCR
VV3672DD*	VV3672RBD	VV2442EB	VV2466KC*	VV2448ERCR
VV3072DD*	VV3672LD		VV2460KC*	VV2448ELR
VV3066DD*	VV3672RD		VV2472LC	VV2448ERR
VV3060DD*	VV3072LD		VV2472RC	VV2442ELCR
	VV3072RD		VV2460LC	VV2442ERCR
	VV3066RD		VV2460RC	VV2442ELR
	VV3066LD		VV2466LC	VV2442ERR
	VV4872CBDL		VV2466RC	
	VV4872CBDR			
	VV4272CLD			
	VV4272CRD			

\* indicates freestanding unit and does not require adjacent products

\* indicates freestanding unit and does not require adjacent products

### Connecting or Adjacent Units to Match Starting Height

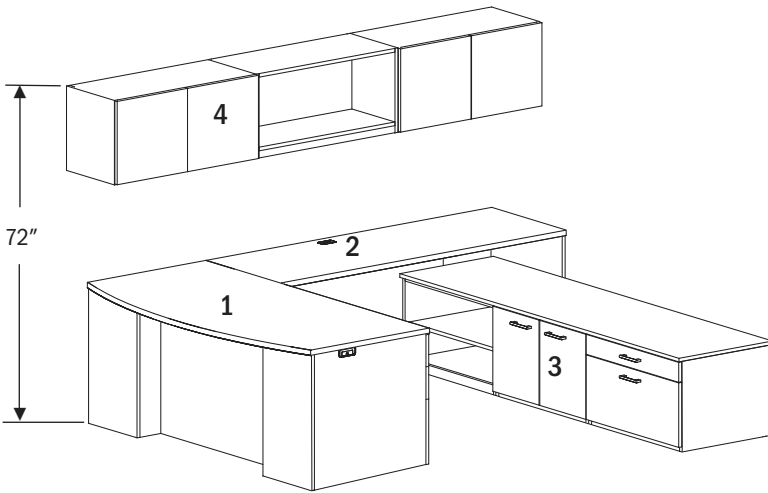
All the units listed above can be specified as connecting or adjacent units. Other Vision Veneer units could also be used as connecting units. Please contact Customer Service for additional items and pricing. When specifying, please add "ERGO ADJACENT" to the end of the model number.

Pricing for Standard Connecting or Adjacent Units  
 Tops larger than 24" x 48" add \$525 to the list price.  
 Tops 24" x 48" or smaller add \$447 to the list price.

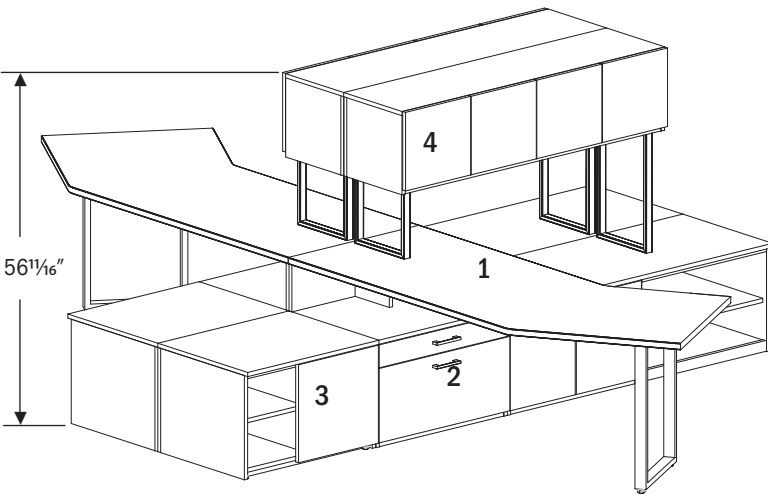


# Vision Veneer Product Information

## Layouts



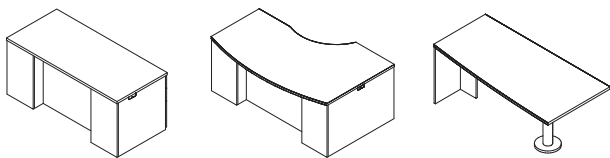
Vision Veneer can be configured in many different ways to achieve the perfect layout.



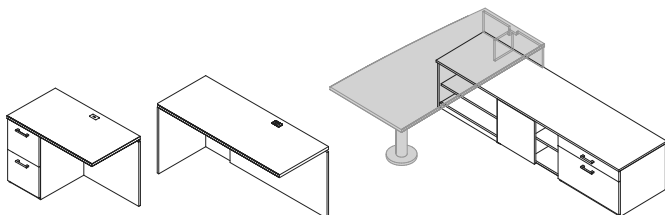
Create open plan or teaming stations with Vision Veneer modular components.

## Easily Specified Layout

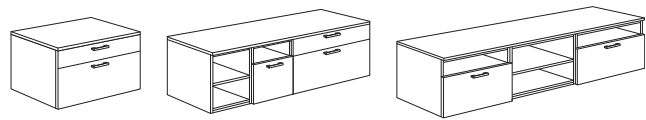
**1 Primary Worksurfaces** are available in traditional desks with pedestals or peninsula worksurfaces with a variety of shapes. The pedestal desks have end panel grommets for wire management.



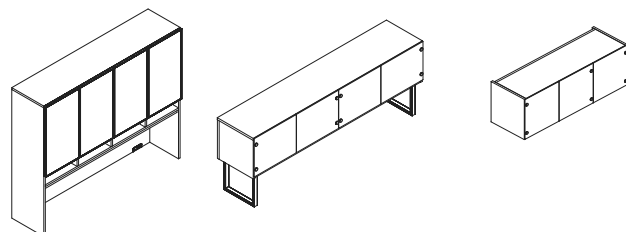
**2 Side Worksurfaces** can be corner shell returns, bench height credenzas, pedestal returns, and adjustable tables. Peninsula desks with bench height support can be specified to work with the bench height credenzas.



**3 Bench Height Credenzas.** Vision Veneer offers a wide range of storage configurations. Modular groups of bench height credenzas can be specified to create unique configurations. Seat cushions are ordered separately from the credenza and allow customers to choose the fabrics.

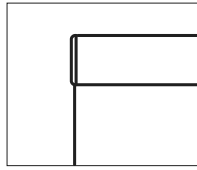


**4 Overhead Storage Cabinets.** Traditional style overheads are available along with post support overheads, which can be used in open plan. Both are available in two heights. Wall mounted overheads can provide a light scale solution.

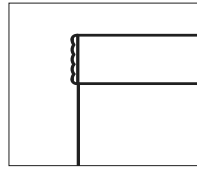


# Vision Veneer Product Information

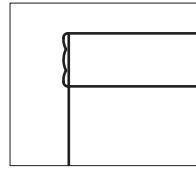
## Top Edge Details



Eased (R3)



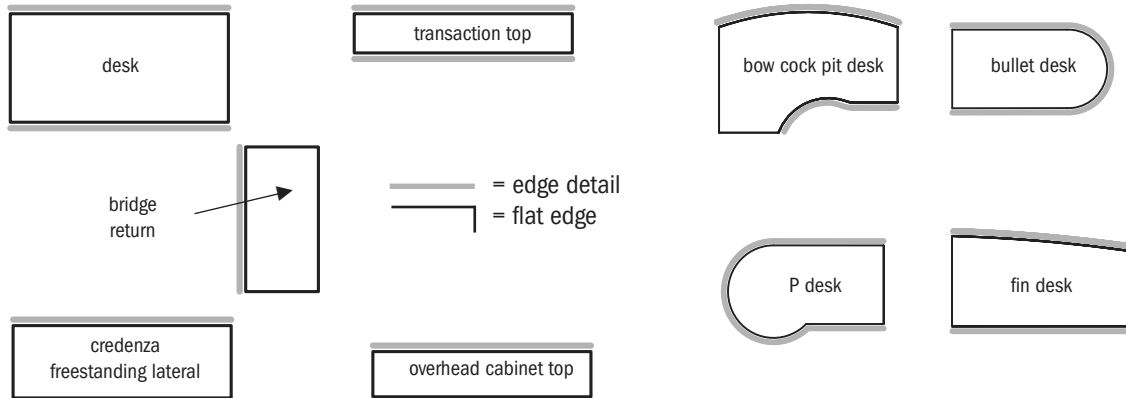
Reeded (H3)



Transitional (C3)

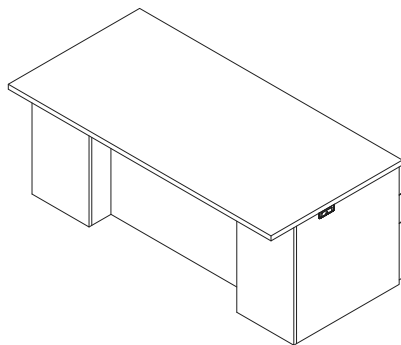
▲ Note: Double Cut Veneer only available in Eased Edge.

## Top Edge Detail Location

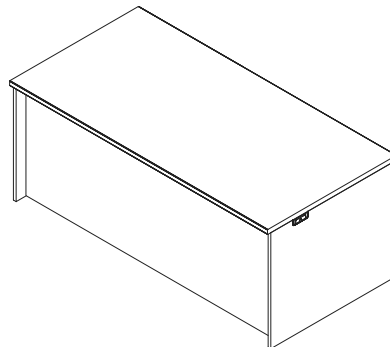


## Approach View of Pedestal Desk

Vision Laminate offers two distinct approach views for desk. Specify a model with either a break front modesty or a recessed modesty. Desk model numbers ending in "F" have the full recessed modesty panel.

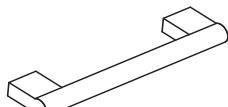


Break Front (model #VL3672DD)



Recessed Front Modesty (model #VL3672DDF)

## Pull Style and Color Options



**Bar**  
Matte Black (MBK)  
Polished Nickel (PNK)



**Fluent**  
Matte Black (MBK)  
Matte Nickel (MNK)



**Healy**  
Matte Nickel (MNK)



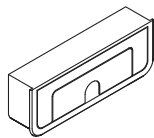
**Reveel**  
Matte Nickel (MNK)



**Sweep**  
Matte Black (MBK)  
Matte Nickel (MNK)

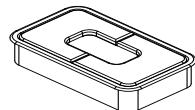
## Vision Veneer Product Information

### Grommet and Color Options



#### End/Back Panel Grommet

The end/back panel grommets are standard on desks, returns, standard height credenzas, and modular cabinets with end panels. This grommet is also on back panels of returns and on back panels for overhead cabinets.



#### Worksurface Grommet

Worksurface grommets are standard on the bridge, return units, and corner units.

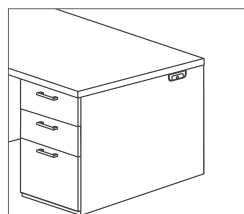
Matte Black (MBK)  
Stardust Silver (STS)

Grommets are available in Matte Black (MBK) or Stardust Silver (STS). Choose one color for all grommets. If no color is selected, grommet color will coordinate with the pull color. Lock cores will match grommet color. Additional grommets can be added. Location must be approved by JSI manufacturing, contact Customer Service.

Add \$79 to the list for each additional grommet.

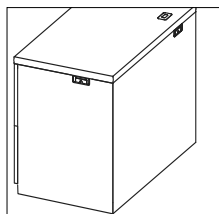
### Standard Grommets Locations

Vision Laminite features grommets for wiring to pass thru the unit.



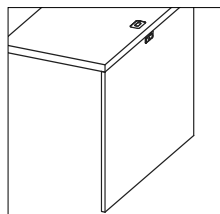
#### Desks - Credenza

End Panel Grommet



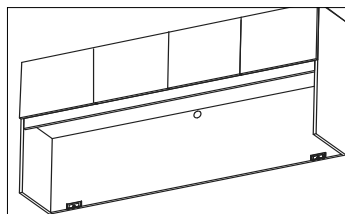
#### Returns

Work Surface Grommet  
End Panel Grommet  
Back Panel Grommet



#### Bridge

Work Surface Grommet  
Back Panel Grommet



#### Overhead Cabinet

Back Panel Grommet  
Back Center Pass Thru

### Wire Management

Wiring can move freely from unit to unit with the standard grommets and out to the building data and power.

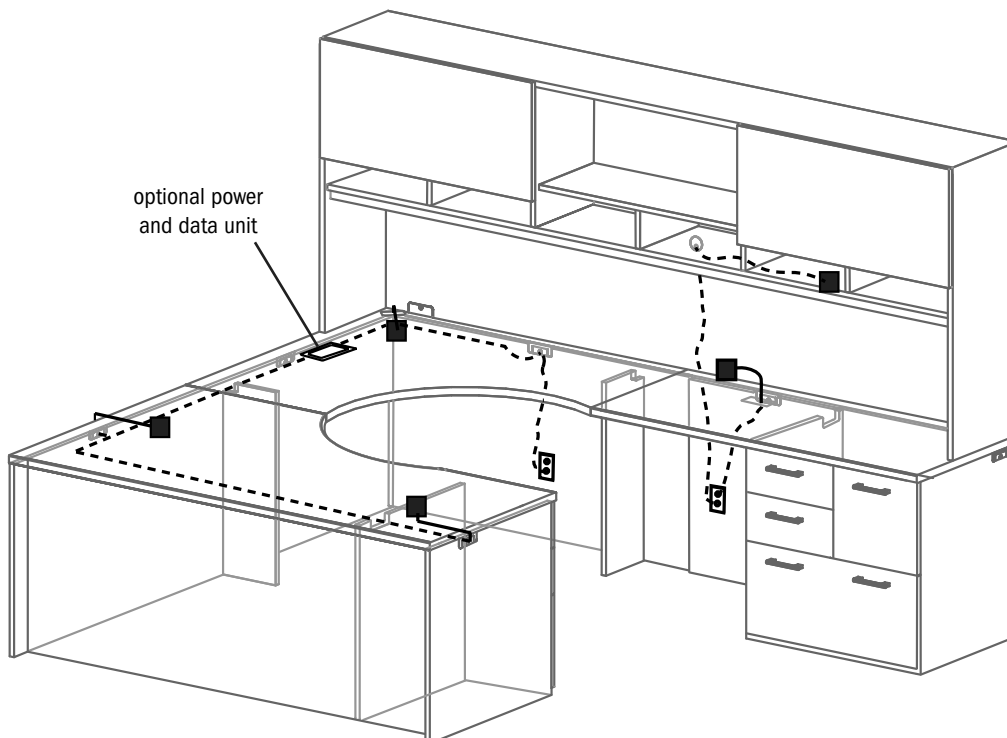
Pedestal desks, credenzas, corners units, bridge panels, return modesty and end panels are standard with end panel grommets.

The end panel grommet opening is 4" wide by 1 7/16" high with a bezel trim secured to the panel with a friction side cap.

Top grommets are standard in returns, bridges and corner units. Additional top grommets may be specified as an option.

Optional power and data units can be positioned in the tops to provide tilt up technology access at the worksurface.

Refer to the accessory section for these items or other accessories items. (see page 407)



# Vision Veneer Product Information

## Peninsula and Modular Top Shapes



**Rectangle**  
peninsula/modular



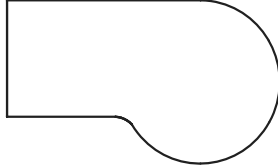
**Bullet**  
peninsula/modular



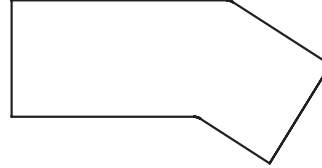
**Extended Corner**  
modular



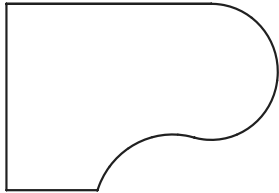
**Fin**  
peninsula



**"P" Top**  
peninsula



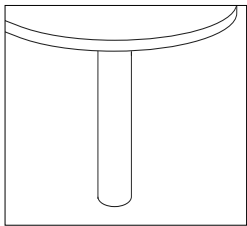
**Boomerang**  
modular



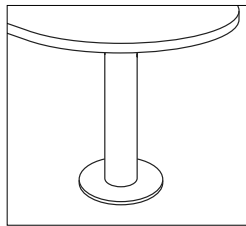
**Extended Corner Bullet**  
peninsula/modular

## Base for Worksurface Tops and Finish Colors Options

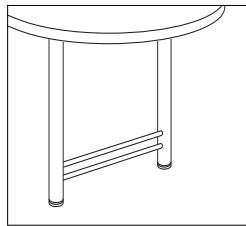
These base styles can be used with Bullet, Cockpit Bullet, Fin, P-Top or Rectangle Peninsula Desk. These base styles can also be used with Modular and Bullet Return Tops.



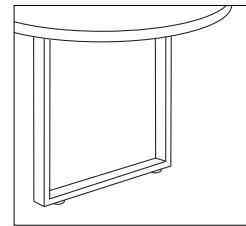
**Column Base**  
Black Sandtex (BSX)  
Stardust Silver (STS)



**Column Disk Base**  
Black Sandtex (BSX)  
Stardust Silver (STS)

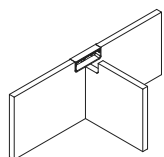


**H Base**  
Black Sandtex (BSX)  
Stardust Silver (STS)

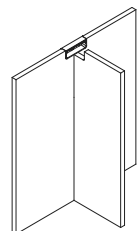


**U Base**  
Black Sandtex (BSX)  
Stardust Silver (STS)

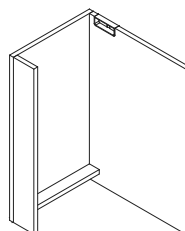
## Modular Top End Supports for Peninsula and Modular Tops



**Bench Height "T" Support**  
use with bench height credenza



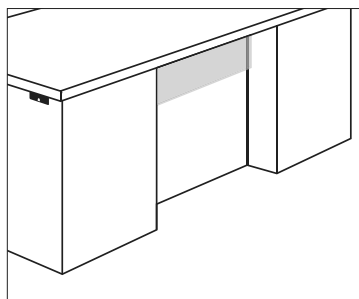
**Full Height "T" Support**  
use with peninsula or modular tops



**Wing End Support**  
use to create a modular open corner credenza

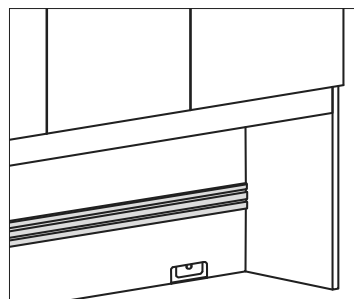
## Vision Veneer Product Information

### Product Features and Options



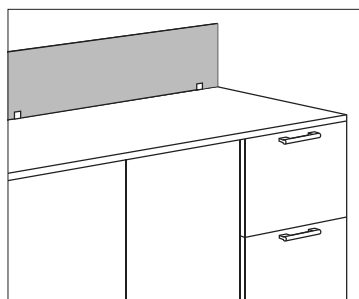
#### Trim Modesty Panels

- Mounts in front of existing modesty panel
- Mounts to the underside of the top
- Acrylic Panel - Frosted
- Stainless Steel Puck Style attachment
- Field installed



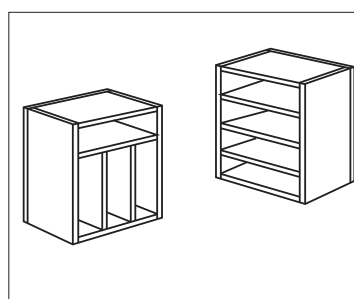
#### Aluminum Accessory Rail

- Anodized Aluminum finish
- Accessory Tools (see page 319)
  - Upright Tray
  - Small Tray
  - Pencil Tray
  - Paper Tray
  - File Hanger



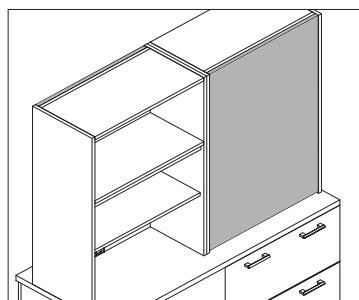
#### Privacy Screens

- Mounts to the edge of the work surface
- Acrylic Panel - Frosted
- Attachment hardware is included
- Field installed



#### Paper Sorters

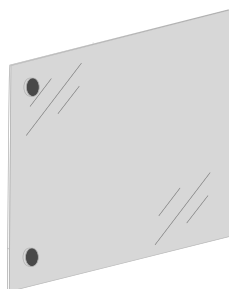
- Can provide support for transaction work surfaces
- Use under overhead cabinet storage
- Field configured - horizontal shelf and vertical shelves or all horizontal shelves



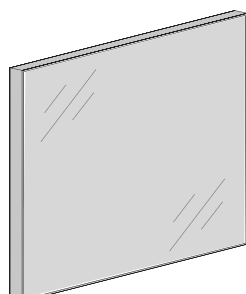
#### Fabric Back Panel

- excellent solution for open plan or room dividers
- tackable surface
- standard with Culp Montgomery Sterling panel fabric
- COM or JSI fabric program available
- mounts with covered buttons

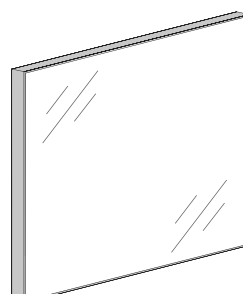
### Glass Door Options for Overhead Cabinets, Storage Towers, and Wall Mounted Cabinets



**Frosted**  
Frameless  
(Frosted glass with acid etched back)



**Frosted**  
Aluminum Frame  
(Frosted glass with acid etched back)



**White Back Painted**  
Aluminum Frame  
(Glossy low iron white back painted glass)

# Vision Veneer Product Information

## Finish and Reference Codes - Summary

<b>Select</b>	<b>Code</b>
<b>Veneer/Substrate</b>	
Cherry	CH1
Maple	MA1
Walnut	WA1
Double Cut	DC1
<b>Finish</b>	
<b>Cherry Finishes</b>	
Autumn	AUT
Barley	BRL
Bourbon	BBN
Brighton	BRG
Classic	CLA
Earthy	EAR
Legacy	LGC
Praline	PRL
Saffron	SAF
<b>Maples Finishes</b>	
Ale	ALE
Butterscotch	BUT
Cinnamon	CIN
Flax	FLX
Venetian	VEN
<b>Walnut Finishes</b>	
Auburn	AUB
Espresso	ESP
Mocha	MCH
Night Owl	NTO
Sienna	SIE
Toffee	TOF
Truffle	TRF
<b>Double Cut Finishes</b>	
Coffee	COF
Cremello	CRM
Graphite	GRH
Khaki	KHK
Studio Teak	STU
<b>Metal Colors</b>	
Matte Black	MBK
Stardust Silver	STS

<b>Drawer Pulls</b>	<b>Code</b>
Bar - Matte Black	MBK
Bar - Polished Nickel	PNK
Fluent - Matte Black	MBK
Fluent - Matte Nickel	MNK
Reveal - Matte Nickel	MNK
Healy - Matte Nickel	MNK
Sweep - Matte Black	MBK
Sweep - Matte Nickel	MNK

<b>Grommets</b>	
End and Surface - Matte Black	MBK
End and Surface - Stardust Silver	STS

<b>Peninsula Supports</b>	
Column Base - Black Sandtex	BSX
Column Base - Stardust Silver	STS
Column Disc Base - Black Sandtex	BSX
Column Disc Base - Stardust Silver	STS
H Base - Black Sandtex	BSX
H Base - Stardust Silver	STS
U Base - Black Sandtex	BSX
U Base - Stardust Silver	STS

<b>Overhead Cabinet Doors - Glass Options</b>	
White Back Painted - Aluminum Frame	GD004
Frosted - Aluminum Frame	GD002
Frosted - Frameless	GD001

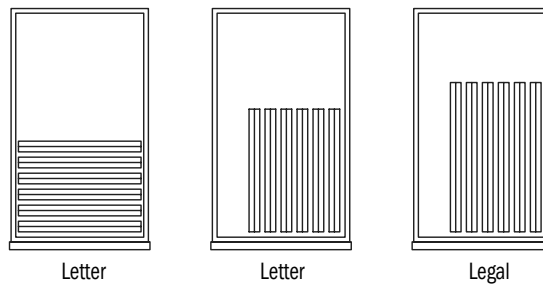
<b>Drawer Box</b>	
Vinyl Wrapped Maple Pattern <i>standard</i>	DRM001
Birch Plywood	DRM002 <i>see page 228 price add-on</i>

## Vision Veneer Product Information

### DESK

Model	Description	Drawer Configuration (User Side)	
		Left Pedestal	Right Pedestal
WV3672BD	Double Pedestal Bow Desk	Box/Box/File	File/File
WV3672DD	Double Pedestal Desk	Box/Box/File	File/File
WV3072DD	Double Pedestal Desk	Box/Box/File	File/File
WV3066DD	Double Pedestal Desk	Box/Box/File	File/File
WV3060DD	Double Pedestal Desk	Box/Box/File	File/File
WV4872CBDR	Right Pedestal Bow Cockpit Desk		Box/Box/File
WV4872CDDL	Left Pedestal Bow Cockpit Desk	Box/Box/File	
WV4272CRD	Right Pedestal Cockpit Desk		Box/Box/File
WV4272CLD	Left Pedestal Cockpit Desk	Box/Box/File	
WV3672RBD	Right Pedestal Bow Desk		Box/Box/File
WV3672LBD	Left Pedestal Bow Desk	Box/Box/File	
WV3672RD	Right Pedestal Desk		Box/Box/File
WV3672LD	Left Pedestal Desk	Box/Box/File	
WV3066RD	Right Pedestal Desk		Box/Box/File
WV3066LD	Left Pedestal Desk	Box/Box/File	

### Filing Options (Diagram 1)

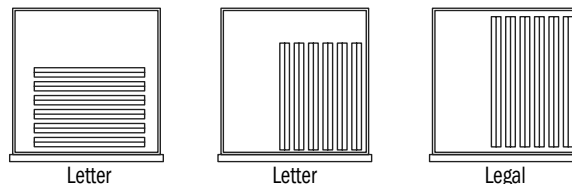


Interior Drawer Dimensions	Depth	Width	Height
Box	21"	12"	3 1/4"
File	21"	12"	9 1/8"

### MOBILE PEDESTALS

Model	Description	Drawer Configuration
		Single Pedestal Width
WV1620MP	Mobile Pedestal	Box/Box/File

### Filing Options (Diagram 2)

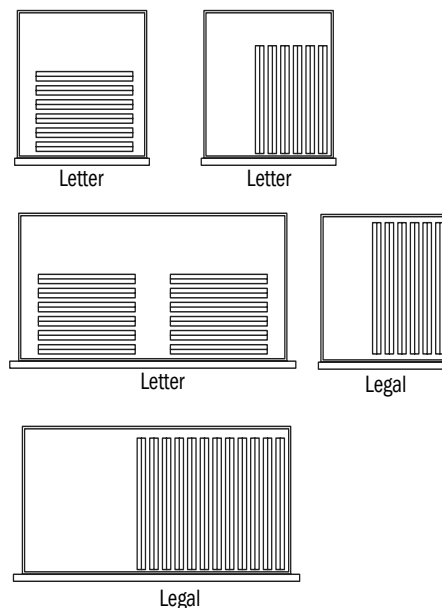


Interior Drawer Dimensions	Depth	Width	Height
Box	15"	12"	3 1/4"
File	15"	12"	9 1/8"

### EXECUTIVE RETURNS

Model	Description	Drawer Configuration (User Side)	
		Left Pedestal	Right Pedestal
WV2448MLR	Right Multi-File Return		2 Box/File/Lateral File
WV2448MLL	Left Multi-File Return	2 Box/File/Lateral File	
WV2448MRCR	Rt. Multi-File Corner Return		2 Box/File/Lateral File
WV2448MLCR	Lt. Multi-File Corner Return	2 Box/File/Lateral File	

### Filing Options (Diagram 3)



Interior Drawer Dimensions	Depth	Width	Height
Box	15"	12"	3 1/4"
File	15"	12"	9 1/8"
Lateral File	15"	26 5/16"	9 1/8"

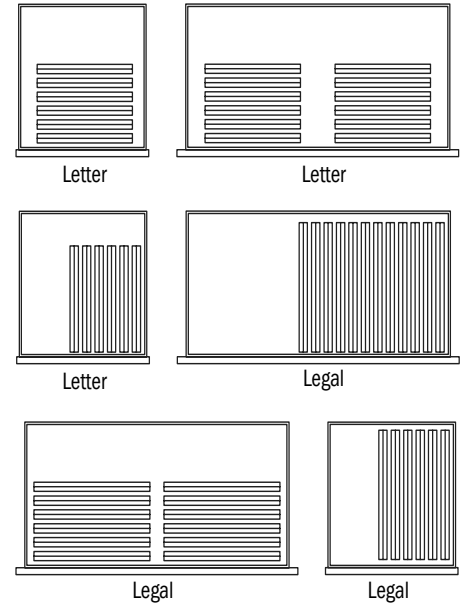
# Vision Veneer Product Information

## EXECUTIVE RETURNS

Model	Description	Drawer Configuration (User Side)	
		Left Pedestal	Right Pedestal
W2448ERR	Right Executive Return		File/File
W2448ELR	Left Executive Return	File/File	
W2448ERCR	Right Corner Return		File/File
W2448ELCR	Left Corner Return	File/File	
W2442ERR	Right Executive Return		File/File
W2442ELR	Left Executive Return	File/File	
W2442ERCR	Right Corner Return		File/File
W2442ELCR	Left Corner Return	File/File	
W2448LRR	Right Lateral Return		Lat. File/Lat. File
W2448LLR	Left Lateral Return	Lat. File/Lat. File	
W2448LRCR	Right Lateral Corner Return		Lat. File/Lat. File
W2448LLCR	Left Lateral Corner Return	Lat. File/Lat. File	

Interior Drawer Dimensions	Depth	Width	Height
Box	15"	12"	3 1/4"
File	15"	12"	9 1/8"
Lateral File	15"	32 5/16"	9 1/8"

### Filing Options (Diagram 4)

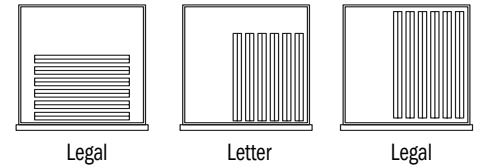


## CREDENZA

Model	Description	Drawer Configuration (User Side)	
		Left Pedestal	Right Pedestal
W2472SC	Storage Credenza <sup>1</sup>	File/File	File/File
W2466SC	Storage Credenza <sup>1</sup>	File/File	File/File
W2472KC	Kneespace Credenza	File/File	File/File
W2466KC	Kneespace Credenza	File/File	File/File
W2460KC	Kneespace Credenza	File/File	File/File

Interior Drawer Dimensions	Depth	Width	Height
File	15"	12"	9 1/8"

### Filing Options (Diagram 2)



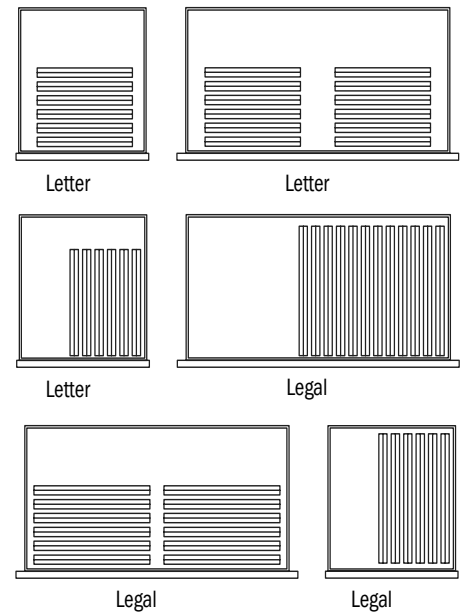
<sup>1</sup>Center Section - Hinge Door Storage

## CREDENZA

Model	Description	Drawer Configuration (User Side)	
		Left Pedestal	Right Pedestal
W2472RC	Right Pedestal Credenza		File/File
W2472LC	Left Pedestal Credenza	File/File	
W2466RC	Right Pedestal Credenza		File/File
W2466LC	Left Pedestal Credenza	File/File	
W2460RC	Right Pedestal Credenza		File/File
W2460LC	Left Pedestal Credenza	File/File	
W2472LRC	Right Lateral File Credenza		Lat. File/Lat. File
W2472LLC	Left Lateral File Credenza	Lat. File/Lat. File	

Interior Drawer Dimensions	Depth	Width	Height
File	15"	12"	9 1/8"
Lateral File	15"	32 5/16"	9 1/8"

### Filing Options (Diagram 4)





## Vision Veneer Product Information

### Buffet Credenza

Model	Description	Drawer Configuration
W2472BSC	Buffet Credenza <sup>2</sup>	Along the Top <sup>2</sup> 4 Box Drawers
W2436BSC	Buffet Credenza <sup>2</sup>	2 Box Drawers

Interior Drawer Dimensions	Depth	Width	Height
Box	15"	14 3/4"	3 1/4"

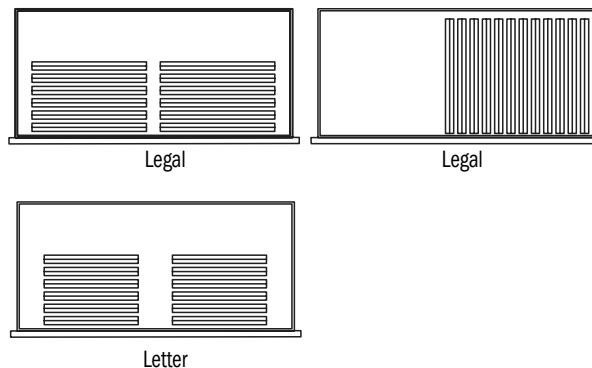
<sup>2</sup>Bottom Section - Hinge Door Storage

### LATERAL FILE CABINET

Model	Description	Drawer Configuration
W2036-57LF	4 Drawer Lateral File Cabinet	Single Lateral Pedestal Width 4 Lateral Drawers
W2036-42LF	3 Drawer Lateral File Cabinet	3 Lateral Drawers
W2036-30LF	2 Drawer Lateral File Cabinet	2 Lateral Drawers
W2436-57LF	4 Drawer Lateral File Cabinet	4 Lateral Drawers
W2436-42LF	3 Drawer Lateral File Cabinet	3 Lateral Drawers
W2436-30LF	2 Drawer Lateral File Cabinet	2 Lateral Drawers

Interior Drawer Dimensions	Depth	Width	Height
Lateral File	15"	32 5/16"	9 1/8"

Filing Options (Diagram 5)

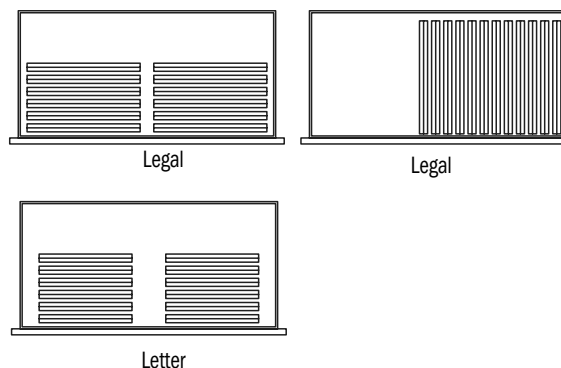


### LATERAL FILE CABINET

Model	Description	Drawer Configuration
W2030-57LF	4 Drawer Lateral File Cabinet	Single Lateral Pedestal Width 4 Lateral Drawers
W2030-42LF	3 Drawer Lateral File Cabinet	3 Lateral Drawers
W2030-30LF	2 Drawer Lateral File Cabinet	2 Lateral Drawers
W2430-57LF	4 Drawer Lateral File Cabinet	4 Lateral Drawers
W2430-42LF	3 Drawer Lateral File Cabinet	3 Lateral Drawers
W2430-30LF	2 Drawer Lateral File Cabinet	2 Lateral Drawers

Interior Drawer Dimensions	Depth	Width	Height
Lateral File	15"	26 5/16"	9 1/8"

Filing Options (Diagram 6)

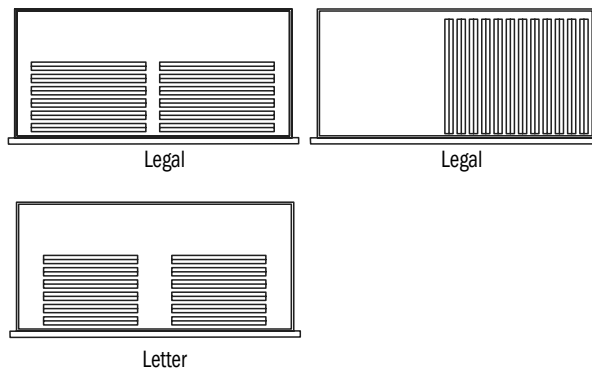


### Tall Storage Cabinets

Model	Description	Drawer Configuration
W2436-57BBFT	Storage Cabinet	Single Lateral Pedestal Width Box/Box/Lateral File
W2436-57FFT	Storage Cabinet	Lateral File/Lateral File

Interior Drawer Dimensions	Depth	Width	Height
Box	15"	32 5/16"	3 1/4"
Lateral File	15"	32 5/16"	9 1/8"

Filing Options (Diagram 5)



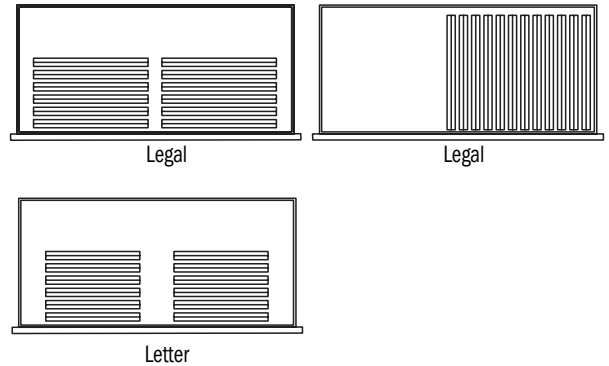
# Vision Veneer Product Information

## Tall Storage Cabinets

Model	Description	Drawer Configuration
VV2430-57BBFT	Storage Cabinet	Single Lateral Pedestal Width Box/Box/Lateral File
VV2430-57FFT	Storage Cabinet	Lateral File/Lateral File

Interior Drawer Dimensions	Depth	Width	Height
Box	15"	26 5/16"	3 1/4"
Lateral File	15"	26 5/16"	9 1/8"

Filing Options (Diagram 6)

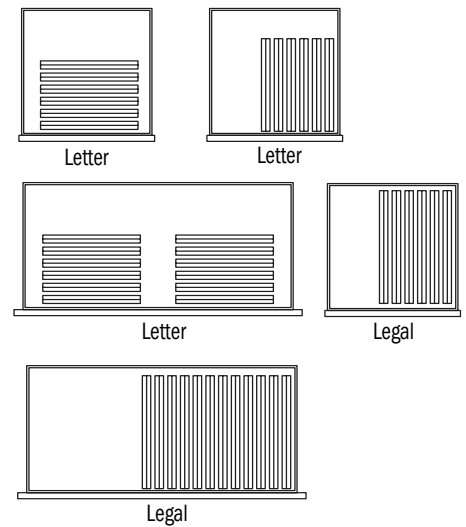


## Tall Storage Cabinets

Model	Description	Drawer Configuration
VV2430-57MFR	Storage Cabinet	Single Pedestal Width (Right) Box/Box-File/Lat. File
VV2430-57MFL	Storage Cabinet	(Left) Box/Box-File/Lat. File

Interior Drawer Dimensions	Depth	Width	Height
Box	15"	12"	3 1/4"
File	15"	12"	9 1/8"
Lateral File	15"	26 5/16"	9 1/8"

Filing Options (Diagram 3)

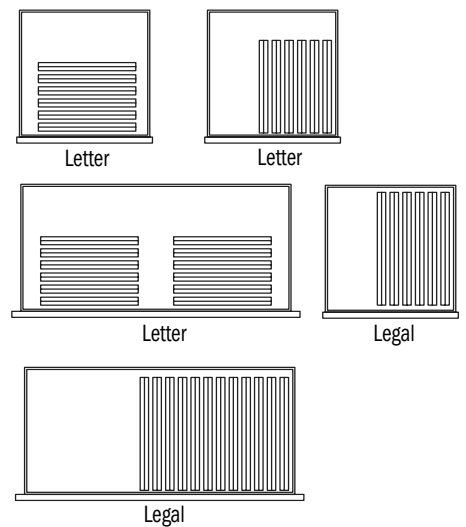


## Tall Storage Cabinets

Model	Description	Drawer Configuration
VV2418-57BBFTR	Storage Cabinet	Single Pedestal Width Box/Box/File
VV2418-57BBFTL	Storage Cabinet	Box/Box/File
VV2418-57FFTR	Storage Cabinet	File/File
VV2418-57FFTL	Storage Cabinet	File/File
VV2430-57WR	Wardrobe	(Right) Box/Box/File
VV2430-57WL	Wardrobe	(Left) Box/Box/File

Interior Drawer Dimensions	Depth	Width	Height
Box	15"	14 5/16"	3 1/4"
File	15"	14 5/16"	9 1/8"
Lateral File	15"	26 5/16"	9 1/8"

Filing Options (Diagram 3)



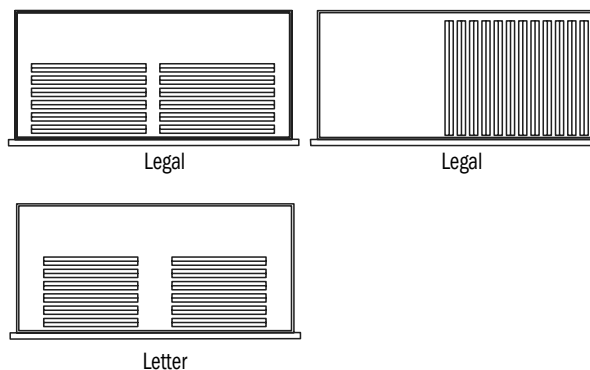
## Vision Veneer Product Information

### BENCH HEIGHT CABINET

Model	Description	Drawer Configuration
WB2436BF	Bench Height Cabinet	Box/Lateral File
WB2436OF	Bench Height Cabinet	Lateral File
WB2436MBF	Bench Height Cabinet	Box/Lateral File
WB2436MOF	Bench Height Cabinet	Lateral File
VB1836BF	Bench Height Cabinet	Box/Lateral File
VB1836OF	Bench Height Cabinet	Lateral File
VB1836MBF	Bench Height Cabinet	Box/Lateral File
VB1836MOF	Bench Height Cabinet	Lateral File

Interior Drawer Dimensions	Depth	Width	Height
Box	15"	32 5/16"	3 1/4"
Lateral File	15"	32 5/16"	9 1/8"

Filing Options (Diagram 5)

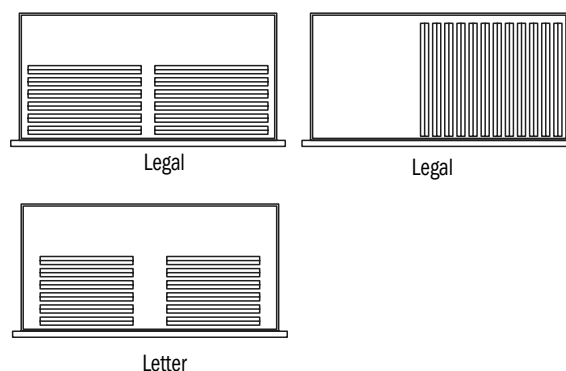


### BENCH HEIGHT CABINET

Model	Description	Drawer Configuration
WB2430BF	Bench Height Cabinet	Box/Lateral File
WB2430OF	Bench Height Cabinet	Lateral File
WB2430MBF	Bench Height Cabinet	Box/Lateral File
WB2430MOF	Bench Height Cabinet	Lateral File
VB1830BF	Bench Height Cabinet	Box/Lateral File
VB1830OF	Bench Height Cabinet	Lateral File
VB1830MBF	Bench Height Cabinet	Box/Lateral File
VB1830MOF	Bench Height Cabinet	Lateral File

Interior Drawer Dimensions	Depth	Width	Height
Box	15"	26 5/16"	3 1/4"
Lateral File	15"	26 5/16"	9 1/8"

Filing Options (Diagram 6)

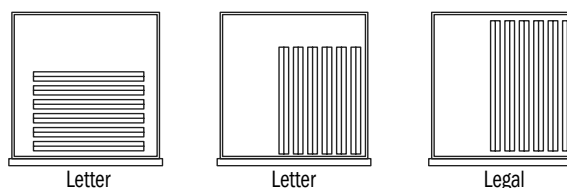


### BENCH HEIGHT CABINET

Model	Description	Drawer Configuration
VV2418BF	Bench Height Cabinet	Box/File
VV2418OF	Bench Height Cabinet	File
VV2418MBF	Bench Height Cabinet	Box/File
VV2418MOF	Bench Height Cabinet	File
VB1818BF	Bench Height Cabinet	Box/File
VB1818OF	Bench Height Cabinet	File
VB1818MBF	Bench Height Cabinet	Box/File
VB1818MOF	Bench Height Cabinet	File

Interior Drawer Dimensions	Depth	Width	Height
Box	15"	14 5/16"	3 1/4"
Lateral File	15"	14 5/16"	9 1/8"

Filing Options (Diagram 3)



## Vision Veneer Product Information

### ADDITIONAL BENCH HEIGHT CABINET

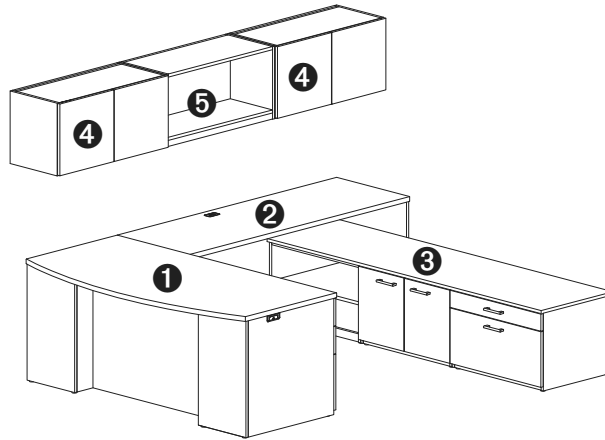
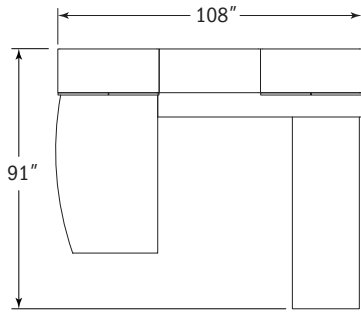
Model	Description Configuration	File Option Diagram Reference #
<b>60" w Units</b>		
WB-30BF30BF	(right) Box/File (left) Box/File	5
WB-300F300F	(right) File (left) File	5
WB-30BF300S	(right) File (left) Open Compartment	5
WB-300S30BF	(right) Open Compartment (left) File	5
<b>72" w Units</b>		
WB-36BF36BF	(right) Box/Lateral File (left) Box/Lateral File	6
WB-360F360F	(right) Lateral File (left) Lateral File	6
WB-36BF360S	(right) Box/Lateral File (left) Open Compartment	6
WB-360S36BF	(right) Open Compartment (left) Box/Lateral File	6
<b>72" w Units</b>		
WB-360S18BF18HR	(right) Open Compartment (center) Box/File (left) Hinge Door Compartment	4
WB-18HL18BF360S	(right) Hinge Door Compartment (center) Box/File (left) Open Compartment	4
<b>72" w Units</b>		
WB-36BF18BF180S	(right) Box/Lateral File (center) Box/File (left) Open Compartment	4
WB-180S18BF36BF	(right) Open Compartment (center) Box/File (left) Box/Lateral File	4
<b>72" w Units</b>		
WB-36BF180F180S	(right) Box/Lateral File (center) File (left) Open Compartment	4
WB-180S180F36BF	(right) Open Compartment (center) File (left) Box/Lateral File	4
<b>90" w Units</b>		
WB-300F300F300F	(right) Lateral File (center) Lateral File (left) Lateral File	6
WB-30BF300S30BF	(right) Box/Lateral File (center) Open Compartment (left) Box/Lateral File	3
WB-300F300S300F	(right) Lateral File (center) Open Compartment (left) Lateral File	6
WB-300S30HD30BF	(right) Open Compartment (center) Hinge Door Compartment (left) Lateral File	6
WB-30BF30HD300S	(right) Box/Lateral File (center) Hinge Door Compartment (left) Open Compartment	3
WB-30BF30SD300S	(right) Box/Lateral File (center) Sliding Door Compartment (left) Open Compartment	3
WB-300S30SD30BF	(right) Open Compartment (center) Sliding Door Compartment (left) Box/Lateral File	3

### Modular Drawer Sizes

Model	Description	Configuration	Interior Drawer Dimensions									File Option Diagram Reference #
			Box			File			Lateral File			
			d	w	h	d	w	h	d	w	h	
WV1630MBBF	Desk Pedestal	Box/Box/File	21"	12"	3 1/4"	21"	12"	9 1/8"	n/a	n/a	n/a	1
WV1630MFF	Desk Pedestal	File/File	n/a	n/a	n/a	21"	12"	9 1/8"	n/a	n/a	n/a	1
WV1624MBBF	Credenza Pedestal	Box/Box/File	15"	12"	3 1/4"	15"	12"	9 1/8"	n/a	n/a	n/a	2
WV3024MFF	Credenza Pedestal	File/File	n/a	n/a	n/a	15"	12"	9 1/8"	n/a	n/a	n/a	5
WV3624MLF	Lateral File - 36" Wide	Lat. File/Lat. File	n/a	n/a	n/a	n/a	n/a	n/a	15"	32 5/16"	9 1/8"	7
WV3024MLF	Lateral File - 30" Wide	Lat. File/Lat. File	n/a	n/a	n/a	n/a	n/a	n/a	15"	26 5/16"	9 1/8"	8
WV3624MBSC	Buffet Credenza	2 Top Box Drawers	15"	14 3/4"	3 1/4"	n/a	n/a	n/a	n/a	n/a	n/a	n/a

## Vision Veneer - Typicals

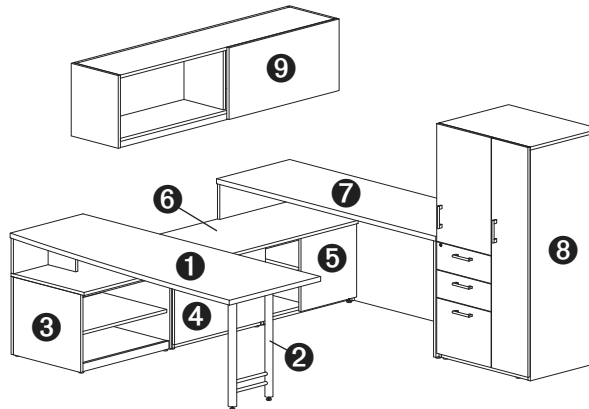
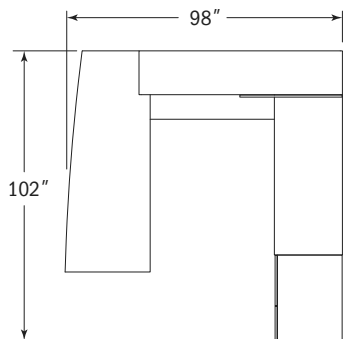
### VV001



Model	Description	Qty	Price
1 W3672LBD	bow front single pedestal desk with break front modesty, left	1	\$2,850
2 WV2472RSHR	shell return, right	1	\$1,323
3 WVB-300S30HD30BF	90" bench height configuration	1	\$2,760
4 WV1636WSO	wall mount overhead with two doors	2	\$2,426
5 WV1536WOO	wall mount open overhead	1	\$870
<b>Typical List Price</b>			<b>\$10,229</b>

VISION - VENEER

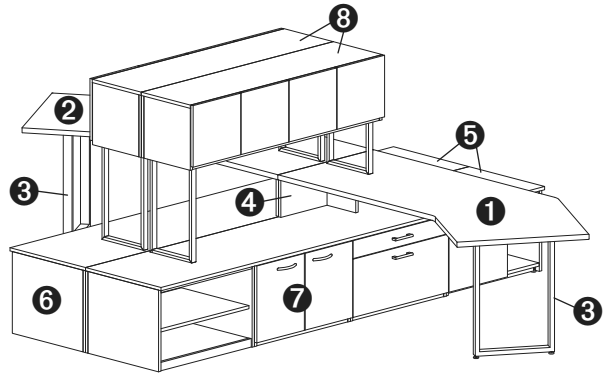
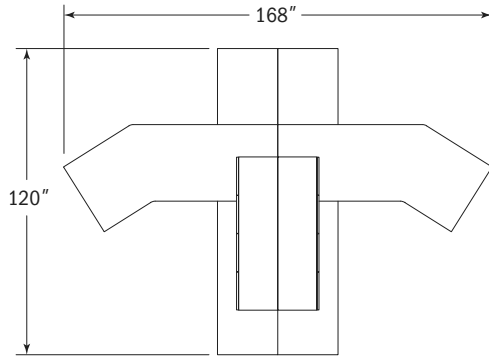
### VV002



Model	Description	Qty	Price
1 WVB3078FINL	bench height supported fin peninsula desk, left	1	\$2,137
2 18HS	H base	1	\$333
3 WVB2430MOS	open shelf bench height modular pedestal	1	\$642
4 WVB2430MBF	box/file bench height modular pedestal	1	\$913
5 WVB2430MSD	sliding door bench height modular pedestal	1	\$1,001
6 WVB2490MT	bench height modular top	1	\$454
7 WVB2472SHBR	bench height supported shell credenza, right	1	\$1,512
8 WV2430-57WR	57"h box/box/file storage wardrobe, right	1	\$3,341
9 WV1672WSD	wall mount overhead with sliding door	1	\$2,180
<b>Typical List Price</b>			<b>\$12,513</b>

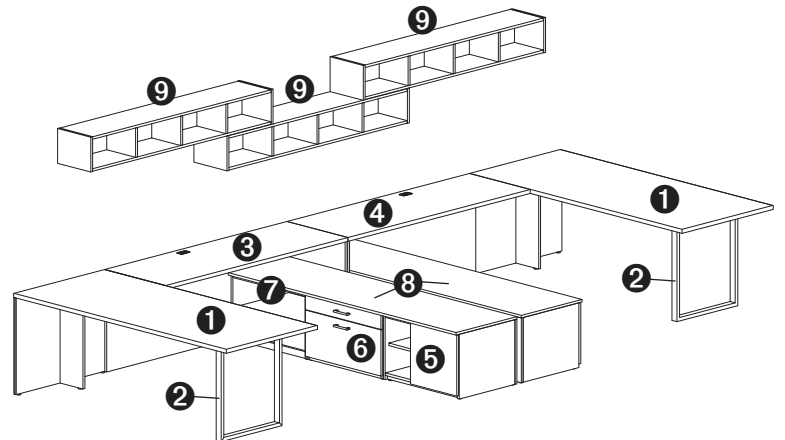
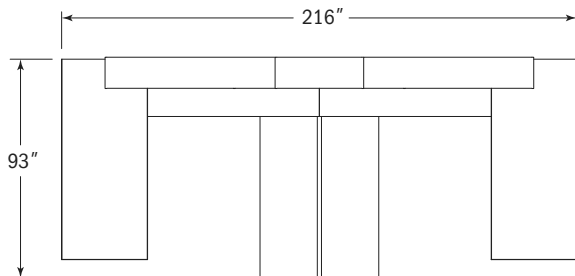
## Vision Veneer - Typical

### VV003



Model	Description	Qty	Price
1	VV3084MBMTR	modular boomerang desk top, right	1 \$2,270
2	VV3084MBMTL	modular boomerang desk top, left	1 \$2,270
3	18US	U base modular desk top	2 \$666
4	WVB1030TSP	bench height "T" support	2 \$848
5	WVB2430SD	bench height cabinet with sliding door	2 \$2,266
6	WB-30BF30HD300S	90" bench height configuration	1 \$2,760
7	WVB-300S30HD30BF	90" bench height configuration	1 \$2,760
8	WV1660PSHD-2737	split height post support overhead cabinet with four doors	2 \$4,224
<b>Typical List Price</b>			<b>\$18,064</b>

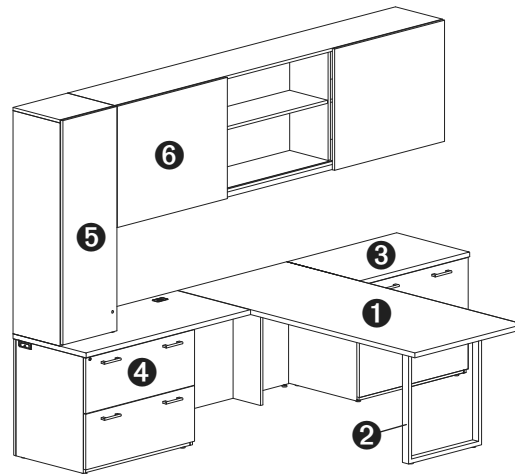
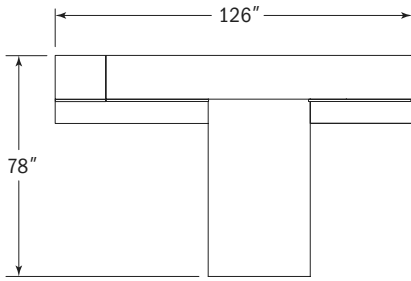
### VV004



Model	Description	Qty	Price
1	VV3684RCT	rectangle peninsula desk	2 \$3,802
2	24US	U base for peninsula desk	2 \$708
3	WVB2472LSHR	bench height supported shell return, left	1 \$1,323
4	WVB2472RSR	bench height supported shell return, right	1 \$1,323
5	WVB2430MSD	sliding door bench height modular pedestal	2 \$2,002
6	WVB2430MBF	box/file bench height modular pedestal	2 \$1,826
7	WVB2430MOS	open shelf bench height modular pedestal	2 \$1,284
8	WVB2490MT	90" bench height modular top	2 \$908
9	WV1072WCU	72" wall mount cubby	3 \$3,303
<b>Typical List Price</b>			<b>\$16,479</b>

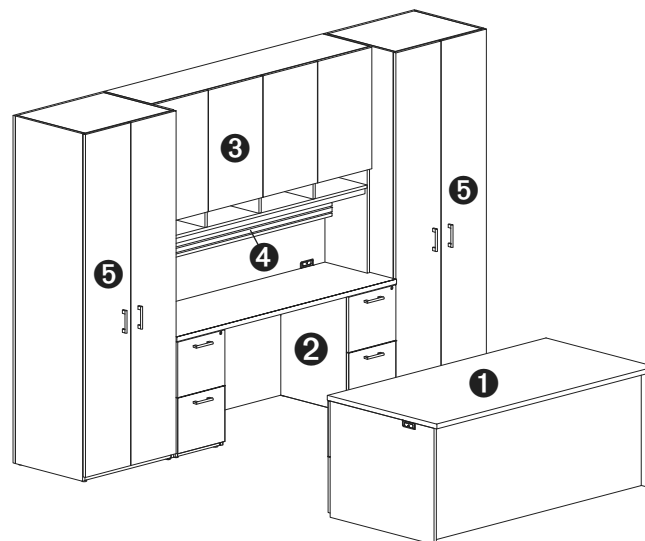
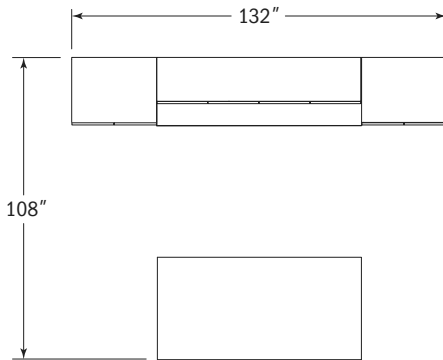
## Vision Veneer - Typical

### VV005



Model	Description	Qty	Price
1 VV3678RCT	rectangle peninsula desk	1	\$1,805
2 24US	U base for peninsula desk	1	\$354
3 WV2436-30LF	lateral file	1	\$1,756
4 WV2454LLR	lateral file return, left	1	\$2,024
5 WV1618DSTDL	double height storage tower, left	1	\$1,182
6 WV16108WSD	double height wall mount overhead cabinet w/ two sliding doors	1	\$4,175
<b>Typical List Price</b>			<b>\$11,296</b>

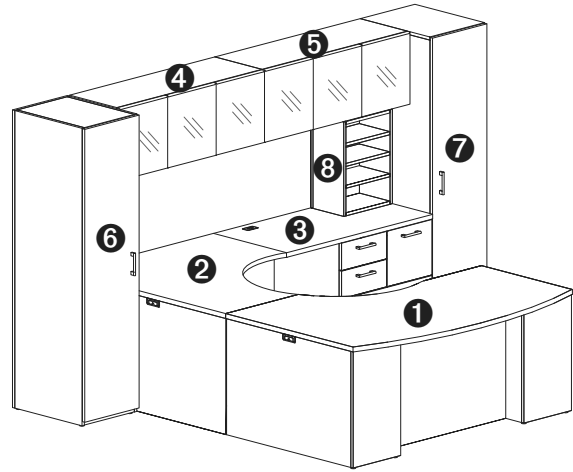
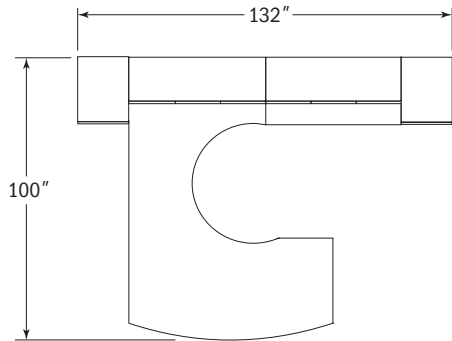
### VV006



Model	Description	Qty	Price
1 WV3672DDF	double pedestal desk with recessed modesty panel	1	\$2,729
2 WV2472KC	kneespace credenza	1	\$2,661
3 WV1672DSOC	double height storage overhead cabinet with four doors and cubbies	1	\$3,308
4 VS72AR	accessory rail	1	\$282
5 WV2430-84W	84" h wardrobe	2	\$5,990
<b>Typical List Price</b>			<b>\$14,970</b>

## Vision Veneer - Typical

### VV007

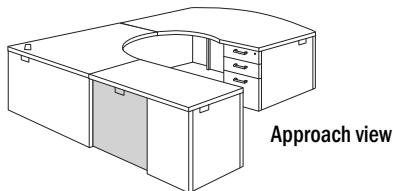


Model	Description	Qty	Price
1 VV4872CBDL	bow front cockpit single pedestal desk with break front modesty, left	1	\$2,982
2 VV4852ERCU	cockpit corner unit, right	1	\$1,950
3 VV2448MRCR	multi-file corner return, right	1	\$2,339
4 VV1648WGSOL	wall mount overhead with three frosted glass doors w/aluminum frame, left	1	\$2,110
5 VV1648WGSOR	wall mount overhead with three frosted glass doors w/aluminum frame, right	1	\$2,110
6 VV2418-72WL	72" h wardrobe, left	1	\$2,343
7 VV2418-72WR	72" h wardrobe, right	1	\$2,343
8 VV2016ST	storage tower insert/transaction support	1	\$700
<b>Typical List Price</b>			<b>\$16,877</b>



## Modular Modesty Panel Applications

### Returns with Breakfront



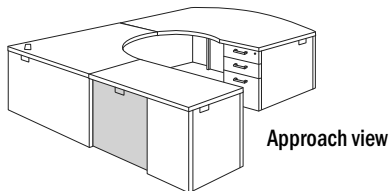
Consists of:  
 WV2442MCT - top  
 WV1624MFF - pedestal  
 WV2827MA - breakfront modesty panel

#### Modesty Panel Sizes for Returns with Pedestal

Top Width	Pedestal Width	Modesty Width	Modesty Height	Model Number
36	15 <sup>5</sup> / <sub>8</sub>	21 <sup>3</sup> / <sub>16</sub>	28	VV2821MA
42	15 <sup>5</sup> / <sub>8</sub>	27 <sup>3</sup> / <sub>16</sub>	28	VV2827MA
48	15 <sup>5</sup> / <sub>8</sub>	33 <sup>3</sup> / <sub>16</sub>	28	VV2833MA
54	15 <sup>5</sup> / <sub>8</sub>	39 <sup>3</sup> / <sub>16</sub>	28	VV2839MA
60	15 <sup>5</sup> / <sub>8</sub>	45 <sup>3</sup> / <sub>16</sub>	28	VV2845MA

VISION - VENEER

### Returns with Breakfront



Consists of:  
 WV2448MCT - top  
 WV3624MLF - pedestal  
 WV2812MA - modesty panel

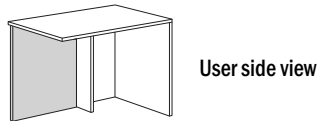
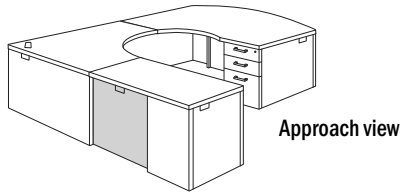
#### Modesty Panel Sizes for Returns with Lateral File Pedestal

Top Width	Pedestal 36" Wide	Modesty Width	Modesty Height	Model Number
42	35 <sup>7</sup> / <sub>8</sub>	6 <sup>15</sup> / <sub>16</sub>	28	VV2807MA
48	35 <sup>7</sup> / <sub>8</sub>	12 <sup>15</sup> / <sub>16</sub>	28	VV2812MA
54	35 <sup>7</sup> / <sub>8</sub>	18 <sup>15</sup> / <sub>16</sub>	28	VV2818MA
60	35 <sup>7</sup> / <sub>8</sub>	24 <sup>15</sup> / <sub>16</sub>	28	VV2824MA

Top Width	Pedestal 30" Wide	Modesty Width	Modesty Height	Model Number
36	29 <sup>7</sup> / <sub>8</sub>	6 <sup>15</sup> / <sub>16</sub>	28	VV2807MA
42	29 <sup>7</sup> / <sub>8</sub>	12 <sup>15</sup> / <sub>16</sub>	28	VV2812MA
48	29 <sup>7</sup> / <sub>8</sub>	18 <sup>15</sup> / <sub>16</sub>	28	VV2818MA
54	29 <sup>7</sup> / <sub>8</sub>	24 <sup>15</sup> / <sub>16</sub>	28	VV2824MA
60	29 <sup>7</sup> / <sub>8</sub>	30 <sup>15</sup> / <sub>16</sub>	28	VV2831MA

## Modular Modesty Panel Applications

### Return Shells with Breakfront

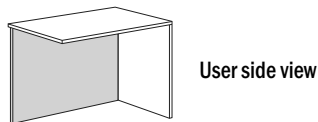
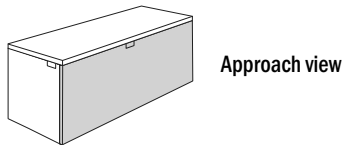


Consists of:  
 VV2442MCT - top  
 VV1624WEAR - wing end panel  
 VV2827MA - breakfront modesty panel

Modesty Panel Sizes for Return Shells using VV1624WEAL or VV1624WEAR wing end panel

Top Width	Wing Assembly Width	Modesty Width	Modesty Height	Model Number
36	15 <sup>5</sup> / <sub>8</sub>	21 <sup>3</sup> / <sub>16</sub>	28	VV2821MA
42	15 <sup>5</sup> / <sub>8</sub>	27 <sup>3</sup> / <sub>16</sub>	28	VV2827MA
48	15 <sup>5</sup> / <sub>8</sub>	33 <sup>3</sup> / <sub>16</sub>	28	VV2833MA
54	15 <sup>5</sup> / <sub>8</sub>	39 <sup>3</sup> / <sub>16</sub>	28	VV2839MA
60	15 <sup>5</sup> / <sub>8</sub>	45 <sup>3</sup> / <sub>16</sub>	28	VV2845MA

### Return Shells



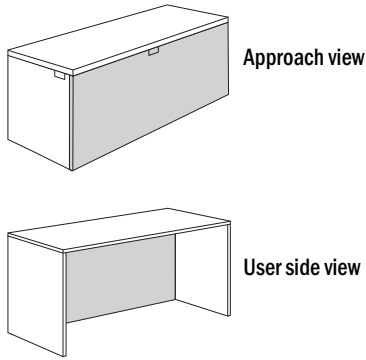
Consists of:  
 VV2442MCT - top  
 VV24EP - end panel  
 VV2843MA - modesty panel

Modesty Panel Sizes for Return Shells using VV24EP end panel

Top Width	End Panel Thickness VV24EP	Modesty Width	Modesty Height	Model Number
36	<sup>3</sup> / <sub>4</sub>	36 <sup>1</sup> / <sub>16</sub>	28	VV2837MA
42	<sup>3</sup> / <sub>4</sub>	42 <sup>1</sup> / <sub>16</sub>	28	VV2843MA
48	<sup>3</sup> / <sub>4</sub>	48 <sup>1</sup> / <sub>16</sub>	28	VV2849MA
54	<sup>3</sup> / <sub>4</sub>	54 <sup>1</sup> / <sub>16</sub>	28	VV2855MA

## Modular Modesty Panel Applications

### Desk Shells

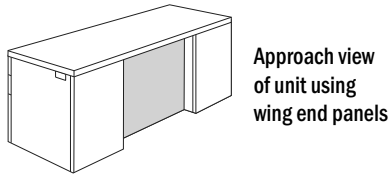


Consists of:  
 W2442MCT - top  
 W23EP - (2) end panels  
 W2842MA - modesty panel

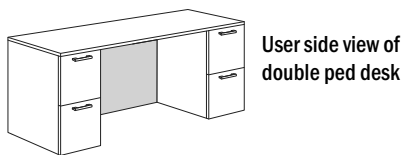
Modesty Panel Sizes for Desk Shells with both left and right ends using W23EP end panel

Top Width	End Panel Thickness W23EP	Modesty Width	Modesty Height	Model Number
30	3/4	29 7/8	28	VV2830MA
36	3/4	35 7/8	28	VV2836MA
42	3/4	41 7/8	28	VV2842MA
48	3/4	47 7/8	28	VV2848MA
54	3/4	53 7/8	28	VV2854MA
60	3/4	59 7/8	28	VV2860MA

### Desk Shells with Breakfront



Consists of:  
 W1630WEAL - left wing end panel  
 W1630WEAR - right wing end panel  
 W2840MA - breakfront modesty panel  
 W3072MCT - top



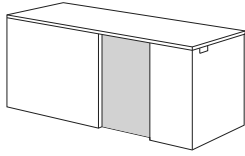
Consists of:  
 W1630MFF - (2) 30" deep modular pedestals  
 W2840MA - breakfront modesty panel  
 W3072MCT - top

Modular Breakfront Modesty Panel Sizes for double pedestal desks and credenzas -OR- Single pedestal desks and credenzas with the VV1630WEAL or VV1630WEAR wing end assembly or with the VV1624WEAL or VV1624WEAR wing end assembly

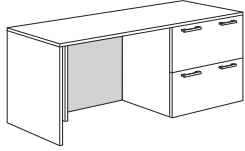
Top Width	Right or Left Pedestal or Wing End Assembly Width	Modesty Width	Modesty Height	Model Number
60	15 5/8	28 5/8	28	VV2828MA
66	15 5/8	34 5/8	28	VV2834MA
72	15 5/8	40 5/8	28	VV2840MA
78	15 5/8	46 5/8	28	VV2847MA
84	15 5/8	52 5/8	28	VV2853MA
90	15 5/8	58 5/8	28	VV2859MA

## Modular Modesty Panel Applications

### Credenza Shells with Breakfront



Approach view



User side view

**Consists of:**

VV3624MLF - pedestal

VV1642WEAL - wing end support ▲

VV2820MA - breakfront modesty panel ▲

VV2472MCT - top

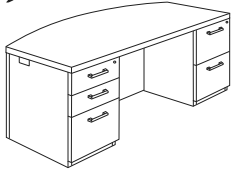
Modular Breakfront Modesty Panel Sizes for Single Pedestal Credenzas with 30" or 36" wide pedestal -OR- using the VV1624WEAL OR VV1624WEAR wing end assembly.

Top Width	36" Pedestal Width	Wing End Assembly Width	Modesty Width	Modesty Height	Model Number
66	35 <sup>7</sup> / <sub>8</sub>	15 <sup>5</sup> / <sub>8</sub>	14 <sup>3</sup> / <sub>8</sub>	28	VV2814MA
72	35 <sup>7</sup> / <sub>8</sub>	15 <sup>5</sup> / <sub>8</sub>	20 <sup>3</sup> / <sub>8</sub>	28	VV2820MA
78	35 <sup>7</sup> / <sub>8</sub>	15 <sup>5</sup> / <sub>8</sub>	26 <sup>3</sup> / <sub>8</sub>	28	VV2826MA
84	35 <sup>7</sup> / <sub>8</sub>	15 <sup>5</sup> / <sub>8</sub>	32 <sup>3</sup> / <sub>8</sub>	28	VV2832MA
90	35 <sup>7</sup> / <sub>8</sub>	15 <sup>5</sup> / <sub>8</sub>	38 <sup>3</sup> / <sub>8</sub>	28	VV2838MA
96	35 <sup>7</sup> / <sub>8</sub>	15 <sup>5</sup> / <sub>8</sub>	44 <sup>3</sup> / <sub>8</sub>	28	VV2844MA

Top Width	30" Pedestal Width	Wing End Assembly Width	Modesty Width	Modesty Height	Model Number
60	29 <sup>7</sup> / <sub>8</sub>	15 <sup>5</sup> / <sub>8</sub>	14 <sup>3</sup> / <sub>8</sub>	28	VV2814MA
66	29 <sup>7</sup> / <sub>8</sub>	15 <sup>5</sup> / <sub>8</sub>	20 <sup>3</sup> / <sub>8</sub>	28	VV2820MA
72	29 <sup>7</sup> / <sub>8</sub>	15 <sup>5</sup> / <sub>8</sub>	26 <sup>3</sup> / <sub>8</sub>	28	VV2826MA
78	29 <sup>7</sup> / <sub>8</sub>	15 <sup>5</sup> / <sub>8</sub>	32 <sup>3</sup> / <sub>8</sub>	28	VV2832MA
84	29 <sup>7</sup> / <sub>8</sub>	15 <sup>5</sup> / <sub>8</sub>	38 <sup>3</sup> / <sub>8</sub>	28	VV2838MA
90	29 <sup>7</sup> / <sub>8</sub>	15 <sup>5</sup> / <sub>8</sub>	44 <sup>3</sup> / <sub>8</sub>	28	VV2844MA
96	29 <sup>7</sup> / <sub>8</sub>	15 <sup>5</sup> / <sub>8</sub>	50 <sup>3</sup> / <sub>8</sub>	28	VV2850MA

Description	D	W	H	CTN WT	CU FT	① Model	Flat Cut List Price	Double Cut List Price
Bow Front Double Pedestal Desk with Break Front Modesty	42	72	30	435	61	VV4272BD	\$3,780	\$4,158
	36	84	30	435	61	VV3684BD	\$3,771	\$4,149
	36	72	30	392	53	VV3672BD	\$3,318	\$3,650

**Now!**



- top edge profile on user and approach sides
- two end panel grommets with wire pass thru
- letter width pedestals
- pedestal front locking
- 6" overhang on approach side
- VV4272BD chassis - 36" x 72"
- VV3684BD chassis - 30" x 84"
- VV3672BD chassis - 30" x 72"
- VV4272BD & VV3672BD kneespace - 40 5/8"
- VV3684BD kneespace - 52 5/8"
- optional 14" half modesty panel available in place of full modesty, specify half modesty on order
- trim modesty panel, see page 255

Bow Front Double Pedestal Desk with Recessed Modesty	42	72	30	435	61	VV4272BDF	\$3,615	\$3,977
	36	84	30	435	61	VV3684BDF	\$3,605	\$3,966
	36	72	30	392	53	VV3672BDF	\$3,153	\$3,469

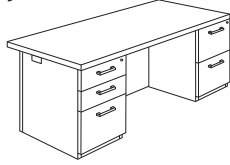
**Now!**



- top edge profile on user and approach sides
- two end panel grommets with wire pass thru
- letter width pedestals
- pedestal front locking
- full width modesty panel
- 6" overhang on approach side
- VV4272BDF chassis - 36" x 72"
- VV3684BDF chassis - 30" x 84"
- VV3672BDF chassis - 30" x 72"
- VV4272BDF & VV3672BDF kneespace - 40 5/8"
- VV3684BDF kneespace - 52 5/8"

Description	D	W	H	CTN WT	CU FT	① Model	Flat Cut List Price	Double Cut List Price
<b>Double Pedestal Desk with Break Front Modesty</b>	36	84	30	420	61	<b>VV3684DD</b>	\$3,125	\$3,438
	36	78	30	400	57	<b>VV3678DD</b>	\$3,103	\$3,414
	36	72	30	392	53	<b>VV3672DD</b>	\$2,895	\$3,185

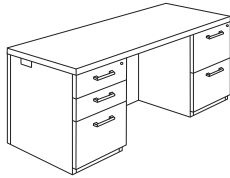
**NOW!**



- top edge profile on user and approach sides
- two end panel grommets with wire pass thru
- letter width pedestals
- pedestal front locking
- 6" overhang on approach side
- VV3684DD chassis - 30" x 84"
- VV3678DD chassis - 30" x 78"
- VV3672DD chassis - 30" x 72"
- VV3684DD kneespace - 52 5/8"
- VV3678DD kneespace - 46 5/8"
- VV3672DD kneespace - 40 5/8"
- optional 14" half modesty panel available in place of full modesty, specify half modesty on order
- trim modesty panel, see page 255

<b>Double Pedestal with Break Front Modesty</b>	30	72	30	368	44	<b>VV3072DD</b>	\$2,873	\$3,161
	30	66	30	289	41	<b>VV3066DD</b>	\$2,828	\$3,112
	30	60	30	289	37	<b>VV3060DD</b>	\$2,734	\$3,008

**NOW!**



- top edge profile on user and approach sides
- two end panel grommets with wire pass thru
- letter width pedestals
- pedestal front locking
- VV3072DD kneespace - 40 5/8"
- VV3066DD kneespace - 34 5/8"
- VV3060DD kneespace - 28 5/8"
- optional 14" half modesty panel available in place of full modesty, specify half modesty on order
- trim modesty panel, see page 255

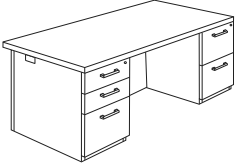
**To Order, Specify:**

- ① Model Number
- ② Wood Species - Cherry (CH1), Maple (MA1), Walnut (WA1) or Double Cut (see page 228)
- ③ Finish Color (see page 229)
- ④ Edge Profile (see page 233)
- ⑤ Pull Style and Color (see page 233)
- ⑥ Grommet Color - Matte Black (MBK) or Stardust Silver (STS) (see page 234)
- ⑦ Other Product Options (see page 229)
- ⑧ Keyboard Accessories (see page 407)
- ⑨ Power and Data Options (see page 407)

When ordering Quickship products, place a "Q" in front of model number.  
Example: QVV3072DD

**NOW!**  
*Need it.*  
JSI Quickship

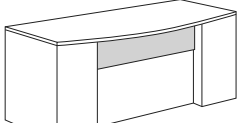
VISION - VENEER

Description	D	W	H	CTN WT	CU FT	① Model	Flat Cut List Price	Double Cut List Price
<b>Double Pedestal Desk with Recessed Modesty</b> 	36	84	30	420	61	VV3684DDF	\$2,959	\$3,255
	36	78	30	400	57	VV3678DDF	\$2,937	\$3,231
	36	72	30	392	53	VV3672DDF	\$2,729	\$3,002

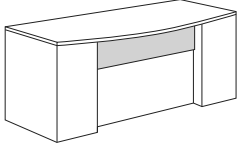
- top edge profile on user and approach sides
- two end panel grommets with wire pass thru
- letter width pedestals
- pedestal front locking
- full width modesty panel
- 3 3/4" overhang on approach side
- VV3684DDF chassis - 32 1/4" x 84"
- VV3678DDF chassis - 32 1/4" x 78"
- VV3672DDF chassis - 32 1/4" x 72"
- VV3684DDF kneespace - 52 5/8"
- VV3678DDF kneespace - 46 5/8"
- VV3672DDF kneespace - 40 5/8"

<b>Double Pedestal Desk with Recessed Modesty</b> 	30	72	30	368	44	VV3072DDF	\$2,707	\$2,978
	30	66	30	289	41	VV3066DDF	\$2,662	\$2,929
	30	60	30	289	37	VV3060DDF	\$2,568	\$2,825

- top edge profile on user and approach sides
- two end panel grommets with wire pass thru
- letter width pedestals
- pedestal front locking
- full width modesty panel
- 3 3/4" overhang on approach side
- VV3072DDF chassis - 26 1/4" x 72"
- VV3066DDF chassis - 26 1/4" x 66"
- VV3060DDF chassis - 26 1/4" x 60"
- VV3072DDF kneespace - 40 5/8"
- VV3066DDF kneespace - 34 5/8"
- VV3060DDF kneespace - 28 5/8"

Description	D	W	H	CTN WT	CU FT	① Model	List Price
Trim Modesty Panel	1/4	52	10	6	2	VS1052FMP	\$500
	1/4	46	10	5	2	VS1046FMP	\$478
	1/4	40	10	5	2	VS1040FMP	\$458
	1/4	34	10	4	1	VS1034FMP	\$438
	1/4	28	10	4	1	VS1028FMP	\$388

**NOW!**



- mounts in front of existing modesty panel on desk and credenza or alone in open kneespace area
- acrylic panel - frosted
- field installed
- VS1052FMP use with 84" desk
- VS1046FMP use with 78" desk
- VS1040FMP use with 72" desk
- VS1034FMP use with 66" desk
- VS1028FMP use with 60" desk

VISION - VENEER

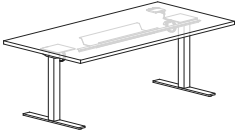
**To Order, Specify:**

- ① Model Number
- ② Wood Species - Cherry (CH1), Maple (MA1), Walnut (WA1) or Double Cut (see page 228)
- ③ Finish Color (see page 229)
- ④ Edge Profile (see page 233)
- ⑤ Pull Style and Color (see page 233)
- ⑥ Grommet Color - Matte Black (MBK) or Stardust Silver (STS) (see page 234)
- ⑦ Other Product Options (see page 229)
- ⑧ Accessories (see page 407)
- ⑨ Power and Data Options (see page 407)

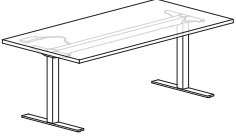
When ordering Quickship products, place a "Q" in front of model number.  
Example: QVV3072DD






Description	D	W	H	CTN WT	CU FT	① Model	Flat Cut List Price	Double Cut List Price
<b>Electric Adjustable Height Table Desk</b> 	36	72	Adj.	194	18	VV3672AHTD-EL	\$3,797	\$4,177
	30	72	Adj.	175	16	VV3072AHTD-EL	\$3,652	\$4,018
	30	66	Adj.	168	15	VV3066AHTD-EL	\$3,561	\$3,918
	30	60	Adj.	160	14	VV3060AHTD-EL	\$3,465	\$3,812
	24	72	Adj.	151	12	VV2472AHTD-EL	\$3,405	\$3,746
	24	66	Adj.	146	11	VV2466AHTD-EL	\$3,360	\$3,696
	24	60	Adj.	140	10	VV2460AHTD-EL	\$3,303	\$3,633

- 27 1/2" to 44 1/2" height adjustment
- top edge profile on user and approach sides
- push button control pad mounted right or left
- key pad features height display with four memory settings
- 72" power cord
- 225 lb. max load
- specify Black Sandtex (BSX) or Stardust Silver (STS) base finish
- ships KD

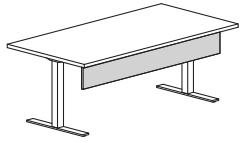
Description	D	W	H	CTN WT	CU FT	① Model	Flat Cut List Price	Double Cut List Price
<b>Pneumatic Adjustable Height Table Desk</b> 	36	72	Adj.	194	18	VV3672AHTD-PN	\$3,775	\$4,153
	30	72	Adj.	175	16	VV3072AHTD-PN	\$3,612	\$3,974
	30	66	Adj.	168	15	VV3066AHTD-PN	\$3,506	\$3,857
	30	60	Adj.	160	14	VV3060AHTD-PN	\$3,395	\$3,735
	24	72	Adj.	151	12	VV2472AHTD-PN	\$3,383	\$3,722
	24	66	Adj.	146	11	VV2466AHTD-PN	\$3,324	\$3,657
	24	60	Adj.	140	10	VV2460AHTD-PN	\$3,251	\$3,577

- 27 1/2" to 44 1/2" height adjustment
- top edge profile on user and approach sides
- release lever mounts under edge of top
- 225 lb. max load
- specify Matte Black or Alloy base finish
- ships KD

Description	D	W	H	CTN WT	CU FT	① Model	Flat Cut List Price	Double Cut List Price
<b>Crank Adjustable Height Table Desk</b> 	36	72	Adj.	194	18	VV3672AHTD-CR	\$2,787	\$3,066
	30	72	Adj.	175	16	VV3072AHTD-CR	\$2,638	\$2,903
	30	66	Adj.	168	15	VV3066AHTD-CR	\$2,541	\$2,796
	30	60	Adj.	160	14	VV3060AHTD-CR	\$2,440	\$2,684
	24	72	Adj.	151	12	VV2472AHTD-CR	\$2,373	\$2,611
	24	66	Adj.	146	11	VV2466AHTD-CR	\$2,328	\$2,561
	24	60	Adj.	140	10	VV2460AHTD-CR	\$2,268	\$2,495

- 27 1/2" to 44 1/2" height adjustment
- top edge profile on user and approach sides
- retractable handle
- 225 lb. max load
- specify Black Sandtex (BSX) or Stardust Silver (STS) base finish
- ships KD

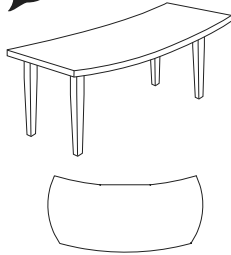
Description	D	W	H	CTN WT	CU FT	① Model	Flat Cut List Price	Double Cut List Price
Modesty Panel for Adjustable Height Tables	3/4	64	9	18	3	VV0964TDM	\$546	\$601
	3/4	58	9	16	2	VV0958TDM	\$529	\$582
	3/4	52	9	14	2	VV0952TDM	\$512	\$563



- VV0964TDM use with 72" wide adjustable height desk
- VV0958TDM use with 66" wide adjustable height desk
- VV0952TDM use with 60" wide adjustable height desk
- flat edge detail
- modesty panel bracket is available in Black Sandtex (BSX) or Stardust Silver (STS)

Table Desk	D	W	H	CTN WT	CU FT	Model	List Price
	36	72	30	176	35	VV3672TD	\$2,018
	30	66	30	168	41	VV3066TD	\$1,877

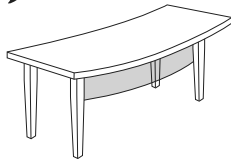
**NOW!**



- top edge profile on user and approach sides
- trim modesty panel available; see below
- includes matching finish wood legs

Trim Modesty Panel	D	W	H	CTN WT	CU FT	Model	List Price
	1/4	56	10	8	2	VS1072FMP	\$515
	1/4	54	10	8	2	VS1066FMP	\$506

**NOW!**



- VS1072FMP used with 72" table desk
- VS1066FMP used with 66" table desk
- acrylic panel - frosted
- field installed

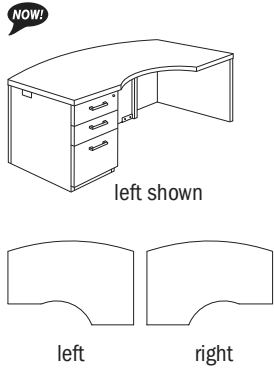
**To Order, Specify:**

- ① Model Number
- ② Wood Species - Cherry (CH1), Maple (MA1), Walnut (WA1) or Double Cut (see page 228)
- ③ Finish Color (see page 229)
- ④ Edge Profile (see page 233)
- ⑤ Metal Color (see page 237)
- ⑥ Other Product Options (see page 229)

When ordering Quickship products, place a "Q" in front of model number.  
Example: QVV3072DD

**NOW!**  
*Need it.*  
JSI Quickship

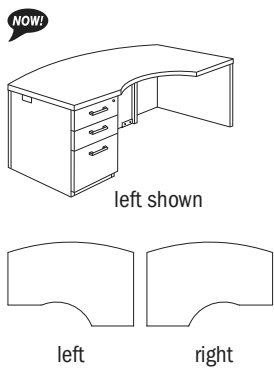
Description	D	W	H	CTN WT	CU FT	① Model	Flat Cut List Price	Double Cut List Price
<b>Bow Front Cockpit Single Pedestal Desk with Break Front Modesty</b>	48	72	30	312	66	VV4872CBDR	\$2,982	\$3,281
	48	72	30	312	66	VV4872CDDL	\$2,982	\$3,281



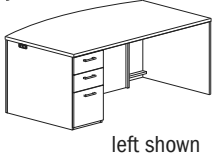
- cockpit style wrap around top
- top edge profile on user and approach sides
- two end panel grommets
- letter width pedestal
- pedestal front locking
- 6" overhang on approach side
- chassis - 42" x 72"
- optional 14" half modesty panel available in place of full modesty, specify half modesty on order
- trim modesty panel, see page 261

VISION - VENEER

<b>Bow Front Cockpit Single Pedestal Desk with Recessed Modesty</b>	48	72	30	312	66	VV4872CBDRF	\$2,817	\$3,099
	48	72	30	312	66	VV4872CBDLF	\$2,817	\$3,099




- cockpit style wrap around top
- top edge profile on user and approach sides
- two end panel grommets
- letter width pedestal
- pedestal front locking
- full width modesty panel
- 6" overhang on approach side
- chassis - 42" x 72"

Description	D	W	H	CTN WT	CU FT	① Model	Flat Cut List Price	Double Cut List Price
<b>Bow Front Single Pedestal Desk with Break Front Modesty</b>	42	72	30	365	61	VW4272RBD	\$3,284	\$3,612
	42	72	30	365	61	VW4272LBD	\$3,284	\$3,612
 left shown	36	84	30	365	61	VW3684RBD	\$3,270	\$3,598
	36	84	30	365	61	VW3684LBD	\$3,270	\$3,598
	36	72	30	351	53	VW3672RBD	\$2,850	\$3,136
	36	72	30	351	53	VW3672LBD	\$2,850	\$3,136

**NOW!**

- top edge profile on user and approach sides
- two end panel grommets with wire pass thru
- letter width pedestals
- pedestal front locking
- 6" overhang on approach side
- VW4272RBD & VW4272LBD chassis - 36" x 72"
- VW3684RBD & VW3684LBD chassis - 30" x 84"
- VW3672RBD & VW3672LBD chassis - 30" x 72"
- optional 14" half modesty panel available in place of full modesty, specify half modesty on order
- trim modesty panel, see page 261

<b>Bow Front Single Pedestal Desk with Recessed Modesty</b>	42	72	30	365	61	VW4272RBDF	\$3,118	\$3,430
	42	72	30	365	61	VW4272LBDF	\$3,118	\$3,430
 left shown	36	84	30	365	61	VW3684RBDF	\$3,104	\$3,415
	36	84	30	365	61	VW3684LBDF	\$3,104	\$3,415
	36	72	30	351	53	VW3672RBDF	\$2,684	\$2,953
	36	72	30	351	53	VW3672LBDF	\$2,684	\$2,953

**NOW!**

- top edge profile on user and approach sides
- two end panel grommets with wire pass thru
- letter width pedestals
- pedestal front locking
- full width modesty panel
- 6" overhang on approach side
- VW4272RBDF & VW4272LBDF chassis - 36" x 72"
- VW3684RBDF & VW3684LBDF chassis - 30" x 84"
- VW3672RBDF & VW3672LBDF chassis - 30" x 72"

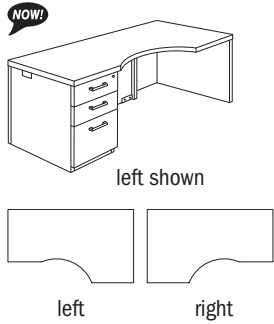
**To Order, Specify:**

- ① Model Number
- ② Wood Species - Cherry (CH1), Maple (MA1), Walnut (WA1) or Double Cut (see page 228)
- ③ Finish Color (see page 229)
- ④ Edge Profile (see page 233)
- ⑤ Pull Style and Color (see page 233)
- ⑥ Grommet Color - Matte Black (MBK) or Stardust Silver (STS) (see page 234)
- ⑦ Other Product Options (see page 229)
- ⑧ Keyboard Accessories (see page 407)
- ⑨ Power and Data Options (see page 407)

When ordering Quickship products, place a "Q" in front of model number.  
Example: QVW3072DD

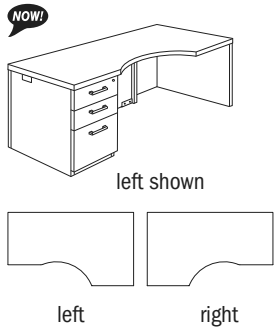
**NOW!**  
*Need it.*  
JSI Quickship

Description	D	W	H	CTN WT	CU FT	① Model	Flat Cut List Price	Double Cut List Price
<b>Cockpit Single Pedestal Desk with Break Front Modesty</b>	42	72	30	308	61	VV4272CRD	\$2,902	\$3,192
	42	72	30	308	61	VV4272CLD	\$2,902	\$3,192



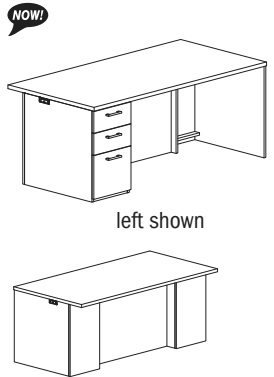
- cockpit style wrap around top
- top edge profile on user and approach sides
- two end panel grommets with wire pass thru
- letter width pedestal
- pedestal front locking
- optional 14" half modesty panel available in place of full modesty, specify half modesty on order
- trim modesty panel, see page 261

<b>Cockpit Single Pedestal Desk with Recessed Modesty</b>	42	72	30	308	63	VV4272CRDF	\$2,736	\$3,010
	42	72	30	308	63	VV4272CLDF	\$2,736	\$3,010



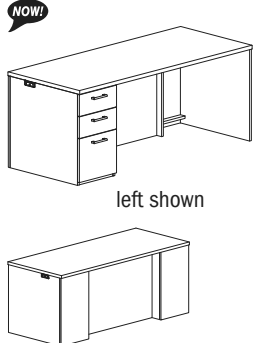
- cockpit style wrap around top
- top edge profile on user and approach sides
- two end panel grommets with wire pass thru
- letter width pedestal
- pedestal front locking
- full width modesty panel

<b>36" d Pedestal Desk with Break Front Modesty</b>	36	84	30	325	61	VV3684RD	\$2,744	\$3,019
	36	84	30	325	61	VV3684LD	\$2,744	\$3,019
	36	72	30	302	53	VV3672RD	\$2,488	\$2,737
	36	72	30	302	53	VV3672LD	\$2,488	\$2,737



- top edge profile on user and approach sides
- two end panel grommets with wire pass thru
- letter width pedestal
- pedestal front locking
- 6" overhang on approach side
- VV3684RD or VV3684LD chassis - 30" x 84"
- VV3672RD or VV3672LD chassis - 30" x 72"
- optional 14" half modesty panel available in place of full modesty, specify half modesty on order
- trim modesty panel, see page 261

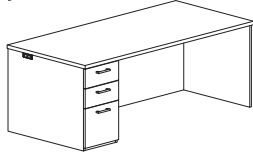
<b>30" d Pedestal Desk with Break Front Modesty</b>	30	72	30	290	44	VV3072RD	\$2,441	\$2,685
	30	72	30	290	44	VV3072LD	\$2,441	\$2,685
	30	66	30	262	41	VV3066RD	\$2,305	\$2,536
	30	66	30	262	41	VV3066LD	\$2,305	\$2,536



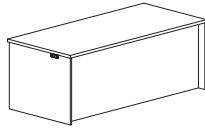
- top edge profile on user and approach sides
- two end panel grommets with wire pass thru
- letter width pedestal
- pedestal front locking
- optional 14" half modesty panel available in place of full modesty, specify half modesty on order
- trim modesty panel, see page 261

Description	D	W	H	CTN WT	CU FT	① Model	Flat Cut List Price	Double Cut List Price
36" d Pedestal Desk with Recessed Modesty	36	84	30	325	61	WV3684RDF	\$2,578	\$2,837
	36	84	30	325	61	WV3684LDF	\$2,578	\$2,837
	36	72	30	302	53	WV3672RDF	\$2,322	\$2,555
	36	72	30	302	53	WV3672LDF	\$2,322	\$2,555

NOW!



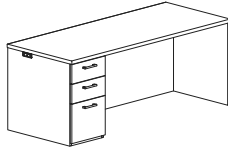
left shown



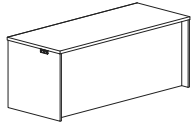
- top edge profile on user and approach sides
- two end panel grommets with wire pass thru
- letter width pedestal
- pedestal front locking
- full width modesty panel

30" d Pedestal Desk with Recessed Modesty	30	72	30	290	44	WV3072RDF	\$2,275	\$2,503
	30	72	30	290	44	WV3072LDF	\$2,275	\$2,503
	30	66	30	262	41	WV3066RDF	\$2,139	\$2,354
	30	66	30	262	41	WV3066LDF	\$2,139	\$2,354

NOW!



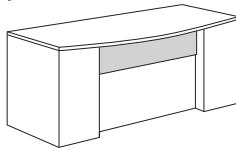
left shown



- top edge profile on user and approach sides
- two end panel grommets with wire pass thru
- letter width pedestal
- pedestal front locking
- full width modesty panel

							List Price
Trim Modesty Panel	1/4	52	10	6	2	VS1052FMP	\$500
	1/4	40	10	5	2	VS1040FMP	\$458
	1/4	34	10	4	1	VS1034FMP	\$438

NOW!



- mounts in front of existing modesty panel
- acrylic panel - frosted
- field installed
- VS1052FMP use with 84" single pedestal desk
- VS1040FMP use with 72" single pedestal desk
- VS1034FMP use with 66" single pedestal desk

**To Order, Specify:**

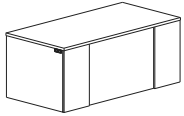
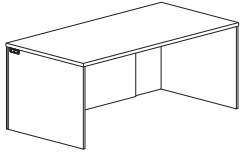
- ① Model Number
- ② Wood Species - Cherry (CH1), Maple (MA1), Walnut (WA1) or Double Cut (see page 228)
- ③ Finish Color (see page 229)
- ④ Edge Profile (see page 233)
- ⑤ Pull Style and Color (see page 233)
- ⑥ Grommet Color - Matte Black (MBK) or Stardust Silver (STS) (see page 234)
- ⑦ Other Product Options (see page 229)
- ⑧ Keyboard Accessories (see page 407)
- ⑨ Power and Data Options (see page 407)

When ordering Quickship products, place a "Q" in front of model number.  
Example: QV3072DD

**NOW!**  
Need it.  
JSI Quickship

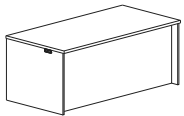
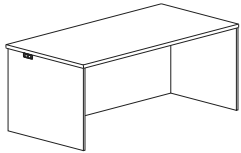
VISION - VENEER

Description	D	W	H	CTN WT	CU FT	① Model	Flat Cut List Price	Double Cut List Price
Shell Desk with Break Front Modesty <b>NOW!</b>	36	72	30	205	53	VV3672SHD	\$1,866	\$2,053
	30	72	30	192	44	VV3072SHD	\$1,821	\$2,004
	30	66	30	179	41	VV3066SHD	\$1,754	\$1,929
	30	60	30	168	41	VV3060SHD	\$1,730	\$1,903



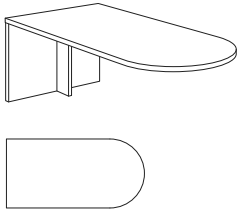
- top edge profile on user and approach sides
- two end panel grommets
- optional 14" half modesty panel available in place of full modesty, specify half modesty on order
- trim modesty panel; see page 261
- shell units are not designed to accept modular pedestals from pages 287 and 288 ▲

Shell Desk with Recessed Modesty <b>NOW!</b>	36	72	30	205	53	VV3672SHDF	\$1,700	\$1,871
	30	72	30	192	44	VV3072SHDF	\$1,655	\$1,821
	30	66	30	179	41	VV3066SHDF	\$1,588	\$1,748
	30	60	30	168	41	VV3060SHDF	\$1,564	\$1,720

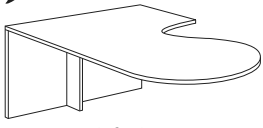


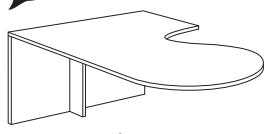
- top edge profile on user and approach sides
- two end panel grommets
- full width modesty panel
- shell units are not designed to accept modular pedestals from pages 287 and 288 ▲

VISION - VENEER

Description	D	W	H	CTN WT	CU FT	① Model	Flat Cut List Price	Double Cut List Price
<b>Bullet Peninsula Desk</b> 	36	84	30	175	61	<b>VW3684B</b>	\$2,599	\$2,860
	36	78	30	169	57	<b>VW3678B</b>	\$2,530	\$2,783
	36	72	30	163	53	<b>VW3672B</b>	\$2,151	\$2,366
	30	84	30	168	51	<b>VW3084B</b>	\$2,433	\$2,677
	30	78	30	163	48	<b>VW3078B</b>	\$2,357	\$2,593
	30	72	30	158	44	<b>VW3072B</b>	\$2,072	\$2,280
	30	66	30	152	41	<b>VW3066B</b>	\$1,895	\$2,085

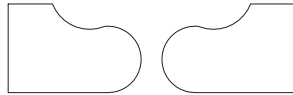
- top edge profile on three open sides
- one end panel grommet
- non-handed
- not recommended for freestanding use
- trim modesty panel, see page 265
- bases must be purchased separately; see page 265 for options

<b>Cockpit Bullet Peninsula Desk</b> 	48	72	30	175	66	<b>VW4872CBR</b>	\$2,564	\$2,821
	48	72	30	175	66	<b>VW4872CBL</b>	\$2,564	\$2,821



left shown

- cockpit style wrap around top
- edge profile on three open sides
- one end panel grommet
- not recommended for freestanding use
- trim modesty panel, see page 265
- bases must be purchased separately; see page 265 for options



left

right

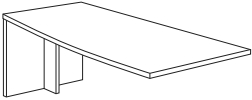
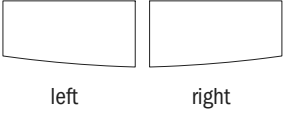
**To Order, Specify:**

- ① Model Number
- ② Wood Species - Cherry (CH1), Maple (MA1), Walnut (WA1) or Double Cut (see page 228)
- ③ Finish Color (see page 229)
- ④ Edge Profile (see page 233)
- ⑤ Grommet Color - Matte Black (MBK) or Stardust Silver (STS) (see page 234)
- ⑥ Other Product Options (see page 229)
- ⑦ Accessories (see page 407)
- ⑧ Power and Data Options (see page 407)

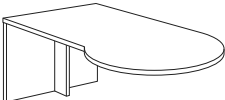
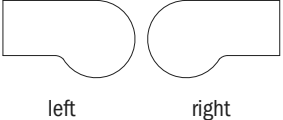
When ordering Quickship products, place a "Q" in front of model number.  
 Example: QVW3072DD



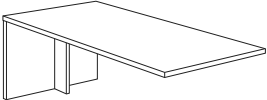



Description	D	W	H	CTN WT	CU FT	① Model	Flat Cut List Price	Double Cut List Price
<b>Fin Peninsula Desk</b>  left shown   left      right	36	84	30	176	61	VV3684FINR	\$2,496	\$2,746
	36	84	30	176	61	VV3684FINL	\$2,496	\$2,746
	36	78	30	170	57	VV3678FINR	\$2,427	\$2,671
	36	78	30	170	57	VV3678FINL	\$2,427	\$2,671
	36	72	30	164	53	VV3672FINR	\$2,198	\$2,419
	36	72	30	164	53	VV3672FINL	\$2,198	\$2,419
	30	84	30	169	51	VV3084FINR	\$2,349	\$2,585
	30	84	30	169	51	VV3084FINL	\$2,349	\$2,585
	30	78	30	164	48	VV3078FINR	\$2,264	\$2,491
	30	78	30	164	48	VV3078FINL	\$2,264	\$2,491
	30	72	30	159	44	VV3072FINR	\$2,051	\$2,257
	30	72	30	159	44	VV3072FINL	\$2,051	\$2,257

- 30" deep at end panel for 36" deep top
- 24" deep at end panel for 30" deep top
- arch on approach side
- edge profile on three open sides
- one end panel grommet
- not recommended for freestanding use
- trim modesty panel, see page 265
- bases must be purchased separately; see page 265 for options

<b>P-Top Peninsula Desk</b>  left shown   left      right	42	84	30	190	71	VV4284RP	\$2,740	\$3,014
	42	84	30	190	71	VV4284LP	\$2,740	\$3,014
	42	78	30	184	66	VV4278RP	\$2,645	\$2,910
	42	78	30	184	66	VV4278LP	\$2,645	\$2,910
	42	72	30	175	61	VV4272RP	\$2,492	\$2,742
	42	72	30	175	61	VV4272LP	\$2,492	\$2,742

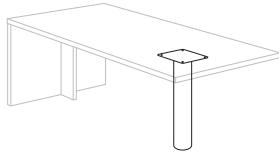
- 42" at widest point
- 30" at end panel
- edge profile on three open sides
- one end panel grommet
- not recommended for freestanding use
- trim modesty panel, see page 265
- bases must be purchased separately; see page 265 for options

<b>Rectangle Peninsula Desk</b>   	36	84	30	176	61	VV3684RCT	\$1,901	\$2,091
	36	78	30	170	57	VV3678RCT	\$1,805	\$1,986
	36	72	30	164	53	VV3672RCT	\$1,729	\$1,902
	30	84	30	169	51	VV3084RCT	\$1,806	\$1,987
	30	78	30	164	48	VV3078RCT	\$1,745	\$1,920
	30	72	30	159	44	VV3072RCT	\$1,697	\$1,867

- edge profile on three open sides
- one end panel grommet
- non-handed
- not recommended for freestanding use
- trim modesty panel, see page 265
- bases must be purchased separately; see page 265 for options

Bases for Peninsula Tops

**NOW!**

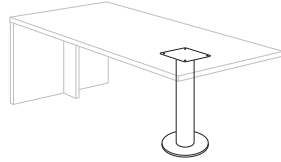


Column Base

- 04BB - Black Sandtex - \$321
- 04SB - Stardust Silver - \$321

Base:

- 13 gauge steel
- 4" diameter

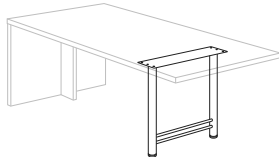


Column Disk Base

- 12DB - Black Sandtex - \$385
- 12DS - Stardust Silver - \$385

Base:

- support disk: 11" diameter

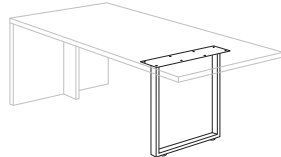


H Base

- use with 36" or 48" deep tops
- 24HB - Black Sandtex - \$354
- 24HS - Stardust Silver - \$354

use with 30" deep tops

- 18HB - Black Sandtex - \$333
- 18HS - Stardust Silver - \$333

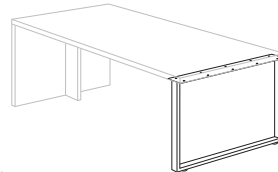


U Base

- use with 36" or 48" deep tops
- 24UB - Black Sandtex - \$354
- 24US - Stardust Silver - \$354

use with 30" deep tops

- 18UB - Black Sandtex - \$333
- 18US - Stardust Silver - \$333



▲ Rectangular Base

- use with 36" deep tops
- 36FSQB - Black Sandtex - \$473
- 36FSQS - Stardust Silver - \$473

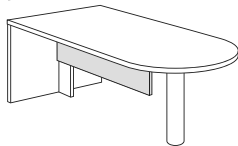
use with 30" deep tops

- 30FSQB - Black Sandtex - \$457
- 30FSQS - Stardust Silver - \$457

\*\* should not be used with fin shaped tops

Description	D	W	H	CTN WT	CU FT	① Model	List Price
Trim Modesty Panel for Peninsula Tops	1/4	52	10	6	2	VS1052FMP	\$500
	1/4	46	10	5	2	VS1046FMP	\$478
	1/4	40	10	5	2	VS1040FMP	\$458
	1/4	34	10	4	1	VS1034FMP	\$438

**NOW!**



- mounts in open kneespace area
- acrylic panel - frosted
- field installed
- VS1052FMP use with 84" bullet, fin, P-top or rectangle peninsula desk
- VS1046FMP use with 78" bullet, fin, P-top or rectangle peninsula desk
- VS1040FMP use with 72" bullet, fin, P-top or rectangle peninsula desk
- VS1034FMP use with 66" bullet, fin, P-top or rectangle peninsula desk

To Order, Specify:


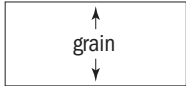
- ① Model Number
- ② Wood Species - Cherry (CH1), Maple (MA1), Walnut (WA1) or Double Cut (see page 228)
- ③ Finish Color (see page 229)
- ④ Edge Profile (see page 233)
- ⑤ Other Product Options (see page 229)
- ⑥ Accessories (see page 407)
- ⑦ Power and Data Options (see page 407)

When ordering Quickship products, place a "Q" in front of model number.  
Example: QVV3072DD

**NOW!**  
Need it.  
JSI Quickship

Description	D	W	H	CTN WT	CU FT	① Model	Flat Cut List Price	Double Cut List Price
File/File Return	24	60	30	190	30	VV2460ERR	\$1,855	\$2,041
 24	60	30	190	30	VV2460ELR	\$1,855	\$2,041	
	24	54	30	179	27	VV2454ERR	\$1,804	\$1,985
left shown	24	54	30	179	27	VV2454ELR	\$1,804	\$1,985
	24	48	30	168	25	VV2448ERR	\$1,725	\$1,898
	24	48	30	168	25	VV2448ELR	\$1,725	\$1,898
	24	42	30	155	22	VV2442ERR	\$1,675	\$1,843
	24	42	30	155	22	VV2442ELR	\$1,675	\$1,843
	20	60	30	173	26	VV2060ERR	\$1,781	\$1,960
	20	60	30	173	26	VV2060ELR	\$1,781	\$1,960
	20	54	30	163	23	VV2054ERR	\$1,733	\$1,906
	20	54	30	163	23	VV2054ELR	\$1,733	\$1,906
	20	48	30	154	21	VV2048ERR	\$1,656	\$1,822
	20	48	30	154	21	VV2048ELR	\$1,656	\$1,822
	20	42	30	142	18	VV2042ERR	\$1,609	\$1,771
	20	42	30	142	18	VV2042ELR	\$1,609	\$1,771

- top edge profile on user side
- short grain direction
- one end and back panel grommet with wire pass thru
- one surface grommet
- letter width file/file pedestal
- pedestal front locking
- optional 10" modesty panel available in place of full modesty, specify 10" modesty on order

Description	D	W	H	CTN WT	CU FT	① Model	Flat Cut List Price	Double Cut List Price
Box/Box/File Return	24	60	30	190	30	VW2460ERY	\$1,855	\$2,041
<b>NOW!</b>	24	60	30	190	30	VW2460ELY	\$1,855	\$2,041
 <p>left shown</p> 	24	54	30	179	27	VW2454ERY	\$1,804	\$1,985
	24	54	30	179	27	VW2454ELY	\$1,804	\$1,985
	24	48	30	168	25	VW2448ERY	\$1,725	\$1,898
	24	48	30	168	25	VW2448ELY	\$1,725	\$1,898
	24	42	30	155	22	VW2442ERY	\$1,675	\$1,843
	24	42	30	155	22	VW2442ELY	\$1,675	\$1,843
	20	60	30	173	26	VW2060ERY	\$1,781	\$1,960
	20	60	30	173	26	VW2060ELY	\$1,781	\$1,960
	20	54	30	163	23	VW2054ERY	\$1,733	\$1,906
	20	54	30	163	23	VW2054ELY	\$1,733	\$1,906
20	48	30	154	21	VW2048ERY	\$1,656	\$1,822	
20	48	30	154	21	VW2048ELY	\$1,656	\$1,822	
20	42	30	142	18	VW2042ERY	\$1,609	\$1,771	
20	42	30	142	18	VW2042ELY	\$1,609	\$1,771	

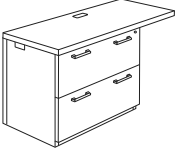
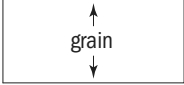
- top edge profile on user side
- short grain direction
- one end and back panel grommet with wire pass thru
- one surface grommet
- letter width box/box/file pedestal
- pedestal front locking
- optional 10" modesty panel available in place of full modesty, specify 10" modesty on order

**To Order, Specify:**


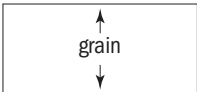
- ① Model Number
- ② Wood Species - Cherry (CH1), Maple (MA1), Walnut (WA1) or Double Cut (see page 228)
- ③ Finish Color (see page 229)
- ④ Edge Profile (see page 233)
- ⑤ Pull Style and Color (see page 233)
- ⑥ Grommet Color - Matte Black (MBK) or Stardust Silver (STS) (see page 234)
- ⑦ Other Product Options (see page 229)
- ⑧ Accessories (see page 407)
- ⑨ Power and Data Options (see page 407)

When ordering Quickship products, place a "Q" in front of model number.  
Example: QV3072DD

**NOW!**  
*Need it.*  
JSI Quickship

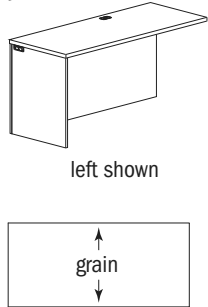
Description	D	W	H	CTN WT	CU FT	① Model	Flat Cut List Price	Double Cut List Price
<b>Lateral File Return</b>  left shown 	24	60	30	199	30	VV2460LRR	\$2,103	\$2,314
	24	60	30	199	30	VV2460LLR	\$2,103	\$2,314
	24	54	30	187	27	VV2454LRR	\$2,024	\$2,226
	24	54	30	187	27	VV2454LLR	\$2,024	\$2,226
	24	48	30	175	25	VV2448LRR	\$1,973	\$2,171
	24	48	30	175	25	VV2448LLR	\$1,973	\$2,171
	20	60	30	188	26	VV2060LRR	\$2,019	\$2,221
	20	60	30	188	26	VV2060LLR	\$2,019	\$2,221
	20	54	30	177	23	VV2054LRR	\$1,943	\$2,137
	20	54	30	177	23	VV2054LLR	\$1,943	\$2,137
	20	48	30	164	21	VV2048LRR	\$1,896	\$2,086
	20	48	30	164	21	VV2048LLR	\$1,896	\$2,086

- top edge profile on user side
- short grain direction
- one end and back panel grommet with wire pass thru
- one surface grommet
- 36" width lateral file
- pedestal front locking
- optional 10" modesty panel available in place of full modesty, specify 10" modesty on order

<b>Multi-File Return</b>  left shown 	24	60	30	202	30	VV2460MLR	\$2,469	\$2,717
	24	60	30	202	30	VV2460MLL	\$2,469	\$2,717
	24	54	30	190	27	VV2454MLR	\$2,419	\$2,661
	24	54	30	190	27	VV2454MLL	\$2,419	\$2,661
	24	48	30	179	25	VV2448MLR	\$2,339	\$2,573
	24	48	30	179	25	VV2448MLL	\$2,339	\$2,573
	20	60	30	191	26	VV2060MLR	\$2,370	\$2,608
	20	60	30	191	26	VV2060MLL	\$2,370	\$2,608
	20	54	30	180	23	VV2054MLR	\$2,322	\$2,555
	20	54	30	180	23	VV2054MLL	\$2,322	\$2,555
	20	48	30	167	21	VV2048MLR	\$2,246	\$2,471
	20	48	30	167	21	VV2048MLL	\$2,246	\$2,471

- top edge profile on user side
- short grain direction
- one end and back panel grommet with wire pass thru
- one surface grommet
- 30" width multi-file
- pedestal front locking
- optional 10" modesty panel available in place of full modesty, specify 10" modesty on order

VISION - VENEER

Description	D	W	H	CTN WT	CU FT	① Model	Flat Cut List Price	Double Cut List Price
Shell Return	24	72	30	153	36	VW2472RSHR	\$1,323	\$1,456
<b>NOW!</b>	24	72	30	153	36	VW2472LSHR	\$1,323	\$1,456
	24	66	30	147	33	VW2466RSHR	\$1,232	\$1,356
	24	66	30	147	33	VW2466LSHR	\$1,232	\$1,356
	24	60	30	141	30	VW2460RSHR	\$1,195	\$1,315
	24	60	30	141	30	VW2460LSHR	\$1,195	\$1,315
	24	54	30	136	27	VW2454RSHR	\$1,160	\$1,276
	24	54	30	136	27	VW2454LSHR	\$1,160	\$1,276
	24	48	30	130	25	VW2448RSHR	\$1,125	\$1,238
	24	48	30	130	25	VW2448LSHR	\$1,125	\$1,238
	24	42	30	124	22	VW2442RSHR	\$1,091	\$1,201
	24	42	30	124	22	VW2442LSHR	\$1,091	\$1,201
24	36	30	120	19	VW2436RSHR	\$1,059	\$1,165	
24	36	30	120	19	VW2436LSHR	\$1,059	\$1,165	
20	72	30	142	31	VW2072RSHR	\$1,272	\$1,400	
20	72	30	142	31	VW2072LSHR	\$1,272	\$1,400	
20	66	30	138	28	VW2066RSHR	\$1,183	\$1,301	
20	66	30	138	28	VW2066LSHR	\$1,183	\$1,301	
20	60	30	135	26	VW2060RSHR	\$1,147	\$1,263	
20	60	30	135	26	VW2060LSHR	\$1,147	\$1,263	
20	54	30	129	23	VW2054RSHR	\$1,113	\$1,225	
20	54	30	129	23	VW2054LSHR	\$1,113	\$1,225	
20	48	30	125	21	VW2048RSHR	\$1,080	\$1,188	
20	48	30	125	21	VW2048LSHR	\$1,080	\$1,188	
20	42	30	119	18	VW2042RSHR	\$1,048	\$1,153	
20	42	30	119	18	VW2042LSHR	\$1,048	\$1,153	
20	36	30	115	16	VW2036RSHR	\$1,017	\$1,119	
20	36	30	115	16	VW2036LSHR	\$1,017	\$1,119	

- top edge profile on user side
  - short grain direction
  - one end and back panel grommet
  - one surface grommet
  - shell units are not designed to accept modular pedestals from pages 287 and 288 ▲
  - optional 10" modesty panel available in place of full modesty, specify 10" modesty on order ▲
- Note: Long grain direction for 66" and 72" wide HPL laminate worksurfaces

**To Order, Specify:**

- ① Model Number
- ② Wood Species - Cherry (CH1), Maple (MA1), Walnut (WA1) or Double Cut (see page 228)
- ③ Finish Color (see page 229)
- ④ Edge Profile (see page 233)
- ⑤ Pull Style and Color (see page 233)
- ⑥ Grommet Color - Matte Black (MBK) or Stardust Silver (STS) (see page 234)
- ⑦ Other Product Options (see page 229)
- ⑧ Accessories (see page 407)
- ⑨ Power and Data Options (see page 407)

When ordering Quickship products, place a "Q" in front of model number.  
Example: QV3072DD

**NOW!**  
Need it.  
JSI Quickship

VISION - VENEER

Description	D	W	H	CTN WT	CU FT	① Model	Flat Cut List Price	Double Cut List Price
Cockpit Shell Return	24	66	30	153	36	VV2466RCSHR	\$1,556	\$1,712
Cockpit Shell Return	24	66	30	153	36	VV2466LCSHR	\$1,556	\$1,712
 left shown	24	60	30	147	33	VV2460RCSHR	\$1,464	\$1,611
	24	60	30	147	33	VV2460LCSHR	\$1,464	\$1,611
	24	54	30	147	33	VV2454RCSHR	\$1,412	\$1,553
	24	54	30	147	33	VV2454LCSHR	\$1,412	\$1,553

· top edge profile on user side  
 · short grain direction  
 · one end and back panel grommet  
 · one surface grommet  
 · shell units are not designed to accept modular pedestals from pages 287 and 288 ▲  
 Note: Long grain direction for 66" wide HPL laminate worksurfaces

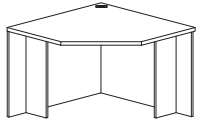
Description	D	W	H	CTN WT	CU FT	① Model	Flat Cut List Price	Double Cut List Price
Bullet Return	60	30	1 3/16	91	4	VV3060BRET	\$837	\$921
Bullet Return	48	30	1 3/16	68	4	VV3048BRET	\$744	\$818
 grain	60	24	1 3/16	70	3	VV2460BRET	\$720	\$792
	48	24	1 3/16	55	3	VV2448BRET	\$636	\$700

· edge profile on three open sides  
 · short grain direction ▲  
 · includes hardware to attach flat end to desk top  
 · base must be purchased separately, see below

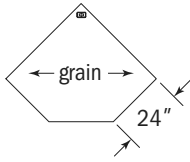
### Bases for Bullet Return

  <b>Column Base</b> · 04BB - Black Sandtex - \$321 · 04SB - Stardust Silver - \$321  <b>Base:</b> · 13 gauge steel · 4" diameter	 <b>Column Disk Base</b> · 12DB - Black Sandtex - \$385 · 12DS - Stardust Silver - \$385  <b>Base:</b> · support disk: 11" diameter	 <b>H Base</b> use with 36" or 48" deep tops · 24HB - Black Sandtex - \$354 · 24HS - Stardust Silver - \$354  use with 30" deep tops · 18HB - Black Sandtex - \$333 · 18HS - Stardust Silver - \$333	 <b>U Base</b> use with 36" or 48" deep tops · 24UB - Black Sandtex - \$354 · 24US - Stardust Silver - \$354  use with 30" deep tops · 18UB - Black Sandtex - \$333 · 18US - Stardust Silver - \$333
---	---	--	--

Description	D	W	H	CTN WT	CU FT	① Model	Flat Cut List Price	Double Cut List Price
<b>Corner Unit</b>	42	42	30	162	36	<b>VW4242-24ECU</b>	\$1,829	\$2,012
<b>NOW!</b>	36	36	30	132	27	<b>VW3636-24ECU</b>	\$1,776	\$1,955



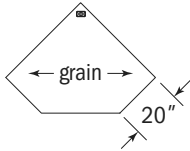
- angle grain on top
- top edge profile on user side
- two end panel grommets
- one surface grommet



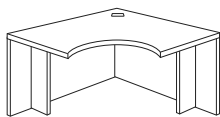
<b>Corner Unit</b>	42	42	30	162	36	<b>VW4242-20ECU</b>	\$1,829	\$2,012
<b>NOW!</b>	36	36	30	132	27	<b>VW3636-20ECU</b>	\$1,776	\$1,955



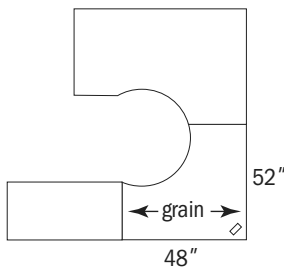
- angle grain on top
- top edge profile on user side
- two end panel grommets
- one surface grommet



<b>Cockpit Corner Unit</b>	48	52	30	180	50	<b>VW4852ERCU</b>	\$1,950	\$2,146
<b>NOW!</b>	48	52	30	180	50	<b>VW4852ELCU</b>	\$1,950	\$2,146



- parallel grain to 48" side of top
- top edge profile on user side
- two end panel grommets
- one surface grommet
- attaches to 24" return



right shown

**To Order, Specify:**

- ① Model Number
- ② Wood Species - Cherry (CH1), Maple (MA1), Walnut (WA1) or Double Cut (see page 228)
- ③ Finish Color (see page 229)
- ④ Edge Profile (see page 233)
- ⑤ Grommet Color - Matte Black (MBK) or Stardust Silver (STS) (see page 234)
- ⑥ Other Product Options (see page 229)
- ⑦ Accessories (see page 407)
- ⑧ Power and Data Options (see page 407)

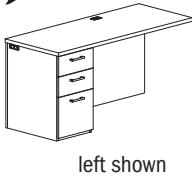

When ordering Quickship products, place a "Q" in front of model number.  
Example: QVW3072DD

**NOW!**  
Need it.  
JSI Quickship



Description	D	W	H	CTN WT	CU FT	① Model	Flat Cut List Price	Double Cut List Price
File/File Corner Return	24	60	30	190	30	VV2460ERCR	\$1,855	\$2,041
 <p>left shown</p> 	24	60	30	190	30	VV2460ELCR	\$1,855	\$2,041
	24	54	30	179	27	VV2454ERCR	\$1,804	\$1,985
	24	54	30	179	27	VV2454ELCR	\$1,804	\$1,985
	24	48	30	168	25	VV2448ERCR	\$1,725	\$1,898
	24	48	30	168	25	VV2448ELCR	\$1,725	\$1,898
	24	42	30	155	22	VV2442ERCR	\$1,675	\$1,843
	24	42	30	155	22	VV2442ELCR	\$1,675	\$1,843
	20	60	30	173	26	VV2060ERCR	\$1,781	\$1,960
	20	60	30	173	26	VV2060ELCR	\$1,781	\$1,960
	20	54	30	163	23	VV2054ERCR	\$1,733	\$1,906
20	54	30	163	23	VV2054ELCR	\$1,733	\$1,906	
20	48	30	154	21	VV2048ERCR	\$1,656	\$1,822	
20	48	30	154	21	VV2048ELCR	\$1,656	\$1,822	
20	42	30	142	18	VV2042ERCR	\$1,609	\$1,771	
20	42	30	142	18	VV2042ELCR	\$1,609	\$1,771	

- top edge profile on user side
- long grain direction
- one end and back panel grommet with wire pass thru
- one surface grommet
- letter width file/file pedestal
- pedestal front locking
- optional 10" modesty panel available in place of full modesty, specify 10" modesty on order

Description	D	W	H	CTN WT	CU FT	① Model	Flat Cut List Price	Double Cut List Price
Box/Box/File Corner Return	24	60	30	190	30	VW2460ERCY	\$1,855	\$2,041
<b>NOW!</b>	24	60	30	190	30	VW2460ELCY	\$1,855	\$2,041
	24	54	30	179	27	VW2454ERCY	\$1,804	\$1,985
left shown	24	54	30	179	27	VW2454ELCY	\$1,804	\$1,985
	24	48	30	168	25	VW2448ERCY	\$1,725	\$1,898
	24	48	30	168	25	VW2448ELCY	\$1,725	\$1,898
	24	42	30	155	22	VW2442ERCY	\$1,675	\$1,843
	24	42	30	155	22	VW2442ELCY	\$1,675	\$1,843
	20	60	30	173	26	VW2060ERCY	\$1,781	\$1,960
	20	60	30	173	26	VW2060ELCY	\$1,781	\$1,960
	20	54	30	163	23	VW2054ERCY	\$1,733	\$1,906
	20	54	30	163	23	VW2054ELCY	\$1,733	\$1,906
	20	48	30	154	21	VW2048ERCY	\$1,656	\$1,822
	20	48	30	154	21	VW2048ELCY	\$1,656	\$1,822
	20	42	30	142	18	VW2042ERCY	\$1,609	\$1,771
	20	42	30	142	18	VW2042ELCY	\$1,609	\$1,771


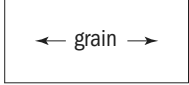
- top edge profile on user side
- long grain direction
- one end and back panel grommet with wire pass thru
- one surface grommet
- letter width box/box/file pedestal
- pedestal front locking
- optional 10" modesty panel available in place of full modesty, specify 10" modesty on order

**To Order, Specify:**


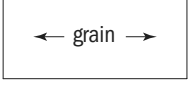
- ① Model Number
- ② Wood Species - Cherry (CH1), Maple (MA1), Walnut (WA1) or Double Cut (see page 228)
- ③ Finish Color (see page 229)
- ④ Edge Profile (see page 233)
- ⑤ Pull Style and Color (see page 233)
- ⑥ Grommet Color - Matte Black (MBK) or Stardust Silver (STS) (see page 234)
- ⑦ Other Product Options (see page 229)
- ⑧ Accessories (see page 407)
- ⑨ Power and Data Options (see page 407)

When ordering Quickship products, place a "Q" in front of model number.  
Example: QV3072DD

**NOW!**  
Need it.  
JSI Quickship


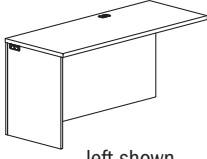
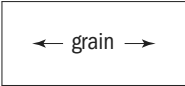
Description	D	W	H	CTN WT	CU FT	① Model	Flat Cut List Price	Double Cut List Price
<b>Lateral File Corner Return</b>  left shown 	24	60	30	199	30	VV2460LRCR	\$2,103	\$2,314
	24	60	30	199	30	VV2460LLCR	\$2,103	\$2,314
	24	54	30	187	27	VV2454LRCR	\$2,024	\$2,226
	24	54	30	187	27	VV2454LLCR	\$2,024	\$2,226
	24	48	30	175	25	VV2448LRCR	\$1,973	\$2,171
	24	48	30	175	25	VV2448LLCR	\$1,973	\$2,171
	20	60	30	188	26	VV2060LRCR	\$2,019	\$2,221
	20	60	30	188	26	VV2060LLCR	\$2,019	\$2,221
	20	54	30	177	23	VV2054LRCR	\$1,943	\$2,137
	20	54	30	177	23	VV2054LLCR	\$1,943	\$2,137
	20	48	30	164	21	VV2048LRCR	\$1,896	\$2,086
	20	48	30	164	21	VV2048LLCR	\$1,896	\$2,086

- top edge profile on user side
- long grain direction
- one end and back panel grommet with wire pass thru
- one surface grommet
- 36" width lateral file
- pedestal front locking
- optional 10" modesty panel available in place of full modesty, specify 10" modesty on order

<b>Multi-File Corner Return</b>  left shown 	24	60	30	202	30	VV2460MRCR	\$2,469	\$2,717
	24	60	30	202	30	VV2460MLCR	\$2,469	\$2,717
	24	54	30	190	27	VV2454MRCR	\$2,419	\$2,661
	24	54	30	190	27	VV2454MLCR	\$2,419	\$2,661
	24	48	30	179	25	VV2448MRCR	\$2,339	\$2,573
	24	48	30	179	25	VV2448MLCR	\$2,339	\$2,573
	20	60	30	191	26	VV2060MRCR	\$2,370	\$2,608
	20	60	30	191	26	VV2060MLCR	\$2,370	\$2,608
	20	54	30	180	23	VV2054MRCR	\$2,322	\$2,555
	20	54	30	180	23	VV2054MLCR	\$2,322	\$2,555
	20	48	30	167	21	VV2048MRCR	\$2,246	\$2,471
	20	48	30	167	21	VV2048MLCR	\$2,246	\$2,471

- top edge profile on user side
- long grain direction
- one end and back panel grommet with wire pass thru
- one surface grommet
- 30" width multi-file
- pedestal front locking
- optional 10" modesty panel available in place of full modesty, specify 10" modesty on order

VISION - VENEER

Description	D	W	H	CTN WT	CU FT	① Model	Flat Cut List Price	Double Cut List Price
Shell Corner Return	24	72	30	153	36	VW2472RSHCR	\$1,323	\$1,456
	24	72	30	153	36	VW2472LSHCR	\$1,323	\$1,456
	24	66	30	147	33	VW2466RSHCR	\$1,232	\$1,356
left shown	24	66	30	147	33	VW2466LSHCR	\$1,232	\$1,356
	24	60	30	141	30	VW2460RSHCR	\$1,195	\$1,315
	24	60	30	141	30	VW2460LSHCR	\$1,195	\$1,315
	24	54	30	136	27	VW2454RSHCR	\$1,160	\$1,276
	24	54	30	136	27	VW2454LSHCR	\$1,160	\$1,276
	24	48	30	130	25	VW2448RSHCR	\$1,125	\$1,238
	24	48	30	130	25	VW2448LSHCR	\$1,125	\$1,238
	24	42	30	124	22	VW2442RSHCR	\$1,091	\$1,201
	24	42	30	124	22	VW2442LSHCR	\$1,091	\$1,201
	24	36	30	120	19	VW2436RSHCR	\$1,059	\$1,165
	24	36	30	120	19	VW2436LSHCR	\$1,059	\$1,165
	20	72	30	142	31	VW2072RSHCR	\$1,272	\$1,400
	20	72	30	142	31	VW2072LSHCR	\$1,272	\$1,400
	20	66	30	138	28	VW2066RSHCR	\$1,183	\$1,301
	20	66	30	138	28	VW2066LSHCR	\$1,183	\$1,301
	20	60	30	135	26	VW2060RSHCR	\$1,147	\$1,263
	20	60	30	135	26	VW2060LSHCR	\$1,147	\$1,263
	20	54	30	129	23	VW2054RSHCR	\$1,113	\$1,225
	20	54	30	129	23	VW2054LSHCR	\$1,113	\$1,225
	20	48	30	125	21	VW2048RSHCR	\$1,080	\$1,188
	20	48	30	125	21	VW2048LSHCR	\$1,080	\$1,188
	20	42	30	119	18	VW2042RSHCR	\$1,048	\$1,153
	20	42	30	119	18	VW2042LSHCR	\$1,048	\$1,153
	20	36	30	115	16	VW2036RSHCR	\$1,017	\$1,119
	20	36	30	115	16	VW2036LSHCR	\$1,017	\$1,119

- top edge profile on user side
- long grain direction
- one end and back panel grommet with wire pass thru
- one surface grommet
- optional 10" modesty panel available in place of full modesty, specify 10" modesty on order
- shell units are not designed to accept modular pedestals from pages 287 and 288 ▲


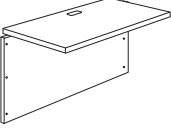
**To Order, Specify:**

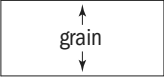
- ① Model Number
- ② Wood Species - Cherry (CH1), Maple (MA1), Walnut (WA1) or Double Cut (see page 228)
- ③ Finish Color (see page 229)
- ④ Edge Profile (see page 233)
- ⑤ Pull Style and Color (see page 233)
- ⑥ Grommet Color - Matte Black (MBK) or Stardust Silver (STS) (see page 234)
- ⑦ Other Product Options (see page 229)
- ⑧ Accessories (see page 407)
- ⑨ Power and Data Options (see page 407)

When ordering Quickship products, place a "Q" in front of model number.  
Example: QV3072DD

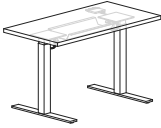

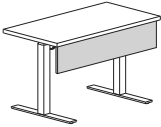
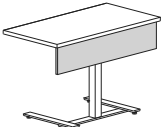
**NOW!**  
Need it.  
JSI Quickship

VISION - VENEER

Description	D	W	H	CTN WT	CU FT	① Model	Flat Cut List Price	Double Cut List Price
Bridge with Modesty Panel	24	48	30	112	4	VV2448EB	\$563	\$620
 	24	42	30	109	3	VV2442EB	\$538	\$593
	24	36	30	101	3	VV2436EB	\$524	\$577
	20	48	30	104	4	VV2048EB	\$541	\$596
	20	42	30	102	3	VV2042EB	\$518	\$571
	20	36	30	96	3	VV2036EB	\$503	\$554



- top edge profile on user side
- short grain direction
- one back panel grommet
- one surface grommet

Description	D	W	H	CTN WT	CU FT	① Model	Flat Cut List Price	Double Cut List Price
<b>Electric Adjustable Height Bridge</b>	24	46	Adj.	90	9	VW2446AHB-EL	\$3,156	\$3,472
	24	40	Adj.	85	8	VW2440AHB-EL	\$3,117	\$3,429
	<ul style="list-style-type: none"> <li>• 27 1/2" to 44 1/2" height adjustment</li> <li>• top edge profile on user and approach sides</li> <li>• push button control pad mounted right or left</li> <li>• key pad features height display with four memory settings</li> <li>• 72" power cord</li> <li>• 225 lb. max load</li> <li>• specify Black Sandtex (BSX) or Stardust Silver (STS) base finish</li> <li>• ships KD</li> </ul>							
<b>Pneumatic Adjustable Height Bridge</b>	24	46	Adj.	90	9	VW2446AHB-PN	\$2,570	\$2,827
	24	40	Adj.	85	8	VW2440AHB-PN	\$2,507	\$2,758
	<ul style="list-style-type: none"> <li>• 27 1/2" to 44 1/2" height adjustment</li> <li>• top edge profile on user and approach sides</li> <li>• release lever mounts under edge of top</li> <li>• may be used in place of standard bridge</li> <li>• 1" gap between credenza or desk top avoids pinch point</li> <li>• can be used as freestanding table</li> <li>• 180 lb. max load</li> <li>• specify Matte Black or Alloy base finish</li> <li>• ships KD</li> </ul>							
<b>Modesty Panel for Adjustable Height Bridge</b>	3/4	46	9	13	2	VW0946TDM	\$497	\$548
	3/4	40	9	11	2	VW0940TDM	\$482	\$531
 	<ul style="list-style-type: none"> <li>• VW0946TDM use with 46" wide adjustable height bridge</li> <li>• VW0940TDM use with 40" wide adjustable height bridge</li> <li>• flat edge detail</li> <li>• modesty panel bracket is available in Black Sandtex (BSX) or Stardust Silver (STS)</li> </ul>							


VISION - VENEER

**To Order, Specify:**


- ① Model Number
- ② Wood Species - Cherry (CH1), Maple (MA1), Walnut (WA1) or Double Cut (see page 228)
- ③ Finish Color (see page 229)
- ④ Edge Profile (see page 233)
- ⑤ Metal Color (see page 237)
- ⑥ Grommet Color - Matte Black (MBK) or Stardust Silver (STS) (see page 234)
- ⑦ Other Product Options (see page 229)
- ⑧ Accessories (see page 407)
- ⑨ Power and Data Options (see page 407)

When ordering Quickship products, place a "Q" in front of model number.  
Example: QV3072DD



Description	D	W	H	CTN WT	CU FT	① Model	Flat Cut List Price	Double Cut List Price
<b>Storage Credenza</b> 	24	72	30	309	36	VV2472SC	\$2,823	\$3,105
	24	66	30	285	33	VV2466SC	\$2,631	\$2,894
	20	72	30	284	31	VV2072SC	\$2,711	\$2,982
	20	66	30	255	28	VV2066SC	\$2,527	\$2,780

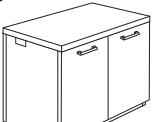
- file/file pedestals - letter width
- top edge profile on user side
- two end panel grommets with wire pass thru
- adjustable shelf in storage cabinet
- pedestal front locking
- locking doors available, specify and add \$105 list

<b>Lateral File Credenza</b> 	24	72	30	248	39	VV2472LFC	\$3,027	\$3,330
	24	60	30	243	30	VV2460LFC	\$2,981	\$3,280
	20	72	30	223	36	VV2072LFC	\$2,907	\$3,198
	20	60	30	220	26	VV2060LFC	\$2,863	\$3,149

- two drawer lateral files side by side
- top edge profile on user side
- two end panel grommets with wire pass thru
- pedestal front locking

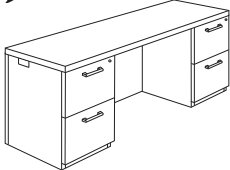
<b>Four Door Credenza</b> 	24	72	30	293	36	VV2472DSC	\$2,734	\$3,008
	24	60	30	287	30	VV2460DSC	\$2,507	\$2,758
	20	72	30	268	36	VV2072DSC	\$2,624	\$2,887
	20	60	30	266	26	VV2060DSC	\$2,407	\$2,649

- top edge profile on user side
- two end panel grommets with wire pass thru
- adjustable shelf in storage cabinets
- locking doors available, specify and add \$210 list


<b>Two Door Credenza</b> 	24	36	30	133	19	VV2436SC	\$1,325	\$1,458
	24	30	30	129	16	VV2430SC	\$1,313	\$1,444
	20	36	30	121	16	VV2036SC	\$1,273	\$1,401
	20	30	30	119	14	VV2030SC	\$1,260	\$1,386

- top edge profile on user side
- two end panel grommets with wire pass thru
- one adjustable shelf
- locking doors available, specify and add \$105 list


VISION - VENEER

Description	D	W	H	CTN WT	CU FT	① Model	Flat Cut List Price	Double Cut List Price
<b>Kneespace Credenza</b> 	24	84	30	299	42	VW2484KC	\$2,811	\$3,093
	24	78	30	280	39	VW2478KC	\$2,738	\$3,012
	24	72	30	261	36	VW2472KC	\$2,661	\$2,928
	24	66	30	243	33	VW2466KC	\$2,455	\$2,701
	24	60	30	231	30	VW2460KC	\$2,394	\$2,634
	20	84	30	270	36	VW2084KC	\$2,700	\$2,971
	20	78	30	253	33	VW2078KC	\$2,629	\$2,892
	20	72	30	236	31	VW2072KC	\$2,555	\$2,811
	20	66	30	220	28	VW2066KC	\$2,358	\$2,594
	20	60	30	210	26	VW2060KC	\$2,299	\$2,529

- file/file pedestals - letter width
- top edge profile on user side
- one back and two end panel grommets with wire pass thru
- pedestal front locking
- kneespace for VW2484KC and VW2084KC - 52 5/8"
- kneespace for VW2478KC and VW2078KC - 46 5/8"
- kneespace for VW2472KC and VW2072KC - 40 5/8"
- kneespace for VW2466KC and VW2066KC - 34 5/8"
- kneespace for VW2460KC and VW2060KC - 28 5/8"
- optional 10" modesty panel available in place of full modesty, specify 10" modesty on order

<b>Buffet Credenza</b> 	24	72	36	316	43	VW2472BSC	\$3,649	\$4,015
	20	72	36	291	31	VW2072BSC	\$3,504	\$3,855

- four door credenza
- four box drawers above doors
- top edge profile on user side
- two end panel grommets with wire pass thru
- adjustable shelf in storage cabinets
- locking doors and drawers not available

<b>Buffet Credenza</b> 	24	36	36	167	22	VW2436BSC	\$2,615	\$2,876
	20	36	36	155	16	VW2036BSC	\$2,511	\$2,763

- two door credenza
- two box drawers above doors
- top edge profile on user side
- two end panel grommets with wire pass thru
- adjustable shelf in storage cabinet
- locking doors and drawers not available

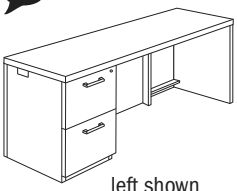
**To Order, Specify:**

- ① Model Number
- ② Wood Species - Cherry (CH1), Maple (MA1), Walnut (WA1) or Double Cut (see page 228)
- ③ Finish Color (see page 229)
- ④ Edge Profile (see page 233)
- ⑤ Pull Style and Color (see page 233)
- ⑥ Grommet Color - Matte Black (MBK) or Stardust Silver (STS) (see page 234)
- ⑦ Other Product Options (see page 229)
- ⑧ Accessories (see page 407)
- ⑨ Power and Data Options (see page 407)

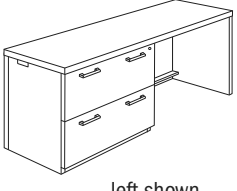
When ordering Quickship products, place a "Q" in front of model number.  
 Example: QVW3072DD

**NOW!**  
*Need it.*  
 JSI Quickship



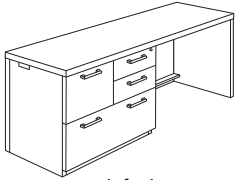
Description	D	W	H	CTN WT	CU FT	① Model	Flat Cut List Price	Double Cut List Price
<b>File/File Pedestal Credenza</b>  left shown	24	84	30	248	42	VV2484RC	\$2,120	\$2,333
	24	84	30	248	42	VV2484LC	\$2,120	\$2,333
	24	78	30	237	39	VV2478RC	\$2,039	\$2,243
	24	78	30	237	39	VV2478LC	\$2,039	\$2,243
	24	72	30	226	36	VV2472RC	\$1,960	\$2,156
	24	72	30	226	36	VV2472LC	\$1,960	\$2,156
	24	66	30	212	33	VV2466RC	\$1,906	\$2,097
	24	66	30	212	33	VV2466LC	\$1,906	\$2,097
	24	60	30	179	30	VV2460RC	\$1,880	\$2,068
	24	60	30	179	30	VV2460LC	\$1,880	\$2,068
	20	84	30	238	36	VV2084RC	\$2,036	\$2,240
	20	84	30	238	36	VV2084LC	\$2,036	\$2,240
	20	78	30	227	33	VV2078RC	\$1,958	\$2,154
	20	78	30	227	33	VV2078LC	\$1,958	\$2,154
	20	72	30	216	31	VV2072RC	\$1,882	\$2,071
	20	72	30	216	31	VV2072LC	\$1,882	\$2,071
	20	66	30	203	28	VV2066RC	\$1,831	\$2,014
	20	66	30	203	28	VV2066LC	\$1,831	\$2,014
	20	60	30	171	26	VV2060RC	\$1,805	\$1,986
	20	60	30	171	26	VV2060LC	\$1,805	\$1,986

- top edge profile on user side
- one back panel grommet and two end panel grommets with wire pass thru
- letter width pedestal
- pedestal front locking
- optional 10" modesty panel available in place of full modesty, specify 10" modesty on order

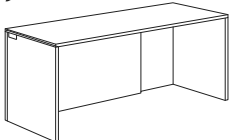
Description	D	W	H	CTN WT	CU FT	① Model	Flat Cut List Price	Double Cut List Price
<b>Lateral File Pedestal Credenza</b>  left shown	24	84	30	256	42	VV2484LRC	\$2,396	\$2,636
	24	84	30	256	42	VV2484LLC	\$2,396	\$2,636
	24	78	30	244	39	VV2478LRC	\$2,302	\$2,533
	24	78	30	244	39	VV2478LLC	\$2,302	\$2,533
	24	72	30	232	36	VV2472LRC	\$2,214	\$2,435
	24	72	30	232	36	VV2472LLC	\$2,214	\$2,435
	20	84	30	245	36	VV2084LRC	\$2,300	\$2,530
	20	84	30	245	36	VV2084LLC	\$2,300	\$2,530
	20	78	30	233	33	VV2078LRC	\$2,211	\$2,432
	20	78	30	233	33	VV2078LLC	\$2,211	\$2,432
	20	72	30	221	31	VV2072LRC	\$2,126	\$2,339
	20	72	30	221	31	VV2072LLC	\$2,126	\$2,339

- top edge profile on user side
- one back panel grommet and two end panel grommets with wire pass thru
- 36" width lateral file
- pedestal front locking
- optional 10" modesty panel available in place of full modesty, specify 10" modesty on order

VISION - VENEER

Description	D	W	H	CTN WT	CU FT	① Model	Flat Cut List Price	Double Cut List Price
<b>Multi-File Pedestal Credenza</b>  left shown	24	84	30	260	42	VV2484MRC	\$2,792	\$3,072
	24	84	30	260	42	VV2484MLC	\$2,792	\$3,072
	24	78	30	248	39	VV2478MRC	\$2,684	\$2,953
	24	78	30	248	39	VV2478MLC	\$2,684	\$2,953
	24	72	30	235	36	VV2472MRC	\$2,580	\$2,839
	24	72	30	235	36	VV2472MLC	\$2,580	\$2,839
	20	84	30	249	36	VV2084MRC	\$2,681	\$2,950
	20	84	30	249	36	VV2084MLC	\$2,681	\$2,950
	20	78	30	237	33	VV2078MRC	\$2,577	\$2,835
	20	78	30	237	33	VV2078MLC	\$2,577	\$2,835
	20	72	30	225	31	VV2072MRC	\$2,477	\$2,725
	20	72	30	225	31	VV2072MLC	\$2,477	\$2,725

- top edge profile on user side
- one back panel grommet and two end panel grommets with wire pass thru
- 30" width multi-file
- pedestal front locking
- optional 10" modesty panel available in place of full modesty, specify 10" modesty on order

<b>Shell Credenza</b> 	24	72	30	159	36	VV2472SHD	\$1,512	\$1,664
	24	66	30	153	33	VV2466SHD	\$1,425	\$1,568

- top edge profile on user side
- one back panel grommet and two end panel grommets
- shell units are not designed to accept modular pedestals from pages 287 and 288 ▲

**To Order, Specify:**

- ① Model Number
- ② Wood Species - Cherry (CH1), Maple (MA1), Walnut (WA1) or Double Cut (see page 228)
- ③ Finish Color (see page 229)
- ④ Edge Profile (see page 233)
- ⑤ Pull Style and Color (see page 233)
- ⑥ Grommet Color - Matte Black (MBK) or Stardust Silver (STS) (see page 234)
- ⑦ Other Product Options (see page 229)
- ⑧ Accessories (see page 407)
- ⑨ Power and Data Options (see page 407)

When ordering Quickship products, place a "Q" in front of model number.  
 Example: QVV3072DD

**NOW!**  
*Need it.*  
 JSI Quickship

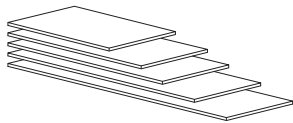
**Modular**

Description	D	W	H	CTN WT	CU FT	① Model	Flat Cut List Price	Double Cut List Price
Modular Bow Front Desk Top	42	72	1 3/16	130	12	VV4272BMCT	\$1,720	\$1,893
<b>NOW!</b>	36	72	1 3/16	110	9	VV3672BMCT	\$1,588	\$1,748

- top edge profile on user and approach sides
- long grain direction



Modular Rectangular Desk Top	36	72	1 3/16	117	9	VV3672MCT	\$1,097	\$1,207
<b>NOW!</b>	36	66	1 3/16	108	9	VV3666MCT	\$1,005	\$1,106
	30	72	1 3/16	98	8	VV3072MCT	\$914	\$1,005
	30	66	1 3/16	90	7	VV3066MCT	\$838	\$922
	30	60	1 3/16	82	7	VV3060MCT	\$762	\$838
	30	54	1 3/16	74	6	VV3054MCT	\$686	\$755
	30	48	1 3/16	65	5	VV3048MCT	\$609	\$670
	30	42	1 3/16	57	4	VV3042MCT	\$534	\$587

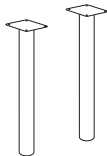


- top edge profile on user and approach sides
- long grain direction

VISION - VENEER

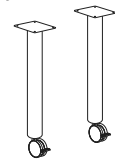
							List Price
Metal Legs	2	2	28	12	1	VS28LEG2	\$269

- NOW!**
- set of two legs
  - 2" diameter column
  - 6" square mounting plate
  - wood screws included for attachment to top
  - specify Black Sandtex (BSX) or Stardust Silver (STS) base finish

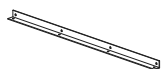


Metal Legs with Casters	2	2	28	12	1	VS28LEGC2	\$280
-------------------------	---	---	----	----	---	-----------	-------

- NOW!**
- set of two legs
  - 2" diameter column
  - 6" square mounting plate
  - wood screws included for attachment to top
  - specify Black Sandtex (BSX) or Stardust Silver (STS) base finish
  - black nylon locking casters


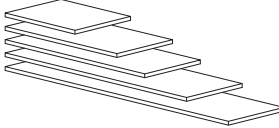


L-Bracket	1	27	1	4	1	VS-LBRKT-30	\$74
<b>NOW!</b>	1	21	1	4	1	VS-LBRKT-24	\$69
	1	17	1	3	1	VS-LBRKT-20	\$65



- attach to tall storage or wall
- matte black
- VS-LBRKT-30 typically used with 30" deep tops
- VS-LBRKT-24 typically used with 24" deep tops
- VS-LBRKT-20 typically used with 20" deep tops

Modular

Description	D	W	H	CTN WT	CU FT	① Model	Flat Cut List Price	Double Cut List Price
Modular Credenza Top	24	108	1 3/16	117	10	VV24108MCT	\$1,059	\$1,165
	24	102	1 3/16	111	10	VV24102MCT	\$1,001	\$1,102
	24	96	1 3/16	104	9	VV2496MCT	\$942	\$1,037
	24	90	1 3/16	98	9	VV2490MCT	\$848	\$933
	24	84	1 3/16	91	8	VV2484MCT	\$784	\$863
	24	78	1 3/16	85	8	VV2478MCT	\$741	\$815
	24	72	1 3/16	78	7	VV2472MCT	\$664	\$731
	24	66	1 3/16	72	7	VV2466MCT	\$634	\$698
	24	60	1 3/16	65	6	VV2460MCT	\$577	\$635
	24	54	1 3/16	59	6	VV2454MCT	\$567	\$624
	24	48	1 3/16	52	5	VV2448MCT	\$460	\$507
	24	42	1 3/16	46	4	VV2442MCT	\$395	\$435
	24	36	1 3/16	39	4	VV2436MCT	\$393	\$433
	24	30	1 3/16	33	3	VV2430MCT	\$361	\$397
	20	108	1 3/16	98	9	VV20108MCT	\$1,006	\$1,107
	20	102	1 3/16	93	8	VV20102MCT	\$952	\$1,047
	20	96	1 3/16	87	8	VV2096MCT	\$896	\$986
	20	90	1 3/16	82	8	VV2090MCT	\$806	\$887
	20	84	1 3/16	76	7	VV2084MCT	\$745	\$819
	20	78	1 3/16	71	7	VV2078MCT	\$704	\$774
	20	72	1 3/16	65	6	VV2072MCT	\$632	\$696
	20	66	1 3/16	60	6	VV2066MCT	\$602	\$663
	20	60	1 3/16	55	5	VV2060MCT	\$549	\$604
	20	54	1 3/16	49	5	VV2054MCT	\$539	\$594
	20	48	1 3/16	44	4	VV2048MCT	\$438	\$482
	20	42	1 3/16	38	4	VV2042MCT	\$376	\$414
	20	36	1 3/16	33	3	VV2036MCT	\$374	\$412
	20	30	1 3/16	28	3	VV2030MCT	\$343	\$377

- top edge profile on user side
- long grain direction

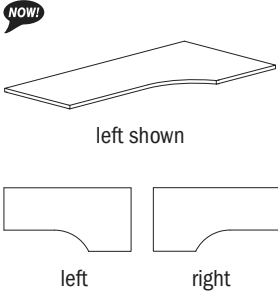
To Order, Specify:

- ① Model Number
- ② Wood Species - Cherry (CH1), Maple (MA1), Walnut (WA1) or Double Cut (see page 228)
- ③ Finish Color (see page 229)
- ④ Edge Profile (see page 233)
- ⑤ Metal Color (see page 237)

When ordering Quickship products, place a "Q" in front of model number.  
Example: QVV3072DD



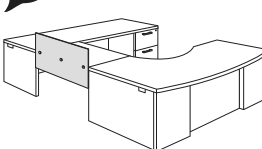
**Modular**

Description	D	W	H	CTN WT	CU FT	① Model	Flat Cut List Price	Double Cut List Price
<b>Modular Extended Corner Credenza Top</b>   <p>left shown</p> <p>left right</p>	36	96	1 3/16	117	13	VV3696MCCT24R	\$1,563	\$1,719
	36	96	1 3/16	117	13	VV3696MCCT24L	\$1,563	\$1,719
	36	90	1 3/16	111	13	VV3690MCCT24R	\$1,512	\$1,664
	36	90	1 3/16	111	13	VV3690MCCT24L	\$1,512	\$1,664
	36	84	1 3/16	104	12	VV3684MCCT24R	\$1,478	\$1,626
	36	84	1 3/16	104	12	VV3684MCCT24L	\$1,478	\$1,626
	36	72	1 3/16	91	10	VV3672MCCT24R	\$1,172	\$1,290
	36	72	1 3/16	91	10	VV3672MCCT24L	\$1,172	\$1,290
	36	66	1 3/16	85	9	VV3666MCCT24R	\$1,127	\$1,241
	36	66	1 3/16	85	9	VV3666MCCT24L	\$1,127	\$1,241
	36	60	1 3/16	78	9	VV3660MCCT24R	\$1,071	\$1,179
	36	60	1 3/16	78	9	VV3660MCCT24L	\$1,071	\$1,179
	36	54	1 3/16	71	8	VV3654MCCT24R	\$1,021	\$1,124
	36	54	1 3/16	71	8	VV3654MCCT24L	\$1,021	\$1,124

- top edge profile on user side
- long grain direction

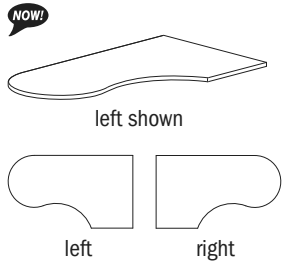
Description	D	W	H	CTN WT	CU FT	Model	List Price	List Price
<b>Modular Return/Bridge Top</b>  	24	60	1 3/16	65	6	VV6024MCT	\$671	\$739
	24	54	1 3/16	59	6	VV5424MCT	\$660	\$726
	24	48	1 3/16	52	5	VV4824MCT	\$554	\$609
	24	42	1 3/16	46	4	VV4224MCT	\$489	\$538
	24	36	1 3/16	39	4	VV3624MCT	\$487	\$536
	20	60	1 3/16	55	5	VV6020MCT	\$639	\$703
	20	54	1 3/16	49	5	VV5420MCT	\$627	\$690
	20	48	1 3/16	44	4	VV4820MCT	\$527	\$580
	20	42	1 3/16	38	4	VV4220MCT	\$465	\$512
	20	36	1 3/16	33	3	VV3620MCT	\$462	\$509

- top edge profile on user side
- short grain direction
- one surface grommet

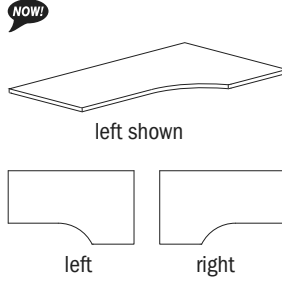
Description	D	W	H	CTN WT	CU FT	Model	List Price
<b>Bridge Panel Screen</b>  	1/4	48	20	8	2	VS2048FPS	\$490
	1/4	42	20	8	2	VS2042FPS	\$483
	1/4	36	20	7	2	VS2036FPS	\$479

- mounts to bridge top
- acrylic panel - frosted
- aluminum decorative mounting screws
- field installed

Modular

Description	D	W	H	CTN WT	CU FT	① Model	Flat Cut List Price	Double Cut List Price
Modular Extended Corner	48	72	1 3/16	130	13	VV4872MCBT24R	\$2,142	\$2,357
Bullet Desk Top	48	72	1 3/16	130	13	VV4872MCBT24L	\$2,142	\$2,357
	42	72	1 3/16	111	12	VV4272MCBT24R	\$1,875	\$2,063
	42	72	1 3/16	111	12	VV4272MCBT24L	\$1,875	\$2,063
	42	66	1 3/16	103	11	VV4266MCBT24R	\$1,719	\$1,892
	42	66	1 3/16	103	11	VV4266MCBT24L	\$1,719	\$1,892

- top edge profile on three open sides
- long grain direction
- supports located on pages 265, 286 and 288

Modular Extended Corner	48	72	1 3/16	130	13	VV4872MCDT24R	\$1,563	\$1,719
Desk Top	48	72	1 3/16	130	13	VV4872MCDT24L	\$1,563	\$1,719
	42	72	1 3/16	111	12	VV4272MCDT24R	\$1,368	\$1,505
	42	72	1 3/16	111	12	VV4272MCDT24L	\$1,368	\$1,505
	48	66	1 3/16	120	12	VV4866MCDT24R	\$1,502	\$1,652
	48	66	1 3/16	120	12	VV4866MCDT24L	\$1,502	\$1,652
	42	66	1 3/16	103	11	VV4266MCDT24R	\$1,315	\$1,447
	42	66	1 3/16	103	11	VV4266MCDT24L	\$1,315	\$1,447

- top edge profile on three open sides
- long grain direction
- supports located on pages 265, 286 and 288



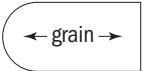
To Order, Specify:

- ① Model Number
- ② Wood Species - Cherry (CH1), Maple (MA1), Walnut (WA1) or Double Cut (see page 228)
- ③ Finish Color (see page 229)
- ④ Edge Profile (see page 233)
- ⑤ Grommet Color (see page 234)




When ordering Quickship products, place a "Q" in front of model number.  
Example: QVV3072DD

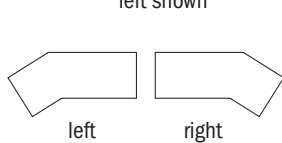
**NOW!**  
Need it.  
JSI Quickship

**Modular**

Description	D	W	H	CTN WT	CU FT	① Model	Flat Cut List Price	Double Cut List Price
Modular Bullet Desk Top	36	84	1 3/16	137	12	VV3684MBULT	\$1,720	\$1,893
 	36	78	1 3/16	127	11	VV3678MBULT	\$1,598	\$1,758
	36	72	1 3/16	117	10	VV3672MBULT	\$1,323	\$1,456
	30	72	1 3/16	98	9	VV3072MBULT	\$1,166	\$1,283
	30	66	1 3/16	90	8	VV3066MBULT	\$1,098	\$1,208
	24	60	1 3/16	65	6	VV2460MBULT	\$714	\$786
	24	48	1 3/16	52	5	VV2448MBULT	\$629	\$692

- top edge profile on three open sides
- long grain direction
- supports located below and on pages 265 and 288

Description	D	W	H	CTN WT	CU FT	① Model	Flat Cut List Price	Double Cut List Price
Modular Boomerang Desk Top	30	84	1 3/16	114	10	VV3084MBMTR	\$2,270	\$2,497
 	30	84	1 3/16	114	10	VV3084MBMTL	\$2,270	\$2,497
 left shown	24	84	1 3/16	91	8	VV2484MBMTR	\$1,945	\$2,140
	24	84	1 3/16	91	8	VV2484MBMTL	\$1,945	\$2,140



- top edge profile on three open sides
- long grain direction
- supports located below and on pages 265 and 288

Description	D	W	H	CTN WT	CU FT	① Model	Flat Cut List Price	Double Cut List Price
Full Height "T" Supports	9 3/4	47 5/8	28	42	11	VV1048TSP	\$514	\$565
 	9 3/4	41 5/8	28	38	9	VV1042TSP	\$490	\$539
	9 3/4	35 5/8	28	32	8	VV1036TSP	\$469	\$516
	9 3/4	29 5/8	28	28	7	VV1030TSP	\$450	\$495
	9 3/4	23 5/8	28	24	6	VV1024TSP	\$432	\$476

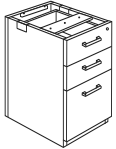
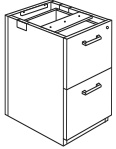
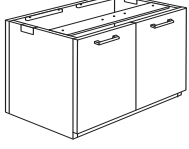
- use with peninsula or modular tops
- one end panel grommet

Description	D	W	H	CTN WT	CU FT	① Model	Flat Cut List Price	Double Cut List Price
Bench Height "T" Supports	9 3/4	47 5/8	8 5/16	18	4	VVB1048TSP	\$489	\$538
 	9 3/4	41 5/8	8 5/16	16	4	VVB1042TSP	\$461	\$508
	9 3/4	35 5/8	8 5/16	15	3	VVB1036TSP	\$444	\$489
	9 3/4	29 5/8	8 5/16	14	3	VVB1030TSP	\$424	\$467
	9 3/4	23 5/8	8 5/16	12	2	VVB1024TSP	\$405	\$446

- use with bench height credenza
- one end panel grommet

VISION - VENEER

Modular

Description	D	W	H	CTN WT	CU FT	① Model	Flat Cut List Price	Double Cut List Price
<b>Modular Box/Box/File Pedestal</b> 	36	16	28	124	12	VV1636MBBF	\$1,287	\$1,416
	30	16	28	110	10	VV1630MBBF	\$1,186	\$1,305
	24	16	28	98	9	VV1624MBBF	\$1,124	\$1,236
	20	16	28	87	7	VV1620MBBF	\$1,077	\$1,185
								<ul style="list-style-type: none"> <li>two end panel grommets</li> <li>letter width pedestal</li> <li>pedestal front locking</li> </ul>
<b>Modular File/File Pedestal</b> 	36	16	28	124	12	VV1636MFF	\$1,287	\$1,416
	30	16	28	110	10	VV1630MFF	\$1,186	\$1,305
	24	16	28	98	9	VV1624MFF	\$1,124	\$1,236
	20	16	28	87	7	VV1620MFF	\$1,077	\$1,185
								<ul style="list-style-type: none"> <li>two end panel grommets</li> <li>letter width pedestal</li> <li>pedestal front locking</li> </ul>
<b>Modular Hinged Door Pedestal</b> 	24	36	28	132	18	VV3624MSC	\$1,390	\$1,529
	20	36	28	120	15	VV3620MSC	\$1,292	\$1,421
	24	30	28	128	15	VV3024MSC	\$1,122	\$1,234
	20	30	28	116	13	VV3020MSC	\$1,070	\$1,178
								<ul style="list-style-type: none"> <li>two end panel grommets</li> <li>adjustable shelf in storage cabinet</li> <li>locking doors available, specify and add \$105 list</li> </ul>

VISION - VENEER

To Order, Specify:

- ① Model Number
- ② Wood Species - Cherry (CH1), Maple (MA1), Walnut (WA1) or Double Cut (see page 228)
- ③ Finish Color (see page 229)
- ④ Edge Profile (see page 233)
- ⑤ Pull Style and Color (see page 233)
- ⑥ Grommet Color - Matte Black (MBK) or Stardust Silver (STS) (see page 234)
- ⑦ Other Product Options (see page 229)
- ⑧ Accessories (see page 407)
- ⑨ Power and Data Options (see page 407)

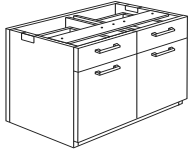
When ordering Quickship products, place a "Q" in front of model number.  
 Example: QVV3072DD





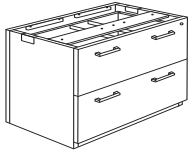
**Modular**

Description	D	W	H	CTN WT	CU FT	① Model	Flat Cut List Price	Double Cut List Price
Modular Buffet Door Pedestal	24	36	34	147	21	VV3624MBSC	\$1,575	\$1,733
<b>NOW!</b>	20	36	34	131	18	VV3620MBSC	\$1,498	\$1,648



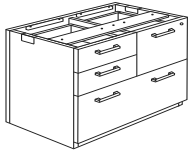
- two end panel grommets
- adjustable shelf in storage cabinet
- locking not available

Modular Lateral File Pedestal	24	36	28	148	18	VV3624MLF	\$1,478	\$1,626
<b>NOW!</b>	20	36	28	133	15	VV3620MLF	\$1,404	\$1,545
	24	30	28	140	15	VV3024MLF	\$1,294	\$1,424
	20	30	28	128	13	VV3020MLF	\$1,231	\$1,355



- two end panel grommets
- pedestal front locking

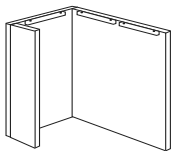
Modular Multi-File Pedestal	24	30	28	152	15	VV3024MRM	\$1,453	\$1,599
<b>NOW!</b>	24	30	28	152	15	VV3024MLM	\$1,453	\$1,599
	20	30	28	137	13	VV3020MRM	\$1,380	\$1,519
	20	30	28	137	13	VV3020MLM	\$1,380	\$1,519



right shown

- two end panel grommets
- pedestal front locking
- top file drawer determines left or right

Wing End Support	48	16	28	58	16	VV1648WEAR	\$541	\$596
<b>NOW!</b>	48	16	28	58	16	VV1648WEAL	\$541	\$596
	42	16	28	54	14	VV1642WEAR	\$521	\$574
	42	16	28	54	14	VV1642WEAL	\$521	\$574
	36	16	28	50	12	VV1636WEAR	\$507	\$558
	36	16	28	50	12	VV1636WEAL	\$507	\$558
	30	16	28	45	10	VV1630WEAR	\$493	\$542
	30	16	28	45	10	VV1630WEAL	\$493	\$542
	24	16	28	41	9	VV1624WEAR	\$482	\$531
	24	16	28	41	9	VV1624WEAL	\$482	\$531
	20	16	28	37	7	VV1620WEAR	\$458	\$504
	20	16	28	37	7	VV1620WEAL	\$458	\$504

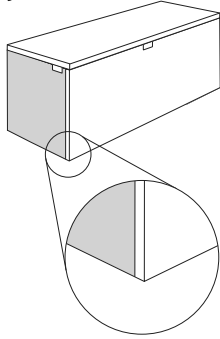


right shown

- one end panel grommet

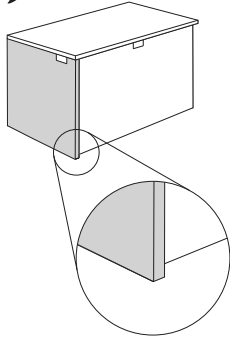
**Modular**

Description	D	W	H	CTN WT	CU FT	① Model	Flat Cut List Price	Double Cut List Price
<b>Modular End Panel for Shell Desks and Credenzas</b>	3/4	46 1/4	28	31	4	VV47EP	\$416	\$458
	3/4	40 1/4	28	27	4	VV41EP	\$403	\$444
	3/4	34 1/4	28	23	3	VV35EP	\$389	\$428
	3/4	28 1/4	28	18	3	VV29EP	\$375	\$413
	3/4	22 1/4	28	14	2	VV23EP	\$343	\$377
	3/4	18 1/4	28	13	2	VV19EP	\$327	\$361



- one end panel grommet
- use to create desk or credenza using modular top and modesty panel
- see page 291 for modesty panels and pages 248-251 for selection guide
- metal attachment brackets field installed to allow for use as right or left

Description	D	W	H	CTN WT	CU FT	① Model	Flat Cut List Price	Double Cut List Price
<b>Modular End Panel for Return Shell</b>	3/4	47 5/8	28	31	4	VV48EP	\$416	\$458
	3/4	41 5/8	28	27	4	VV42EP	\$403	\$444
	3/4	35 5/8	28	23	3	VV36EP	\$389	\$428
	3/4	29 5/8	28	19	3	VV30EP	\$375	\$413
	3/4	23 5/8	28	15	2	VV24EP	\$343	\$377
	3/4	19 5/8	28	13	2	VV20EP	\$327	\$361



- one end panel grommet
- use to create return shell using modular top and modesty panel
- see page 291 for modesty panels and pages 248-251 for selection guide
- metal attachment brackets field installed to allow for use as right or left

**To Order, Specify:**

- ① Model Number
- ② Wood Species - Cherry (CH1), Maple (MA1), Walnut (WA1) or Double Cut (see page 228)
- ③ Finish Color (see page 229)
- ④ Edge Profile (see page 233)
- ⑤ Pull Style and Color (see page 233)
- ⑥ Grommet Color - Matte Black (MBK) or Stardust Silver (STS) (see page 234)
- ⑦ Other Product Options (see page 229)

When ordering Quickship products, place a "Q" in front of model number.  
Example: QVV3072DD

**NOW!**  
Need it.  
JSI Quickship

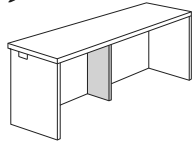
**Modular**

Description	D	W	H	CTN WT	CU FT	① Model	Flat Cut List Price	Double Cut List Price
-------------	---	---	---	-----------	----------	---------	------------------------	--------------------------

**Modular Center Support Panel**

$\frac{3}{4}$	12	28	8	1	VV12SP	\$278	\$306
---------------	----	----	---	---	--------	-------	-------

**Now!**

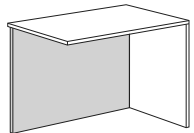


- one end panel grommet
- used for modular with an unsupported span greater than 48"
- NOT FOR USE ON THE END OF THE UNIT. Used as additional support for center of top
- MUST be used in conjunction with a modesty panel
- see page 291 for modesty panels and pages 248-251 for selection guide
- metal attachment brackets field installed

**Modular Shell Return Modesty Panel**

$\frac{3}{4}$	54 $\frac{1}{16}$	28	32	4	VV2855MA	\$426	\$469
$\frac{3}{4}$	48 $\frac{1}{16}$	28	28	4	VV2849MA	\$419	\$461
$\frac{3}{4}$	42 $\frac{1}{16}$	28	25	3	VV2843MA	\$363	\$399
$\frac{3}{4}$	36 $\frac{1}{16}$	28	21	3	VV2837MA	\$340	\$374

**Now!**

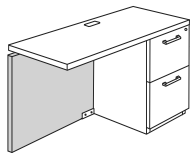


- one modesty panel grommet
- extends  $\frac{7}{8}$ " inside of connecting unit back panel
- use with VV24EP and modular top to make shell return
- see specification guide on pages 248-251 to determine proper size and model for your application

**Modular Pedestal Return Modesty Panel**

$\frac{3}{4}$	45 $\frac{3}{16}$	28	27	4	VV2845MA	\$406	\$447
$\frac{3}{4}$	39 $\frac{3}{16}$	28	23	3	VV2839MA	\$352	\$388
$\frac{3}{4}$	33 $\frac{3}{16}$	28	20	3	VV2833MA	\$330	\$364
$\frac{3}{4}$	30 $\frac{15}{16}$	28	19	3	VV2831MA	\$325	\$357
$\frac{3}{4}$	27 $\frac{3}{16}$	28	16	2	VV2827MA	\$319	\$351
$\frac{3}{4}$	24 $\frac{15}{16}$	28	15	2	VV2824MA	\$317	\$349
$\frac{3}{4}$	21 $\frac{3}{16}$	28	13	2	VV2821MA	\$315	\$347
$\frac{3}{4}$	18 $\frac{15}{16}$	28	12	2	VV2818MA	\$313	\$345
$\frac{3}{4}$	12 $\frac{15}{16}$	28	8	1	VV2812MA	\$310	\$342
$\frac{3}{4}$	6 $\frac{15}{16}$	28	5	1	VV2807MA	\$298	\$328

**Now!**

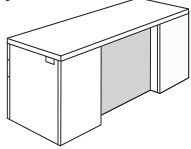


\* If desired application is not listed, contact customer service for a quote.

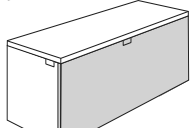
- one modesty panel grommet
- extends  $\frac{7}{8}$ " inside of connecting unit back panel
- see specification guide on pages 248-251 to determine proper size and model for your application

VISION - VENEER

Modular

Description	D	W	H	CTN WT	CU FT	① Model	Flat Cut List Price	Double Cut List Price
<b>Modular Break Front Desk and Credenza Modesty Panels</b> 	3/4	58 5/8	28	35	4	VV2859MA	\$428	\$471
	3/4	52 5/8	28	31	4	VV2853MA	\$426	\$469
	3/4	50 3/8	28	30	4	VV2850MA	\$422	\$465
	3/4	46 5/8	28	28	4	VV2847MA	\$419	\$461
	3/4	44 3/8	28	26	4	VV2844MA	\$364	\$401
	3/4	40 5/8	28	24	4	VV2840MA	\$357	\$393
	3/4	38 3/8	28	23	4	VV2838MA	\$338	\$372
	3/4	34 5/8	28	21	3	VV2834MA	\$327	\$361
	3/4	32 3/8	28	19	3	VV2832MA	\$325	\$357
	3/4	28 5/8	28	17	2	VV2828MA	\$319	\$351
	3/4	26 3/8	28	16	2	VV2826MA	\$318	\$350
	3/4	20 3/8	28	12	2	VV2820MA	\$315	\$347
	3/4	14 3/8	28	9	2	VV2814MA	\$311	\$343

- one modesty panel grommet
  - see specification guide on pages 248-251 to determine proper size and model for your application
- Note: If desired application is not listed contact customer service for a quote.

<b>Modular Desk and Credenza Shell Modesty Panels</b> 	3/4	59 7/8	28	35	4	VV2860MA	\$428	\$471
	3/4	53 7/8	28	32	4	VV2854MA	\$426	\$469
	3/4	47 7/8	28	28	4	VV2848MA	\$419	\$461
	3/4	41 7/8	28	25	3	VV2842MA	\$363	\$399
	3/4	35 7/8	28	21	3	VV2836MA	\$340	\$374
	3/4	29 7/8	28	18	2	VV2830MA	\$323	\$355

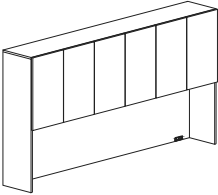
- one modesty panel grommet
  - use with two VV23EP end panels
  - see pages 248-251 for selection guide
- Note: If desired application is not listed contact customer service for a quote.

To Order, Specify:

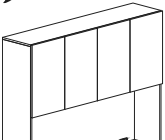
- ① Model Number
- ② Wood Species - Cherry (CH1), Maple (MA1), Walnut (WA1) or Double Cut (see page 228)
- ③ Finish Color (see page 229)
- ④ Grommet Color - Matte Black (MBK) or Stardust Silver (STS) (see page 234)
- ⑤ Other Product Options (see page 229)

When ordering Quickship products, place a "Q" in front of model number.  
 Example: QVV3072DD

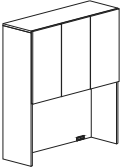
**NOW!**  
 Need it.  
 JSI Quickship

Description	D	W	H	CTN WT	CU FT	① Model	Flat Cut List Price	Double Cut List Price
<b>Double Height Storage Overhead Cabinet with Six Doors</b> 	16	108	54	421	65	<b>VV16108DSO</b>	\$4,019	\$4,421
	16	102	54	398	61	<b>VV16102DSO</b>	\$3,788	\$4,167
	16	96	54	375	58	<b>VV1696DSO</b>	\$3,560	\$3,916
	16	90	54	351	54	<b>VV1690DSO</b>	\$3,410	\$3,751


- grommets in bottom left and right and in top center of back panel
- tackboards available, see pages 306-309 or 320-323
- task lights available, see page 412
- locking doors available, specify and add \$315 list
- 25" vertical clearance from desk top to bottom of light soffit
- no pulls
- backside of unit intended to go against a wall, cabinet should be secured to a wall as a safety precaution

<b>Double Height Storage Overhead Cabinet with Four Doors</b> 	16	84	54	314	51	<b>VV1684DSO</b>	\$3,143	\$3,458
	16	78	54	297	47	<b>VV1678DSO</b>	\$2,932	\$3,226
	16	72	54	281	44	<b>VV1672DSO</b>	\$2,734	\$3,008
	16	66	54	265	40	<b>VV1666DSO</b>	\$2,611	\$2,872
	16	60	54	249	37	<b>VV1660DSO</b>	\$2,495	\$2,745
	16	54	54	225	33	<b>VV1654DSO</b>	\$2,400	\$2,640

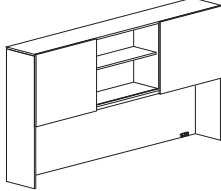
- grommets in bottom left and right and in top center of back panel
- tackboards available, see pages 306-309 or 320-323
- task lights available, see page 412
- locking doors available, specify and add \$210 list
- 25" vertical clearance from desk top to bottom of light soffit
- no pulls
- backside of unit intended to go against a wall, cabinet should be secured to a wall as a safety precaution

<b>Double Height Storage Overhead Cabinet with Three Doors</b> 	16	48	54	198	30	<b>VV1648DSOR</b>	\$2,318	\$2,550
	16	48	54	198	30	<b>VV1648DSOL</b>	\$2,318	\$2,550
	16	42	54	174	26	<b>VV1642DSOR</b>	\$2,243	\$2,468
	16	42	54	174	26	<b>VV1642DSOL</b>	\$2,243	\$2,468

- grommets in bottom left and right and in top center of back panel
- tackboards available, see pages 306-309 or 320-323
- task lights available, see page 412
- locking doors available, specify and add \$210 list
- 25" vertical clearance from desk top to bottom of light soffit
- no pulls
- backside of unit intended to go against a wall, cabinet should be secured to a wall as a safety precaution

<b>Double Height Storage Overhead Cabinet with Two Doors</b> 	16	36	54	148	23	<b>VV1636DSO</b>	\$2,175	\$2,393
	16	30	54	130	19	<b>VV1630DSO</b>	\$2,040	\$2,244

- grommets in bottom left and right and in top center of back panel
- tackboards available, see pages 306-309 or 320-323
- task lights available, see page 412
- locking doors available, specify and add \$105 list
- 25" vertical clearance from desk top to bottom of light soffit
- no pulls
- backside of unit intended to go against a wall, cabinet should be secured to a wall as a safety precaution

Description	D	W	H	CTN WT	CU FT	① Model	Flat Cut List Price	Double Cut List Price
<b>Double Height Storage Overhead Cabinet with Two Sliding Doors</b> 	16	108	54	421	65	WV16108DSD	\$4,367	\$4,804
	16	102	54	398	61	WV16102DSD	\$4,143	\$4,557
	16	96	54	375	58	WV1696DSD	\$3,921	\$4,314
	16	90	54	351	54	WV1690DSD	\$3,785	\$4,164

**NOW!**

- grommets in bottom left and right and in top center of back panel
- tackboards available, see pages 306-309 or 320-323
- task lights available, see page 412
- 25" vertical clearance from desk top to bottom of light soffit
- white markerboard door available, specify and add \$431 list
- locking doors not available
- pulls not available
- backside of unit intended to go against a wall, cabinet should be secured to a wall as a safety precaution

<b>Double Height Storage Overhead Cabinet with Sliding Door</b> 	16	84	54	314	51	WV1684DSD	\$3,519	\$3,872
	16	78	54	297	47	WV1678DSD	\$3,307	\$3,638
	16	72	54	281	44	WV1672DSD	\$3,070	\$3,377
	16	66	54	265	40	WV1666DSD	\$2,947	\$3,242
	16	60	54	249	37	WV1660DSD	\$2,830	\$3,114
	16	54	54	225	33	WV1654DSD	\$2,735	\$3,009
	16	48	54	198	30	WV1648DSD	\$2,653	\$2,918
	16	42	54	174	26	WV1642DSD	\$2,579	\$2,838
	16	36	54	148	23	WV1636DSD	\$2,511	\$2,763
	16	30	54	130	19	WV1630DSD	\$2,454	\$2,700

**NOW!**

- grommets in bottom left and right and in top center of back panel
- tackboards available, see pages 306-309 or 320-323
- task lights available, see page 412
- 25" vertical clearance from desk top to bottom of light soffit
- white markerboard door available, specify and add \$216 list
- locking doors not available
- pulls not available
- backside of unit intended to go against a wall, cabinet should be secured to a wall as a safety precaution

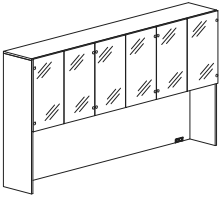
**To Order, Specify:**

- ① Model Number
- ② Wood Species - Cherry (CH1), Maple (MA1), Walnut (WA1) or Double Cut (see page 228)
- ③ Finish Color (see page 229)
- ④ Grommet Color - Matte Black (MBK) or Stardust Silver (STS) (see page 234)
- ⑤ Other Product Options (see page 229)

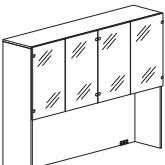
When ordering Quickship products, place a "Q" in front of model number.  
 Example: QV3072DD

**NOW!**  
*Need it.*  
 JSI Quickship

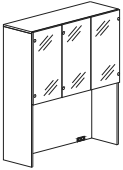
VISION - VENEER

Description	D	W	H	CTN WT	CU FT	① Model	Flat Cut List		Double Cut List	
							Frameless	Aluminum Frame	Frameless	Aluminum Frame
<b>Double Height Storage Overhead Cabinet with Six Glass Doors</b> 	16	108	54	421	65	<b>VW16108DGSO</b>	\$4,420	\$5,484	\$4,862	\$6,033
	16	102	54	398	61	<b>VW16102DGSO</b>	\$4,280	\$5,328	\$4,709	\$5,862
	16	96	54	375	58	<b>VW1696DGSO</b>	\$4,023	\$5,052	\$4,426	\$5,558
	16	90	54	351	54	<b>VW1690DGSO</b>	\$3,785	\$4,796	\$4,164	\$5,276

- select Frosted Frameless, Frosted with Aluminum Frame or White Back Painted with Aluminum Frame
- grommets in bottom left and right and in top center of back panel
- tackboards available, see pages 306-309 or 320-323
- task lights available, see page 412
- 25" vertical clearance from desk top to bottom of light soffit
- locking doors not available
- pulls not available
- backside of unit intended to go against a wall, cabinet should be secured to a wall as a safety precaution

<b>Double Height Storage Overhead Cabinet with Four Glass Doors</b> 	16	84	54	314	51	<b>VW1684DGSO</b>	\$3,489	\$4,234	\$3,838	\$4,658
	16	78	54	297	47	<b>VW1678DGSO</b>	\$3,284	\$4,011	\$3,612	\$4,413
	16	72	54	281	44	<b>VW1672DGSO</b>	\$3,143	\$3,852	\$3,458	\$4,237
	16	66	54	265	40	<b>VW1666DGSO</b>	\$3,002	\$3,695	\$3,303	\$4,065
	16	60	54	249	37	<b>VW1660DGSO</b>	\$2,844	\$3,518	\$3,128	\$3,870

- select Frosted Frameless, Frosted with Aluminum Frame or White Back Painted with Aluminum Frame
- grommets in bottom left and right and in top center of back panel
- tackboards available, see pages 306-309 or 320-323
- task lights available, see page 412
- 25" vertical clearance from desk top to bottom of light soffit
- locking doors not available
- pulls not available
- backside of unit intended to go against a wall, cabinet should be secured to a wall as a safety precaution

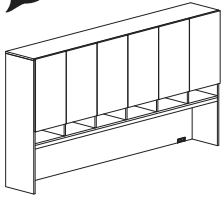
<b>Double Height Storage Overhead Cabinet with Three Glass Doors</b> 	16	48	54	198	30	<b>VW1648DGSOR</b>	\$2,641	\$3,157	\$2,906	\$3,473
	16	48	54	198	30	<b>VW1648DGSOL</b>	\$2,641	\$3,157	\$2,906	\$3,473
	16	42	54	174	26	<b>VW1642DGSOR</b>	\$2,557	\$3,054	\$2,813	\$3,359
	16	42	54	174	26	<b>VW1642DGSOL</b>	\$2,557	\$3,054	\$2,813	\$3,359

- select Frosted Frameless, Frosted with Aluminum Frame or White Back Painted with Aluminum Frame
- grommets in bottom left and right and in top center of back panel
- tackboards available, see pages 306-309 or 320-323
- task lights available, see page 412
- 25" vertical clearance from desk top to bottom of light soffit
- locking doors not available
- pulls not available
- backside of unit intended to go against a wall, cabinet should be secured to a wall as a safety precaution

<b>Double Height Storage Overhead Cabinet with Two Glass Doors</b> 	16	36	54	148	23	<b>VW1636DGSO</b>	\$2,414	\$2,769	\$2,656	\$3,047
	16	30	54	130	19	<b>VW1630DGSO</b>	\$2,341	\$2,678	\$2,575	\$2,946

- select Frosted Frameless, Frosted with Aluminum Frame or White Back Painted with Aluminum Frame
- grommets in bottom left and right and in top center of back panel
- tackboards available, see pages 306-309 or 320-323
- task lights available, see page 412
- 25" vertical clearance from desk top to bottom of light soffit
- locking doors not available
- pulls not available
- backside of unit intended to go against a wall, cabinet should be secured to a wall as a safety precaution

VISION - VENEER

Description	D	W	H	CTN WT	CU FT	① Model	Flat Cut List Price	Double Cut List Price
<b>Double Height Storage Overhead Cabinet with Six Doors and Cubbies</b> 	16	108	54	466	65	<b>WV16108DSOC</b>	\$4,741	\$5,216
	16	102	54	441	61	<b>WV16102DSOC</b>	\$4,469	\$4,917
	16	96	54	415	58	<b>WV1696DSOC</b>	\$4,202	\$4,623
	16	90	54	389	54	<b>WV1690DSOC</b>	\$4,023	\$4,426

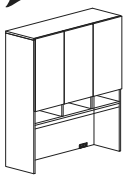
**NOW!**

- grommets in bottom left and right and in top center of back panel
- tackboards available, see pages 310-313 or 324-327
- task lights available, see page 412
- locking doors available, specify and add \$315 list
- 19" vertical clearance from desk top to bottom of light soffit
- no pulls
- backside of unit intended to go against a wall, cabinet should be secured to a wall as a safety precaution

<b>Double Height Storage Overhead Cabinet with Four Doors and Cubbies</b> 	16	84	54	349	51	<b>WV1684DSOC</b>	\$3,804	\$4,185
	16	78	54	330	47	<b>WV1678DSOC</b>	\$3,547	\$3,902
	16	72	54	311	44	<b>WV1672DSOC</b>	\$3,308	\$3,639
	16	66	54	293	40	<b>WV1666DSOC</b>	\$3,159	\$3,475
	16	60	54	274	37	<b>WV1660DSOC</b>	\$3,018	\$3,321
	16	54	54	248	33	<b>WV1654DSOC</b>	\$2,903	\$3,194

**NOW!**

- grommets in bottom left and right and in top center of back panel
- tackboards available, see pages 310-313 or 324-327
- task lights available, see page 412
- locking doors available, specify and add \$210 list
- 19" vertical clearance from desk top to bottom of light soffit
- no pulls
- backside of unit intended to go against a wall, cabinet should be secured to a wall as a safety precaution

<b>Double Height Storage Overhead Cabinet with Three Doors and Cubbies</b> 	16	48	54	218	30	<b>WV1648DSOCR</b>	\$2,723	\$2,996
	16	48	54	218	30	<b>WV1648DSOCL</b>	\$2,723	\$2,996
	16	42	54	192	26	<b>WV1642DSOCR</b>	\$2,636	\$2,900
	16	42	54	192	26	<b>WV1642DSOCL</b>	\$2,636	\$2,900

**NOW!**

- grommets in bottom left and right and in top center of back panel
- tackboards available, see pages 310-313 or 324-327
- task lights available, see page 412
- locking doors available, specify and add \$210 list
- 19" vertical clearance from desk top to bottom of light soffit
- no pulls
- backside of unit intended to go against a wall, cabinet should be secured to a wall as a safety precaution

**To Order, Specify:**

- ① Model Number
- ② Wood Species - Cherry (CH1), Maple (MA1), Walnut (WA1) or Double Cut (see page 228)
- ③ Finish Color (see page 229)
- ④ Glass Option/Color (see page 237)
- ⑤ Grommet Color - Matte Black (MBK) or Stardust Silver (STS) (see page 234)
- ⑥ Other Product Options (see page 229)

When ordering Quickship products, place a "Q" in front of model number.  
 Example: QVW3072DD

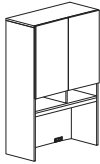
**NOW!**  
*Need it.*  
 JSI Quickship

VISION - VENEER



Description	D	W	H	CTN WT	CU FT	① Model	Flat Cut List Price	Double Cut List Price
Double Height Storage Overhead Cabinet with Two Doors and Cubbies	16	36	54	163	23	VV1636DSOC	\$2,502	\$2,753
	16	30	54	143	19	VV1630DSOC	\$2,446	\$2,691

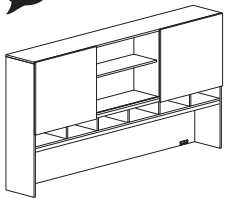
**NOW!**



- grommets in bottom left and right and in top center of back panel
- tackboards available, see pages 310-313 or 324-327
- task lights available, see page 412
- locking doors available, specify and add \$105 list
- 19" vertical clearance from desk top to bottom of light soffit
- no pulls
- backside of unit intended to go against a wall, cabinet should be secured to a wall as a safety precaution

Double Height Storage Overhead Cabinet with Two Sliding Doors and Cubbies	16	108	54	466	65	VV16108DSDC	\$4,918	\$5,410
	16	102	54	441	61	VV16102DSDC	\$4,673	\$5,140
	16	96	54	415	58	VV1696DSDC	\$4,509	\$4,961
	16	90	54	389	54	VV1690DSDC	\$4,294	\$4,723

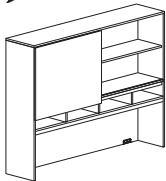
**NOW!**



- grommets in bottom left and right and in top center of back panel
- tackboards available, see pages 310-313 or 324-327
- task lights available, see page 412
- 19" vertical clearance from desk top to bottom of light soffit
- white markerboard door available, specify and add \$431 list
- locking doors not available
- pulls not available
- backside of unit intended to go against a wall, cabinet should be secured to a wall as a safety precaution

Double Height Storage Overhead Cabinet with Sliding Door and Cubbies	16	84	54	349	51	VV1684DSDC	\$3,996	\$4,396
	16	78	54	330	47	VV1678DSDC	\$3,755	\$4,131
	16	72	54	311	44	VV1672DSDC	\$3,485	\$3,834
	16	66	54	293	40	VV1666DSDC	\$3,346	\$3,681
	16	60	54	274	37	VV1660DSDC	\$3,215	\$3,537
	16	54	54	248	33	VV1654DSDC	\$3,105	\$3,416

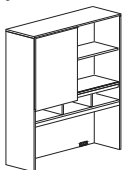
**NOW!**



- grommets in bottom left and right and in top center of back panel
- tackboards available, see pages 310-313 or 324-327
- task lights available, see page 412
- 19" vertical clearance from desk top to bottom of light soffit
- white markerboard door available, specify and add \$216 list
- locking doors not available
- pulls not available
- backside of unit intended to go against a wall, cabinet should be secured to a wall as a safety precaution

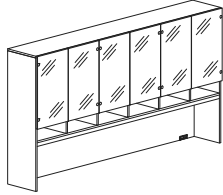
Double Height Storage Overhead Cabinet with Sliding Door and Cubbies	16	48	54	218	30	VV1648DSDC	\$2,926	\$3,219
	16	42	54	192	26	VV1642DSDC	\$2,844	\$3,128
	16	36	54	163	23	VV1636DSDC	\$2,711	\$2,982
	16	30	54	143	19	VV1630DSDC	\$2,671	\$2,938

**NOW!**



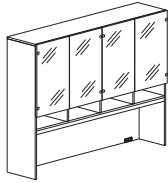
- grommets in bottom left and right and in top center of back panel
- tackboards available, see pages 310-313 or 324-327
- task lights available, see page 412
- 19" vertical clearance from desk top to bottom of light soffit
- white markerboard door available, specify and add \$216 list
- locking doors not available
- pulls not available
- backside of unit intended to go against a wall, cabinet should be secured to a wall as a safety precaution

Description	D	W	H	CTN WT	CU FT	① Model	Flat Cut List		Double Cut List	
							Frameless	Aluminum Frame	Frameless	Aluminum Frame
<b>Double Height Storage Overhead Cabinet with Six Glass Doors and Cubbies</b>	16	108	54	466	65	<b>WV16108DGSOC</b>	\$5,216	\$6,279	\$5,738	\$6,907
	16	102	54	441	61	<b>WV16102DGSOC</b>	\$4,917	\$5,964	\$5,409	\$6,561
	16	96	54	415	58	<b>WV1696DGSOC</b>	\$4,622	\$5,651	\$5,085	\$6,216
	16	90	54	389	54	<b>WV1690DGSOC</b>	\$4,425	\$5,436	\$4,868	\$5,980



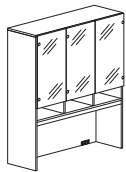
- select Frosted Frameless, Frosted with Aluminum Frame or White Back Painted with Aluminum Frame
- grommets in bottom left and right and in top center of back panel
- tackboards available, see pages 310-313 or 324-327
- task lights available, see page 412
- 19" vertical clearance from desk top to bottom of light soffit
- locking doors not available
- pulls not available
- backside of unit intended to go against a wall, cabinet should be secured to a wall as a safety precaution

<b>Double Height Storage Overhead Cabinet with Four Glass Doors and Cubbies</b>	16	84	54	349	51	<b>WV1684DGSOC</b>	\$4,069	\$4,815	\$4,477	\$5,297
	16	78	54	330	47	<b>WV1678DGSOC</b>	\$3,795	\$4,523	\$4,175	\$4,975
	16	72	54	311	44	<b>WV1672DGSOC</b>	\$3,539	\$4,248	\$3,893	\$4,673
	16	66	54	293	40	<b>WV1666DGSOC</b>	\$3,475	\$4,168	\$3,822	\$4,585
	16	60	54	274	37	<b>WV1660DGSOC</b>	\$3,321	\$3,995	\$3,653	\$4,395
	16	54	54	248	33	<b>WV1654DGSOC</b>	\$3,194	\$3,851	\$3,514	\$4,236



- select Frosted Frameless, Frosted with Aluminum Frame or White Back Painted with Aluminum Frame
- grommets in bottom left and right and in top center of back panel
- tackboards available, see pages 310-313 or 324-327
- task lights available, see page 412
- 19" vertical clearance from desk top to bottom of light soffit
- locking doors not available
- pulls not available
- backside of unit intended to go against a wall, cabinet should be secured to a wall as a safety precaution

<b>Double Height Storage Overhead Cabinet with Three Glass Doors and Cubbies</b>	16	48	54	218	30	<b>WV1648DGSOCR</b>	\$2,995	\$3,511	\$3,295	\$3,862
	16	48	54	218	30	<b>WV1648DGSOCL</b>	\$2,995	\$3,511	\$3,295	\$3,862
	16	42	54	192	26	<b>WV1642DGSOCR</b>	\$2,900	\$3,396	\$3,190	\$3,736
	16	42	54	192	26	<b>WV1642DGSOCL</b>	\$2,900	\$3,396	\$3,190	\$3,736



- select Frosted Frameless, Frosted with Aluminum Frame or White Back Painted with Aluminum Frame
- grommets in bottom left and right and in top center of back panel
- tackboards available, see pages 310-313 or 324-327
- task lights available, see page 412
- 19" vertical clearance from desk top to bottom of light soffit
- locking doors not available
- pulls not available
- backside of unit intended to go against a wall, cabinet should be secured to a wall as a safety precaution

**To Order, Specify:**

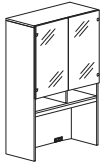
- ① Model Number
- ② Wood Species - Cherry (CH1), Maple (MA1), Walnut (WA1) or Double Cut (see page 228)
- ③ Finish Color (see page 229)
- ④ Glass Option/Color (see page 237)
- ⑤ Grommet Color - Matte Black (MBK) or Stardust Silver (STS) (see page 234)
- ⑥ Other Product Options (see page 229)

When ordering Quickship products, place a "Q" in front of model number.  
Example: QV3072DD

**NOW!**  
Need it.  
JSI Quickship

VISION - VENEER

Description	D	W	H	CTN WT	CU FT	① Model	Flat Cut List		Double Cut List	
							Frameless	Aluminum Frame	Frameless	Aluminum Frame
Double Height Storage Overhead Cabinet with Two Glass Doors and Cubbies	16	36	54	163	23	<b>VW1636DGSOC</b>	\$2,726	\$3,081	\$2,999	\$3,390
	16	30	54	143	19	<b>VW1630DGSOC</b>	\$2,665	\$3,002	\$2,932	\$3,303



- select Frosted Frameless, Frosted with Aluminum Frame or White Back Painted with Aluminum Frame
- grommets in bottom left and right and in top center of back panel
- tackboards available, see pages 310-313 or 324-327
- task lights available, see page 412
- 19" vertical clearance from desk top to bottom of light soffit
- locking doors not available
- pulls not available
- backside of unit intended to go against a wall, cabinet should be secured to a wall as a safety precaution

Description	D	W	H	CTN WT	CU FT	① Model	Flat Cut List Price	Double Cut List Price
	16	102	42	309	48	<b>VW16102SO</b>	\$3,079	\$3,388
	16	96	42	291	45	<b>VW1696SO</b>	\$2,848	\$3,134
	16	90	42	273	43	<b>VW1690SO</b>	\$2,622	\$2,885

- grommets in bottom left and right and in top center of back panel
- tackboards available, see pages 306-309 or 320-323
- task lights available, see page 412
- locking doors available, specify and add \$315 list
- 25" vertical clearance from desk top to bottom of light soffit
- no pulls

	Storage Overhead Cabinet with Four Doors	16	84	42	244	40	<b>VW1684SO</b>	\$2,418	\$2,660
		16	78	42	231	37	<b>VW1678SO</b>	\$2,255	\$2,481
		16	72	42	218	34	<b>VW1672SO</b>	\$2,103	\$2,314
		16	66	42	206	32	<b>VW1666SO</b>	\$2,008	\$2,210
		16	60	42	193	29	<b>VW1660SO</b>	\$1,919	\$2,111
		16	54	42	175	26	<b>VW1654SO</b>	\$1,845	\$2,030

- grommets in bottom left and right and in top center of back panel
- tackboards available, see pages 306-309 or 320-323
- task lights available, see page 412
- locking doors available, specify and add \$210 list
- 25" vertical clearance from desk top to bottom of light soffit
- no pulls

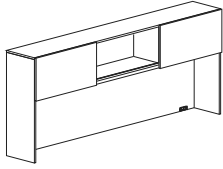
	Storage Overhead Cabinet with Three Doors	16	48	42	154	23	<b>VW1648SOR</b>	\$1,782	\$1,961
		16	48	42	154	23	<b>VW1648SOL</b>	\$1,782	\$1,961
		16	42	42	135	21	<b>VW1642SOR</b>	\$1,726	\$1,899
		16	42	42	135	21	<b>VW1642SOL</b>	\$1,726	\$1,899

- grommets in bottom left and right and in top center of back panel
- tackboards available, see pages 306-309 or 320-323
- task lights available, see page 412
- locking doors available, specify and add \$210 list
- 25" vertical clearance from desk top to bottom of light soffit
- no pulls

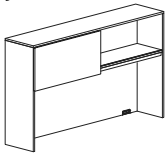
	Storage Overhead Cabinet with Two Doors	16	36	42	115	18	<b>VW1636SO</b>	\$1,673	\$1,841
		16	30	42	101	15	<b>VW1630SO</b>	\$1,629	\$1,793

- grommets in bottom left and right and in top center of back panel
- tackboards available, see pages 306-309 or 320-323
- task lights available, see page 412
- locking doors available, specify and add \$105 list
- 25" vertical clearance from desk top to bottom of light soffit
- no pulls

VISION - VENEER

Description	D	W	H	CTN WT	CU FT	① Model	Flat Cut List Price	Double Cut List Price
<b>Storage Overhead Cabinet with Two Sliding Doors</b> 	16	108	42	327	51	<b>WV16108SD</b>	\$3,609	\$3,971
	16	102	42	309	48	<b>WV16102SD</b>	\$3,368	\$3,705
	16	96	42	291	45	<b>WV1696SD</b>	\$3,137	\$3,451
	16	90	42	273	43	<b>WV1690SD</b>	\$2,911	\$3,203

- grommets in bottom left and right and in top center of back panel
- tackboards available, see pages 306-309 or 320-323
- task lights available, see page 412
- 25" vertical clearance from desk top to bottom of light soffit
- white markerboard door available, specify and add \$326 list
- locking doors not available
- pulls not available

Description	D	W	H	CTN WT	CU FT	① Model	Flat Cut List Price	Double Cut List Price
<b>Storage Overhead Cabinet with Sliding Door</b> 	16	84	42	244	40	<b>WV1684SD</b>	\$2,706	\$2,977
	16	78	42	231	37	<b>WV1678SD</b>	\$2,544	\$2,799
	16	72	42	218	34	<b>WV1672SD</b>	\$2,361	\$2,597
	16	66	42	206	32	<b>WV1666SD</b>	\$2,266	\$2,493
	16	60	42	193	29	<b>WV1660SD</b>	\$2,177	\$2,396
	16	54	42	175	26	<b>WV1654SD</b>	\$2,104	\$2,315
	16	48	42	154	23	<b>WV1648SD</b>	\$2,041	\$2,245
	16	42	42	135	21	<b>WV1642SD</b>	\$1,984	\$2,182
	16	36	42	115	18	<b>WV1636SD</b>	\$1,931	\$2,125
	16	30	42	101	15	<b>WV1630SD</b>	\$1,887	\$2,076

- grommets in bottom left and right and in top center of back panel
- tackboards available, see pages 306-309 or 320-323
- task lights available, see page 412
- 25" vertical clearance from desk top to bottom of light soffit
- white markerboard door available, specify and add \$163 list
- locking doors not available
- pulls not available

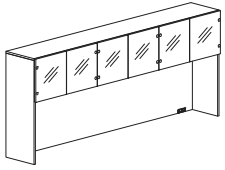
**To Order, Specify:**

- ① Model Number
- ② Wood Species - Cherry (CH1), Maple (MA1), Walnut (WA1) or Double Cut (see page 228)
- ③ Finish Color (see page 229)
- ④ Glass Option/Color (see page 237)
- ⑤ Grommet Color - Matte Black (MBK) or Stardust Silver (STS) (see page 234)
- ⑥ Other Product Options (see page 229)

When ordering Quickship products, place a "Q" in front of model number.  
Example: QV3072DD

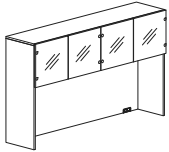


Description	D	W	H	CTN WT	CU FT	① Model	Flat Cut List		Double Cut List	
							Frameless	Aluminum Frame	Frameless	Aluminum Frame
Storage Overhead Cabinet with Six Glass Doors	16	108	42	327	51	<b>VW16108GSO</b>	\$3,653	\$4,526	\$4,019	\$4,979
	16	102	42	309	48	<b>VW16102GSO</b>	\$3,414	\$4,274	\$3,756	\$4,701
	16	96	42	291	45	<b>VW1696GSO</b>	\$3,290	\$4,130	\$3,620	\$4,544
	16	90	42	273	43	<b>VW1690GSO</b>	\$3,030	\$3,855	\$3,333	\$4,241



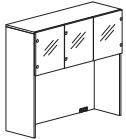
- select Frosted Frameless, Frosted with Aluminum Frame or White Back Painted with Aluminum Frame
- grommets in bottom left and right and in top center of back panel
- tackboards available, see pages 306-309 or 320-323
- task lights available, see page 412
- 25" vertical clearance from desk top to bottom of light soffit
- locking doors not available
- pulls not available

Storage Overhead Cabinet with Four Glass Doors	16	84	42	244	40	<b>VW1684GSO</b>	\$2,792	\$3,409	\$3,072	\$3,750
	16	78	42	231	37	<b>VW1678GSO</b>	\$2,549	\$3,137	\$2,804	\$3,451
	16	72	42	218	34	<b>VW1672GSO</b>	\$2,314	\$2,895	\$2,546	\$3,185
	16	66	42	206	32	<b>VW1666GSO</b>	\$2,210	\$2,777	\$2,431	\$3,055
	16	60	42	193	29	<b>VW1660GSO</b>	\$2,188	\$2,738	\$2,407	\$3,012
	16	54	42	175	26	<b>VW1654GSO</b>	\$2,104	\$2,639	\$2,315	\$2,904



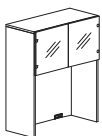
- select Frosted Frameless, Frosted with Aluminum Frame or White Back Painted with Aluminum Frame
- grommets in bottom left and right and in top center of back panel
- tackboards available, see pages 306-309 or 320-323
- task lights available, see page 412
- 25" vertical clearance from desk top to bottom of light soffit
- locking doors not available
- pulls not available

Storage Overhead Cabinet with Three Glass Doors	16	48	42	154	23	<b>VW1648GSOR</b>	\$2,032	\$2,453	\$2,236	\$2,699
	16	48	42	154	23	<b>VW1648GSOL</b>	\$2,032	\$2,453	\$2,236	\$2,699
	16	42	42	135	21	<b>VW1642GSOR</b>	\$1,968	\$2,370	\$2,166	\$2,608
	16	42	42	135	21	<b>VW1642GSOL</b>	\$1,968	\$2,370	\$2,166	\$2,608

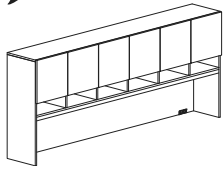


- select Frosted Frameless, Frosted with Aluminum Frame or White Back Painted with Aluminum Frame
- grommets in bottom left and right and in top center of back panel
- tackboards available, see pages 306-309 or 320-323
- task lights available, see page 412
- 25" vertical clearance from desk top to bottom of light soffit
- locking doors not available
- pulls not available

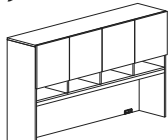
Storage Overhead Cabinet with Two Glass Doors	16	36	42	115	18	<b>VW1636GSO</b>	\$1,858	\$2,150	\$2,044	\$2,365
	16	30	42	101	15	<b>VW1630GSO</b>	\$1,800	\$2,076	\$1,981	\$2,284



- select Frosted Frameless, Frosted with Aluminum Frame or White Back Painted with Aluminum Frame
- grommets in bottom left and right and in top center of back panel
- tackboards available, see pages 306-309 or 320-323
- task lights available, see page 412
- 25" vertical clearance from desk top to bottom of light soffit
- locking doors not available
- pulls not available

Description	D	W	H	CTN WT	CU FT	① Model	Flat Cut List Price	Double Cut List Price
<b>Storage Overhead Cabinet with Six Doors and Cubbies</b> 	16	108	42	372	51	<b>WV16108SOC</b>	\$4,227	\$4,650
	16	102	42	352	48	<b>WV16102SOC</b>	\$3,985	\$4,384
	16	96	42	331	45	<b>WV1696SOC</b>	\$3,754	\$4,130
	16	90	42	311	43	<b>WV1690SOC</b>	\$3,415	\$3,757

- grommets in bottom left and right and in top center of back panel
- tackboards available, see pages 310-313 or 324-327
- task lights available, see page 412
- locking doors available, specify and add \$315 list
- 19" vertical clearance from desk top to bottom of light soffit
- no pulls

<b>Storage Overhead Cabinet with Four Doors and Cubbies</b> 	16	84	42	279	40	<b>WV1684SOC</b>	\$3,108	\$3,419
	16	78	42	264	37	<b>WV1678SOC</b>	\$2,864	\$3,150
	16	72	42	248	34	<b>WV1672SOC</b>	\$2,636	\$2,900
	16	66	42	234	32	<b>WV1666SOC</b>	\$2,494	\$2,744
	16	60	42	218	29	<b>WV1660SOC</b>	\$2,360	\$2,596
	16	54	42	198	26	<b>WV1654SOC</b>	\$2,250	\$2,475

- grommets in bottom left and right and in top center of back panel
- tackboards available, see pages 310-313 or 324-327
- task lights available, see page 412
- locking doors available, specify and add \$210 list
- 19" vertical clearance from desk top to bottom of light soffit
- no pulls

<b>Storage Overhead Cabinet with Three Doors and Cubbies</b> 	16	48	42	174	23	<b>WV1648SOCR</b>	\$2,155	\$2,371
	16	48	42	174	23	<b>WV1648SOCL</b>	\$2,155	\$2,371
	16	42	42	153	21	<b>WV1642SOCR</b>	\$2,070	\$2,278
	16	42	42	153	21	<b>WV1642SOCL</b>	\$2,070	\$2,278

- grommets in bottom left and right and in top center of back panel
- tackboards available, see pages 310-313 or 324-327
- task lights available, see page 412
- locking doors available, specify and add \$210 list
- 19" vertical clearance from desk top to bottom of light soffit
- no pulls

**To Order, Specify:**

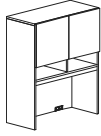
- ① Model Number
- ② Wood Species - Cherry (CH1), Maple (MA1), Walnut (WA1) or Double Cut (see page 228)
- ③ Finish Color (see page 229)
- ④ Glass Option/Color (see page 237)
- ⑤ Grommet Color - Matte Black (MBK) or Stardust Silver (STS) (see page 234)
- ⑥ Other Product Options (see page 229)

When ordering Quickship products, place a "Q" in front of model number.  
Example: QVV3072DD

**NOW!**  
*Need it.*  
JSI Quickship

Description	D	W	H	CTN WT	CU FT	① Model	Flat Cut List Price	Double Cut List Price
Storage Overhead Cabinet with Two Doors and Cubbies	16	36	42	130	18	<b>VV1636SOC</b>	\$1,991	\$2,191
	16	30	42	114	15	<b>VV1630SOC</b>	\$1,931	\$2,125

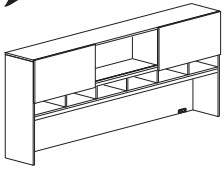
**NOW!**



- grommets in bottom left and right and in top center of back panel
- tackboards available, see pages 310-313 or 324-327
- task lights available, see page 412
- locking doors available, specify and add \$105 list
- 19" vertical clearance from desk top to bottom of light soffit
- no pulls

Storage Overhead Cabinet with Two Sliding Doors and Cubbies	16	108	42	372	51	<b>VV16108SDC</b>	\$4,512	\$4,964
	16	102	42	352	48	<b>VV16102SDC</b>	\$4,210	\$4,631
	16	96	42	331	45	<b>VV1696SDC</b>	\$3,921	\$4,314
	16	90	42	311	43	<b>VV1690SDC</b>	\$3,639	\$4,003

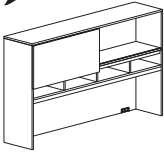
**NOW!**



- grommets in bottom left and right and in top center of back panel
- tackboards available, see pages 310-313 or 324-327
- task lights available, see page 412
- 19" vertical clearance from desk top to bottom of light soffit
- white markerboard door available, specify and add \$326 list
- locking doors not available
- pulls not available

Storage Overhead Cabinet with Sliding Door and Cubbies	16	84	42	279	40	<b>VV1684SDC</b>	\$3,275	\$3,603
	16	78	42	264	37	<b>VV1678SDC</b>	\$3,078	\$3,387
	16	72	42	248	34	<b>VV1672SDC</b>	\$2,858	\$3,144
	16	66	42	234	32	<b>VV1666SDC</b>	\$2,743	\$3,018
	16	60	42	218	29	<b>VV1660SDC</b>	\$2,635	\$2,898
	16	54	42	198	26	<b>VV1654SDC</b>	\$2,546	\$2,801

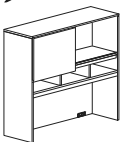
**NOW!**



- grommets in bottom left and right and in top center of back panel
- tackboards available, see pages 310-313 or 324-327
- task lights available, see page 412
- 19" vertical clearance from desk top to bottom of light soffit
- white markerboard door available, specify and add \$163 list
- locking doors not available
- pulls not available

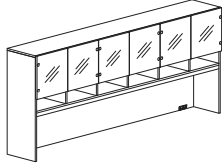
Storage Overhead Cabinet with Sliding Door and Cubbies	16	48	42	174	23	<b>VV1648SDC</b>	\$2,399	\$2,639
	16	42	42	153	21	<b>VV1642SDC</b>	\$2,331	\$2,565
	16	36	42	130	18	<b>VV1636SDC</b>	\$2,221	\$2,444
	16	30	42	114	15	<b>VV1630SDC</b>	\$2,104	\$2,315

**NOW!**



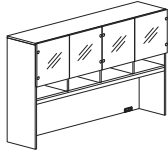
- grommets in bottom left and right and in top center of back panel
- tackboards available, see pages 310-313 or 324-327
- task lights available, see page 412
- 19" vertical clearance from desk top to bottom of light soffit
- white markerboard door available, specify and add \$163 list
- locking doors not available
- pulls not available

Description	D	W	H	CTN WT	CU FT	① Model	Flat Cut List		Double Cut List	
							Frameless	Aluminum Frame	Frameless	Aluminum Frame
Storage Overhead Cabinet with Six Glass Doors and Cubbies	16	108	42	372	51	WV16108GSOC	\$4,396	\$5,268	\$4,836	\$5,795
	16	102	42	352	48	WV16102GSOC	\$4,144	\$5,004	\$4,559	\$5,505
	16	96	42	331	45	WV1696GSOC	\$3,904	\$4,744	\$4,295	\$5,219
	16	90	42	311	43	WV1690GSOC	\$3,756	\$4,582	\$4,132	\$5,040



- select Frosted Frameless, Frosted with Aluminum Frame or White Back Painted with Aluminum Frame
- grommets in bottom left and right and in top center of back panel
- tackboards available, see pages 310-313 or 324-327
- task lights available, see page 412
- 19" vertical clearance from desk top to bottom of light soffit
- locking doors not available
- pulls not available

Storage Overhead Cabinet with Four Glass Doors and Cubbies	16	84	42	279	40	WV1684GSOC	\$3,419	\$4,036	\$3,762	\$4,440
	16	78	42	264	37	WV1678GSOC	\$3,150	\$3,738	\$3,465	\$4,112
	16	72	42	248	34	WV1672GSOC	\$2,900	\$3,481	\$3,190	\$3,830
	16	66	42	234	32	WV1666GSOC	\$2,743	\$3,310	\$3,018	\$3,642
	16	60	42	218	29	WV1660GSOC	\$2,596	\$3,146	\$2,856	\$3,461
	16	54	42	198	26	WV1654GSOC	\$2,474	\$3,010	\$2,722	\$3,311



- select Frosted Frameless, Frosted with Aluminum Frame or White Back Painted with Aluminum Frame
- grommets in bottom left and right and in top center of back panel
- tackboards available, see pages 310-313 or 324-327
- task lights available, see page 412
- 19" vertical clearance from desk top to bottom of light soffit
- locking doors not available
- pulls not available

Storage Overhead Cabinet with Three Glass Doors and Cubbies	16	48	42	174	23	WV1648GSOCR	\$2,370	\$2,791	\$2,608	\$3,071
	16	48	42	174	23	WV1648GSOCL	\$2,370	\$2,791	\$2,608	\$3,071
	16	42	42	153	21	WV1642GSOCR	\$2,277	\$2,679	\$2,505	\$2,948
	16	42	42	153	21	WV1642GSOCL	\$2,277	\$2,679	\$2,505	\$2,948



- select Frosted Frameless, Frosted with Aluminum Frame or White Back Painted with Aluminum Frame
- grommets in bottom left and right and in top center of back panel
- tackboards available, see pages 310-313 or 324-327
- task lights available, see page 412
- 19" vertical clearance from desk top to bottom of light soffit
- locking doors not available
- pulls not available

**To Order, Specify:**

- ① Model Number
- ② Wood Species - Cherry (CH1), Maple (MA1), Walnut (WA1) or Double Cut (see page 228)
- ③ Finish Color (see page 229)
- ④ Glass Option/Color (see page 237)
- ⑤ Grommet Color - Matte Black (MBK) or Stardust Silver (STS) (see page 234)
- ⑥ Other Product Options (see page 229)

When ordering Quickship products, place a "Q" in front of model number.  
Example: QVV3072DD

**NOW!**  
Need it.  
JSI Quickship

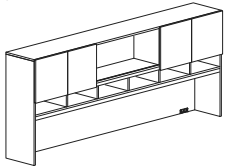


Description	D	W	H	CTN WT	CU FT	① Model	Flat Cut List		Double Cut List	
							Frameless	Aluminum Frame	Frameless	Aluminum Frame
Storage Overhead Cabinet with Two Glass Doors and Cubbies	16	36	42	130	18	<b>WV1636GSOC</b>	\$2,111	\$2,403	\$2,322	\$2,643
	16	30	42	114	15	<b>WV1630GSOC</b>	\$2,016	\$2,293	\$2,218	\$2,523



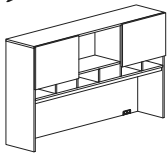
- select Frosted Frameless, Frosted with Aluminum Frame or White Back Painted with Aluminum Frame
- grommets in bottom left and right and in top center of back panel
- tackboards available, see pages 310-313 or 324-327
- task lights available, see page 412
- 19" vertical clearance from desk top to bottom of light soffit
- locking doors not available
- pulls not available

Description	D	W	H	CTN WT	CU FT	① Model	Flat Cut List Price	Double Cut List Price
<b>Now!</b>	16	102	42	299	48	<b>WV16102SMOC</b>	\$3,877	\$4,266
	16	96	42	281	45	<b>WV1696SMOC</b>	\$3,646	\$4,011
	16	90	42	263	43	<b>WV1690SMOC</b>	\$3,307	\$3,638



- grommets in bottom left and right and in top center of back panel
- tackboards available, see pages 310-313 or 324-327
- task lights available, see page 412
- locking doors available, specify and add \$210 list
- 19" vertical clearance from desk top to bottom of light soffit
- no pulls

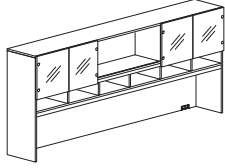
Storage Overhead Cabinet with Two Doors, Open Center Shelf and Cubbies	16	84	42	234	40	<b>WV1684SMOC</b>	\$3,000	\$3,301
	16	78	42	221	37	<b>WV1678SMOC</b>	\$2,756	\$3,032
	16	72	42	208	34	<b>WV1672SMOC</b>	\$2,528	\$2,781
	16	66	42	196	32	<b>WV1666SMOC</b>	\$2,386	\$2,625
	16	60	42	183	29	<b>WV1660SMOC</b>	\$2,252	\$2,477
	16	54	42	165	26	<b>WV1654SMOC</b>	\$2,141	\$2,356



- grommets in bottom left and right and in top center of back panel
- tackboards available, see pages 310-313 or 324-327
- task lights available, see page 412
- locking doors available, specify and add \$210 list
- 19" vertical clearance from desk top to bottom of light soffit
- no pulls

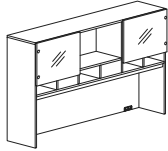
VISION - VENEER

Description	D	W	H	CTN WT	CU FT	① Model	Flat Cut List		Double Cut List	
							Frameless	Aluminum Frame	Frameless	Aluminum Frame
Storage Overhead Cabinet with Four Glass Doors, Open Center Shelf and Cubbies	16	108	42	317	51	WV16108GSMOC	\$4,204	\$4,790	\$4,625	\$5,269
	16	102	42	299	48	WV16102GSMOC	\$3,952	\$4,528	\$4,347	\$4,982
	16	96	42	281	45	WV1696GSMOC	\$3,712	\$4,276	\$4,084	\$4,704
	16	90	42	263	43	WV1690GSMOC	\$3,564	\$4,119	\$3,921	\$4,531



- select Frosted Frameless, Frosted with Aluminum Frame or White Back Painted with Aluminum Frame
- grommets in bottom left and right and in top center of back panel
- tackboards available, see pages 310-313 or 324-327
- task lights available, see page 412
- 19" vertical clearance from desk top to bottom of light soffit
- locking doors not available
- pulls not available

Storage Overhead Cabinet with Two Glass Doors, Open Center Shelf and Cubbies	16	84	42	234	40	WV1684GSMOC	\$3,227	\$3,536	\$3,551	\$3,890
	16	78	42	221	37	WV1678GSMOC	\$2,958	\$3,253	\$3,254	\$3,579
	16	72	42	208	34	WV1672GSMOC	\$2,707	\$2,999	\$2,978	\$3,300
	16	66	42	196	32	WV1666GSMOC	\$2,551	\$2,834	\$2,806	\$3,118
	16	60	42	183	29	WV1660GSMOC	\$2,404	\$2,680	\$2,644	\$2,949
	16	54	42	165	26	WV1654GSMOC	\$2,282	\$2,550	\$2,511	\$2,805



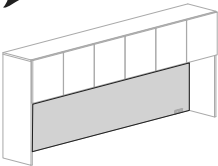
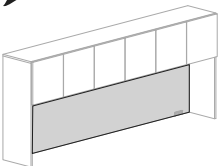
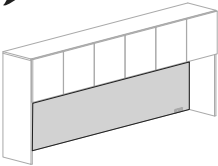
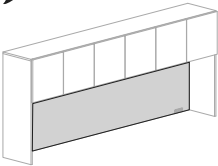
- select Frosted Frameless, Frosted with Aluminum Frame or White Back Painted with Aluminum Frame
- grommets in bottom left and right and in top center of back panel
- tackboards available, see pages 310-313 or 324-327
- task lights available, see page 412
- 19" vertical clearance from desk top to bottom of light soffit
- locking doors not available
- pulls not available

**To Order, Specify:**

- ① Model Number
- ② Wood Species - Cherry (CH1), Maple (MA1), Walnut (WA1) or Double Cut (see page 228)
- ③ Finish Color (see page 229)
- ④ Glass Option/Color (see page 237)
- ⑤ Grommet Color - Matte Black (MBK) or Stardust Silver (STS) (see page 234)
- ⑥ Other Product Options (see page 229)

When ordering Quickship products, place a "Q" in front of model number.  
Example: QV3072DD



Description	D	W	H	CTN WT	CU FT	① Model	List Price Per Grade
<b>Tackboard for Front of 108" w Storage Overhead Cabinet</b> 	3/8	106 1/8	19	14	9	VS108TK	COM \$356
							A \$389
							B \$452
							C \$563
							D \$706
							E \$850
							F \$1,071
							G \$1,310
							H \$1,564
							I \$1,961
J \$2,438							
<b>Tackboard for Front of 102" w Storage Overhead Cabinet</b> 	3/8	100 1/8	19	13	9	VS102TK	COM \$354
							A \$387
							B \$450
							C \$561
							D \$704
							E \$848
							F \$1,069
							G \$1,308
							H \$1,562
							I \$1,959
J \$2,435							
<b>Tackboard for Front of 96" w Storage Overhead Cabinet</b> 	3/8	94 1/8	19	12	8	VS96TK	COM \$340
							A \$370
							B \$428
							C \$531
							D \$663
							E \$794
							F \$1,000
							G \$1,220
							H \$1,455
							I \$1,821
J \$2,261							
<b>Tackboard for Front of 90" w Storage Overhead Cabinet</b> 	3/8	88 1/8	19	11	8	VS90TK	COM \$336
							A \$367
							B \$425
							C \$528
							D \$660
							E \$791
							F \$997
							G \$1,216
							H \$1,452
							I \$1,818
J \$2,258							

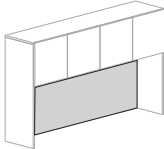
- for use with 108" overhead
- Culp Montgomery Sterling panel fabric standard, use Grade A pricing
- other fabrics available, contact customer service
- attaches with covered button screws
- ships attached when ordered with overhead cabinets
- com ydg: 3 1/4

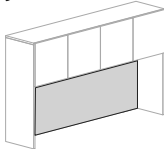
- for use with 102" overhead
- Culp Montgomery Sterling panel fabric standard, use Grade A pricing
- other fabrics available, contact customer service
- attaches with covered button screws
- ships attached when ordered with overhead cabinets
- com ydg: 3 1/4

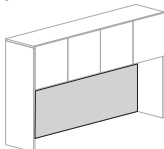
- for use with 96" overhead
- Culp Montgomery Sterling panel fabric standard, use Grade A pricing
- other fabrics available, contact customer service
- attaches with covered button screws
- ships attached when ordered with overhead cabinets
- com ydg: 3

- for use with 90" overhead
- Culp Montgomery Sterling panel fabric standard, use Grade A pricing
- other fabrics available, contact customer service
- attaches with covered button screws
- ships attached when ordered with overhead cabinets
- com ydg: 3

VISION - VENEER

Description	D	W	H	CTN WT	CU FT	① Model	List Price Per Grade
<b>Tackboard for Front of 84" w Storage Overhead Cabinet</b>	3/8	82 1/8	19	10	7	<b>VS84TK</b>	<b>COM \$294</b>
 <ul style="list-style-type: none"> <li>· for use with 84" overhead</li> <li>· Culp Montgomery Sterling panel fabric standard, use Grade A pricing</li> <li>· other fabrics available, contact customer service</li> <li>· attaches with covered button screws</li> <li>· ships attached when ordered with overhead cabinets</li> <li>· com ydg: 2 3/4</li> </ul>	A						\$322
	B						\$375
	C						\$470
	D						\$591
	E						\$711
	F						\$900
	G						\$1,102
	H						\$1,316
	I						\$1,652
	J						\$2,055

<b>Tackboard for Front of 78" w Storage Overhead Cabinet</b>	3/8	76 1/8	19	9	7	<b>VS78TK</b>	<b>COM \$290</b>
 <ul style="list-style-type: none"> <li>· for use with 78" overhead</li> <li>· Culp Montgomery Sterling panel fabric standard, use Grade A pricing</li> <li>· other fabrics available, contact customer service</li> <li>· attaches with covered button screws</li> <li>· ships attached when ordered with overhead cabinets</li> <li>· com ydg: 2 1/2</li> </ul>	A						\$315
	B						\$364
	C						\$450
	D						\$560
	E						\$669
	F						\$840
	G						\$1,024
	H						\$1,220
	I						\$1,525
	J						\$1,892

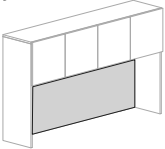
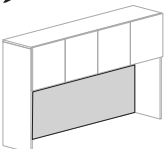
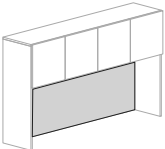
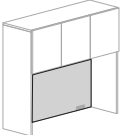
<b>Tackboard for Front of 72" w Storage Overhead Cabinet</b>	3/8	70 1/8	19	8	6	<b>VS72TK</b>	<b>COM \$272</b>
 <ul style="list-style-type: none"> <li>· for use with 72" overhead</li> <li>· Culp Montgomery Sterling panel fabric standard, use Grade A pricing</li> <li>· other fabrics available, contact customer service</li> <li>· attaches with covered button screws</li> <li>· ships attached when ordered with overhead cabinets</li> <li>· com ydg: 2 1/4</li> </ul>	A						\$296
	B						\$339
	C						\$416
	D						\$515
	E						\$614
	F						\$768
	G						\$933
	H						\$1,108
	I						\$1,383
	J						\$1,713

**To Order, Specify:**

- ① Model Number
- ② Fabric Selection: vendor, pattern, color

When ordering Quickship products, place a "Q" in front of model number.  
Example: QVW3072DD

**NOW!**  
*Need it.*  
JSI Quickship

Description	D	W	H	CTN WT	CU FT	① Model	List Price Per Grade
<b>Tackboard for Front of 66" w Storage Overhead Cabinet</b> 	3/8	64 1/8	19	8	6	VS66TK	COM \$255
							A \$275
							B \$313
							C \$383
							D \$470
							E \$558
							F \$695
							G \$842
							H \$998
							I \$1,243
J \$1,536							
<b>Tackboard for Front of 60" w Storage Overhead Cabinet</b> 	3/8	58 1/8	19	7	5	VS60TK	COM \$249
							A \$269
							B \$308
							C \$377
							D \$465
							E \$553
							F \$689
							G \$836
							H \$993
							I \$1,237
J \$1,530							
<b>Tackboard for Front of 54" w Storage Overhead Cabinet</b> 	3/8	52 1/8	19	7	5	VS54TK	COM \$231
							A \$249
							B \$283
							C \$343
							D \$420
							E \$497
							F \$617
							G \$745
							H \$882
							I \$1,096
J \$1,352							
<b>Tackboard for Front of 48" w Storage Overhead Cabinet</b> 	3/8	46 1/8	19	7	4	VS48TK	COM \$227
							A \$245
							B \$279
							C \$339
							D \$416
							E \$493
							F \$613
							G \$741
							H \$878
							I \$1,091
J \$1,348							

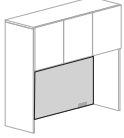
- for use with 66" overhead
- Culp Montgomery Sterling panel fabric standard, use Grade A pricing
- other fabrics available, contact customer service
- attaches with covered button screws
- ships attached when ordered with overhead cabinets
- com ydg: 2

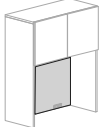
- for use with 60" overhead
- Culp Montgomery Sterling panel fabric standard, use Grade A pricing
- other fabrics available, contact customer service
- attaches with covered button screws
- ships attached when ordered with overhead cabinets
- com ydg: 2

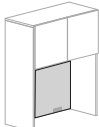
- for use with 54" overhead
- Culp Montgomery Sterling panel fabric standard, use Grade A pricing
- other fabrics available, contact customer service
- attaches with covered button screws
- ships attached when ordered with overhead cabinets
- com ydg: 1 3/4

- for use with 48" overhead
- Culp Montgomery Sterling panel fabric standard, use Grade A pricing
- other fabrics available, contact customer service
- attaches with covered button screws
- ships attached when ordered with overhead cabinets
- com ydg: 1 3/4

VISION - VENEER

Description	D	W	H	CTN WT	CU FT	① Model	List Price Per Grade
<b>Tackboard for Front of 42" w Storage Overhead Cabinet</b>	3/8	40 1/8	19	6	4	<b>VS42TK</b>	<b>COM \$209</b>
 <ul style="list-style-type: none"> <li>· for use with 42" overhead</li> <li>· Culp Montgomery Sterling panel fabric standard, use Grade A pricing</li> <li>· other fabrics available, contact customer service</li> <li>· attaches with covered button screws</li> <li>· ships attached when ordered with overhead cabinets</li> <li>· com ydg: 1 1/2</li> </ul>	A						\$225
	B						\$254
	C						\$305
	D						\$371
	E						\$437
	F						\$540
	G						\$649
	H						\$767
	I						\$951
	J						\$1,170

<b>Tackboard for Front of 36" w Storage Overhead Cabinet</b>	3/8	34 1/8	19	5	3	<b>VS36TK</b>	<b>COM \$188</b>
 <ul style="list-style-type: none"> <li>· for use with 36" overhead</li> <li>· Culp Montgomery Sterling panel fabric standard, use Grade A pricing</li> <li>· other fabrics available, contact customer service</li> <li>· attaches with covered button screws</li> <li>· ships attached when ordered with overhead cabinets</li> <li>· com ydg: 1 1/4</li> </ul>	A						\$201
	B						\$225
	C						\$268
	D						\$324
	E						\$378
	F						\$464
	G						\$556
	H						\$654
	I						\$806
	J						\$990

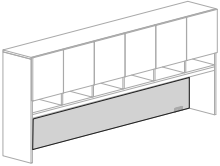
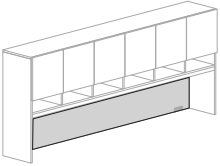
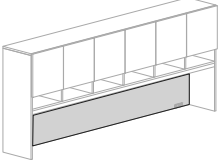
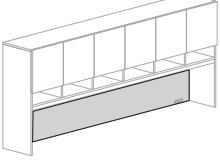
<b>Tackboard for Front of 30" w Storage Overhead Cabinet</b>	3/8	28 1/8	19	5	2	<b>VS30TK</b>	<b>COM \$168</b>
 <ul style="list-style-type: none"> <li>· for use with 30" overhead</li> <li>· Culp Montgomery Sterling panel fabric standard, use Grade A pricing</li> <li>· other fabrics available, contact customer service</li> <li>· attaches with covered button screws</li> <li>· ships attached when ordered with overhead cabinets</li> <li>· com ydg: 1 1/4</li> </ul>	A						\$181
	B						\$205
	C						\$248
	D						\$304
	E						\$359
	F						\$444
	G						\$536
	H						\$634
	I						\$786
	J						\$970

**To Order, Specify:**

- ① Model Number
- ② Fabric Selection: vendor, pattern, color

When ordering Quickship products, place a "Q" in front of model number.  
Example: QVW3072DD



Description	D	W	H	CTN WT	CU FT	① Model	List Price Per Grade
<b>Tackboard for Front of 108" w Storage Overhead Cabinet with Cubbies</b> 	3/8	106 1/8	13	14	9	VS108TKC	COM \$356
							A \$389
							B \$452
							C \$563
							D \$706
							E \$850
							F \$1,071
							G \$1,310
							H \$1,564
							I \$1,961
J \$2,438							
<b>Tackboard for Front of 102" w Storage Overhead Cabinet with Cubbies</b> 	3/8	100 1/8	13	13	9	VS102TKC	COM \$354
							A \$387
							B \$450
							C \$561
							D \$704
							E \$848
							F \$1,069
							G \$1,308
							H \$1,562
							I \$1,959
J \$2,435							
<b>Tackboard for Front of 96" w Storage Overhead Cabinet with Cubbies</b> 	3/8	94 1/8	13	12	8	VS96TKC	COM \$340
							A \$370
							B \$428
							C \$531
							D \$663
							E \$794
							F \$1,000
							G \$1,220
							H \$1,455
							I \$1,821
J \$2,261							
<b>Tackboard for Front of 90" w Storage Overhead Cabinet with Cubbies</b> 	3/8	88 1/8	13	11	8	VS90TKC	COM \$336
							A \$367
							B \$425
							C \$528
							D \$660
							E \$791
							F \$997
							G \$1,216
							H \$1,452
							I \$1,818
J \$2,258							

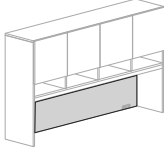
- for use with 108" overhead
- Culp Montgomery Sterling panel fabric standard, use Grade A pricing
- other fabrics available, contact customer service
- attaches with covered button screws
- ships attached when ordered with overhead cabinets
- com ydg: 3 1/4

- for use with 102" overhead
- Culp Montgomery Sterling panel fabric standard, use Grade A pricing
- other fabrics available, contact customer service
- attaches with covered button screws
- ships attached when ordered with overhead cabinets
- com ydg: 3 1/4

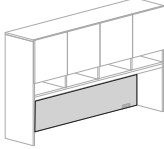
- for use with 96" overhead
- Culp Montgomery Sterling panel fabric standard, use Grade A pricing
- other fabrics available, contact customer service
- attaches with covered button screws
- ships attached when ordered with overhead cabinets
- com ydg: 3

- for use with 90" overhead
- Culp Montgomery Sterling panel fabric standard, use Grade A pricing
- other fabrics available, contact customer service
- attaches with covered button screws
- ships attached when ordered with overhead cabinets
- com ydg: 3

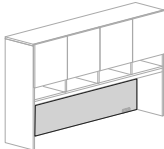
VISION - VENEER

Description	D	W	H	CTN WT	CU FT	① Model	List Price Per Grade
<b>Tackboard for Front of 84" w Storage Overhead Cabinet with Cubbies</b> 	3/8	82 1/8	13	10	7	VS84TKC	COM \$294
							A \$322
							B \$375
							C \$470
							D \$591
							E \$711
							F \$900
							G \$1,102
							H \$1,316
							I \$1,652
							J \$2,055

- for use with 84" overhead
- Culp Montgomery Sterling panel fabric standard, use Grade A pricing
- other fabrics available, contact customer service
- attaches with covered button screws
- ships attached when ordered with overhead cabinets
- com ydg: 2 3/4

<b>Tackboard for Front of 78" w Storage Overhead Cabinet with Cubbies</b> 	3/8	76 1/8	13	9	7	VS78TKC	COM \$290
							A \$315
							B \$364
							C \$450
							D \$560
							E \$669
							F \$840
							G \$1,024
							H \$1,220
							I \$1,525
							J \$1,892

- for use with 78" overhead
- Culp Montgomery Sterling panel fabric standard, use Grade A pricing
- other fabrics available, contact customer service
- attaches with covered button screws
- ships attached when ordered with overhead cabinets
- com ydg: 2 1/2

<b>Tackboard for Front of 72" w Storage Overhead Cabinet with Cubbies</b> 	3/8	70 1/8	13	8	6	VS72TKC	COM \$272
							A \$296
							B \$339
							C \$416
							D \$515
							E \$614
							F \$768
							G \$933
							H \$1,108
							I \$1,383
							J \$1,713

- for use with 72" overhead
- Culp Montgomery Sterling panel fabric standard, use Grade A pricing
- other fabrics available, contact customer service
- attaches with covered button screws
- ships attached when ordered with overhead cabinets
- com ydg: 2 1/4

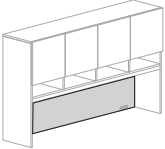
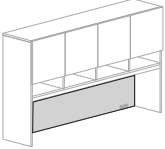
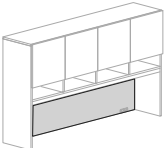
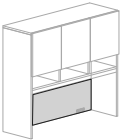
**To Order, Specify:**

- ① Model Number
- ② Fabric Selection: vendor, pattern, color

When ordering Quickship products, place a "Q" in front of model number.  
Example: QV3072DD

**NOW!**  
Need it.  
JSI Quickship



Description	D	W	H	CTN WT	CU FT	① Model	List Price Per Grade
<b>Tackboard for Front of 66" w Storage Overhead Cabinet with Cubbies</b> 	3/8	64 1/8	13	8	6	VS66TKC	COM \$255
							A \$275
							B \$313
							C \$383
							D \$470
							E \$558
							F \$695
							G \$842
							H \$998
							I \$1,243
							J \$1,536
<b>Tackboard for Front of 60" w Storage Overhead Cabinet with Cubbies</b> 	3/8	58 1/8	13	7	5	VS60TKC	COM \$249
							A \$269
							B \$308
							C \$377
							D \$465
							E \$553
							F \$689
							G \$836
							H \$993
							I \$1,237
							J \$1,530
<b>Tackboard for Front of 54" w Storage Overhead Cabinet with Cubbies</b> 	3/8	52 1/8	13	7	5	VS54TKC	COM \$231
							A \$249
							B \$283
							C \$343
							D \$420
							E \$497
							F \$617
							G \$745
							H \$882
							I \$1,096
							J \$1,352
<b>Tackboard for Front of 48" w Storage Overhead Cabinet with Cubbies</b> 	3/8	46 1/8	13	7	4	VS48TKC	COM \$227
							A \$245
							B \$279
							C \$339
							D \$416
							E \$493
							F \$613
							G \$741
							H \$878
							I \$1,091
							J \$1,348


- for use with 66" overhead
- Culp Montgomery Sterling panel fabric standard, use Grade A pricing
- other fabrics available, contact customer service
- attaches with covered button screws
- ships attached when ordered with overhead cabinets
- com ydg: 2

- for use with 60" overhead
- Culp Montgomery Sterling panel fabric standard, use Grade A pricing
- other fabrics available, contact customer service
- attaches with covered button screws
- ships attached when ordered with overhead cabinets
- com ydg: 2

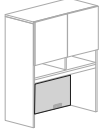
- for use with 54" overhead
- Culp Montgomery Sterling panel fabric standard, use Grade A pricing
- other fabrics available, contact customer service
- attaches with covered button screws
- ships attached when ordered with overhead cabinets
- com ydg: 1 3/4

- for use with 48" overhead
- Culp Montgomery Sterling panel fabric standard, use Grade A pricing
- other fabrics available, contact customer service
- attaches with covered button screws
- ships attached when ordered with overhead cabinets
- com ydg: 1 3/4

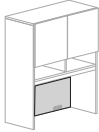
VISION - VENEER

Description	D	W	H	CTN WT	CU FT	① Model	List Price Per Grade
<b>Tackboard for Front of 42" w Storage Overhead Cabinet with Cubbies</b> 	3/8	40 1/8	13	6	4	VS42TKC	COM \$209
							A \$225
							B \$254
							C \$305
							D \$371
							E \$437
							F \$540
							G \$649
							H \$767
							I \$951
							J \$1,170

- for use with 42" overhead
- Culp Montgomery Sterling panel fabric standard, use Grade A pricing
- other fabrics available, contact customer service
- attaches with covered button screws
- ships attached when ordered with overhead cabinets
- com ydg: 1 1/2

<b>Tackboard for Front of 36" w Storage Overhead Cabinet with Cubbies</b> 	3/8	34 1/8	13	5	3	VS36TKC	COM \$188
							A \$201
							B \$225
							C \$268
							D \$324
							E \$378
							F \$464
							G \$556
							H \$654
							I \$806
							J \$990

- for use with 36" overhead
- Culp Montgomery Sterling panel fabric standard, use Grade A pricing
- other fabrics available, contact customer service
- attaches with covered button screws
- ships attached when ordered with overhead cabinets
- com ydg: 1 1/4

<b>Tackboard for Front of 30" w Storage Overhead Cabinet with Cubbies</b> 	3/8	28 1/8	13	5	2	VS30TKC	COM \$168
							A \$181
							B \$205
							C \$248
							D \$304
							E \$359
							F \$444
							G \$536
							H \$634
							I \$786
							J \$970

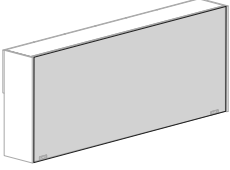
- for use with 30" overhead
- Culp Montgomery Sterling panel fabric standard, use Grade A pricing
- other fabrics available, contact customer service
- attaches with covered button screws
- ships attached when ordered with overhead cabinets
- com ydg: 1 1/4

**To Order, Specify:**

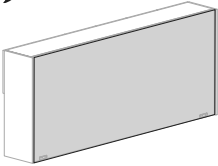
- ① Model Number
- ② Fabric Selection: vendor, pattern, color

When ordering Quickship products, place a "Q" in front of model number.  
Example: QV3072DD

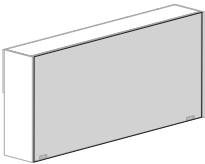
**NOW!**  
*Need it.*  
JSI Quickship

Description	D	W	H	CTN WT	CU FT	① Model	List Price Per Grade
<b>Tackboard for Back of 108" w Storage Overhead Cabinet</b> 	3/8	106	42	48	13	VS10842STB	COM \$585
							A \$618
							B \$681
							C \$792
							D \$935
							E \$1,079
							F \$1,300
							G \$1,539
							H \$1,793
							I \$2,190
							J \$2,666

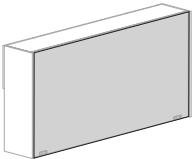
- for use with 108" wide storage overhead cabinet
- Culp Montgomery Sterling panel fabric standard, use Grade A pricing
- other fabrics available, contact customer service
- attaches with covered button screws
- ships attached when ordered with overhead cabinets
- com ydg: 3 1/4

<b>Tackboard for Back of 102" w Storage Overhead Cabinet</b> 	3/8	100	42	44	13	VS10242STB	COM \$571
							A \$603
							B \$666
							C \$777
							D \$920
							E \$1,064
							F \$1,286
							G \$1,524
							H \$1,778
							I \$2,175
							J \$2,652

- for use with 102" wide storage overhead cabinet
- Culp Montgomery Sterling panel fabric standard, use Grade A pricing
- other fabrics available, contact customer service
- attaches with covered button screws
- ships attached when ordered with overhead cabinets
- com ydg: 3 1/4

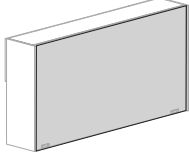
<b>Tackboard for Back of 96" w Storage Overhead Cabinet</b> 	3/8	94	42	38	12	VS9642STB	COM \$536
							A \$566
							B \$624
							C \$727
							D \$859
							E \$991
							F \$1,196
							G \$1,416
							H \$1,651
							I \$2,018
							J \$2,457

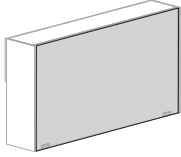
- for use with 96" wide storage overhead cabinet
- Culp Montgomery Sterling panel fabric standard, use Grade A pricing
- other fabrics available, contact customer service
- attaches with covered button screws
- ships attached when ordered with overhead cabinets
- com ydg: 3

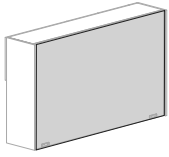
<b>Tackboard for Back of 90" w Storage Overhead Cabinet</b> 	3/8	88	42	35	11	VS9042STB	COM \$515
							A \$545
							B \$603
							C \$706
							D \$838
							E \$970
							F \$1,175
							G \$1,395
							H \$1,630
							I \$1,997
							J \$2,436

- for use with 90" wide storage overhead cabinet
- Culp Montgomery Sterling panel fabric standard, use Grade A pricing
- other fabrics available, contact customer service
- attaches with covered button screws
- ships attached when ordered with overhead cabinets
- com ydg: 3

VISION - VENEER

Description	D	W	H	CTN WT	CU FT	① Model	List Price Per Grade
<b>Tackboard for Back of 84" w Storage Overhead Cabinet</b>	3/8	82	42	33	10	<b>VS8442STB</b>	<b>COM \$437</b>
 <ul style="list-style-type: none"> <li>· for use with 84" wide storage overhead cabinet</li> <li>· Culp Montgomery Sterling panel fabric standard, use Grade A pricing</li> <li>· other fabrics available, contact customer service</li> <li>· attaches with covered button screws</li> <li>· ships attached when ordered with overhead cabinets</li> <li>· com ydg: 2 3/4</li> </ul>	A						\$465
	B						\$518
	C						\$613
	D						\$733
	E						\$854
	F						\$1,043
	G						\$1,245
	H						\$1,459
	I						\$1,795
	J						\$2,198

<b>Tackboard for Back of 78" w Storage Overhead Cabinet</b>	3/8	76	42	30	10	<b>VS7842STB</b>	<b>COM \$422</b>
 <ul style="list-style-type: none"> <li>· for use with 78" wide storage overhead cabinet</li> <li>· Culp Montgomery Sterling panel fabric standard, use Grade A pricing</li> <li>· other fabrics available, contact customer service</li> <li>· attaches with covered button screws</li> <li>· ships attached when ordered with overhead cabinets</li> <li>· com ydg: 2 1/2</li> </ul>	A						\$447
	B						\$495
	C						\$581
	D						\$691
	E						\$801
	F						\$972
	G						\$1,155
	H						\$1,351
	I						\$1,656
	J						\$2,023

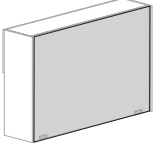
<b>Tackboard for Back of 72" w Storage Overhead Cabinet</b>	3/8	70	42	27	9	<b>VS7242STB</b>	<b>COM \$394</b>
 <ul style="list-style-type: none"> <li>· for use with 72" wide storage overhead cabinet</li> <li>· Culp Montgomery Sterling panel fabric standard, use Grade A pricing</li> <li>· other fabrics available, contact customer service</li> <li>· attaches with covered button screws</li> <li>· ships attached when ordered with overhead cabinets</li> <li>· com ydg: 2 1/4</li> </ul>	A						\$417
	B						\$460
	C						\$538
	D						\$637
	E						\$735
	F						\$890
	G						\$1,055
	H						\$1,230
	I						\$1,505
	J						\$1,835

**To Order, Specify:**

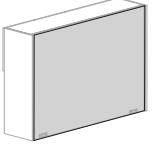
- ① Model Number
- ② Fabric Selection: vendor, pattern, color

When ordering Quickship products, place a "Q" in front of model number.  
Example: QVW3072DD

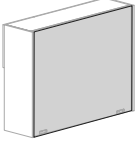
**NOW!**  
*Need it.*  
JSI Quickship

Description	D	W	H	CTN WT	CU FT	① Model	List Price Per Grade
<b>Tackboard for Back of 66" w Storage Overhead Cabinet</b> 	3/8	64	42	24	8	VS6642STB	COM \$368
							A \$388
							B \$427
							C \$496
							D \$583
							E \$671
							F \$808
							G \$955
							H \$1,111
							I \$1,356
							J \$1,649

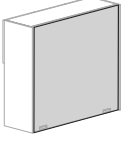
- for use with 66" wide storage overhead cabinet
- Culp Montgomery Sterling panel fabric standard, use Grade A pricing
- other fabrics available, contact customer service
- attaches with covered button screws
- ships attached when ordered with overhead cabinets
- com ydg: 2

<b>Tackboard for Back of 60" w Storage Overhead Cabinet</b> 	3/8	58	42	21	8	VS6042STB	COM \$353
							A \$373
							B \$412
							C \$481
							D \$569
							E \$657
							F \$793
							G \$940
							H \$1,097
							I \$1,341
							J \$1,634

- for use with 60" wide storage overhead cabinet
- Culp Montgomery Sterling panel fabric standard, use Grade A pricing
- other fabrics available, contact customer service
- attaches with covered button screws
- ships attached when ordered with overhead cabinets
- com ydg: 2

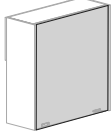
<b>Tackboard for Back of 54" w Storage Overhead Cabinet</b> 	3/8	52	42	18	7	VS5442STB	COM \$324
							A \$342
							B \$375
							C \$435
							D \$513
							E \$590
							F \$709
							G \$837
							H \$975
							I \$1,188
							J \$1,444

- for use with 54" wide storage overhead cabinet
- Culp Montgomery Sterling panel fabric standard, use Grade A pricing
- other fabrics available, contact customer service
- attaches with covered button screws
- ships attached when ordered with overhead cabinets
- com ydg: 1 3/4

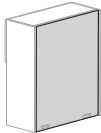
<b>Tackboard for Back of 48" w Storage Overhead Cabinet</b> 	3/8	46	42	15	6	VS4842STB	COM \$313
							A \$331
							B \$365
							C \$425
							D \$502
							E \$579
							F \$699
							G \$827
							H \$964
							I \$1,178
							J \$1,434

- for use with 48" wide storage overhead cabinet
- Culp Montgomery Sterling panel fabric standard, use Grade A pricing
- other fabrics available, contact customer service
- attaches with covered button screws
- ships attached when ordered with overhead cabinets
- com ydg: 1 3/4

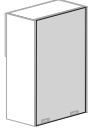
VISION - VENEER

Description	D	W	H	CTN WT	CU FT	① Model	List Price Per Grade
<b>Tackboard for Back of 42" w Storage Overhead Cabinet</b> 	3/8	40	42	12	5	VS4242STB	COM \$287
							A \$303
							B \$331
							C \$383
							D \$449
							E \$515
							F \$618
							G \$727
							H \$845
							I \$1,028
J \$1,248							

- for use with 42" wide storage overhead cabinet
- Culp Montgomery Sterling panel fabric standard, use Grade A pricing
- other fabrics available, contact customer service
- attaches with covered button screws
- ships attached when ordered with overhead cabinets
- com ydg: 1 1/2

<b>Tackboard for Back of 36" w Storage Overhead Cabinet</b> 	3/8	34	42	8	5	VS3642STB	COM \$258
							A \$270
							B \$294
							C \$338
							D \$393
							E \$448
							F \$533
							G \$625
							H \$723
							I \$875
J \$1,059							

- for use with 36" wide storage overhead cabinet
- Culp Montgomery Sterling panel fabric standard, use Grade A pricing
- other fabrics available, contact customer service
- attaches with covered button screws
- ships attached when ordered with overhead cabinets
- com ydg: 1 1/4

<b>Tackboard for Back of 30" w Storage Overhead Cabinet</b> 	3/8	28	42	7	4	VS3042STB	COM \$230
							A \$243
							B \$267
							C \$310
							D \$366
							E \$420
							F \$506
							G \$598
							H \$696
							I \$848
J \$1,032							

- for use with 30" wide storage overhead cabinet
- Culp Montgomery Sterling panel fabric standard, use Grade A pricing
- other fabrics available, contact customer service
- attaches with covered button screws
- ships attached when ordered with overhead cabinets
- com ydg: 1 1/4



**To Order, Specify:**

- ① Model Number
- ② Fabric Selection: vendor, pattern, color

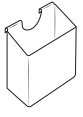

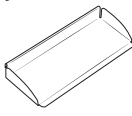
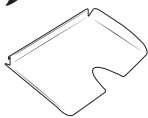
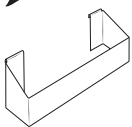
When ordering Quickship products, place a "Q" in front of model number.  
Example: QVV3072DD



VISION - VENEER

Description	D	W	H	CTN WT	CU FT	① Model	List Price
Accessory Rail	3/4	106 1/8	3 1/4	9	3	VS108AR	\$367
	3/4	100 1/8	3 1/4	8	3	VS102AR	\$352
	3/4	94 1/8	3 1/4	7	3	VS96AR	\$324
	3/4	88 1/8	3 1/4	7	3	VS90AR	\$308
	3/4	82 1/8	3 1/4	6	2	VS84AR	\$293
	3/4	76 1/8	3 1/4	6	2	VS78AR	\$279
	3/4	70 1/8	3 1/4	5	2	VS72AR	\$265
	3/4	64 1/8	3 1/4	4	2	VS66AR	\$250
	3/4	58 1/8	3 1/4	4	2	VS60AR	\$236
	3/4	52 1/8	3 1/4	4	2	VS54AR	\$221
	3/4	46 1/8	3 1/4	3	2	VS48AR	\$207
	3/4	40 1/8	3 1/4	3	1	VS42AR	\$194
	3/4	34 1/8	3 1/4	3	1	VS36AR	\$178
	3/4	28 1/8	3 1/4	2	1	VS30AR	\$164

VISION - VENEER

Description	D	W	H	CTN WT	CU FT	① Model	List Price
<b>Upright Tray</b>  <ul style="list-style-type: none"> <li>pen and gadget cup</li> <li>Stardust Silver finish</li> </ul>	1 9/16	3 1/8	3 9/16	1	1	AC203CUP	\$75 <sup>▲</sup>
<b>Small Tray</b>  <ul style="list-style-type: none"> <li>tray for paper clips and other small items</li> <li>Stardust Silver finish</li> </ul>	3 5/16	2 11/16	7/8	1	1	AC403TRAY	\$56 <sup>▲</sup>
<b>Pencil Tray</b>  <ul style="list-style-type: none"> <li>tray for pencils and other small items</li> <li>Stardust Silver finish</li> </ul>	3 5/16	7 11/16	7/8	1	1	AC408TRAY	\$69 <sup>▲</sup>
<b>Paper Tray</b>  <ul style="list-style-type: none"> <li>tray for 8 1/2 x 11" letter paper size</li> <li>Stardust Silver finish</li> </ul>	9 15/16	13 3/16	7/8	2	1	AC912PAP	\$107 <sup>▲</sup>
<b>File Hanger</b>  <ul style="list-style-type: none"> <li>file hanger for 8 1/2 x 11" letter size hanging file folders</li> <li>Stardust Silver finish</li> </ul>	2 13/16	12 3/16	4	1	1	AC313FILE	\$101 <sup>▲</sup>

VISION - VENEER

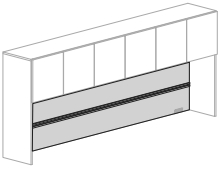
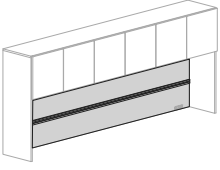
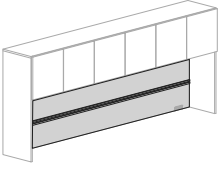
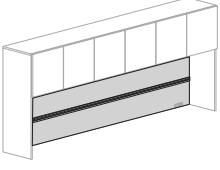
**To Order, Specify:**

① Model Number

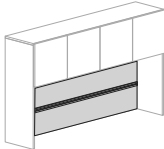
When ordering Quickship products, place a "Q" in front of model number.  
 Example: QVV3072DD

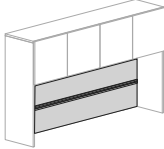
**NOW!**  
*Need it.*  
 JSI Quickship

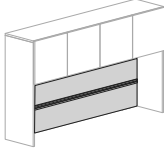


Description	D	W	H	CTN WT	CU FT	① Model	List Price Per Grade
<b>Tackboard for Accessory Rail of 108" w Storage Overhead Cabinet</b> 	3/8	106 1/8		14	9	VS108TKA	COM \$389
							A \$422
							B \$485
							C \$596
							D \$739
							E \$882
							F \$1,104
							G \$1,342
							H \$1,596
							I \$1,993
							J \$2,470
							<ul style="list-style-type: none"> <li>tackboard panels for above and below accessory rail</li> <li>not required; add-on for convenience application</li> <li>Culp Montgomery Sterling panel fabric standard, use Grade A pricing</li> <li>other fabrics available, contact Customer Service</li> <li>com ydg: 3 1/4</li> <li>upper tackboard height: 8 1/4"</li> <li>lower tackboard height: 7 1/2"</li> <li>coordinates with WV16108DGSO, WV16108GSO, WV16108DSO, WV16108SO, WV16108DSD and WV16108SD</li> <li>accessory rail sold separately, see page 318</li> </ul>
							<b>Tackboard for Accessory Rail of 102" w Storage Overhead Cabinet</b> 
A \$419							
B \$482							
C \$594							
D \$737							
E \$880							
F \$1,102							
G \$1,340							
H \$1,594							
I \$1,991							
J \$2,468							
<ul style="list-style-type: none"> <li>tackboard panels for above and below accessory rail</li> <li>not required; add-on for convenience application</li> <li>Culp Montgomery Sterling panel fabric standard, use Grade A pricing</li> <li>other fabrics available, contact Customer Service</li> <li>com ydg: 3 1/4</li> <li>upper tackboard height: 8 1/4"</li> <li>lower tackboard height: 7 1/2"</li> <li>coordinates with WV16102DGSO, WV16102GSO, WV16102DSO, WV16102SO, WV16102DSD and WV16102SD</li> <li>accessory rail sold separately, see page 318</li> </ul>							
<b>Tackboard for Accessory Rail of 96" w Storage Overhead Cabinet</b> 	3/8	94 1/8		12	8	VS96TKA	
							A \$403
							B \$460
							C \$563
							D \$696
							E \$827
							F \$1,033
							G \$1,252
							H \$1,487
							I \$1,854
							J \$2,294
							<ul style="list-style-type: none"> <li>tackboard panels for above and below accessory rail</li> <li>not required; add-on for convenience application</li> <li>Culp Montgomery Sterling panel fabric standard, use Grade A pricing</li> <li>other fabrics available, contact Customer Service</li> <li>com ydg: 3</li> <li>upper tackboard height: 8 1/4"</li> <li>lower tackboard height: 7 1/2"</li> <li>coordinates with WV1696DGSO, WV1696GSO, WV1696DSO, WV1696SO, WV1696DSD and WV1696SD</li> <li>accessory rail sold separately, see page 318</li> </ul>
							<b>Tackboard for Accessory Rail of 90" w Storage Overhead Cabinet</b> 
A \$399							
B \$457							
C \$560							
D \$692							
E \$824							
F \$1,029							
G \$1,249							
H \$1,484							
I \$1,851							
J \$2,291							
<ul style="list-style-type: none"> <li>tackboard panels for above and below accessory rail</li> <li>not required; add-on for convenience application</li> <li>Culp Montgomery Sterling panel fabric standard, use Grade A pricing</li> <li>other fabrics available, contact Customer Service</li> <li>com ydg: 3</li> <li>upper tackboard height: 8 1/4"</li> <li>lower tackboard height: 7 1/2"</li> <li>coordinates with WV1690DGSO, WV1690GSO, WV1690DSO, WV1690SO, WV1690DSD and WV1690SD</li> <li>accessory rail sold separately, see page 318</li> </ul>							

VISION - VENEER

Description	D	W	H	CTN WT	CU FT	① Model	List Price Per Grade
<b>Tackboard for Accessory Rail of 84" w Storage Overhead Cabinet</b> 	3/8	82 1/8		10	7	VS84TKA	COM \$327
							A \$354
							B \$408
							C \$502
							D \$623
							E \$744
							F \$933
							G \$1,134
							H \$1,349
							I \$1,685
J \$2,088							

<b>Tackboard for Accessory Rail of 78" w Storage Overhead Cabinet</b> 	3/8	76 1/8		9	7	VS78TKA	COM \$322
							A \$347
							B \$395
							C \$481
							D \$592
							E \$701
							F \$872
							G \$1,056
							H \$1,251
							I \$1,557
J \$1,923							

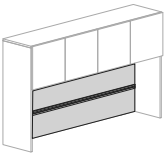

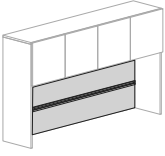

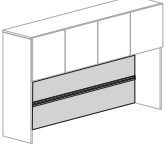

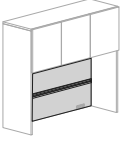

<b>Tackboard for Accessory Rail of 72" w Storage Overhead Cabinet</b> 	3/8	70 1/8		8	6	VS72TKA	COM \$305
							A \$328
							B \$371
							C \$449
							D \$548
							E \$646
							F \$801
							G \$965
							H \$1,141
							I \$1,416
J \$1,746							

**To Order, Specify:**

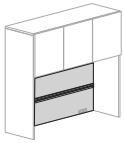
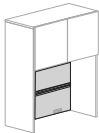
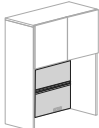
- ① Model Number
- ② Fabric Selection: vendor, pattern, color

When ordering Quickship products, place a "Q" in front of model number.  
 Example: QVW3072DD



Description	D	W	H	CTN WT	CU FT	① Model	List Price Per Grade	
<b>Tackboard for Accessory Rail of 66" w Storage Overhead Cabinet</b> 	3/8	64 1/8		8	6	VS66TKA	COM \$286	
							A \$306	
							B \$345	
							C \$414	
							D \$501	
							E \$590	
							F \$726	
							G \$873	
							H \$1,029	
							I \$1,274	
J \$1,567								
	<ul style="list-style-type: none"> <li>tackboard panels for above and below accessory rail</li> <li>not required; add-on for convenience application</li> <li>Culp Montgomery Sterling panel fabric standard, use Grade A pricing</li> <li>other fabrics available, contact Customer Service</li> <li>com ydg: 2</li> <li>upper tackboard height: 8 1/4"</li> <li>lower tackboard height: 7 1/2"</li> <li>coordinates with WV1666DGSO, WV1666GSO, WV1666DSO, WV1666SO, WV1666DSD and WV1666SD</li> <li>accessory rail sold separately, see page 318</li> </ul>							
	<b>Tackboard for Accessory Rail of 60" w Storage Overhead Cabinet</b> 	3/8	58 1/8		7	5	VS60TKA	COM \$282
								A \$302
								B \$341
								C \$410
								D \$497
								E \$585
								F \$722
								G \$869
								H \$1,025
I \$1,270								
J \$1,563								
	<ul style="list-style-type: none"> <li>tackboard panels for above and below accessory rail</li> <li>not required; add-on for convenience application</li> <li>Culp Montgomery Sterling panel fabric standard, use Grade A pricing</li> <li>other fabrics available, contact Customer Service</li> <li>com ydg: 2</li> <li>upper tackboard height: 8 1/4"</li> <li>lower tackboard height: 7 1/2"</li> <li>coordinates with WV1660DGSO, WV1660GSO, WV1660DSO, WV1660SO, WV1660DSD and WV1660SD</li> <li>accessory rail sold separately, see page 318</li> </ul>							
	<b>Tackboard for Accessory Rail of 54" w Storage Overhead Cabinet</b> 	3/8	52 1/8		7	5	VS54TKA	COM \$264
								A \$282
								B \$315
								C \$375
								D \$453
								E \$530
								F \$649
								G \$777
								H \$915
I \$1,128								
J \$1,384								
	<ul style="list-style-type: none"> <li>tackboard panels for above and below accessory rail</li> <li>not required; add-on for convenience application</li> <li>Culp Montgomery Sterling panel fabric standard, use Grade A pricing</li> <li>other fabrics available, contact Customer Service</li> <li>com ydg: 1 3/4</li> <li>upper tackboard height: 8 1/4"</li> <li>lower tackboard height: 7 1/2"</li> <li>coordinates with WV1654DGSO, WV1654GSO, WV1654DSO, WV1654SO, WV1654DSD and WV1654SD</li> <li>accessory rail sold separately, see page 318</li> </ul>							
	<b>Tackboard for Accessory Rail of 48" w Storage Overhead Cabinet</b> 	3/8	46 1/8		7	4	VS48TKA	COM \$260
								A \$278
								B \$311
								C \$371
								D \$449
								E \$525
								F \$645
								G \$773
								H \$911
I \$1,124								
J \$1,380								
	<ul style="list-style-type: none"> <li>tackboard panels for above and below accessory rail</li> <li>not required; add-on for convenience application</li> <li>Culp Montgomery Sterling panel fabric standard, use Grade A pricing</li> <li>other fabrics available, contact Customer Service</li> <li>com ydg: 1 3/4</li> <li>upper tackboard height: 8 1/4"</li> <li>lower tackboard height: 7 1/2"</li> <li>coordinates with WV1648DGSO, WV1648GSO, WV1648DSO, WV1648SO, WV1648DSD and WV1648SD</li> <li>accessory rail sold separately, see page 318</li> </ul>							

VISION - VENEER

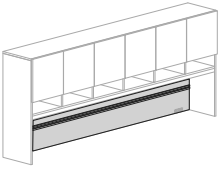
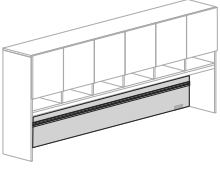
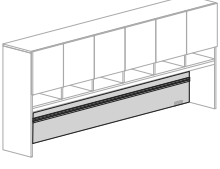
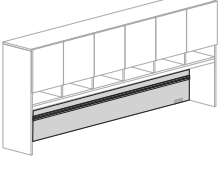
Description	D	W	H	CTN WT	CU FT	① Model	List Price Per Grade
<b>Tackboard for Accessory Rail of 42" w Storage Overhead Cabinet</b> 	3/8	40 1/8		6	4	<b>VS42TKA</b>	<b>COM \$242</b> A \$258 B \$286 C \$338 D \$404 E \$470 F \$573 G \$682 H \$800 I \$983 J \$1,203
<ul style="list-style-type: none"> <li>tackboard panels for above and below accessory rail</li> <li>not required; add-on for convenience application</li> <li>Culp Montgomery Sterling panel fabric standard, use Grade A pricing</li> <li>other fabrics available, contact Customer Service</li> <li>com ydg: 1 1/2</li> <li>upper tackboard height: 8 1/4"</li> <li>lower tackboard height: 7 1/2"</li> <li>coordinates with WV1642DGSO, WV1642GSO, WV1642DSO, WV1642SO, WV1642DSD and WV1642SD</li> <li>accessory rail sold separately, see page 318</li> </ul>							
<b>Tackboard for Accessory Rail of 36" w Storage Overhead Cabinet</b> 	3/8	34 1/8		5	3	<b>VS36TKA</b>	<b>COM \$221</b> A \$234 B \$258 C \$301 D \$356 E \$411 F \$496 G \$588 H \$686 I \$838 J \$1,022
<ul style="list-style-type: none"> <li>tackboard panels for above and below accessory rail</li> <li>not required; add-on for convenience application</li> <li>Culp Montgomery Sterling panel fabric standard, use Grade A pricing</li> <li>other fabrics available, contact Customer Service</li> <li>com ydg: 1 1/4</li> <li>upper tackboard height: 8 1/4"</li> <li>lower tackboard height: 7 1/2"</li> <li>coordinates with WV1636DGSO, WV1636GSO, WV1636DSO, WV1636SO, WV1636DSD and WV1636SD</li> <li>accessory rail sold separately, see page 318</li> </ul>							
<b>Tackboard for Accessory Rail of 30" w Storage Overhead Cabinet</b> 	3/8	28 1/8		5	2	<b>VS30TKA</b>	<b>COM \$201</b> A \$214 B \$238 C \$281 D \$336 E \$391 F \$476 G \$569 H \$666 I \$818 J \$1,002
<ul style="list-style-type: none"> <li>tackboard panels for above and below accessory rail</li> <li>not required; add-on for convenience application</li> <li>Culp Montgomery Sterling panel fabric standard, use Grade A pricing</li> <li>other fabrics available, contact Customer Service</li> <li>com ydg: 1 1/4</li> <li>upper tackboard height: 8 1/4"</li> <li>lower tackboard height: 7 1/2"</li> <li>coordinates with WV1630DGSO, WV1630GSO, WV1630DSO, WV1630SO, WV1630DSD and WV1630SD</li> <li>accessory rail sold separately, see page 318</li> </ul>							

**To Order, Specify:**

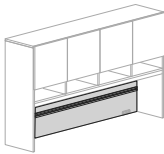
- ① Model Number
- ② Fabric Selection: vendor, pattern, color

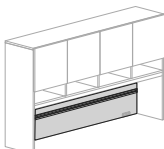
When ordering Quickship products, place a "Q" in front of model number.  
 Example: QW3072DD

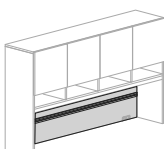


Description	D	W	H	CTN WT	CU FT	① Model	List Price Per Grade
<b>Tackboard for Accessory Rail of 108" w Storage Overhead Cabinet with Cubbies</b> 	3/8	106 1/8		14	9	VS108TKCA	COM \$389
							A \$422
							B \$485
							C \$596
							D \$739
							E \$882
							F \$1,104
							G \$1,342
							H \$1,596
							I \$1,993
J \$2,470							
<b>Tackboard for Accessory Rail of 102" w Storage Overhead Cabinet with Cubbies</b> 	3/8	100 1/8		13	9	VS102TKCA	COM \$387
							A \$419
							B \$482
							C \$594
							D \$737
							E \$880
							F \$1,102
							G \$1,340
							H \$1,594
							I \$1,991
J \$2,468							
<b>Tackboard for Accessory Rail of 96" w Storage Overhead Cabinet with Cubbies</b> 	3/8	94 1/8		12	8	VS96TKCA	COM \$372
							A \$403
							B \$460
							C \$563
							D \$696
							E \$827
							F \$1,033
							G \$1,252
							H \$1,487
							I \$1,854
J \$2,294							
<b>Tackboard for Accessory Rail of 90" w Storage Overhead Cabinet with Cubbies</b> 	3/8	88 1/8		11	8	VS90TKCA	COM \$369
							A \$399
							B \$457
							C \$560
							D \$692
							E \$824
							F \$1,029
							G \$1,249
							H \$1,484
							I \$1,851
J \$2,291							

VISION - VENEER

Description	D	W	H	CTN WT	CU FT	① Model	List Price Per Grade
<b>Tackboard for Accessory Rail of 84" w Storage Overhead Cabinet with Cubbies</b> 	3/8	82 1/8		10	7	VS84TKCA	COM \$327
							A \$354
							B \$408
							C \$502
							D \$623
							E \$744
							F \$933
							G \$1,134
							H \$1,349
							I \$1,685
J \$2,088							

<b>Tackboard for Accessory Rail of 78" w Storage Overhead Cabinet with Cubbies</b> 	3/8	76 1/8		9	7	VS78TKCA	COM \$322
							A \$347
							B \$395
							C \$481
							D \$592
							E \$701
							F \$872
							G \$1,056
							H \$1,251
							I \$1,557
J \$1,923							

<b>Tackboard for Accessory Rail of 72" w Storage Overhead Cabinet with Cubbies</b> 	3/8	70 1/8		8	6	VS72TKCA	COM \$305
							A \$328
							B \$371
							C \$449
							D \$548
							E \$646
							F \$801
							G \$965
							H \$1,141
							I \$1,416
J \$1,746							

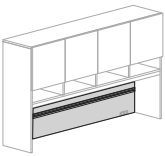
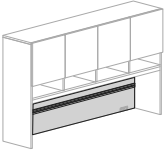
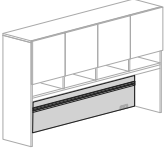

**To Order, Specify:**

- ① Model Number
- ② Fabric Selection: vendor, pattern, color


When ordering Quickship products, place a "Q" in front of model number.  
 Example: QVW3072DD


**NOW!**  
 Need it.  
 JSI Quickship


VISION - VENEER

Description	D	W	H	CTN WT	CU FT	① Model	List Price Per Grade
<b>Tackboard for Accessory Rail of 66" w Storage Overhead Cabinet with Cubbies</b> 	3/8	64 1/8		8	6	VS66TKCA	COM \$286
							A \$306
							B \$345
							C \$414
							D \$501
							E \$590
							F \$726
							G \$873
							H \$1,029
							I \$1,274
							J \$1,567
							<ul style="list-style-type: none"> <li>tackboard panels for above and below accessory rail</li> <li>not required; add-on for convenience application</li> <li>Culp Montgomery Sterling panel fabric standard, use Grade A pricing</li> <li>other fabrics available, contact Customer Service</li> <li>com ydg: 2</li> <li>upper tackboard height: 2 1/4"</li> <li>lower tackboard height: 7 1/2"</li> <li>coordinates with WV1666DGSOC, WV1666GSOC, WV1666DSOC, WV1666SOC, WV1666SDC, WV1666SMOC and WV1666GSMOC</li> <li>accessory rail sold separately, see page 318</li> </ul>
							<b>Tackboard for Accessory Rail of 60" w Storage Overhead Cabinet with Cubbies</b> 
A \$302							
B \$341							
C \$410							
D \$497							
E \$585							
F \$722							
G \$869							
H \$1,025							
I \$1,270							
J \$1,563							
<ul style="list-style-type: none"> <li>tackboard panels for above and below accessory rail</li> <li>not required; add-on for convenience application</li> <li>Culp Montgomery Sterling panel fabric standard, use Grade A pricing</li> <li>other fabrics available, contact Customer Service</li> <li>com ydg: 2</li> <li>upper tackboard height: 2 1/4"</li> <li>lower tackboard height: 7 1/2"</li> <li>coordinates with WV1660DGSOC, WV1660GSOC, WV1660DSOC, WV1660SOC, WV1660SDC, WV1660SMOC and WV1660GSMOC</li> <li>accessory rail sold separately, see page 318</li> </ul>							
<b>Tackboard for Accessory Rail of 54" w Storage Overhead Cabinet with Cubbies</b> 	3/8	52 1/8		7	5	VS54TKCA	
							A \$282
							B \$315
							C \$375
							D \$453
							E \$530
							F \$649
							G \$777
							H \$915
							I \$1,128
							J \$1,384
							<ul style="list-style-type: none"> <li>tackboard panels for above and below accessory rail</li> <li>not required; add-on for convenience application</li> <li>Culp Montgomery Sterling panel fabric standard, use Grade A pricing</li> <li>other fabrics available, contact Customer Service</li> <li>com ydg: 1 3/4</li> <li>upper tackboard height: 2 1/4"</li> <li>lower tackboard height: 7 1/2"</li> <li>coordinates with WV1654DGSOC, WV1654GSOC, WV1654DSOC, WV1654SOC, WV1654SDC, WV1654SMOC and WV1654GSMOC</li> <li>accessory rail sold separately, see page 318</li> </ul>
							<b>Tackboard for Accessory Rail of 48" w Storage Overhead Cabinet with Cubbies</b> 
A \$278							
B \$311							
C \$371							
D \$449							
E \$525							
F \$645							
G \$773							
H \$911							
I \$1,124							
J \$1,380							
<ul style="list-style-type: none"> <li>tackboard panels for above and below accessory rail</li> <li>not required; add-on for convenience application</li> <li>Culp Montgomery Sterling panel fabric standard, use Grade A pricing</li> <li>other fabrics available, contact Customer Service</li> <li>com ydg: 1 3/4</li> <li>upper tackboard height: 2 1/4"</li> <li>lower tackboard height: 7 1/2"</li> <li>coordinates with WV1648DGSOC, WV1648GSOC, WV1648DSOC, WV1648SOC, WV1648SDC and WV1648SDC</li> <li>accessory rail sold separately, see page 318</li> </ul>							

VISION - VENEER

Description	D	W	H	CTN WT	CU FT	① Model	List Price Per Grade
<b>Tackboard for Accessory Rail of 42" w Storage Overhead Cabinet with Cubbies</b> 	3/8	40 1/8		6	4	VS42TKCA	COM \$242
							A \$258
							B \$286
							C \$338
							D \$404
							E \$470
							F \$573
							G \$682
							H \$800
							I \$983
							J \$1,203

<b>Tackboard for Accessory Rail of 36" w Storage Overhead Cabinet with Cubbies</b> 	3/8	34 1/8		5	3	VS36TKCA	COM \$221
							A \$234
							B \$258
							C \$301
							D \$356
							E \$411
							F \$496
							G \$588
							H \$686
							I \$838
							J \$1,022

<b>Tackboard for Accessory Rail of 30" w Storage Overhead Cabinet with Cubbies</b> 	3/8	28 1/8		5	2	VS30TKCA	COM \$201
							A \$214
							B \$238
							C \$281
							D \$336
							E \$391
							F \$476
							G \$569
							H \$666
							I \$818
							J \$1,002

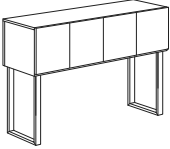
**To Order, Specify:**


- ① Model Number
- ② Fabric Selection: vendor, pattern, color

When ordering Quickship products, place a "Q" in front of model number.  
 Example: QVW3072DD

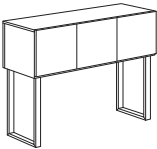





Description	D	W	H	CTN WT	CU FT	① Model	Flat Cut List Price	Double Cut List Price
<b>37" h Post Support Overhead Cabinet with Four Doors</b> 	16	72	37	194	16	<b>VV1672PSHD-37</b>	\$2,212	\$2,433
	16	66	37	181	15	<b>VV1666PSHD-37</b>	\$2,144	\$2,359
	16	60	37	170	13	<b>VV1660PSHD-37</b>	\$2,112	\$2,324
	16	54	37	167	12	<b>VV1654PSHD-37</b>	\$2,022	\$2,224

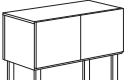



- locking doors available, specify and add \$210 list
- 21 <sup>13</sup>/<sub>16</sub>" vertical clearance
- no pulls
- post support legs to be field installed

<b>37" h Post Support Overhead Cabinet with Three Doors</b> 	16	48	37	157	11	<b>VV1648PSHDR-37</b>	\$1,642	\$1,806
	16	48	37	157	11	<b>VV1648PSHDL-37</b>	\$1,642	\$1,806
	16	42	37	146	10	<b>VV1642PSHDR-37</b>	\$1,476	\$1,624
	16	42	37	146	10	<b>VV1642PSHDL-37</b>	\$1,476	\$1,624



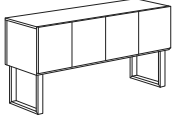
- locking doors available, specify and add \$210 list
- 21 <sup>13</sup>/<sub>16</sub>" vertical clearance
- right door configuration - 1 door hinges left and 2 doors hinge right
- left door configuration - 1 door hinges right and 2 doors hinge left
- no pulls
- post support legs to be field installed


<b>37" h Post Support Overhead Cabinet with Two Doors</b> 	16	36	37	137	9	<b>VV1636PSHD-37</b>	\$1,328	\$1,461
	16	30	37	132	8	<b>VV1630PSHD-37</b>	\$1,323	\$1,456



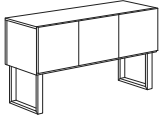
- locking doors available, specify and add \$105 list
- 21 <sup>13</sup>/<sub>16</sub>" vertical clearance
- no pulls
- post support legs to be field installed


VISION - VENEER

Description	D	W	H	CTN WT	CU FT	① Model	Flat Cut List Price	Double Cut List Price
<b>27" h Post Support Overhead Cabinet with Four Doors</b> 	16	72	27	194	16	<b>VW1672PSHD-27</b>	\$2,212	\$2,433
	16	66	27	181	15	<b>VW1666PSHD-27</b>	\$2,144	\$2,359
	16	60	27	170	13	<b>VW1660PSHD-27</b>	\$2,112	\$2,324
	16	54	27	167	12	<b>VW1654PSHD-27</b>	\$2,022	\$2,224

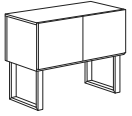



- locking doors available, specify and add \$210 list
- 12 1/8" vertical clearance
- no pulls
- post support legs to be field installed

<b>27" h Post Support Overhead Cabinet with Three Doors</b> 	16	48	27	157	11	<b>VW1648PSHDR-27</b>	\$1,642	\$1,806
	16	48	27	157	11	<b>VW1648PSHDL-27</b>	\$1,642	\$1,806
	16	42	27	146	10	<b>VW1642PSHDR-27</b>	\$1,476	\$1,624
	16	42	27	146	10	<b>VW1642PSHDL-27</b>	\$1,476	\$1,624



- locking doors available, specify and add \$210 list
- 12 1/8" vertical clearance
- right door configuration - 1 door hinges left and 2 doors hinge right
- left door configuration - 1 door hinges right and 2 doors hinge left
- no pulls
- post support legs to be field installed

<b>27" h Post Support Overhead Cabinet with Two Doors</b> 	16	36	27	137	9	<b>VW1636PSHD-27</b>	\$1,328	\$1,461
	16	30	27	132	8	<b>VW1630PSHD-27</b>	\$1,323	\$1,456



- locking doors available, specify and add \$105 list
- 12 1/8" vertical clearance
- no pulls
- post support legs to be field installed

**To Order, Specify:**

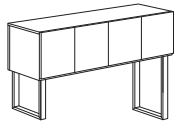
- ① Model Number
- ② Wood Species - Cherry (CH1), Maple (MA1), Walnut (WA1) or Double Cut (see page 228)
- ③ Finish Color (see page 229)
- ④ Metal Color - Black Sandtex (BSX) or Stardust Silver (STS) (see page 237)
- ⑤ Other Product Options (see page 229)

When ordering Quickship products, place a "Q" in front of model number.  
 Example: QV3072DD

**NOW!**  
*Need it.*  
 JSI Quickship

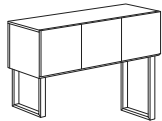
VISION - VENEER

Description	D	W	H	CTN WT	CU FT	① Model	Flat Cut List Price	Double Cut List Price
Split Height Post Support Overhead Cabinet with Four Doors	16	72	37	194	16	VV1672PSHD-2737	\$2,212	\$2,433
	16	66	37	181	15	VV1666PSHD-2737	\$2,144	\$2,359
	16	60	37	170	13	VV1660PSHD-2737	\$2,112	\$2,324
	16	54	37	167	12	VV1654PSHD-2737	\$2,022	\$2,224



- locking doors available, specify and add \$210 list
- 12 1/8" - 21 13/16" vertical clearance
- see page 245 for application of split height post support overhead
- no pulls
- post support legs to be field installed

Split Height Post Support Overhead Cabinet with Three Doors	16	48	37	157	11	VV1648PSHDR-2737	\$1,642	\$1,806
	16	48	37	157	11	VV1648PSHDL-2737	\$1,642	\$1,806
	16	42	37	146	10	VV1642PSHDR-2737	\$1,476	\$1,624
	16	42	37	146	10	VV1642PSHDL-2737	\$1,476	\$1,624



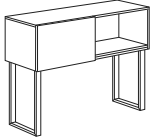
- locking doors available, specify and add \$210 list
- 12 1/8" - 21 13/16" vertical clearance
- see page 245 for application of split height post support overhead
- right door configuration - 1 door hinges left and 2 doors hinge right
- left door configuration - 1 door hinges right and 2 doors hinge left
- no pulls
- post support legs to be field installed

Split Height Post Support Overhead Cabinet with Two Doors	16	36	37	137	9	VV1636PSHD-2737	\$1,328	\$1,461
	16	30	37	132	8	VV1630PSHD-2737	\$1,323	\$1,456



- locking doors available, specify and add \$105 list
- 12 1/8" - 21 13/16" vertical clearance
- see page 245 for application of split height post support overhead
- no pulls
- post support legs to be field installed

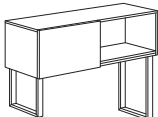
VISION - VENEER

Description	D	W	H	CTN WT	CU FT	① Model	Flat Cut List Price	Double Cut List Price
<b>37" h Post Support Overhead Cabinet with Sliding Door</b> 	16	72	37	194	16	<b>WV1672PSSD-37</b>	\$2,391	\$2,631
	16	66	37	181	15	<b>WV1666PSSD-37</b>	\$2,322	\$2,555
	16	60	37	170	13	<b>WV1660PSSD-37</b>	\$2,291	\$2,520
	16	54	37	167	12	<b>WV1654PSSD-37</b>	\$2,199	\$2,420
	16	48	37	157	11	<b>WV1648PSSD-37</b>	\$1,819	\$2,002
	16	42	37	146	10	<b>WV1642PSSD-37</b>	\$1,654	\$1,820
	16	36	37	137	9	<b>WV1636PSSD-37</b>	\$1,506	\$1,657
	16	30	37	132	8	<b>WV1630PSSD-37</b>	\$1,502	\$1,652

- 21 13/16" vertical clearance
- white markerboard doors available, specify and add \$163 list
- post support legs to be field installed
- locking doors not available

<b>27" h Post Support Overhead Cabinet with Sliding Door</b> 	16	72	27	194	16	<b>WV1672PSSD-27</b>	\$2,391	\$2,631
	16	66	27	181	15	<b>WV1666PSSD-27</b>	\$2,322	\$2,555
	16	60	27	170	13	<b>WV1660PSSD-27</b>	\$2,291	\$2,520
	16	54	27	167	12	<b>WV1654PSSD-27</b>	\$2,199	\$2,420
	16	48	27	157	11	<b>WV1648PSSD-27</b>	\$1,819	\$2,002
	16	42	27	146	10	<b>WV1642PSSD-27</b>	\$1,654	\$1,820
	16	36	27	137	9	<b>WV1636PSSD-27</b>	\$1,506	\$1,657
	16	30	27	132	8	<b>WV1630PSSD-27</b>	\$1,502	\$1,652

- 12 1/8" vertical clearance
- white markerboard doors available, specify and add \$163 list
- post support legs to be field installed
- locking doors not available

<b>Split Height Post Support Overhead Cabinet with Sliding Door</b> 	16	72	37	194	16	<b>WV1672PSSD-2737</b>	\$2,391	\$2,631
	16	66	37	181	15	<b>WV1666PSSD-2737</b>	\$2,322	\$2,555
	16	60	37	170	13	<b>WV1660PSSD-2737</b>	\$2,291	\$2,520
	16	54	37	167	12	<b>WV1654PSSD-2737</b>	\$2,199	\$2,420
	16	48	37	157	11	<b>WV1648PSSD-2737</b>	\$1,819	\$2,002
	16	42	37	146	10	<b>WV1642PSSD-2737</b>	\$1,654	\$1,820
	16	36	37	137	9	<b>WV1636PSSD-2737</b>	\$1,506	\$1,657
	16	30	37	132	8	<b>WV1630PSSD-2737</b>	\$1,502	\$1,652

- 12 1/8" - 21 13/16" vertical clearance
- see page 245 for application of split height post support overhead
- white markerboard doors available, specify and add \$163 list
- post support legs to be field installed
- locking doors not available


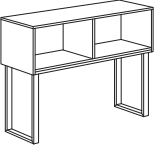
**To Order, Specify:**

- ① Model Number
- ② Wood Species - Cherry (CH1), Maple (MA1), Walnut (WA1) or Double Cut (see page 228)
- ③ Finish Color (see page 229)
- ④ Metal Color - Black Sandtex (BSX) or Stardust Silver (STS) (see page 237)
- ⑤ Other Product Options (see page 229)


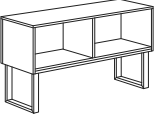
When ordering Quickship products, place a "Q" in front of model number.  
 Example: QVV3072DD

**NOW!**  
*Need it.*  
 JSI Quickship

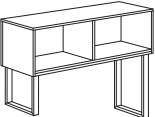
VISION - VENEER

Description	D	W	H	CTN WT	CU FT	① Model	Flat Cut List Price	Double Cut List Price
<b>37" h Post Support Open Overhead Cabinet</b>  	16	72	37	184	16	<b>VV1672PSO-37</b>	\$2,114	\$2,326
	16	66	37	172	15	<b>VV1666PSO-37</b>	\$2,046	\$2,251
	16	60	37	163	13	<b>VV1660PSO-37</b>	\$2,014	\$2,216
	16	54	37	160	12	<b>VV1654PSO-37</b>	\$1,923	\$2,116
	16	48	37	151	11	<b>VV1648PSO-37</b>	\$1,568	\$1,726
	16	42	37	140	10	<b>VV1642PSO-37</b>	\$1,402	\$1,543
	16	36	37	132	9	<b>VV1636PSO-37</b>	\$1,254	\$1,380
	16	30	37	127	8	<b>VV1630PSO-37</b>	\$1,250	\$1,375

- 21 13/16" vertical clearance
- post support legs to be field installed

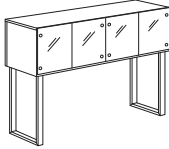
Description	D	W	H	CTN WT	CU FT	① Model	Flat Cut List Price	Double Cut List Price
<b>27" h Post Support Open Overhead Cabinet</b>  	16	72	27	184	16	<b>VV1672PSO-27</b>	\$2,114	\$2,326
	16	66	27	172	15	<b>VV1666PSO-27</b>	\$2,046	\$2,251
	16	60	27	163	13	<b>VV1660PSO-27</b>	\$2,014	\$2,216
	16	54	27	160	12	<b>VV1654PSO-27</b>	\$1,923	\$2,116
	16	48	27	151	11	<b>VV1648PSO-27</b>	\$1,568	\$1,726
	16	42	27	140	10	<b>VV1642PSO-27</b>	\$1,402	\$1,543
	16	36	27	132	9	<b>VV1636PSO-27</b>	\$1,254	\$1,380
	16	30	27	127	8	<b>VV1630PSO-27</b>	\$1,250	\$1,375

- 12 1/8" vertical clearance
- post support legs to be field installed

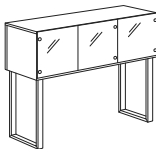
Description	D	W	H	CTN WT	CU FT	① Model	Flat Cut List Price	Double Cut List Price
<b>Split Height Post Support Open Overhead Cabinet</b>  	16	72	27	184	16	<b>VV1672PSO-2737</b>	\$2,114	\$2,326
	16	66	27	172	15	<b>VV1666PSO-2737</b>	\$2,046	\$2,251
	16	60	27	163	13	<b>VV1660PSO-2737</b>	\$2,014	\$2,216
	16	54	27	160	12	<b>VV1654PSO-2737</b>	\$1,923	\$2,116
	16	48	27	151	11	<b>VV1648PSO-2737</b>	\$1,568	\$1,726
	16	42	27	140	10	<b>VV1642PSO-2737</b>	\$1,402	\$1,543
	16	36	27	132	9	<b>VV1636PSO-2737</b>	\$1,254	\$1,380
	16	30	27	127	8	<b>VV1630PSO-2737</b>	\$1,250	\$1,375

- 12 1/8" - 21 13/16" vertical clearance
- see page 245 for application of split height post support overhead
- post support legs to be field installed


VISION - VENEER

Description	D	W	H	CTN WT	CU FT	① Model	Flat Cut List		Double Cut List	
							Frameless	Aluminum Frame	Frameless	Aluminum Frame
<b>37" h Post Support Overhead Cabinet with Four Glass Doors</b> 	16	72	37	192	16	<b>WV1672PSGHD-37</b>	\$2,348	\$2,908	\$2,583	\$3,199
	16	66	37	179	15	<b>WV1666PSGHD-37</b>	\$2,281	\$2,826	\$2,510	\$3,110
	16	60	37	168	13	<b>WV1660PSGHD-37</b>	\$2,249	\$2,777	\$2,474	\$3,055
	16	54	37	165	12	<b>WV1654PSGHD-37</b>	\$2,159	\$2,672	\$2,376	\$2,939

- select Frosted Frameless, Frosted with Aluminum Frame or White Back Painted with Aluminum Frame
- 21 13/16" vertical clearance
- post support legs to be field installed
- locking doors not available
- pulls not available

<b>37" h Post Support Overhead Cabinet with Three Glass Doors</b> 	16	48	37	155	11	<b>WV1648PSGHDR-37</b>	\$1,779	\$2,184	\$1,958	\$2,403
	16	48	37	155	11	<b>WV1648PSGHDL-37</b>	\$1,779	\$2,184	\$1,958	\$2,403
	16	42	37	144	10	<b>WV1642PSGHDR-37</b>	\$1,612	\$2,002	\$1,774	\$2,202
	16	42	37	144	10	<b>WV1642PSGHDL-37</b>	\$1,612	\$2,002	\$1,774	\$2,202

- select Frosted Frameless, Frosted with Aluminum Frame or White Back Painted with Aluminum Frame
- 21 13/16" vertical clearance
- right door configuration - 1 door hinges left and 2 doors hinge right
- left door configuration - 1 door hinges right and 2 doors hinge left
- post support legs to be field installed
- locking doors not available
- pulls not available

<b>37" h Post Support Overhead Cabinet with Two Glass Doors</b> 	16	36	37	135	9	<b>WV1636PSGHD-37</b>	\$1,464	\$1,745	\$1,611	\$1,920
	16	30	37	130	8	<b>WV1630PSGHD-37</b>	\$1,460	\$1,725	\$1,606	\$1,898

- select Frosted Frameless, Frosted with Aluminum Frame or White Back Painted with Aluminum Frame
- 21 13/16" vertical clearance
- post support legs to be field installed
- locking doors not available
- pulls not available

**To Order, Specify:**

- ① Model Number
- ② Wood Species - Cherry (CH1), Maple (MA1), Walnut (WA1) or Double Cut (see page 228)
- ③ Finish Color (see page 229)
- ④ Glass Option/Color (see page 237)
- ⑤ Metal Color - Black Sandtex (BSX) or Stardust Silver (STS) (see page 237)
- ⑥ Other Product Options (see page 229)

When ordering Quickship products, place a "Q" in front of model number.  
Example: QV3072DD

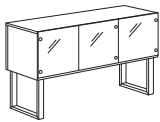


Description	D	W	H	CTN WT	CU FT	① Model	Flat Cut List		Double Cut List	
							Frameless	Aluminum Frame	Frameless	Aluminum Frame
27" h Post Support Overhead Cabinet with Four Glass Doors	16	72	27	192	16	<b>VW1672PSGHD-27</b>	\$2,348	\$2,908	\$2,583	\$3,199
	16	66	27	179	15	<b>VW1666PSGHD-27</b>	\$2,281	\$2,826	\$2,510	\$3,110
	16	60	27	168	13	<b>VW1660PSGHD-27</b>	\$2,249	\$2,777	\$2,474	\$3,055
	16	54	27	165	12	<b>VW1654PSGHD-27</b>	\$2,159	\$2,672	\$2,376	\$2,939



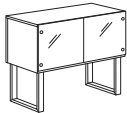
- select Frosted Frameless, Frosted with Aluminum Frame or White Back Painted with Aluminum Frame
- 12 1/8" vertical clearance
- post support legs to be field installed
- locking doors not available
- pulls not available

27" h Post Support Overhead Cabinet with Three Glass Doors	16	48	27	155	11	<b>VW1648PSGHDR-27</b>	\$1,779	\$2,184	\$1,958	\$2,403
	16	48	27	155	11	<b>VW1648PSGHDL-27</b>	\$1,779	\$2,184	\$1,958	\$2,403
	16	42	27	144	10	<b>VW1642PSGHDR-27</b>	\$1,612	\$2,002	\$1,774	\$2,202
	16	42	27	144	10	<b>VW1642PSGHDL-27</b>	\$1,612	\$2,002	\$1,774	\$2,202



- select Frosted Frameless, Frosted with Aluminum Frame or White Back Painted with Aluminum Frame
- 12 1/8" vertical clearance
- right door configuration - 1 door hinges left and 2 doors hinge right
- left door configuration - 1 door hinges right and 2 doors hinge left
- post support legs to be field installed
- locking doors not available
- pulls not available

27" h Post Support Overhead Cabinet with Two Glass Doors	16	36	27	135	9	<b>VW1636PSGHD-27</b>	\$1,464	\$1,745	\$1,611	\$1,920
	16	30	27	130	8	<b>VW1630PSGHD-27</b>	\$1,460	\$1,725	\$1,606	\$1,898



- select Frosted Frameless, Frosted with Aluminum Frame or White Back Painted with Aluminum Frame
- 12 1/8" vertical clearance
- post support legs to be field installed
- locking doors not available
- pulls not available

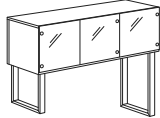
VISION - VENEER

Description	D	W	H	CTN WT	CU FT	① Model	Flat Cut List		Double Cut List	
							Frameless	Aluminum Frame	Frameless	Aluminum Frame
Split Height Post Support Overhead Cabinet with Four Glass Doors	16	72	37	192	16	<b>W1672PSGHD-2737</b>	\$2,348	\$2,908	\$2,583	\$3,199
	16	66	37	179	15	<b>W1666PSGHD-2737</b>	\$2,281	\$2,826	\$2,510	\$3,110
	16	60	37	168	13	<b>W1660PSGHD-2737</b>	\$2,249	\$2,777	\$2,474	\$3,055
	16	54	37	165	12	<b>W1654PSGHD-2737</b>	\$2,159	\$2,672	\$2,376	\$2,939



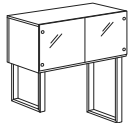
- select Frosted Frameless, Frosted with Aluminum Frame or White Back Painted with Aluminum Frame
- 12 1/8" - 21 13/16" vertical clearance
- see page 245 for application of split height post support overhead
- post support legs to be field installed
- locking doors not available
- pulls not available

Split Height Post Support Overhead Cabinet with Three Glass Doors	16	48	37	155	11	<b>W1648PSGHDR-2737</b>	\$1,779	\$2,184	\$1,958	\$2,403
	16	48	37	155	11	<b>W1648PSGHDL-2737</b>	\$1,779	\$2,184	\$1,958	\$2,403
	16	42	37	144	10	<b>W1642PSGHDR-2737</b>	\$1,612	\$2,002	\$1,774	\$2,202
	16	42	37	144	10	<b>W1642PSGHDL-2737</b>	\$1,612	\$2,002	\$1,774	\$2,202



- select Frosted Frameless, Frosted with Aluminum Frame or White Back Painted with Aluminum Frame
- 12 1/8" - 21 13/16" vertical clearance
- see page 245 for application of split height post support overhead
- right door configuration - 1 door hinges left and 2 doors hinge right
- left door configuration - 1 door hinges right and 2 doors hinge left
- post support legs to be field installed
- locking doors not available
- pulls not available

Split Height Post Support Overhead Cabinet with Two Glass Doors	16	36	37	135	9	<b>W1636PSGHD-2737</b>	\$1,464	\$1,745	\$1,611	\$1,920
	16	30	37	130	8	<b>W1630PSGHD-2737</b>	\$1,460	\$1,725	\$1,606	\$1,898



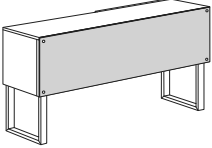
- select Frosted Frameless, Frosted with Aluminum Frame or White Back Painted with Aluminum Frame
- 12 1/8" - 21 13/16" vertical clearance
- see page 245 for application of split height post support overhead
- post support legs to be field installed
- locking doors not available
- pulls not available

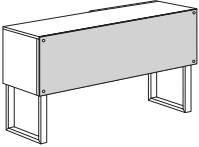
**To Order, Specify:**

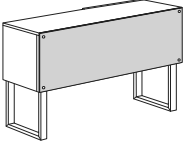
- ① Model Number
- ② Wood Species - Cherry (CH1), Maple (MA1), Walnut (WA1) or Double Cut (see page 228)
- ③ Finish Color (see page 229)
- ④ Glass Option/Color (see page 237)
- ⑤ Metal Color - Black Sandtex (BSX) or Stardust Silver (STS) (see page 237)
- ⑥ Other Product Options (see page 229)

VISION - VENEER

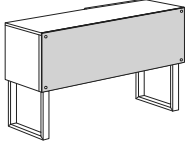


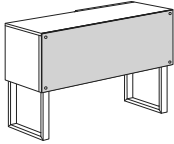
Description	D	W	H	CTN WT	CU FT	① Model	List Price Per Grade
<b>Tackboard for Back of 72" w Post Support Overhead Cabinet</b>  <p><b>NOW!</b></p> <ul style="list-style-type: none"> <li>· for use with 72" wide storage overhead cabinet</li> <li>· Culp Montgomery Sterling panel fabric standard, use Grade A pricing</li> <li>· other fabrics available, contact Customer Service</li> <li>· attaches with covered button screws</li> <li>· ships attached when ordered with overhead cabinets</li> <li>· com ydg: 2 1/4</li> </ul>	3/8	72	15	8	6	<b>VS1572TK</b>	<b>COM</b> \$272
	A	\$296					
	B	\$339					
	C	\$416					
	D	\$515					
	E	\$614					
	F	\$768					
	G	\$933					
	H	\$1,108					
	I	\$1,383					
	J	\$1,713					

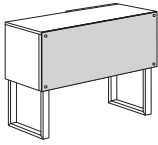
<b>Tackboard for Back of 66" w Post Support Overhead Cabinet</b>  <p><b>NOW!</b></p> <ul style="list-style-type: none"> <li>· for use with 66" wide storage overhead cabinet</li> <li>· Culp Montgomery Sterling panel fabric standard, use Grade A pricing</li> <li>· other fabrics available, contact Customer Service</li> <li>· attaches with covered button screws</li> <li>· ships attached when ordered with overhead cabinets</li> <li>· com ydg: 2</li> </ul>	3/8	66	15	8	6	<b>VS1566TK</b>	<b>COM</b> \$255
	A	\$275					
	B	\$313					
	C	\$383					
	D	\$470					
	E	\$558					
	F	\$695					
	G	\$842					
	H	\$998					
	I	\$1,243					
	J	\$1,536					

<b>Tackboard for Back of 60" w Post Support Overhead Cabinet</b>  <p><b>NOW!</b></p> <ul style="list-style-type: none"> <li>· for use with 60" wide storage overhead cabinet</li> <li>· Culp Montgomery Sterling panel fabric standard, use Grade A pricing</li> <li>· other fabrics available, contact Customer Service</li> <li>· attaches with covered button screws</li> <li>· ships attached when ordered with overhead cabinets</li> <li>· com ydg: 2</li> </ul>	3/8	60	15	7	5	<b>VS1560TK</b>	<b>COM</b> \$249
	A	\$269					
	B	\$308					
	C	\$377					
	D	\$465					
	E	\$553					
	F	\$689					
	G	\$836					
	H	\$993					
	I	\$1,237					
	J	\$1,530					

VISION - VENEER

Description	D	W	H	CTN WT	CU FT	① Model	List Price Per Grade
<b>Tackboard for Back of 54" w Post Support Overhead Cabinet</b>	3/8	54	15	7	5	<b>VS1554TK</b>	<b>COM \$231</b>
 <p><b>NOW!</b></p> <ul style="list-style-type: none"> <li>for use with 54" wide storage overhead cabinet</li> <li>Culp Montgomery Sterling panel fabric standard, use Grade A pricing</li> <li>other fabrics available, contact Customer Service</li> <li>attaches with covered button screws</li> <li>ships attached when ordered with overhead cabinets</li> <li>com ydg: 1 3/4</li> </ul>	A						\$249
	B						\$283
	C						\$343
	D						\$420
	E						\$497
	F						\$617
	G						\$745
	H						\$882
	I						\$1,096
	J						\$1,352

<b>Tackboard for Back of 48" w Post Support Overhead Cabinet</b>	3/8	48	15	7	4	<b>VS1548TK</b>	<b>COM \$227</b>
 <p><b>NOW!</b></p> <ul style="list-style-type: none"> <li>for use with 72" wide storage overhead cabinet</li> <li>Culp Montgomery Sterling panel fabric standard, use Grade A pricing</li> <li>other fabrics available, contact Customer Service</li> <li>attaches with covered button screws</li> <li>ships attached when ordered with overhead cabinets</li> <li>com ydg: 1 3/4</li> </ul>	A						\$245
	B						\$279
	C						\$339
	D						\$416
	E						\$493
	F						\$613
	G						\$741
	H						\$878
	I						\$1,091
	J						\$1,348

<b>Tackboard for Back of 42" w Post Support Overhead Cabinet</b>	3/8	42	15	6	4	<b>VS1542TK</b>	<b>COM \$209</b>
 <p><b>NOW!</b></p> <ul style="list-style-type: none"> <li>for use with 42" wide storage overhead cabinet</li> <li>Culp Montgomery Sterling panel fabric standard, use Grade A pricing</li> <li>other fabrics available, contact Customer Service</li> <li>attaches with covered button screws</li> <li>ships attached when ordered with overhead cabinets</li> <li>com ydg: 1 1/2</li> </ul>	A						\$225
	B						\$254
	C						\$305
	D						\$371
	E						\$437
	F						\$540
	G						\$649
	H						\$767
	I						\$951
	J						\$1,170

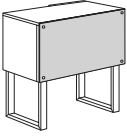
**To Order, Specify:**

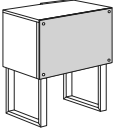
- ① Model Number
- ② Fabric Selection: vendor, pattern, color

When ordering Quickship products, place a "Q" in front of model number.  
Example: QV3072DD

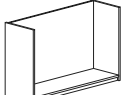
**NOW!**  
*Need it.*  
JSI Quickship

VISION - VENEER

Description	D	W	H	CTN WT	CU FT	① Model	List Price Per Grade
<b>Tackboard for Back of 36" w Post Support Overhead Cabinet</b>  <ul style="list-style-type: none"> <li>· for use with 36" wide storage overhead cabinet</li> <li>· Culp Montgomery Sterling panel fabric standard, use Grade A pricing</li> <li>· other fabrics available, contact Customer Service</li> <li>· attaches with covered button screws</li> <li>· ships attached when ordered with overhead cabinets</li> <li>· com ydg: 1 1/4</li> </ul>	3/8	36	15	5	3	<b>VS1536TK</b>	<b>COM</b> \$188
	A	\$201					
	B	\$225					
	C	\$268					
	D	\$324					
	E	\$378					
	F	\$464					
	G	\$556					
	H	\$654					
	I	\$806					
	J	\$990					

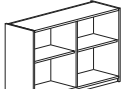
<b>Tackboard for Back of 30" w Post Support Overhead Cabinet</b>  <ul style="list-style-type: none"> <li>· for use with 30" wide storage overhead cabinet</li> <li>· Culp Montgomery Sterling panel fabric standard, use Grade A pricing</li> <li>· other fabrics available, contact Customer Service</li> <li>· attaches with covered button screws</li> <li>· ships attached when ordered with overhead cabinets</li> <li>· com ydg: 1 1/4</li> </ul>	3/8	30	15	5	2	<b>VS1530TK</b>	<b>COM</b> \$168
	A	\$181					
	B	\$205					
	C	\$248					
	D	\$304					
	E	\$359					
	F	\$444					
	G	\$536					
	H	\$634					
	I	\$786					
	J	\$970					

VISION - VENEER

Description	D	W	H	CTN WT	CU FT	① Model	Flat Cut List Price	Double Cut List Price
<b>Double Height Wall Mount Overhead Shelf</b> 	15 7/16	54	30	85	19	VV1554WDTS	\$727	\$801
	15 7/16	48	30	76	17	VV1548WDTS	\$636	\$700
	15 7/16	42	30	67	15	VV1542WDTS	\$577	\$636
	15 7/16	36	30	58	13	VV1536WDTS	\$495	\$544
	15 7/16	30	30	55	11	VV1530WDTS	\$491	\$540

**NOW!**

· supported by wall cleat - hardware provided by installer

<b>Double Height Wall Mount Open Overhead</b> 	15 7/16	54	30	95	19	VV1554DWOO	\$1,393	\$1,532
	15 7/16	48	30	89	17	VV1548DWOO	\$1,270	\$1,397
	15 7/16	42	30	80	15	VV1542DWOO	\$1,155	\$1,271
	15 7/16	36	30	69	13	VV1536DWOO	\$1,053	\$1,159
	15 7/16	30	30	60	11	VV1530DWOO	\$954	\$1,049

**NOW!**


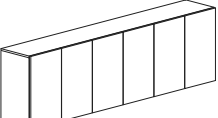
· supported by wall cleat - hardware provided by installer

**To Order, Specify:**


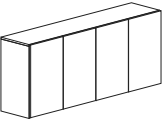
- ① Model Number
- ② Wood Species - Cherry (CH1), Maple (MA1), Walnut (WA1) or Double Cut (see page 228)
- ③ Finish Color (see page 229)
- ④ Fabric Selection: vendor, pattern, color
- ⑤ Other Product Options (see page 229)

When ordering Quickship products, place a "Q" in front of model number.  
 Example: QVV3072DD


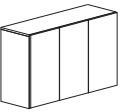
**NOW!**  
*Need it.*  
 JSI Quickship

Description	D	W	H	CTN WT	CU FT	① Model	Flat Cut List Price	Double Cut List Price
<b>Double Height Wall Mount Overhead Cabinet with Six Doors</b>  	16	108	30	366	37	VV16108WDSO	\$3,796	\$4,176
	16	102	30	346	35	VV16102WDSO	\$3,586	\$3,945
	16	96	30	325	33	VV1696WDSO	\$3,374	\$3,712
	16	90	30	306	31	VV1690WDSO	\$3,164	\$3,481


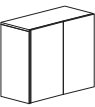
- supported by wall cleat - hardware provided by installer
- locking doors available, specify and add \$315 list
- no pulls

<b>Double Height Wall Mount Overhead Cabinet with Four Doors</b>  	16	84	30	285	29	VV1684WDSO	\$2,952	\$3,248
	16	78	30	264	27	VV1678WDSO	\$2,742	\$3,017
	16	72	30	244	25	VV1672WDSO	\$2,531	\$2,784
	16	66	30	227	23	VV1666WDSO	\$2,421	\$2,663
	16	60	30	212	21	VV1660WDSO	\$2,302	\$2,533
	16	54	30	208	19	VV1654WDSO	\$2,076	\$2,284

- supported by wall cleat - hardware provided by installer
- locking doors available, specify and add \$210 list
- no pulls

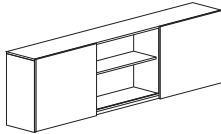
<b>Double Height Wall Mount Overhead Cabinet with Three Doors</b>  	16	48	30	201	17	VV1648WDSOR	\$1,817	\$1,999
	16	48	30	201	17	VV1648WDSOL	\$1,817	\$1,999
	16	42	30	185	15	VV1642WDSOR	\$1,668	\$1,835
	16	42	30	185	15	VV1642WDSOL	\$1,668	\$1,835

- supported by wall cleat - hardware provided by installer
- locking doors available, specify and add \$210 list
- right door configuration - 1 door hinges left and 2 doors hinge right
- left door configuration - 1 door hinges right and 2 doors hinge left
- no pulls

<b>Double Height Wall Mount Overhead Cabinet with Two Doors</b>  	16	36	30	173	13	VV1636WDSO	\$1,564	\$1,720
	16	30	30	167	11	VV1630WDSO	\$1,489	\$1,638

- supported by wall cleat - hardware provided by installer
- locking doors available, specify and add \$105 list
- no pulls

VISION - VENEER

Description	D	W	H	CTN WT	CU FT	① Model	Flat Cut List Price	Double Cut List Price
<b>Double Height Wall Mount Overhead Cabinet with Two Sliding Doors</b> 	16	108	30	366	37	VV16108WSDSD	\$4,175	\$4,593
	16	102	30	346	35	VV16102WSDSD	\$3,945	\$4,340
	16	96	30	325	33	VV1696WSDSD	\$3,711	\$4,083
	16	90	30	306	31	VV1690WSDSD	\$3,481	\$3,830

**NOW!**

- supported by wall cleat - hardware provided by installer
- white markerboard doors available, specify and add \$431 list
- locking doors not available

<b>Double Height Wall Mount Overhead Cabinet with Sliding Door</b> 	16	84	30	285	29	VV1684WSDSD	\$3,248	\$3,574
	16	78	30	264	27	VV1678WSDSD	\$3,016	\$3,318
	16	72	30	244	25	VV1672WSDSD	\$2,834	\$3,118
	16	66	30	227	23	VV1666WSDSD	\$2,743	\$3,018
	16	60	30	212	21	VV1660WSDSD	\$2,637	\$2,902
	16	54	30	208	19	VV1654WSDSD	\$2,534	\$2,788
	16	48	30	201	17	VV1648WSDSD	\$2,270	\$2,497
	16	42	30	185	15	VV1642WSDSD	\$2,175	\$2,393
	16	36	30	173	13	VV1636WSDSD	\$2,012	\$2,214
	16	30	30	167	11	VV1630WSDSD	\$1,988	\$2,188

**NOW!**

- supported by wall cleat - hardware provided by installer
- white markerboard doors available, specify and add \$216 list
- locking doors not available

VISION - VENEER

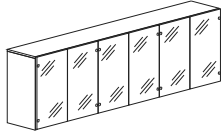
**To Order, Specify:**

- ① Model Number
- ② Wood Species - Cherry (CH1), Maple (MA1), Walnut (WA1) or Double Cut (see page 228)
- ③ Finish Color (see page 229)
- ④ Other Product Options (see page 229)

When ordering Quickship products, place a "Q" in front of model number.  
Example: QVV3072DD

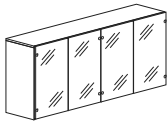


Description	D	W	H	CTN WT	CU FT	① Model	Flat Cut List		Double Cut List	
							Frameless	Aluminum Frame	Frameless	Aluminum Frame
<b>Double Height Wall Mount Overhead Cabinet with Six Glass Doors</b>	16	108	30	366	37	<b>VV16108WDGSO</b>	\$4,130	\$5,194	\$4,544	\$5,714
	16	102	30	346	35	<b>VV16102WDGSO</b>	\$3,920	\$4,968	\$4,313	\$5,466
	16	96	30	325	33	<b>VV1696WDGSO</b>	\$3,708	\$4,737	\$4,080	\$5,212
	16	90	30	306	31	<b>VV1690WDGSO</b>	\$3,499	\$4,510	\$3,850	\$4,962



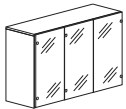
- select Frosted Frameless, Frosted with Aluminum Frame or White Back Painted with Aluminum Frame
- supported by wall cleat - hardware provided by installer
- locking doors not available
- pulls not available

<b>Double Height Wall Mount Overhead Cabinet with Four Glass Doors</b>	16	84	30	285	29	<b>VV1684WDGSO</b>	\$3,343	\$4,088	\$3,678	\$4,498
	16	78	30	264	27	<b>VV1678WDGSO</b>	\$3,117	\$3,845	\$3,429	\$4,230
	16	72	30	244	25	<b>VV1672WDGSO</b>	\$2,939	\$3,648	\$3,233	\$4,014
	16	66	30	227	23	<b>VV1666WDGSO</b>	\$2,811	\$3,504	\$3,093	\$3,855
	16	60	30	212	21	<b>VV1660WDGSO</b>	\$2,645	\$3,320	\$2,910	\$3,652
	16	54	30	208	19	<b>VV1654WDGSO</b>	\$2,495	\$3,153	\$2,745	\$3,469



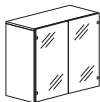
- select Frosted Frameless, Frosted with Aluminum Frame or White Back Painted with Aluminum Frame
- supported by wall cleat - hardware provided by installer
- locking doors not available
- pulls not available

<b>Double Height Wall Mount Overhead Cabinet with Three Glass Doors</b>	16	48	30	201	17	<b>VV1648WDGSOR</b>	\$2,224	\$2,740	\$2,447	\$3,014
	16	48	30	201	17	<b>VV1648WDGSOL</b>	\$2,224	\$2,740	\$2,447	\$3,014
	16	42	30	185	15	<b>VV1642WDGSOR</b>	\$2,042	\$2,538	\$2,246	\$2,792
	16	42	30	185	15	<b>VV1642WDGSOL</b>	\$2,042	\$2,538	\$2,246	\$2,792

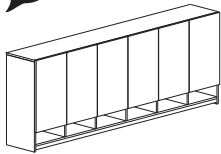


- select Frosted Frameless, Frosted with Aluminum Frame or White Back Painted with Aluminum Frame
- supported by wall cleat - hardware provided by installer
- right door configuration - 1 door hinges left and 2 doors hinge right
- left door configuration - 1 door hinges right and 2 doors hinge left
- locking doors not available
- pulls not available

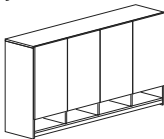
<b>Double Height Wall Mount Overhead Cabinet with Two Glass Doors</b>	16	36	30	173	13	<b>VV1636WDGSO</b>	\$1,817	\$2,172	\$1,999	\$2,389
	16	30	30	167	11	<b>VV1630WDGSO</b>	\$1,713	\$2,050	\$1,885	\$2,256



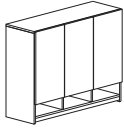
- select Frosted Frameless, Frosted with Aluminum Frame or White Back Painted with Aluminum Frame
- supported by wall cleat - hardware provided by installer
- locking doors not available
- pulls not available

Description	D	W	H	CTN WT	CU FT	① Model	Flat Cut List Price	Double Cut List Price
<b>Double Height Wall Mount Overhead Cabinet with Six Doors and Cubbies</b> 	16	108	36	411	44	VV16108WDSOC	\$4,574	\$5,032
	16	102	36	389	42	VV16102WDSOC	\$4,321	\$4,754
	16	96	36	365	39	VV1696WDSOC	\$4,066	\$4,473
	16	90	36	344	37	VV1690WDSOC	\$3,813	\$4,195

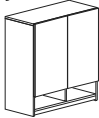
- supported by wall cleat - hardware provided by installer
- locking doors available, specify and add \$315 list
- no pulls

<b>Double Height Wall Mount Overhead Cabinet with Four Doors and Cubbies</b> 	16	84	36	320	35	VV1684WDSOC	\$3,558	\$3,914
	16	78	36	297	32	VV1678WDSOC	\$3,304	\$3,635
	16	72	36	274	30	VV1672WDSOC	\$3,072	\$3,379
	16	66	36	255	27	VV1666WDSOC	\$2,913	\$3,205
	16	60	36	237	25	VV1660WDSOC	\$2,827	\$3,111
	16	54	36	231	23	VV1654WDSOC	\$2,704	\$2,975

- supported by wall cleat - hardware provided by installer
- locking doors available, specify and add \$210 list
- no pulls

<b>Double Height Wall Mount Overhead Cabinet with Three Doors and Cubbies</b> 	16	48	36	221	20	VV1648WDSOCR	\$2,324	\$2,557
	16	48	36	221	20	VV1648WDSOCL	\$2,324	\$2,557
	16	42	36	203	18	VV1642WDSOCR	\$2,054	\$2,260
	16	42	36	203	18	VV1642WDSOCL	\$2,054	\$2,260

- supported by wall cleat - hardware provided by installer
- locking doors available, specify and add \$210 list
- right door configuration - 1 door hinges left and 2 doors hinge right
- left door configuration - 1 door hinges right and 2 doors hinge left
- no pulls

<b>Double Height Wall Mount Overhead Cabinet with Two Doors and Cubbies</b> 	16	36	36	188	16	VV1636WDSOC	\$1,923	\$2,116
	16	30	36	180	13	VV1630WDSOC	\$1,774	\$1,951

- supported by wall cleat - hardware provided by installer
- locking doors available, specify and add \$105 list
- no pulls

**To Order, Specify:**

- ① Model Number
- ② Wood Species - Cherry (CH1), Maple (MA1), Walnut (WA1) or Double Cut (see page 228)
- ③ Finish Color (see page 229)
- ④ Glass Option/Color (see page 237)
- ⑤ Other Product Options (see page 229)

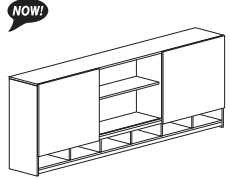
When ordering Quickship products, place a "Q" in front of model number.  
 Example: QVV3072DD

**NOW!**  
 Need it.  
 JSI Quickship

VISION - VENEER

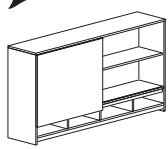


Description	D	W	H	CTN WT	CU FT	① Model	Flat Cut List Price	Double Cut List Price
Double Height Wall Mount Overhead Cabinet with Two Sliding Doors and Cubbies	16	108	36	411	44	VV16108WSDSDC	\$4,804	\$5,285
	16	102	36	389	42	VV16102WSDSDC	\$4,512	\$4,964
	16	96	36	365	39	VV1696WSDSDC	\$4,404	\$4,845
	16	90	36	344	37	VV1690WSDSDC	\$4,130	\$4,544



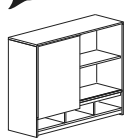
- supported by wall cleat - hardware provided by installer
- white markerboard doors available, specify and add \$431 list
- locking doors not available
- pulls not available

Double Height Wall Mount Overhead Cabinet with Sliding Door and Cubbies	16	84	36	320	35	VV1684WSDSDC	\$3,853	\$4,238
	16	78	36	297	32	VV1678WSDSDC	\$3,579	\$3,937
	16	72	36	274	30	VV1672WSDSDC	\$3,375	\$3,713
	16	66	36	255	27	VV1666WSDSDC	\$3,219	\$3,541
	16	60	36	237	25	VV1660WSDSDC	\$3,131	\$3,444
	16	54	36	231	23	VV1654WSDSDC	\$2,879	\$3,167



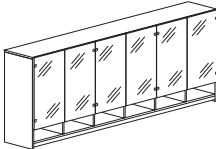
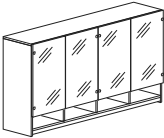
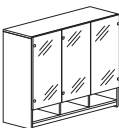

- supported by wall cleat - hardware provided by installer
- white markerboard doors available, specify and add \$216 list
- locking doors not available
- pulls not available

Double Height Wall Mount Overhead Cabinet with Sliding Door and Cubbies	16	48	36	221	20	VV1648WSDSDC	\$2,551	\$2,806
	16	42	36	203	18	VV1642WSDSDC	\$2,453	\$2,699
	16	36	36	188	16	VV1636WSDSDC	\$2,361	\$2,597
	16	30	36	180	13	VV1630WSDSDC	\$2,344	\$2,579



- supported by wall cleat - hardware provided by installer
- white markerboard doors available, specify and add \$216 list
- locking doors not available
- pulls not available

VISION - VENEER

Description	D	W	H	CTN WT	CU FT	① Model	Flat Cut List		Double Cut List	
							Frameless	Aluminum Frame	Frameless	Aluminum Frame
<b>Double Height Wall Mount Overhead Cabinet with Six Glass Doors and Cubbies</b> 	16	108	36	411	44	<b>VW16108WDGSOC</b>	\$4,909	\$5,973	\$5,401	\$6,570
	16	102	36	389	42	<b>VW16102WDGSOC</b>	\$4,656	\$5,704	\$5,122	\$6,275
	16	96	36	365	39	<b>VW1696WDGSOC</b>	\$4,401	\$5,430	\$4,842	\$5,974
	16	90	36	344	37	<b>VW1690WDGSOC</b>	\$4,148	\$5,159	\$4,563	\$5,676
<ul style="list-style-type: none"> <li>• select Frosted Frameless, Frosted with Aluminum Frame or White Back Painted with Aluminum Frame</li> <li>• supported by wall cleat - hardware provided by installer</li> <li>• locking doors not available</li> <li>• pulls not available</li> </ul>										
<b>Double Height Wall Mount Overhead Cabinet with Four Glass Doors and Cubbies</b> 	16	84	36	320	35	<b>VW1684WDGSOC</b>	\$3,779	\$4,525	\$4,157	\$4,977
	16	78	36	297	32	<b>VW1678WDGSOC</b>	\$3,525	\$4,253	\$3,878	\$4,678
	16	72	36	274	30	<b>VW1672WDGSOC</b>	\$3,477	\$4,186	\$3,826	\$4,605
	16	66	36	255	27	<b>VW1666WDGSOC</b>	\$3,383	\$4,076	\$3,722	\$4,484
	16	60	36	237	25	<b>VW1660WDGSOC</b>	\$3,171	\$3,846	\$3,489	\$4,231
	16	54	36	231	23	<b>VW1654WDGSOC</b>	\$2,927	\$3,584	\$3,220	\$3,943
<ul style="list-style-type: none"> <li>• select Frosted Frameless, Frosted with Aluminum Frame or White Back Painted with Aluminum Frame</li> <li>• supported by wall cleat - hardware provided by installer</li> <li>• locking doors not available</li> <li>• pulls not available</li> </ul>										
<b>Double Height Wall Mount Overhead Cabinet with Three Glass Doors and Cubbies</b> 	16	48	36	221	20	<b>VW1648WDGSOCR</b>	\$2,652	\$3,167	\$2,917	\$3,484
	16	48	36	221	20	<b>VW1648WDGSOCL</b>	\$2,652	\$3,167	\$2,917	\$3,484
	16	42	36	203	18	<b>VW1642WDGSOCR</b>	\$2,504	\$3,000	\$2,755	\$3,301
	16	42	36	203	18	<b>VW1642WDGSOCL</b>	\$2,504	\$3,000	\$2,755	\$3,301
<ul style="list-style-type: none"> <li>• select Frosted Frameless, Frosted with Aluminum Frame or White Back Painted with Aluminum Frame</li> <li>• supported by wall cleat - hardware provided by installer</li> <li>• right door configuration - 1 door hinges left and 2 doors hinge right</li> <li>• left door configuration - 1 door hinges right and 2 doors hinge left</li> <li>• locking doors not available</li> <li>• pulls not available</li> </ul>										
<b>Double Height Wall Mount Overhead Cabinet with Two Glass Doors and Cubbies</b> 	16	36	36	188	16	<b>VW1636WDGSOC</b>	\$2,169	\$2,524	\$2,386	\$2,777
	16	30	36	180	13	<b>VW1630WDGSOC</b>	\$2,082	\$2,419	\$2,291	\$2,661
<ul style="list-style-type: none"> <li>• select Frosted Frameless, Frosted with Aluminum Frame or White Back Painted with Aluminum Frame</li> <li>• supported by wall cleat - hardware provided by installer</li> <li>• locking doors not available</li> <li>• pulls not available</li> </ul>										


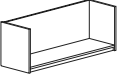
**To Order, Specify:**

- ① Model Number
- ② Wood Species - Cherry (CH1), Maple (MA1), Walnut (WA1) or Double Cut (see page 228)
- ③ Finish Color (see page 229)
- ④ Glass Option/Color (see page 237)
- ⑤ Other Product Options (see page 229)


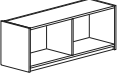
When ordering Quickship products, place a "Q" in front of model number.  
Example: QVW3072DD



VISION - VENEER

Description	D	W	H	CTN WT	CU FT	① Model	Flat Cut List Price	Double Cut List Price
Wall Mount Overhead Shelf	15 7/16	54	18	65	12	VV1554WTS	\$746	\$821
 	15 7/16	48	18	58	10	VV1548WTS	\$654	\$720
	15 7/16	42	18	51	9	VV1542WTS	\$590	\$649
	15 7/16	36	18	44	8	VV1536WTS	\$510	\$561
	15 7/16	30	18	42	7	VV1530WTS	\$496	\$546


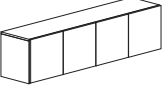
· supported by wall cleat - hardware provided by installer

Wall Mount Open Overhead	15 7/16	54	18	73	12	VV1554W00	\$1,151	\$1,267
 	15 7/16	48	18	68	10	VV1548W00	\$1,049	\$1,154
	15 7/16	42	18	61	9	VV1542W00	\$955	\$1,050
	15 7/16	36	18	53	8	VV1536W00	\$870	\$957
	15 7/16	30	18	46	7	VV1530W00	\$788	\$867

· supported by wall cleat - hardware provided by installer  
 · no center divider in 36" and 30" wide units ▲

Wall Mount Overhead Cabinet with Six Doors	16	108	18	281	23	VV16108WSO	\$2,866	\$3,153
 	16	102	18	266	22	VV16102WSO	\$2,632	\$2,895
	16	96	18	250	21	VV1696WSO	\$2,403	\$2,643
	16	90	18	235	20	VV1690WSO	\$2,291	\$2,520



· supported by wall cleat - hardware provided by installer  
 · locking doors available, specify and add \$315 list  
 · no pulls

Wall Mount Overhead Cabinet with Four Doors	16	84	18	219	18	VV1684WSO	\$2,182	\$2,401
 	16	78	18	203	17	VV1678WSO	\$2,064	\$2,271
	16	72	18	187	16	VV1672WSO	\$1,946	\$2,141
	16	66	18	174	15	VV1666WSO	\$1,860	\$2,047
	16	60	18	163	13	VV1660WSO	\$1,705	\$1,876
	16	54	18	160	12	VV1654WSO	\$1,611	\$1,773

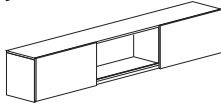
· supported by wall cleat - hardware provided by installer  
 · locking doors available, specify and add \$210 list  
 · no pulls

Wall Mount Overhead Cabinet with Three Doors	16	48	18	154	11	VV1648WSOR	\$1,397	\$1,537
 	16	48	18	154	11	VV1648WSOL	\$1,397	\$1,537
	16	42	18	142	10	VV1642WSOR	\$1,304	\$1,435
	16	42	18	142	10	VV1642WSOL	\$1,304	\$1,435

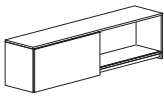
· supported by wall cleat - hardware provided by installer  
 · locking doors available, specify and add \$210 list  
 · right door configuration - 1 door hinges left and 2 doors hinge right  
 · left door configuration - 1 door hinges right and 2 doors hinge left  
 · no pulls

Wall Mount Overhead Cabinet with Two Doors	16	36	18	133	8	VV1636WSO	\$1,213	\$1,335
 	16	30	18	128	7	VV1630WSO	\$1,146	\$1,262

· supported by wall cleat - hardware provided by installer  
 · locking doors available, specify and add \$105 list  
 · no pulls

Description	D	W	H	CTN WT	CU FT	① Model	Flat Cut List Price	Double Cut List Price
<b>Wall Mount Overhead Cabinet with Two Sliding Doors</b> 	16	108	18	281	23	VV16108WSD	\$3,212	\$3,534
	16	102	18	266	22	VV16102WSD	\$3,035	\$3,338
	16	96	18	250	21	VV1696WSD	\$2,855	\$3,141
	16	90	18	235	20	VV1690WSD	\$2,678	\$2,946

• supported by wall cleat - hardware provided by installer  
 • white markerboard doors available, specify and add \$326 list  
 • locking doors not available  
 • pulls not available

<b>Wall Mount Overhead Cabinet with Sliding Door</b> 	16	84	18	219	18	VV1684WSD	\$2,498	\$2,748
	16	78	18	203	17	VV1678WSD	\$2,320	\$2,552
	16	72	18	187	16	VV1672WSD	\$2,180	\$2,399
	16	66	18	174	15	VV1666WSD	\$2,088	\$2,297
	16	60	18	163	13	VV1660WSD	\$1,986	\$2,186
	16	54	18	160	12	VV1654WSD	\$1,855	\$2,041
	16	48	18	154	11	VV1648WSD	\$1,703	\$1,874
	16	42	18	142	10	VV1642WSD	\$1,607	\$1,768
	16	36	18	133	8	VV1636WSD	\$1,522	\$1,674
	16	30	18	128	7	VV1630WSD	\$1,416	\$1,558

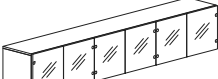
• supported by wall cleat - hardware provided by installer  
 • white markerboard doors available, specify and add \$163 list  
 • locking doors not available  
 • pulls not available

**To Order, Specify:**

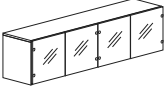
- ① Model Number
- ② Wood Species - Cherry (CH1), Maple (MA1), Walnut (WA1) or Double Cut (see page 228)
- ③ Finish Color (see page 229)
- ④ Other Product Options (see page 229)

When ordering Quickship products, place a "Q" in front of model number.  
 Example: QVV3072DD

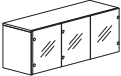


Description	D	W	H	CTN WT	CU FT	① Model	Flat Cut List		Double Cut List	
							Frameless	Aluminum Frame	Frameless	Aluminum Frame
Wall Mount Overhead with Six Glass Doors  	16	108	18	281	23	<b>VV16108WGSO</b>	\$3,177	\$4,049	\$3,495	\$4,455
	16	102	18	266	22	<b>VV16102WGSO</b>	\$2,942	\$3,801	\$3,237	\$4,182
	16	96	18	250	21	<b>VV1696WGSO</b>	\$2,750	\$3,590	\$3,026	\$3,950
	16	90	18	235	20	<b>VV1690WGSO</b>	\$2,509	\$3,334	\$2,760	\$3,668

- select Frosted Frameless, Frosted with Aluminum Frame or White Back Painted with Aluminum Frame
- supported by wall cleat - hardware provided by installer
- locking doors not available
- pulls not available

Wall Mount Overhead with Four Glass Doors  	16	84	18	219	18	<b>VV1684WGSO</b>	\$2,259	\$2,875	\$2,486	\$3,163
	16	78	18	203	17	<b>VV1678WGSO</b>	\$2,065	\$2,653	\$2,272	\$2,918
	16	72	18	187	16	<b>VV1672WGSO</b>	\$2,115	\$2,697	\$2,327	\$2,967
	16	66	18	174	15	<b>VV1666WGSO</b>	\$2,046	\$2,613	\$2,251	\$2,874
	16	60	18	163	13	<b>VV1660WGSO</b>	\$1,961	\$2,511	\$2,157	\$2,763
	16	54	18	160	12	<b>VV1654WGSO</b>	\$1,872	\$2,407	\$2,060	\$2,649

- select Frosted Frameless, Frosted with Aluminum Frame or White Back Painted with Aluminum Frame
- supported by wall cleat - hardware provided by installer
- locking doors not available
- pulls not available

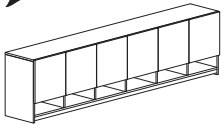
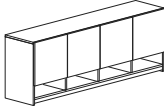
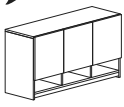

Wall Mount Overhead with Three Glass Doors  	16	48	18	154	11	<b>VV1648WGSOR</b>	\$1,689	\$2,110	\$1,858	\$2,321
	16	48	18	154	11	<b>VV1648WGSOL</b>	\$1,689	\$2,110	\$1,858	\$2,321
	16	42	18	142	10	<b>VV1642WGSOR</b>	\$1,502	\$1,904	\$1,652	\$2,095
	16	42	18	142	10	<b>VV1642WGSOL</b>	\$1,502	\$1,904	\$1,652	\$2,095

- select Frosted Frameless, Frosted with Aluminum Frame or White Back Painted with Aluminum Frame
- supported by wall cleat - hardware provided by installer
- right door configuration - 1 door hinges left and 2 doors hinge right
- left door configuration - 1 door hinges right and 2 doors hinge left
- locking doors not available
- pulls not available

Wall Mount Overhead with Two Glass Doors  	16	36	18	133	8	<b>VV1636WGSO</b>	\$1,310	\$1,602	\$1,441	\$1,762
	16	30	18	128	7	<b>VV1630WGSO</b>	\$1,247	\$1,523	\$1,372	\$1,675

- select Frosted Frameless, Frosted with Aluminum Frame or White Back Painted with Aluminum Frame
- supported by wall cleat - hardware provided by installer
- locking doors not available
- pulls not available

VISION - VENEER


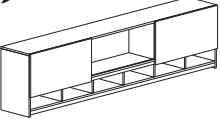
Description	D	W	H	CTN WT	CU FT	① Model	Flat Cut List Price	Double Cut List Price
<b>Wall Mount Overhead Cabinet with Six Doors and Cubbies</b> 	16	108	24	326	30	<b>VV16108WSOC</b>	\$3,699	\$4,069
	16	102	24	309	29	<b>VV16102WSOC</b>	\$3,494	\$3,843
	16	96	24	290	27	<b>VV1696WSOC</b>	\$3,288	\$3,618
	16	90	24	273	25	<b>VV1690WSOC</b>	\$3,083	\$3,392
	<ul style="list-style-type: none"> <li>supported by wall cleat - hardware provided by installer</li> <li>locking doors available, specify and add \$315 list</li> <li>no pulls</li> </ul>							
<b>Wall Mount Overhead Cabinet with Four Doors and Cubbies</b> 	16	84	24	254	24	<b>VV1684WSOC</b>	\$2,876	\$3,164
	16	78	24	236	22	<b>VV1678WSOC</b>	\$2,672	\$2,939
	16	72	24	217	21	<b>VV1672WSOC</b>	\$2,487	\$2,736
	16	66	24	202	19	<b>VV1666WSOC</b>	\$2,351	\$2,587
	16	60	24	188	17	<b>VV1660WSOC</b>	\$2,275	\$2,503
	16	54	24	183	16	<b>VV1654WSOC</b>	\$2,171	\$2,388
	<ul style="list-style-type: none"> <li>supported by wall cleat - hardware provided by installer</li> <li>locking doors available, specify and add \$210 list</li> <li>no pulls</li> </ul>							
<b>Wall Mount Overhead Cabinet with Three Doors and Cubbies</b> 	16	48	24	174	14	<b>VV1648WSOCR</b>	\$1,886	\$2,075
	16	48	24	174	14	<b>VV1648WSOCL</b>	\$1,886	\$2,075
	16	42	24	160	12	<b>VV1642WSOCR</b>	\$1,743	\$1,918
	16	42	24	160	12	<b>VV1642WSOCL</b>	\$1,743	\$1,918
	<ul style="list-style-type: none"> <li>supported by wall cleat - hardware provided by installer</li> <li>locking doors available, specify and add \$210 list</li> <li>right door configuration - 1 door hinges left and 2 doors hinge right</li> <li>left door configuration - 1 door hinges right and 2 doors hinge left</li> <li>no pulls</li> </ul>							
<b>Wall Mount Overhead Cabinet with Two Doors and Cubbies</b> 	16	36	24	148	11	<b>VV1636WSOC</b>	\$1,518	\$1,670
	16	30	24	141	9	<b>VV1630WSOC</b>	\$1,436	\$1,580
	<ul style="list-style-type: none"> <li>supported by wall cleat - hardware provided by installer</li> <li>locking doors available, specify and add \$105 list</li> <li>no pulls</li> </ul>							

**To Order, Specify:**


- ① Model Number
- ② Wood Species - Cherry (CH1), Maple (MA1), Walnut (WA1) or Double Cut (see page 228)
- ③ Finish Color (see page 229)
- ④ Glass Option/Color (see page 237)
- ⑤ Other Product Options (see page 229)

When ordering Quickship products, place a "Q" in front of model number.  
 Example: QVV3072DD


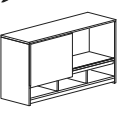


Description	D	W	H	CTN WT	CU FT	① Model	Flat Cut List Price	Double Cut List Price
<b>Wall Mount Overhead Cabinet with Two Sliding Doors and Cubbies</b>  	16	108	24	326	30	VV16108WSDC	\$3,990	\$4,389
	16	102	24	309	29	VV16102WSDC	\$3,770	\$4,147
	16	96	24	290	27	VV1696WSDC	\$3,547	\$3,902
	16	90	24	273	25	VV1690WSDC	\$3,327	\$3,660

- supported by wall cleat - hardware provided by installer
- white markerboard doors available, specify and add \$326 list
- locking doors not available
- pulls not available

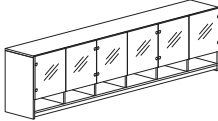
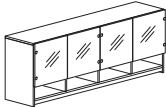
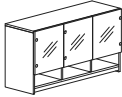

<b>Wall Mount Overhead Cabinet with Sliding Door and Cubbies</b>  	16	84	24	254	24	VV1684WSDC	\$3,104	\$3,415
	16	78	24	236	22	VV1678WSDC	\$2,882	\$3,170
	16	72	24	217	21	VV1672WSDC	\$2,721	\$2,994
	16	66	24	202	19	VV1666WSDC	\$2,586	\$2,845
	16	60	24	188	17	VV1660WSDC	\$2,508	\$2,759
	16	54	24	183	16	VV1654WSDC	\$2,342	\$2,576

- supported by wall cleat - hardware provided by installer
- white markerboard doors available, specify and add \$163 list
- locking doors not available
- pulls not available

<b>Wall Mount Overhead Cabinet with Sliding Door and Cubbies</b>  	16	48	24	174	14	VV1648WSDC	\$2,016	\$2,218
	16	42	24	160	12	VV1642WSDC	\$1,930	\$2,124
	16	36	24	148	11	VV1636WSDC	\$1,694	\$1,864
	16	30	24	141	9	VV1630WSDC	\$1,674	\$1,842

- supported by wall cleat - hardware provided by installer
- white markerboard doors available, specify and add \$163 list
- locking doors not available
- pulls not available

VISION - VENEER

Description	D	W	H	CTN WT	CU FT	① Model	Flat Cut List		Double Cut List	
							Frameless	Aluminum Frame	Frameless	Aluminum Frame
<b>Wall Mount Overhead Cabinet with Six Glass Doors and Cubbies</b> 	16	108	24	326	30	<b>VV16108WGSOC</b>	\$3,955	\$4,827	\$4,351	\$5,310
	16	102	24	309	29	<b>VV16102WGSOC</b>	\$3,751	\$4,611	\$4,127	\$5,073
	16	96	24	290	27	<b>VV1696WGSOC</b>	\$3,544	\$4,384	\$3,899	\$4,823
	16	90	24	273	25	<b>VV1690WGSOC</b>	\$3,339	\$4,165	\$3,673	\$4,582
<ul style="list-style-type: none"> <li>• select Frosted Frameless, Frosted with Aluminum Frame or White Back Painted with Aluminum Frame</li> <li>• supported by wall cleat - hardware provided by installer</li> <li>• locking doors not available</li> <li>• pulls not available</li> </ul>										
<b>Wall Mount Overhead Cabinet with Four Glass Doors and Cubbies</b> 	16	84	24	254	24	<b>VV1684WGSOC</b>	\$3,047	\$3,663	\$3,352	\$4,029
	16	78	24	236	22	<b>VV1678WGSOC</b>	\$2,841	\$3,429	\$3,125	\$3,772
	16	72	24	217	21	<b>VV1672WGSOC</b>	\$2,657	\$3,239	\$2,923	\$3,563
	16	66	24	202	19	<b>VV1666WGSOC</b>	\$2,520	\$3,087	\$2,772	\$3,396
	16	60	24	188	17	<b>VV1660WGSOC</b>	\$2,444	\$2,994	\$2,688	\$3,294
	16	54	24	183	16	<b>VV1654WGSOC</b>	\$2,340	\$2,875	\$2,574	\$3,163
<ul style="list-style-type: none"> <li>• select Frosted Frameless, Frosted with Aluminum Frame or White Back Painted with Aluminum Frame</li> <li>• supported by wall cleat - hardware provided by installer</li> <li>• locking doors not available</li> <li>• pulls not available</li> </ul>										
<b>Wall Mount Overhead Cabinet with Three Glass Doors and Cubbies</b> 	16	48	24	174	14	<b>VV1648WGSOCR</b>	\$1,983	\$2,404	\$2,181	\$2,644
	16	48	24	174	14	<b>VV1648WGSOCL</b>	\$1,983	\$2,404	\$2,181	\$2,644
	16	42	24	160	12	<b>VV1642WGSOCR</b>	\$1,799	\$2,201	\$1,980	\$2,422
	16	42	24	160	12	<b>VV1642WGSOCL</b>	\$1,799	\$2,201	\$1,980	\$2,422
<ul style="list-style-type: none"> <li>• select Frosted Frameless, Frosted with Aluminum Frame or White Back Painted with Aluminum Frame</li> <li>• supported by wall cleat - hardware provided by installer</li> <li>• right door configuration - 1 door hinges left and 2 doors hinge right</li> <li>• left door configuration - 1 door hinges right and 2 doors hinge left</li> <li>• locking doors not available</li> <li>• pulls not available</li> </ul>										
<b>Wall Mount Overhead Cabinet with Two Glass Doors and Cubbies</b> 	16	36	24	148	11	<b>VV1636WGSOC</b>	\$1,621	\$1,913	\$1,783	\$2,105
	16	30	24	141	9	<b>VV1630WGSOC</b>	\$1,563	\$1,839	\$1,719	\$2,024
<ul style="list-style-type: none"> <li>• select Frosted Frameless, Frosted with Aluminum Frame or White Back Painted with Aluminum Frame</li> <li>• supported by wall cleat - hardware provided by installer</li> <li>• locking doors not available</li> <li>• pulls not available</li> </ul>										

**To Order, Specify:**

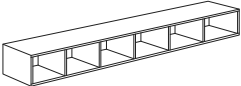
- ① Model Number
- ② Wood Species - Cherry (CH1), Maple (MA1), Walnut (WA1) or Double Cut (see page 228)
- ③ Finish Color (see page 229)
- ④ Glass Option/Color (see page 237)
- ⑤ Other Product Options (see page 229)

When ordering Quickship products, place a "Q" in front of model number.  
Example: QVV3072DD

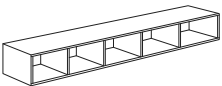


VISION - VENEER




Description	D	W	H	CTN WT	CU FT	① Model	Flat Cut List Price	Double Cut List Price
Wall Mount Cubby	13	108	10	131	12	VV10108WCU	\$1,740	\$1,915
	13	102	10	122	11	VV10102WCU	\$1,626	\$1,789
	13	96	10	113	11	VV1096WCU	\$1,511	\$1,663
	13	90	10	106	10	VV1090WCU	\$1,406	\$1,547

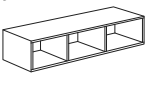
- 6 compartments
- supported by wall cleat - hardware provided by installer
- VV10108WCU interior dimensions - 11 7/16 d X 17 1/8 w X 8 1/2 h
- VV10102WCU interior dimensions - 11 7/16 d X 16 1/8 w X 8 1/2 h
- VV1096WCU interior dimensions - 11 7/16 d X 15 1/8 w X 8 1/2 h
- VV1090WCU interior dimensions - 11 7/16 d X 14 1/8 w X 8 1/2 h

Wall Mount Cubby	13	84	10	98	9	VV1084WCU	\$1,293	\$1,423
	13	78	10	89	9	VV1078WCU	\$1,192	\$1,312


- 5 compartments
- supported by wall cleat - hardware provided by installer
- VV1084WCU interior dimensions - 11 7/16 d X 15 7/8 w X 8 1/2 h
- VV1078WCU interior dimensions - 11 7/16 d X 14 3/4 w X 8 1/2 h

Wall Mount Cubby	13	72	10	81	8	VV1072WCU	\$1,101	\$1,211
	13	66	10	74	8	VV1066WCU	\$1,010	\$1,111
	13	60	10	68	7	VV1060WCU	\$929	\$1,022

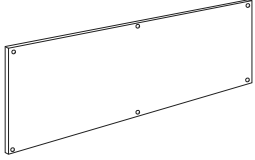
- 4 compartments
- supported by wall cleat - hardware provided by installer
- VV1072WCU interior dimensions - 11 7/16 d X 17 1/16 w X 8 1/2 h
- VV1066WCU interior dimensions - 11 7/16 d X 15 9/16 w X 8 1/2 h
- VV1060WCU interior dimensions - 11 7/16 d X 14 1/16 w X 8 1/2 h

Wall Mount Cubby	13	54	10	62	6	VV1054WCU	\$856	\$942
	13	48	10	53	6	VV1048WCU	\$790	\$870

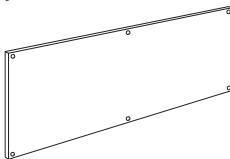
- 3 compartments
- supported by wall cleat - hardware provided by installer
- VV1054WCU interior dimensions - 11 7/16 d X 17 w X 8 1/2 h
- VV1048WCU interior dimensions - 11 7/16 d X 15 w X 8 1/2 h

Wall Mount Cubby	13	42	10	47	5	VV1042WCU	\$724	\$796
	13	36	10	42	4	VV1036WCU	\$664	\$731
	13	30	10	37	4	VV1030WCU	\$612	\$674

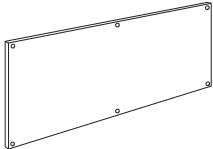
- 2 compartments
- supported by wall cleat - hardware provided by installer
- VV1042WCU interior dimensions - 11 7/16 d X 19 7/8 w X 8 1/2 h
- VV1036WCU interior dimensions - 11 7/16 d X 16 7/8 w X 8 1/2 h
- VV1030WCU interior dimensions - 11 7/16 d X 13 7/8 w X 8 1/2 h

Description	D	W	H	CTN WT	CU FT	① Model	List Price Per Grade
<b>84" w Wall Mount Tackboard for Overhead Cabinet</b> 	7/8	83 3/4	21 1/2	19	8	<b>VS8420WT</b>	<b>COM \$353</b> A \$381 B \$434 C \$529 D \$649 E \$770 F \$959 G \$1,161 H \$1,375 I \$1,711 J \$2,114

- Culp Montgomery Sterling panel fabric standard, use Grade A pricing
- other fabrics available, contact Customer Service
- attaches with covered button screws
- com ydg: 2 3/4

<b>78" w Wall Mount Tackboard for Overhead Cabinet</b> 	7/8	77 3/4	21 1/2	18	7	<b>VS7820WT</b>	<b>COM \$349</b> A \$374 B \$423 C \$509 D \$619 E \$728 F \$899 G \$1,083 H \$1,278 I \$1,584 J \$1,950
---	-----	--------	--------	----	---	-----------------	--

- Culp Montgomery Sterling panel fabric standard, use Grade A pricing
- other fabrics available, contact Customer Service
- attaches with covered button screws
- com ydg: 2 1/2

<b>72" w Wall Mount Tackboard for Overhead Cabinet</b> 	7/8	71 3/4	21 1/2	16	6	<b>VS7220WT</b>	<b>COM \$332</b> A \$355 B \$398 C \$476 D \$575 E \$674 F \$828 G \$993 H \$1,168 I \$1,443 J \$1,773
---	-----	--------	--------	----	---	-----------------	--


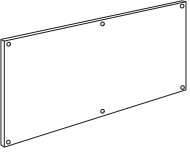

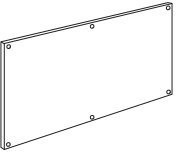

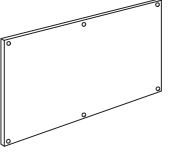

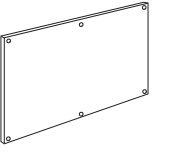
- Culp Montgomery Sterling panel fabric standard, use Grade A pricing
- other fabrics available, contact Customer Service
- attaches with covered button screws
- com ydg: 2 1/4

**To Order, Specify:**

- ① Model Number
- ② Wood Species - Cherry (CH1), Maple (MA1), Walnut (WA1) or Double Cut (see page 228)
- ③ Finish Color (see page 229)
- ④ Fabric Selection: vendor, pattern, color
- ⑤ Other Product Options (see page 229)

When ordering Quickship products, place a "Q" in front of model number.  
 Example: QV3072DD



Description	D	W	H	CTN WT	CU FT	① Model	List Price Per Grade
<b>66" w Wall Mount Tackboard for Overhead Cabinet</b>  	7/8	65 3/4	21 1/2	15	6	VS6620WT	COM \$313
							A \$333
							B \$372
							C \$441
							D \$529
							E \$617
							F \$753
							G \$900
							H \$1,057
							I \$1,301
J \$1,594							
<b>60" w Wall Mount Tackboard for Overhead Cabinet</b>  	7/8	59 3/4	21 1/2	14	5	VS6020WT	COM \$309
							A \$329
							B \$368
							C \$437
							D \$524
							E \$613
							F \$749
							G \$896
							H \$1,053
							I \$1,297
J \$1,590							
<b>54" w Wall Mount Tackboard for Overhead Cabinet</b>  	7/8	53 3/4	21 1/2	13	5	VS5420WT	COM \$291
							A \$309
							B \$343
							C \$403
							D \$480
							E \$557
							F \$677
							G \$805
							H \$942
							I \$1,155
J \$1,412							
<b>48" w Wall Mount Tackboard for Overhead Cabinet</b>  	7/8	47 3/4	21 1/2	12	4	VS4820WT	COM \$286
							A \$304
							B \$338
							C \$397
							D \$475
							E \$552
							F \$671
							G \$800
							H \$937
							I \$1,150
J \$1,406							

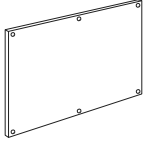
- Culp Montgomery Sterling panel fabric standard, use Grade A pricing
- other fabrics available, contact Customer Service
- attaches with covered button screws
- com ydg: 2

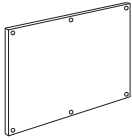
- Culp Montgomery Sterling panel fabric standard, use Grade A pricing
- other fabrics available, contact Customer Service
- attaches with covered button screws
- com ydg: 2

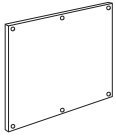
- Culp Montgomery Sterling panel fabric standard, use Grade A pricing
- other fabrics available, contact Customer Service
- attaches with covered button screws
- com ydg: 1 3/4

- Culp Montgomery Sterling panel fabric standard, use Grade A pricing
- other fabrics available, contact Customer Service
- attaches with covered button screws
- com ydg: 1 3/4

VISION - VENEER

Description	D	W	H	CTN WT	CU FT	① Model	List Price Per Grade	
<b>42" w Wall Mount Tackboard for Overhead Cabinet</b> 	7/8	41 3/4	21 1/2	11	4	<b>VS4220WT</b>	<b>COM</b> \$269	
	<ul style="list-style-type: none"> <li>· Culp Montgomery Sterling panel fabric standard, use Grade A pricing</li> <li>· other fabrics available, contact Customer Service</li> <li>· attaches with covered button screws</li> <li>· com ydg: 1 1/2</li> </ul>							A \$285
								B \$313
								C \$365
								D \$431
								E \$497
								F \$600
								G \$709
								H \$827
								I \$1,011
							J \$1,230	

<b>36" w Wall Mount Tackboard for Overhead Cabinet</b> 	7/8	35 3/4	21 1/2	10	3	<b>VS3620WT</b>	<b>COM</b> \$247	
	<ul style="list-style-type: none"> <li>· Culp Montgomery Sterling panel fabric standard, use Grade A pricing</li> <li>· other fabrics available, contact Customer Service</li> <li>· attaches with covered button screws</li> <li>· com ydg: 1 1/4</li> </ul>							A \$260
								B \$284
								C \$327
								D \$383
								E \$437
								F \$522
								G \$615
								H \$712
								I \$865
							J \$1,048	

<b>30" w Wall Mount Tackboard for Overhead Cabinet</b> 	7/8	29 3/4	21 1/2	10	2	<b>VS3020WT</b>	<b>COM</b> \$228	
	<ul style="list-style-type: none"> <li>· Culp Montgomery Sterling panel fabric standard, use Grade A pricing</li> <li>· other fabrics available, contact Customer Service</li> <li>· attaches with covered button screws</li> <li>· com ydg: 1 1/4</li> </ul>							A \$241
								B \$265
								C \$308
								D \$364
								E \$418
								F \$503
								G \$596
								H \$693
								I \$846
							J \$1,029	

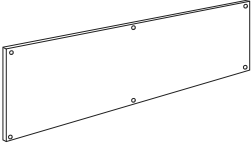
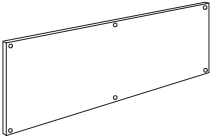
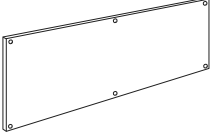
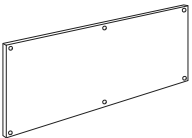
**To Order, Specify:**

- ① Model Number
- ② Fabric Selection: vendor, pattern, color

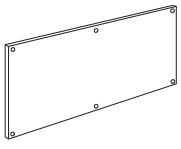
When ordering Quickship products, place a "Q" in front of model number.  
Example: QV3072DD

**NOW!**  
Need it.  
JSI Quickship

VISION - VENEER

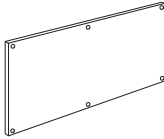
Description	D	W	H	CTN WT	CU FT	① Model	List Price Per Grade
<b>84" w Wall Mount Tackboard for Overhead Cabinet with Cubbies</b> 	7/8	83 3/4	15 1/2	19	8	<b>VS8420WTC</b>	<b>COM \$353</b> A \$381 B \$434 C \$529 D \$649 E \$770 F \$959 G \$1,161 H \$1,375 I \$1,711 J \$2,114
<ul style="list-style-type: none"> <li>· Culp Montgomery Sterling panel fabric standard, use Grade A pricing</li> <li>· other fabrics available, contact Customer Service</li> <li>· attaches with covered button screws</li> <li>· com ydg: 2 3/4</li> </ul>							
<b>78" w Wall Mount Tackboard for Overhead Cabinet with Cubbies</b> 	7/8	77 3/4	15 1/2	18	7	<b>VS7820WTC</b>	<b>COM \$349</b> A \$374 B \$423 C \$509 D \$619 E \$728 F \$899 G \$1,083 H \$1,278 I \$1,584 J \$1,950
<ul style="list-style-type: none"> <li>· Culp Montgomery Sterling panel fabric standard, use Grade A pricing</li> <li>· other fabrics available, contact Customer Service</li> <li>· attaches with covered button screws</li> <li>· com ydg: 2 1/2</li> </ul>							
<b>72" w Wall Mount Tackboard for Overhead Cabinet with Cubbies</b> 	7/8	71 3/4	15 1/2	16	6	<b>VS7220WTC</b>	<b>COM \$332</b> A \$355 B \$398 C \$476 D \$575 E \$674 F \$828 G \$993 H \$1,168 I \$1,443 J \$1,773
<ul style="list-style-type: none"> <li>· Culp Montgomery Sterling panel fabric standard, use Grade A pricing</li> <li>· other fabrics available, contact Customer Service</li> <li>· attaches with covered button screws</li> <li>· com ydg: 2 1/4</li> </ul>							
<b>66" w Wall Mount Tackboard for Overhead Cabinet with Cubbies</b> 	7/8	65 3/4	15 1/2	15	6	<b>VS6620WTC</b>	<b>COM \$313</b> A \$333 B \$372 C \$441 D \$529 E \$617 F \$753 G \$900 H \$1,057 I \$1,301 J \$1,594
<ul style="list-style-type: none"> <li>· Culp Montgomery Sterling panel fabric standard, use Grade A pricing</li> <li>· other fabrics available, contact Customer Service</li> <li>· attaches with covered button screws</li> <li>· com ydg: 2</li> </ul>							

VISION - VENEER

Description	D	W	H	CTN WT	CU FT	① Model	List Price Per Grade
<b>60" w Wall Mount Tackboard for Overhead Cabinet with Cubbies</b> 	7/8	59 3/4	15 1/2	14	5	VS6020WTC	COM \$309
							A \$329
							B \$368
							C \$437
							D \$524
							E \$613
							F \$749
							G \$896
							H \$1,053
							I \$1,297
J \$1,590							

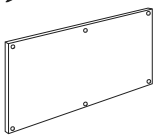
- Culp Montgomery Sterling panel fabric standard, use Grade A pricing
- other fabrics available, contact Customer Service
- attaches with covered button screws
- com ydg: 2

**NOW!**

<b>54" w Wall Mount Tackboard for Overhead Cabinet with Cubbies</b> 	7/8	53 3/4	15 1/2	13	5	VS5420WTC	COM \$291
							A \$309
							B \$343
							C \$403
							D \$480
							E \$557
							F \$677
							G \$805
							H \$942
							I \$1,155
J \$1,412							

- Culp Montgomery Sterling panel fabric standard, use Grade A pricing
- other fabrics available, contact Customer Service
- attaches with covered button screws
- com ydg: 1 3/4

**NOW!**

<b>48" w Wall Mount Tackboard for Overhead Cabinet with Cubbies</b> 	7/8	47 3/4	15 1/2	12	4	VS4820WTC	COM \$286
							A \$304
							B \$338
							C \$397
							D \$475
							E \$552
							F \$671
							G \$800
							H \$937
							I \$1,150
J \$1,406							

- Culp Montgomery Sterling panel fabric standard, use Grade A pricing
- other fabrics available, contact Customer Service
- attaches with covered button screws
- com ydg: 1 3/4

**NOW!**


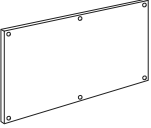
**To Order, Specify:**

- ① Model Number
- ② Fabric Selection: vendor, pattern, color


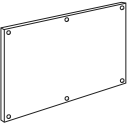
When ordering Quickship products, place a "Q" in front of model number.  
Example: QV3072DD

**NOW!**  
Need it.  
JSI Quickship


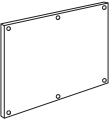
VISION - VENEER

Description	D	W	H	CTN WT	CU FT	① Model	List Price Per Grade
<b>42" w Wall Mount Tackboard for Overhead Cabinet with Cubbies</b>  	7/8	41 3/4	15 1/2	11	4	<b>VS4220WTC</b>	<b>COM</b> \$269
							A \$285
							B \$313
							C \$365
							D \$431
							E \$497
							F \$600
							G \$709
							H \$827
							I \$1,011
						J \$1,230	


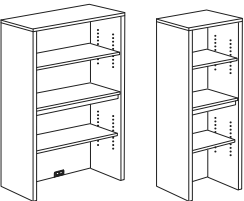
- Culp Montgomery Sterling panel fabric standard, use Grade A pricing
- other fabrics available, contact Customer Service
- attaches with covered button screws
- com ydg: 1 1/2

<b>36" w Wall Mount Tackboard for Overhead Cabinet with Cubbies</b>  	7/8	35 3/4	15 1/2	10	3	<b>VS3620WTC</b>	<b>COM</b> \$247
							A \$260
							B \$284
							C \$327
							D \$383
							E \$437
							F \$522
							G \$615
							H \$712
							I \$865
						J \$1,048	

- Culp Montgomery Sterling panel fabric standard, use Grade A pricing
- other fabrics available, contact Customer Service
- attaches with covered button screws
- com ydg: 1 1/4

<b>30" w Wall Mount Tackboard for Overhead Cabinet with Cubbies</b>  	7/8	29 3/4	15 1/2	10	2	<b>VS3020WTC</b>	<b>COM</b> \$228
							A \$241
							B \$265
							C \$308
							D \$364
							E \$418
							F \$503
							G \$596
							H \$693
							I \$846
						J \$1,029	

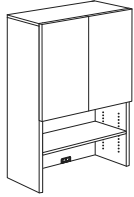
- Culp Montgomery Sterling panel fabric standard, use Grade A pricing
- other fabrics available, contact Customer Service
- attaches with covered button screws
- com ydg: 1 1/4

Description	D	W	H	CTN WT	CU FT	① Model	Flat Cut List Price	Double Cut List Price
<b>Double Height Bookcase Overhead</b>  	15 7/16	36	54	102	22	<b>VV1636DBO</b>	\$1,375	\$1,512
	15 7/16	30	54	98	19	<b>VV1630DBO</b>	\$1,254	\$1,380
	15 7/16	18	54	54	12	<b>VV1618DBO</b>	\$971	\$1,068

- one fixed shelf, two adjustable shelves
- one back panel grommet
- backside of unit intended to go against a wall, cabinet should be secured to a wall as a safety precaution

Description	D	W	H	CTN WT	CU FT	① Model	Flat Cut	Double Cut
							List Price	List Price
Double Height Storage Tower with 29" h Doors	16	36	54	117	23	WV1636DSB	\$1,817	\$1,999
	16	30	54	104	19	WV1630DSB	\$1,484	\$1,633

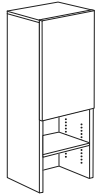
**NOW!**



- 29" door height
- one fixed shelf, two adjustable shelves
- one back panel grommet
- non-locking
- no pulls
- backside of unit intended to go against a wall, cabinet should be secured to a wall as a safety precaution

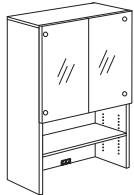
Double Height Storage Tower with 29" h Door	16	18	54	59	12	WV1618DSBR	\$1,166	\$1,283
	16	18	54	59	12	WV1618DSBL	\$1,166	\$1,283

**NOW!**



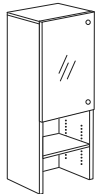
- 29" door height
- one fixed shelf, two adjustable shelves
- one back panel grommet
- non-locking
- no pull
- backside of unit intended to go against a wall, cabinet should be secured to a wall as a safety precaution

Description	D	W	H	CTN WT	CU FT	① Model	Flat Cut List		Double Cut List	
							Frameless	Aluminum Frame	Frameless	Aluminum Frame
Double Height Storage Tower with 29" h Glass Doors	16	36	54	117	23	WV1636DGSB	\$1,997	\$2,351	\$2,197	\$2,587
	16	30	54	104	19	WV1630DGSB	\$1,663	\$2,000	\$1,830	\$2,200



- select Frosted Frameless, Frosted with Aluminum Frame or White Back Painted with Aluminum Frame
- 29" door height
- one fixed shelf, two adjustable shelves
- one back panel grommet
- locking doors not available
- pulls not available
- backside of unit intended to go against a wall, cabinet should be secured to a wall as a safety precaution

Double Height Storage Tower with 29" h Glass Door	16	18	54	59	12	WV1618DGSBR	\$1,343	\$1,522	\$1,478	\$1,674
	16	18	54	59	12	WV1618DGSBL	\$1,343	\$1,522	\$1,478	\$1,674



right shown

- select Frosted Frameless, Frosted with Aluminum Frame or White Back Painted with Aluminum Frame
- 29" door height
- one fixed shelf, two adjustable shelves
- one back panel grommet
- locking door not available
- pull not available
- backside of unit intended to go against a wall, cabinet should be secured to a wall as a safety precaution

**To Order, Specify:**

- ① Model Number
- ② Wood Species - Cherry (CH1), Maple (MA1), Walnut (WA1) or Double Cut (see page 228)
- ③ Finish Color (see page 229)
- ④ Glass Option/Color (see page 237)

- ⑤ Knob Color - Matte Black (MBK) or Matte Nickel (MNK) (see page 233) ▲
- ⑥ Grommet Color - Matte Black (MBK) or Stardust Silver (STS) (see page 234)
- ⑦ Fabric Selection: vendor, pattern, color
- ⑧ Other Product Options (see page 229)

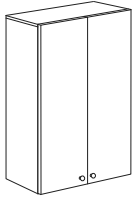
When ordering Quickship products, place a "Q" in front of model number.  
Example: QVW3072DD

**NOW!**  
Need it.  
JSI Quickship



Description	D	W	H	CTN WT	CU FT	① Model	Flat Cut List Price	Double Cut List Price
Double Height Storage Tower with 54" h Doors	16	36	54	129	23	VV1636DSTD	\$1,863	\$2,050
	16	30	54	115	19	VV1630DSTD	\$1,630	\$1,794

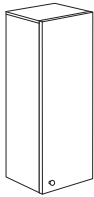
**NOW!**



- 54" door height
- one fixed shelf, two adjustable shelves
- one back panel grommet
- locking doors available, specify and add \$105 list
- pull knobs

Double Height Storage Tower with 54" h Door	16	18	54	67	12	VV1618DSTDR	\$1,182	\$1,300
	16	18	54	67	12	VV1618DSTDL	\$1,182	\$1,300

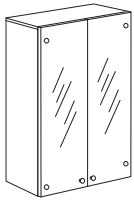
**NOW!**



- 54" door height
- one fixed shelf, two adjustable shelves
- one back panel grommet
- locking door available, specify and add \$105 list
- pull knob

right shown

Description	D	W	H	CTN WT	CU FT	① Model	Flat Cut List Price		Double Cut List	
							Frameless	Aluminum Frame	Frameless	Aluminum Frame
Double Height Storage Tower with 54" h Glass Doors	16	36	54	129	23	VV1636DGSTD	\$2,084	\$2,571	\$2,293	\$2,828
	16	30	54	115	19	VV1630DGSTD	\$1,788	\$2,254	\$1,967	\$2,480



- select Frosted Frameless, Frosted with Aluminum Frame or White Back Painted with Aluminum Frame
- 54" door height
- one fixed shelf, two adjustable shelves
- one back panel grommet
- locking doors not available
- pull knobs

Double Height Storage Tower with 54" h Glass Door	16	18	54	67	12	VV1618DGSTDR	\$1,404	\$1,649	\$1,545	\$1,814
	16	18	54	67	12	VV1618DGSTDL	\$1,404	\$1,649	\$1,545	\$1,814

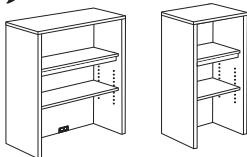


- select Frosted Frameless, Frosted with Aluminum Frame or White Back Painted with Aluminum Frame
- 54" door height
- one fixed shelf, two adjustable shelves
- one back panel grommet
- locking door not available
- pull knob

right shown

Description	D	W	H	CTN WT	CU FT	① Model	Flat Cut List Price	Double Cut List Price
Bookcase Overhead	15 <sup>7</sup> / <sub>16</sub>	36	42	78	13	VV1636B0	\$1,035	\$1,139
	15 <sup>7</sup> / <sub>16</sub>	30	42	75	13	VV1630B0	\$908	\$999
	15 <sup>7</sup> / <sub>16</sub>	18	42	41	9	VV1618B0	\$800	\$880

**NOW!**



- fixed shelf on top, adjustable shelf on bottom
- one back panel grommet

Description	D	W	H	CTN WT	CU FT	① Model	Flat Cut		Double Cut	
							List Price	List Price	List Price	List Price
Storage Tower with 17" h Doors	16	36	42	90	13	WV1636SB	\$1,397		\$1,537	
	16	30	42	80	13	WV1630SB	\$1,212		\$1,334	

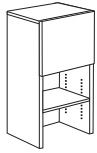
NOW!



- 17" door height
- adjustable shelf
- one back panel grommet
- no pulls
- locking doors available, specify and add \$105 list

Storage Tower with 17" h Door	16	18	42	45	9	WV1618SBR	\$896		\$986	
	16	18	42	45	9	WV1618SBL	\$896		\$986	

NOW!



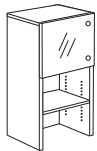
- 17" door height
- adjustable shelf
- one back panel grommet
- no pull
- locking doors available, specify and add \$105 list

Description	D	W	H	CTN WT	CU FT	① Model	Flat Cut List		Double Cut List	
							Frameless	Aluminum Frame	Frameless	Aluminum Frame
Storage Tower with 17" h Glass Doors	16	36	42	90	13	WV1636GSB	\$1,536	\$1,827	\$1,690	\$2,010
	16	30	42	80	13	WV1630GSB	\$1,338	\$1,614	\$1,473	\$1,776



- select Frosted Frameless, Frosted with Aluminum Frame or White Back Painted with Aluminum Frame
- 17" door height
- adjustable shelf
- one back panel grommet
- pulls not available
- locking doors not available

Storage Tower with 17" h Glass Door	16	18	42	45	9	WV1618GSBR	\$1,080	\$1,227	\$1,188	\$1,350
	16	18	42	45	9	WV1618GSBL	\$1,080	\$1,227	\$1,188	\$1,350



right shown

- select Frosted Frameless, Frosted with Aluminum Frame or White Back Painted with Aluminum Frame
- 17" door height
- adjustable shelf
- one back panel grommet
- pull not available
- locking door not available

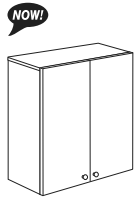
**To Order, Specify:**

- ① Model Number
- ② Wood Species - Cherry (CH1), Maple (MA1), Walnut (WA1) or Double Cut (see page 228)
- ③ Finish Color (see page 229)
- ④ Glass Option/Color (see page 237)
- ⑤ Knob Color - Matte Black (MBK) or Matte Nickel (MNK) (see page 233) ▲
- ⑥ Grommet Color - Matte Black (MBK) or Stardust Silver (STS) (see page 234)
- ⑦ Other Product Options (see page 229)

When ordering Quickship products, place a "Q" in front of model number.  
Example: QVW3072DD

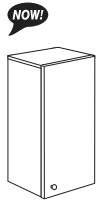
**NOW!**  
Need it.  
JSI Quickship

Description	D	W	H	CTN WT	CU FT	① Model	Flat Cut List Price	Double Cut List Price
Storage Tower with 42" h Doors	16	36	42	99	13	VV1636STD	\$1,433	\$1,577
	16	30	42	88	13	VV1630STD	\$1,264	\$1,391



- 42" door height
- adjustable shelf
- one back panel grommet
- locking doors available, specify and add \$105 list
- pull knobs

Storage Tower with 42" h Door	16	18	42	51	9	VV1618STDR	\$997	\$1,097
	16	18	42	51	9	VV1618STD L	\$997	\$1,097

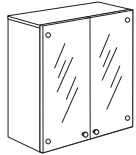


- 42" door height
- adjustable shelf
- one back panel grommet
- locking doors available, specify and add \$105 list
- pull knob

right shown

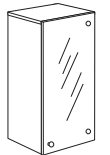
VISION - VENEER

Description	D	W	H	CTN WT	CU FT	① Model	Flat Cut List		Double Cut List	
							Frameless	Aluminum Frame	Frameless	Aluminum Frame
Storage Tower with 42" h Glass Doors	16	36	42	99	13	VV1636GSTD	\$1,603	\$2,027	\$1,763	\$2,230
	16	30	42	88	13	VV1630GSTD	\$1,400	\$1,799	\$1,541	\$1,980



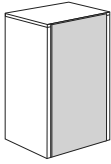
- select Frosted Frameless, Frosted with Aluminum Frame or White Back Painted with Aluminum Frame
- 42" door height
- adjustable shelf
- one back panel grommet
- locking doors not available
- pull knobs

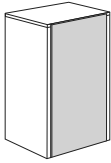
Storage Tower with 42" h Glass Door	16	18	42	51	9	VV1618GSTDR	\$1,190	\$1,403	\$1,310	\$1,544
	16	18	42	51	9	VV1618GSTDL	\$1,190	\$1,403	\$1,310	\$1,544

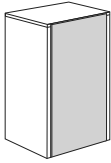


- select Frosted Frameless, Frosted with Aluminum Frame or White Back Painted with Aluminum Frame
- 42" door height
- adjustable shelf
- one back panel grommet
- locking door not available
- pull knob

right shown

Description	D	W	H	CTN WT	CU FT	① Model	List Price Per Grade
<b>36" w Fabric Back Panel for Storage Tower</b> 	3/8	34	42	8	5	VS3642STB	<b>COM \$258</b> A \$270 B \$294 C \$338 D \$393 E \$448 F \$533 G \$625 H \$723 I \$875 J \$1,059
• for use with 36" wide storage tower • Culp Montgomery Sterling panel fabric standard, use Grade A pricing • other fabrics available, contact Customer Service • attaches with covered button screws • ships attached when ordered with storage towers • com ydg: 1 1/4							

<b>30" w Fabric Back Panel for Storage Tower</b> 	3/8	28	42	7	4	VS3042STB	<b>COM \$230</b> A \$243 B \$267 C \$310 D \$366 E \$420 F \$506 G \$598 H \$696 I \$848 J \$1,032
• for use with 30" wide storage tower • Culp Montgomery Sterling panel fabric standard, use Grade A pricing • other fabrics available, contact Customer Service • attaches with covered button screws • ships attached when ordered with storage towers • com ydg: 1 1/4							

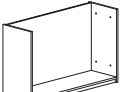
<b>18" w Fabric Back Panel for Storage Tower</b> 	3/8	16	42	4	2	VS1842STB	<b>COM \$180</b> A \$188 B \$202 C \$228 D \$261 E \$294 F \$346 G \$401 H \$459 I \$551 J \$661
• for use with 18" wide storage tower • Culp Montgomery Sterling panel fabric standard, use Grade A pricing • other fabrics available, contact Customer Service • attaches with covered button screws • ships attached when ordered with storage towers • com ydg: 3/4							

**To Order, Specify:**

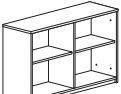
- ① Model Number
- ② Wood Species - Cherry (CH1), Maple (MA1), Walnut (WA1) or Double Cut (see page 228)
- ③ Finish Color (see page 229)
- ④ Glass Option/Color (see page 237)
- ⑤ Knob Color - Matte Black (MBK) or Matte Nickel (MNK) (see page 233) ▲
- ⑥ Fabric Selection: vendor, pattern, color
- ⑦ Other Product Options (see page 229)

When ordering Quickship products, place a "Q" in front of model number.  
 Example: QVV3072DD

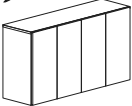
**NOW!**  
*Need it.*  
 JSI Quickship

Description	D	W	H	CTN WT	CU FT	① Model	Flat Cut List Price	Double Cut List Price
<b>Double Height Bridge Mount Overhead Shelf</b> 	15 7/16	54	30	81	19	VV1554DBTS	\$895	\$985
	15 7/16	48	30	72	17	VV1548DBTS	\$784	\$864
	15 7/16	42	30	63	15	VV1542DBTS	\$707	\$779
	15 7/16	36	30	54	13	VV1536DBTS	\$611	\$672
	15 7/16	30	30	51	11	VV1530DBTS	\$592	\$651

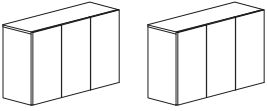
· must be supported by two storage towers

<b>Double Height Bridge Mount Open Overhead</b> 	15 7/16	54	30	95	19	VV1554DB00	\$1,381	\$1,520
	15 7/16	48	30	89	17	VV1548DB00	\$1,259	\$1,385
	15 7/16	42	30	80	15	VV1542DB00	\$1,146	\$1,260
	15 7/16	36	30	69	13	VV1536DB00	\$1,044	\$1,148
	15 7/16	30	30	60	11	VV1530DB00	\$945	\$1,040

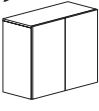
· must be supported by two storage towers

<b>Double Height Bridge Mount Overhead Cabinet with Four Doors</b> 	16	54	30	205	19	VV1654DBMS	\$2,076	\$2,284
---	----	----	----	-----	----	------------	---------	---------

· must be supported by two storage towers  
 · locking doors available, specify and add \$210 list  
 · no pulls

<b>Double Height Bridge Mount Overhead Cabinet with Three Doors</b> 	16	48	30	195	17	VV1648DBMSR	\$1,817	\$1,999
	16	48	30	195	17	VV1648DBMSL	\$1,817	\$1,999
	16	42	30	181	15	VV1642DBMSR	\$1,668	\$1,835
	16	42	30	181	15	VV1642DBMSL	\$1,668	\$1,835

· must be supported by two storage towers  
 · locking doors available, specify and add \$210 list  
 · right door configuration - 1 door hinges left and 2 doors hinge right  
 · left door configuration - 1 door hinges right and 2 doors hinge left  
 · no pulls

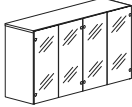
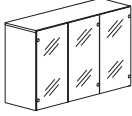
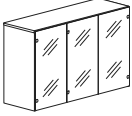
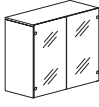
<b>Double Height Bridge Mount Overhead Cabinet with Two Doors</b> 	16	36	30	169	13	VV1636DBMS	\$1,564	\$1,720
	16	30	30	163	11	VV1630DBMS	\$1,489	\$1,638

· must be supported by two storage towers  
 · locking doors available, specify and add \$105 list  
 · no pulls

<b>Double Height Bridge Mount Overhead Cabinet with Sliding Door</b> 	16	54	30	208	19	VV1654DBMSSD	\$2,534	\$2,788
	16	48	30	201	17	VV1648DBMSSD	\$2,270	\$2,497
	16	42	30	185	15	VV1642DBMSSD	\$2,175	\$2,393
	16	36	30	173	13	VV1636DBMSSD	\$2,012	\$2,214
	16	30	30	167	11	VV1630DBMSSD	\$1,988	\$2,188

· must be supported by two storage towers  
 · white markerboard doors available, specify and add \$216 list  
 · locking doors not available  
 · pulls not available

VISION - VENEER

Description	D	W	H	CTN WT	CU FT	① Model	Flat Cut List		Double Cut List	
							Frameless	Aluminum Frame	Frameless	Aluminum Frame
<b>Double Height Bridge Mount Overhead Cabinet with Four Glass Doors</b>  <ul style="list-style-type: none"> <li>· select Frosted Frameless, Frosted with Aluminum Frame or White Back Painted with Aluminum Frame</li> <li>· must be supported by two storage towers</li> <li>· locking doors not available</li> <li>· pulls not available</li> </ul>	16	54	30	205	19	<b>WV1654DGBMS</b>	\$2,495	\$3,153	\$2,745	\$3,469
<b>Double Height Bridge Mount Overhead Cabinet with Three Glass Doors</b>   <p style="display: flex; justify-content: space-around; margin-top: 5px;"> <span>right</span> <span>left</span> </p> <ul style="list-style-type: none"> <li>· select Frosted Frameless, Frosted with Aluminum Frame or White Back Painted with Aluminum Frame</li> <li>· must be supported by two storage towers</li> <li>· right door configuration - 1 door hinges left and 2 doors hinge right</li> <li>· left door configuration - 1 door hinges right and 2 doors hinge left</li> <li>· locking doors not available</li> <li>· pulls not available</li> </ul>	16	48	30	195	17	<b>WV1648DGBMSR</b>	\$2,224	\$2,740	\$2,447	\$3,014
	16	48	30	195	17	<b>WV1648DGBMSL</b>	\$2,224	\$2,740	\$2,447	\$3,014
	16	42	30	181	15	<b>WV1642DGBMSR</b>	\$2,042	\$2,538	\$2,246	\$2,792
	16	42	30	181	15	<b>WV1642DGBMSL</b>	\$2,042	\$2,538	\$2,246	\$2,792
<b>Double Height Bridge Mount Overhead with Glass Doors</b>  <ul style="list-style-type: none"> <li>· select Frosted Frameless, Frosted with Aluminum Frame or White Back Painted with Aluminum Frame</li> <li>· must be supported by two storage towers</li> <li>· locking doors not available</li> <li>· pulls not available</li> </ul>	16	36	30	169	13	<b>WV1636DGBMS</b>	\$1,817	\$2,172	\$1,999	\$2,389
	16	30	30	163	11	<b>WV1630DGBMS</b>	\$1,713	\$2,050	\$1,885	\$2,256


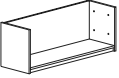
VISION - VENEER

**To Order, Specify:**


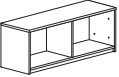
- ① Model Number
- ② Wood Species - Cherry (CH1), Maple (MA1), Walnut (WA1) or Double Cut (see page 228)
- ③ Finish Color (see page 229)
- ④ Glass Option/Color (see page 237)
- ⑤ Other Product Options (see page 229)

When ordering Quickship products, place a "Q" in front of model number.  
Example: QVV3072DD


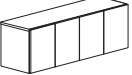


Description	D	W	H	CTN WT	CU FT	① Model	Flat Cut List Price	Double Cut List Price
<b>Bridge Mount Overhead Shelf</b>  	15 7/16	54	18	62	12	VV1554BTS	\$746	\$821
	15 7/16	48	18	55	11	VV1548BTS	\$654	\$720
	15 7/16	42	18	48	10	VV1542BTS	\$590	\$649
	15 7/16	36	18	41	8	VV1536BTS	\$510	\$561
	15 7/16	30	18	39	7	VV1530BTS	\$496	\$546

· must be supported by two storage towers

<b>Bridge Mount Open Overhead</b>  	15 7/16	54	18	73	12	VV1554B00	\$1,151	\$1,267
	15 7/16	48	18	68	11	VV1548B00	\$1,049	\$1,154
	15 7/16	42	18	61	10	VV1542B00	\$955	\$1,050
	15 7/16	36	18	53	8	VV1536B00	\$870	\$957
	15 7/16	30	18	46	7	VV1530B00	\$788	\$867



· must be supported by two storage towers

<b>Bridge Mount Overhead Cabinet with Four Doors</b>  	16	54	18	157	12	VV1654BMS	\$1,611	\$1,773
--	----	----	----	-----	----	-----------	---------	---------


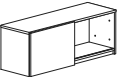
· must be supported by two storage towers  
 · locking doors available, specify and add \$210 list  
 · no pulls

<b>Bridge Mount Overhead Cabinet with Three Doors</b>   right      left	16	48	18	150	11	VV1648BMSR	\$1,397	\$1,537
	16	48	18	150	11	VV1648BMSL	\$1,397	\$1,537
	16	42	18	139	10	VV1642BMSR	\$1,304	\$1,435
	16	42	18	139	10	VV1642BMSL	\$1,304	\$1,435

· must be supported by two storage towers  
 · locking doors available, specify and add \$210 list  
 · right door configuration - 1 door hinges left and 2 doors hinge right  
 · left door configuration - 1 door hinges right and 2 doors hinge left  
 · no pulls

<b>Bridge Mount Overhead Cabinet with Two Doors</b>  	16	36	18	130	8	VV1636BMS	\$1,213	\$1,335
	16	30	18	125	7	VV1630BMS	\$1,146	\$1,262

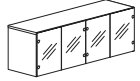
· must be supported by two storage towers  
 · locking doors available, specify and add \$105 list  
 · no pulls

<b>Bridge Mount Overhead Cabinet with Sliding Door</b>  	16	54	18	160	12	VV1654BMSSD	\$1,855	\$2,041
	16	48	18	154	11	VV1648BMSSD	\$1,703	\$1,874
	16	42	18	142	10	VV1642BMSSD	\$1,607	\$1,768
	16	36	18	133	8	VV1636BMSSD	\$1,522	\$1,674
	16	30	18	128	7	VV1630BMSSD	\$1,416	\$1,558

· must be supported by two storage towers  
 · white markerboard doors available, specify and add \$163 list  
 · locking door not available  
 · pulls not available

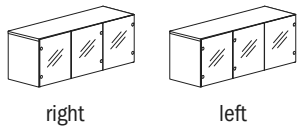
Description	D	W	H	CTN WT	CU FT	① Model	Flat Cut List		Double Cut List	
							Frameless	Aluminum Frame	Frameless	Aluminum Frame

**Bridge Mount Overhead Cabinet with Four Glass Doors**



- select Frosted Frameless, Frosted with Aluminum Frame or White Back Painted with Aluminum Frame
- must be supported by two storage towers
- locking doors not available
- pulls not available

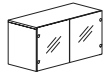
**Bridge Mount Overhead Cabinet with Three Glass Doors**



16	48	18	150	11	<b>WV1648GBMSR</b>	\$1,689	\$2,110	\$1,858	\$2,321
16	48	18	150	11	<b>WV1648GBMSL</b>	\$1,689	\$2,110	\$1,858	\$2,321
16	42	18	139	10	<b>WV1642GBMSR</b>	\$1,502	\$1,904	\$1,652	\$2,095
16	42	18	139	10	<b>WV1642GBMSL</b>	\$1,502	\$1,904	\$1,652	\$2,095

- select Frosted Frameless, Frosted with Aluminum Frame or White Back Painted with Aluminum Frame
- must be supported by two storage towers
- right door configuration - 1 door hinges left and 2 doors hinge right
- left door configuration - 1 door hinges right and 2 doors hinge left
- locking doors not available
- pulls not available

**Bridge Mount Overhead Cabinet with Two Glass Doors**



16	36	18	130	8	<b>WV1636GBMS</b>	\$1,310	\$1,602	\$1,441	\$1,762
16	30	18	125	7	<b>WV1630GBMS</b>	\$1,247	\$1,523	\$1,372	\$1,675

- select Frosted Frameless, Frosted with Aluminum Frame or White Back Painted with Aluminum Frame
- must be supported by two storage towers
- locking doors not available
- pulls not available

**To Order, Specify:**

- ① Model Number
- ② Wood Species - Cherry (CH1), Maple (MA1), Walnut (WA1) or Double Cut (see page 228)
- ③ Finish Color (see page 229)
- ④ Glass Option/Color (see page 237)
- ⑤ Other Product Options (see page 229)

When ordering Quickship products, place a "Q" in front of model number.  
Example: QVW3072DD

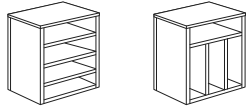




Description	D	W	H	CTN WT	CU FT	① Model	Flat Cut List Price	Double Cut List Price
-------------	---	---	---	-----------	----------	---------	------------------------	--------------------------

Storage Tower Insert Transaction Support Cabinet	10 <sup>3</sup> / <sub>4</sub>	16	24 <sup>3</sup> / <sub>4</sub>	18	6	VV2016ST	\$700	\$770
---	--------------------------------	----	--------------------------------	----	---	----------	-------	-------

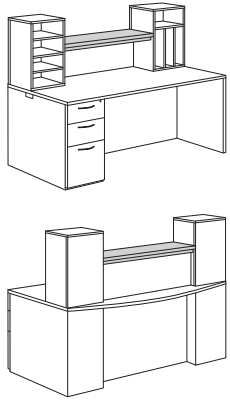
**NOW!**



- support for transaction surfaces
- paper management slots can be configured horizontally or with three vertical slots
- can be used under storage overhead cabinet
- see page 247 for application

Transaction Surface Top	14	40	3	21	5	VV1440TS	\$280	\$308
	14	34	3	17	5	VV1434TS	\$263	\$289
	14	28	3	13	5	VV1428TS	\$252	\$278

**NOW!**

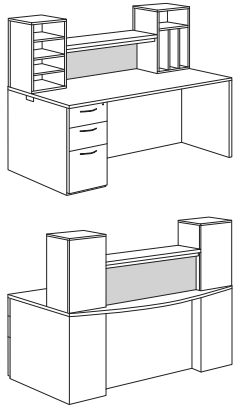


- top edge profile on user and approach sides
- long grain direction
- must be supported by two VV2016ST; see above
- VV1440TS sets on top of 72" desk or credenza top
- VV1434TS sets on top of 66" desk or credenza top
- VV1428TS sets on top of 60" desk or credenza top
- trim transaction panel available, see below

Description	D	W	H	CTN WT	CU FT	① Model	List Price
-------------	---	---	---	-----------	----------	---------	------------

Transaction Trim Panel	1/4	39 1/2	12	5	2	VS1240FTS	\$465
	1/4	33 1/2	12	5	2	VS1234FTS	\$446
	1/4	27 1/2	12	4	2	VS1228FTS	\$398

**NOW!**

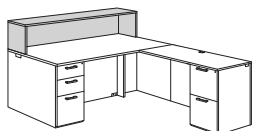


- frosted acrylic panel
- coordinates with two VV2016ST and transaction surface

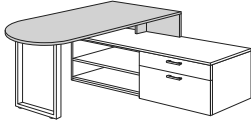

Description	D	W	H	CTN WT	CU FT	① Model	Flat Cut List Price	Double Cut List Price
-------------	---	---	---	-----------	----------	---------	------------------------	--------------------------

Transaction Counter	13	72	16	87	9	VV1372TC	\$1,008	\$1,109
	13	66	16	79	8	VV1366TC	\$963	\$1,060

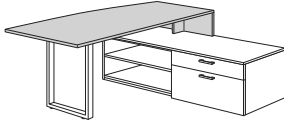
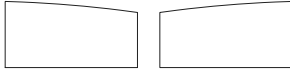
**NOW!**



- VV1372TC coordinates with 72" worksurface
- VV1366TC coordinates with 66" worksurface
- back panel grain is horizontal

Description	D	W	H	CTN WT	CU FT	① Model	Flat Cut List Price	Double Cut List Price
Bench Height Supported	36	84	9 1/2	170	22	WB3684B	\$2,451	\$2,697
Bullet Peninsula Desk	36	78	9 1/2	164	21	WB3678B	\$2,384	\$2,622
<b>NOW!</b>	36	72	9 1/2	158	19	WB3672B	\$2,005	\$2,205
	30	84	9 1/2	163	19	WB3084B	\$2,300	\$2,530
	30	78	9 1/2	158	18	WB3078B	\$2,223	\$2,446
	30	72	9 1/2	153	16	WB3072B	\$1,940	\$2,134

- must attach to bench height cabinets, see pages 372-381
- edge profile on three open sides
- one end panel grommet
- trim modesty panel, see page 371
- non-handed
- not recommended for freestanding use
- bases must be purchased separately; see page 371 for options

Description	D	W	H	CTN WT	CU FT	① Model	Flat Cut List Price	Double Cut List Price
Bench Height Supported	36	84	9 1/2	171	22	WB3684FINR	\$2,355	\$2,591
Fin Peninsula Desk	36	84	9 1/2	171	22	WB3684FINL	\$2,355	\$2,591
<b>NOW!</b>	36	78	9 1/2	165	21	WB3678FINR	\$2,285	\$2,514
	36	78	9 1/2	165	21	WB3678FINL	\$2,285	\$2,514
left shown	36	72	9 1/2	159	19	WB3672FINR	\$2,057	\$2,263
	36	72	9 1/2	159	19	WB3672FINL	\$2,057	\$2,263
left	30	84	9 1/2	164	19	WB3084FINR	\$2,220	\$2,443
right	30	84	9 1/2	164	19	WB3084FINL	\$2,220	\$2,443
	30	78	9 1/2	159	18	WB3078FINR	\$2,137	\$2,351
	30	78	9 1/2	159	18	WB3078FINL	\$2,137	\$2,351
	30	72	9 1/2	154	16	WB3072FINR	\$1,923	\$2,116
	30	72	9 1/2	154	16	WB3072FINL	\$1,923	\$2,116

- 30" deep at end panel for 36" deep top
- 24" deep at end panel for 30" deep top
- must attach to bench height cabinets, see pages 372-381
- edge profile on three open sides
- one end panel grommet
- trim modesty panel, see page 371
- not recommended for freestanding use
- bases must be purchased separately; see page 371 for options

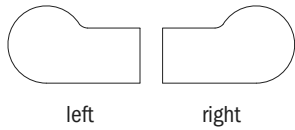
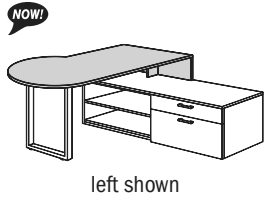
**To Order, Specify:**

- ① Model Number
- ② Wood Species - Cherry (CH1), Maple (MA1), Walnut (WA1) or Double Cut (see page 228)
- ③ Finish Color (see page 229)
- ④ Edge Profile (see page 233)
- ⑤ Grommet Color - Matte Black (MBK) or Stardust Silver (STS) (see page 234)
- ⑥ Other Product Options (see page 229)
- ⑦ Accessories (see page 407)
- ⑧ Power and Data Options (see page 407)

When ordering Quickship products, place a "Q" in front of model number.  
Example: QV3072DD

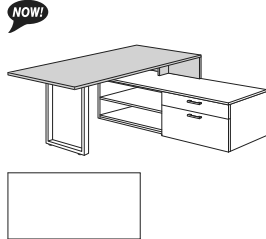


Description	D	W	H	CTN WT	CU FT	① Model	Flat Cut List Price	Double Cut List Price
Bench Height Supported P-Top Peninsula Desk	42	84	9 1/2	185	26	VVB4284RP	\$2,609	\$2,870
	42	84	9 1/2	185	26	VVB4284LP	\$2,609	\$2,870
	42	78	9 1/2	179	24	VVB4278RP	\$2,512	\$2,764
	42	78	9 1/2	179	24	VVB4278LP	\$2,512	\$2,764
	42	72	9 1/2	170	22	VVB4272RP	\$2,359	\$2,595
	42	72	9 1/2	170	22	VVB4272LP	\$2,359	\$2,595



- 42" widest point
- 30" at end panel
- must attach to bench height cabinets, see pages 372-381
- edge profile on three open sides
- one end panel grommet
- trim modesty panel, see page 371
- not recommended for freestanding use
- bases must be purchased separately; see page 371 for options

Bench Height Supported Rectangle Peninsula Desk	36	84	9 1/2	171	22	VVB3684RCT	\$1,760	\$1,937
	36	78	9 1/2	165	21	VVB3678RCT	\$1,664	\$1,831
	36	72	9 1/2	159	19	VVB3672RCT	\$1,598	\$1,758
	30	84	9 1/2	164	19	VVB3084RCT	\$1,678	\$1,846
	30	78	9 1/2	159	18	VVB3078RCT	\$1,616	\$1,778
	30	72	9 1/2	154	16	VVB3072RCT	\$1,569	\$1,727

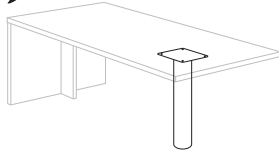


- must attach to bench height cabinets, see pages 372-381
- edge profile on three open sides
- one end panel grommet
- trim modesty panel, see page 371
- non-handed
- not recommended for freestanding use
- bases must be purchased separately; see page 371 for options

Description

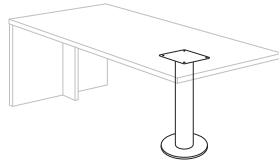
Base Options for Bench Height Supported Peninsula Desks (these bases must be ordered separately from the desks listed on pages 369-370)

**NOW!**



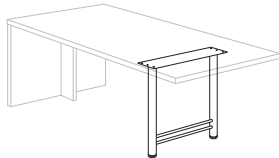
- Column Base**
- 04BB - Black Sandtex- \$321
  - 04SB - Stardust Silver - \$321

- Base:**
- 13 gauge steel
  - 4" diameter



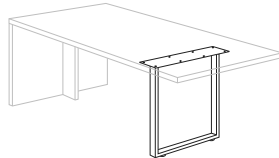
- Column Disk Base**
- 12DB - Black Sandtex- \$385
  - 12DS - Stardust Silver - \$385

- Base:**
- support disk: 11" diameter



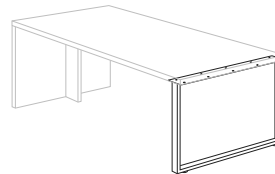
- H Base**
- use with 36" or 48" deep tops
- 24HB - Black Sandtex - \$354
  - 24HS - Stardust Silver - \$354

- use with 30" deep tops
- 18HB - Black Sandtex - \$333
  - 18HS - Stardust Silver - \$333



- U Base**
- use with 36" or 48" deep tops
- 24UB - Black Sandtex- \$354
  - 24US - Stardust Silver - \$354

- use with 30" deep tops
- 18UB - Black Sandtex- \$333
  - 18US - Stardust Silver - \$333



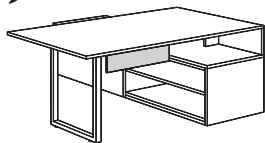
- ▲ Rectangular Base**
- use with 36" deep tops
- 36FSQB - Black Sandtex- \$473
  - 36FSQS - Stardust Silver - \$473

- use with 30" deep tops
- 30FSQB - Black Sandtex- \$457
  - 30FSQS - Stardust Silver - \$457

\*\* should not be used with fin shaped tops

Description	D	W	H	CTN WT	CU FT	① Model	List Price
Trim Modesty Panel for Bench Height Supported Peninsula Desks	1/4	40	10	5	2	VS1040FMP	\$458
	1/4	34	10	4	2	VS1034FMP	\$438
	1/4	28	10	4	1	VS1028FMP	\$388

**NOW!**



- mounts in open kneespace area
- acrylic panel - frosted
- field installed
- VS1040FMP use with 84" bullet, fin, P-top or rectangle peninsula desk for bench height
- VS1034FMP use with 78" bullet, fin, P-top or rectangle peninsula desk for bench height
- VS1028FMP use with 72" bullet, fin, P-top or rectangle peninsula desk for bench height

To Order, Specify:


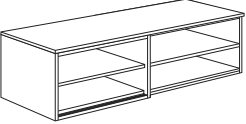
- ① Model Number
- ② Wood Species - Cherry (CH1), Maple (MA1), Walnut (WA1) or Double Cut (see page 228)
- ③ Finish Color (see page 229)
- ④ Edge Profile (see page 233)
- ⑤ Grommet Color - Matte Black (MBK) or Stardust Silver (STS) (see page 234)

- ⑥ Other Product Options (see page 229)
- ⑦ Power and Data Options (see page 407)

When ordering Quickship products, place a "Q" in front of model number.  
Example: QV3072DD

**NOW!**  
Need it.  
JSI Quickship

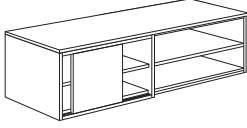
Freestanding Bench Height Configurations

Description	D	W	H	CTN WT	CU FT	① Model	Flat Cut List Price	Double Cut List Price
72" w and 60" w Bench Height Configurations  	24	72	19 1/2	284	24	<b>VVB-36BF36BF**</b> 36" Box/File - left 36" Box/File - right	\$2,337	\$2,571
	24	60	19 1/2	270	21	<b>VVB-30BF30BF**</b> 30" Box/File - left 30" Box/File - right	\$2,171	\$2,388
	24	72	19 1/2	245	24	<b>VVB-36BF36OS</b> 36" Box/File - left 36" Open Shelf - right	\$2,031	\$2,235
	24	60	19 1/2	230	21	<b>VVB-30BF30OS</b> 30" Box/File - left 30" Open Shelf - right	\$1,879	\$2,067
	24	72	19 1/2	226	24	<b>VVB-36HD36OS</b> 36" Hinged Doors - left 36" Open Shelf - right	\$1,850	\$2,035
	24	60	19 1/2	213	21	<b>VVB-30HD30OS</b> 30" Hinged Doors - left 30" Open Shelf - right	\$1,703	\$1,874
	24	72	19 1/2	274	24	<b>VVB-36OF36OF**</b> 36" Open/File - left 36" Open/File - right	\$2,327	\$2,560
	24	60	19 1/2	244	21	<b>VVB-30OF30OF**</b> 30" Open/File - left 30" Open/File - right	\$2,149	\$2,364
	24	72	19 1/2	245	24	<b>VVB-36OS36BF</b> 36" Open Shelf - left 36" Box/File - right	\$2,031	\$2,235
	24	60	19 1/2	230	21	<b>VVB-30OS30BF</b> 30" Open Shelf - left 30" Box/File - right	\$1,879	\$2,067
	24	72	19 1/2	226	24	<b>VVB-36OS36HD</b> 36" Open Shelf - left 36" Hinged Doors - right	\$1,850	\$2,035
	24	60	19 1/2	213	21	<b>VVB-30OS30HD</b> 30" Open Shelf - left 30" Hinged Doors - right	\$1,703	\$1,874
	24	72	19 1/2	206	24	<b>VVB-36OS36OS</b> 36" Open Shelf - left 36" Open Shelf - right	\$1,602	\$1,762
	24	60	19 1/2	190	21	<b>VVB-30OS30OS</b> 30" Open Shelf - left 30" Open Shelf - right	\$1,474	\$1,622

- 3/4" common top panel
- two 20 lb. counterweights required, see page 383 for counterweight\*\*
- unit can be secured to wall or floor as alternative to counterweight\*\*
- locking drawer available, specify and add \$105 list per drawer set
- locking hinged doors available, specify and add \$105 list per door set

VISION - VENEER

Freestanding Bench Height Configurations

Description	D	W	H	CTN WT	CU FT	① Model	Flat Cut List Price	Double Cut List Price
72" w and 60" w Bench Height Configurations 	24	72	19 1/2	227	24	<b>WB-360S36SD</b> 36" Open Shelf - left 36" Sliding Door - right	\$2,043	\$2,247
	24	60	19 1/2	208	21	<b>WB-300S30SD</b> 30" Open Shelf - left 30" Sliding Door - right	\$1,899	\$2,089
	24	72	19 1/2	227	24	<b>WB-36SD360S</b> 36" Sliding Door - left 36" Open Shelf - right	\$2,043	\$2,247
	24	60	19 1/2	208	21	<b>WB-30SD300S</b> 30" Sliding Door - left 30" Open Shelf - right	\$1,899	\$2,089
	24	72	19 1/2	248	24	<b>WB-36SD36SD</b> 36" Sliding Door - left 36" Sliding Door - right	\$2,557	\$2,813
	24	60	19 1/2	226	21	<b>WB-30SD30SD</b> 30" Sliding Door - left 30" Sliding Door - right	\$2,396	\$2,636

**NOW!**

- 3/4" common top panel
- locking sliding doors not available

VISION - VENEER


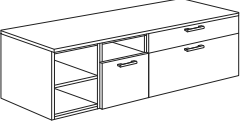
To Order, Specify:

- ① Model Number
- ② Wood Species - Cherry (CH1), Maple (MA1), Walnut (WA1) or Double Cut (see page 228)
- ③ Finish Color (see page 229)
- ④ Pull Style and Color (see page 233)
- ⑤ Other Product Options (see page 229)

When ordering Quickship products, place a "Q" in front of model number.  
Example: QV3072DD



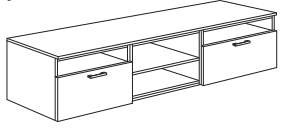
**Freestanding Bench Height Configurations**

Description	D	W	H	CTN WT	CU FT	① Model	Flat Cut List Price	Double Cut List Price
<b>72" Bench Height Configurations</b>  	24	72	19 1/2	274	24	<b>VVB-360S18BF18HR</b> 36" Open Shelf - left 18" Box/File - center 18" Hinged Door - right	\$2,471	\$2,719
	24	72	19 1/2	274	24	<b>VVB-18HL18BF360S</b> 18" Hinged Door - left 18" Box/File - center 36" Open Shelf - right	\$2,471	\$2,719
	24	72	19 1/2	304	24	<b>VVB-36BF18BF180S**</b> 36" Box/File - left 18" Box/File - center 18" Open Shelf - right	\$2,681	\$2,950
	24	72	19 1/2	304	24	<b>VVB-180S18BF36BF**</b> 18" Open Shelf - left 18" Box/File - center 36" Box/File - right	\$2,681	\$2,950
	24	72	19 1/2	297	24	<b>VVB-36BF180F180S**</b> 36" Box/File - left 18" Open/File - center 18" Open Shelf - right	\$2,656	\$2,922
	24	72	19 1/2	297	24	<b>VVB-180S180F36BF**</b> 18" Open Shelf - left 18" Open/File - center 36" Box/File - right	\$2,656	\$2,922

- 3/4" common top panel
- one 20 lb. counterweight required, see page 383 for counterweight\*\*
- unit can be secured to wall or floor as alternative to counterweight\*\*
- locking drawers available, specify and add \$105 list per drawer set
- locking hinged doors available, specify and add \$105 list per door set

VISION - VENEER

Freestanding Bench Height Configurations

Description	D	W	H	CTN WT	CU FT	① Model	Flat Cut List Price	Double Cut List Price
<b>90" Bench Height Configurations</b> 	24	90	19 1/2	285	30	<b>WB-300S300S300S</b> (3) 30" Open Shelf	\$2,184	\$2,403
	24	90	19 1/2	366	30	<b>WB-300F300F300F**</b> (3) 30" Open/File	\$3,197	\$3,517
	24	90	19 1/2	365	30	<b>WB-30BF300S30BF</b> 30" Box/File - left 30" Open Shelf - center 30" Box/File - right	\$2,936	\$3,230
	24	90	19 1/2	339	30	<b>WB-300F300S300F</b> 30" Open File - left 30" Open Shelf - center 30" Open/File - right	\$2,915	\$3,207
	24	90	19 1/2	343	30	<b>WB-300S30HD30BF</b> 30" Open Shelf - left 30" Hinged Doors - center 30" Box/File - right	\$2,760	\$3,036
	24	90	19 1/2	343	30	<b>WB-30BF30HD300S</b> 30" Box/File - left 30" Hinged Doors - center 30" Open Shelf - right	\$2,760	\$3,036
	24	90	19 1/2	351	30	<b>WB-30BF30SD300S</b> 30" Box/File - left 30" Sliding Door - center 30" Open Shelf - right	\$2,956	\$3,252
	24	90	19 1/2	351	30	<b>WB-300S30SD30BF</b> 30" Open Shelf - left 30" Sliding Door - center 30" Box/File - right	\$2,956	\$3,252

- 3/4" common top panel
- three 20 lb. counterweights required, see page 383 for counterweight\*\*
- unit can be secured to wall or floor as alternative to counterweight\*\*
- locking sliding doors not available
- locking drawer(s) available, specify and add \$105 list per drawer set
- locking hinged doors available, specify and add \$105 list per door set

To Order, Specify:

- ① Model Number
- ② Wood Species - Cherry (CH1), Maple (MA1), Walnut (WA1) or Double Cut (see page 228)
- ③ Finish Color (see page 229)
- ④ Pull Style and Color (see page 233)
- ⑤ Other Product Options (see page 229)

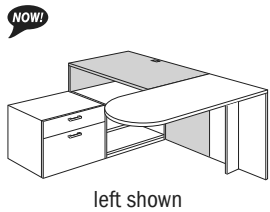
When ordering Quickship products, place a "Q" in front of model number.  
Example: QVW3072DD





**Freestanding Bench Height**

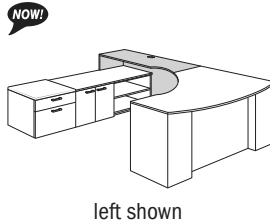
Description	D	W	H	CTN WT	CU FT	① Model	Flat Cut List Price	Double Cut List Price
Bench Height Supported Shell Return	24	72	30	149	36	VVB2472RSHR	\$1,323	\$1,456
	24	72	30	149	36	VVB2472LSHR	\$1,323	\$1,456
	24	66	30	143	33	VVB2466RSHR	\$1,232	\$1,356
	24	66	30	143	33	VVB2466LSHR	\$1,232	\$1,356



left shown

- must be attached to bench height cabinets, see pages 371-381
- top edge profile on user side
- short grain direction for 66" and 72" wide veneer worksurface
- long grain direction for 66" and 72" wide laminate worksurface
- one end and back panel grommet
- one surface grommet

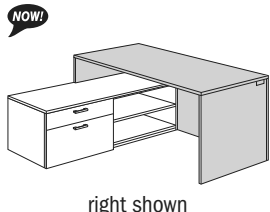
Bench Height Supported Cockpit Shell Return	24	66	30	153	36	VVB2466RCSHR	\$1,556	\$1,712
	24	66	30	153	36	VVB2466LCSHR	\$1,556	\$1,712
	24	60	30	147	33	VVB2460RCSHR	\$1,464	\$1,611
	24	60	30	147	33	VVB2460LCSHR	\$1,464	\$1,611
	24	54	30	147	33	VVB2454RCSHR	\$1,412	\$1,553
	24	54	30	147	33	VVB2454LCSHR	\$1,412	\$1,553



left shown

- must be attached to bench height cabinets, see pages 371-381
- top edge profile on user side
- short grain direction for 54", 60" and 66" wide veneer worksurface
- long grain direction for 66" wide laminate worksurface
- short grain direction for 54" and 60" wide laminate worksurface
- one end and back panel grommet
- one surface grommet

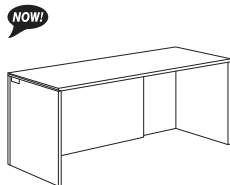
Bench Height Supported Shell Credenza	24	72	30	157	36	VVB2472SHBR	\$1,512	\$1,664
	24	72	30	157	36	VVB2472SHBL	\$1,512	\$1,664
	24	66	30	151	33	VVB2466SHBR	\$1,425	\$1,568
	24	66	30	151	33	VVB2466SHBL	\$1,425	\$1,568



right shown

- must be attached to bench height cabinets, see pages 371-381
- edge profile on user side only
- one end and back panel grommet

Shell Credenza	24	72	30	159	36	VV2472SHD	\$1,512	\$1,664
	24	66	30	153	33	VV2466SHD	\$1,425	\$1,568



- for use with bench height cabinets, see pages 371-381
- edge profile on user side only
- two end panel grommets and one back panel grommet

Freestanding Bench Height Cabinets

Description	D	W	H	CTN WT	CU FT	1 Model	Flat Cut List Price	Double Cut List Price
Box/File Bench Height Pedestal	24	36	19 1/2	142	13	WB2436BF	\$1,197	\$1,317
<b>NOW!</b>	18	36	19 1/2	126	10	WB1836BF	\$1,110	\$1,222
	24	30	19 1/2	135	11	WB2430BF	\$1,111	\$1,223
	18	30	19 1/2	121	8	WB1830BF	\$1,028	\$1,131



- freestanding unit with top
- one 20 lb. counterweight required for 24" deep units, two 20 lb. counterweights required for 18" deep units, see page 383 for counterweight
- unit can be secured to wall or floor as alternative to counterweight
- locking drawers available, specify and add \$105 list

Box/File Bench Height Pedestal	24	18	19 1/2	89	7	WB2418BF	\$914	\$1,005
<b>NOW!</b>	18	18	19 1/2	79	5	WB1818BF	\$860	\$947



- freestanding unit with top
- one 10 lb. counterweight required for 24" deep unit, one 20 lb. counterweight required for 18" deep unit, see page 383 for counterweight
- unit can be secured to wall or floor as alternative to counterweight
- locking drawers available, specify and add \$105 list

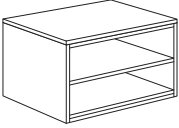
To Order, Specify:

- 1 Model Number
- 2 Wood Species - Cherry (CH1), Maple (MA1), Walnut (WA1) or Double Cut (see page 228)
- 3 Finish Color (see page 229)
- 4 Grommet Color - Matte Black (MBK) or Stardust Silver (STS) (see page 234)
- 5 Pull Style and Color (see page 233)
- 6 Other Product Options (see page 229)

When ordering Quickship products, place a "Q" in front of model number.  
Example: QV3072DD




**Freestanding Bench Height Cabinets**

Description	D	W	H	CTN WT	CU FT	① Model	Flat Cut List Price	Double Cut List Price
Open Shelf Bench Height Pedestal	24	36	19 1/2	103	13	VVB24360S	\$826	\$909
<b>NOW!</b>	18	36	19 1/2	87	10	VVB18360S	\$734	\$808
	24	30	19 1/2	95	11	VVB24300S	\$763	\$839
	18	30	19 1/2	81	8	VVB18300S	\$683	\$751

- freestanding unit with top
- adjustable shelf

Open Shelf Bench Height Pedestal	24	18	19 1/2	73	7	VVB24180S	\$636	\$700
<b>NOW!</b>	18	18	19 1/2	63	5	VVB18180S	\$580	\$639

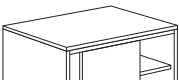
- freestanding unit with top
- adjustable shelf

Open Shelf/File Drawer Bench Height Pedestal	24	36	19 1/2	137	13	VVB24360F	\$1,192	\$1,312
<b>NOW!</b>	18	36	19 1/2	121	10	VVB18360F	\$1,090	\$1,200
	24	30	19 1/2	122	11	VVB24300F	\$1,102	\$1,212
	18	30	19 1/2	108	8	VVB18300F	\$1,006	\$1,107

- freestanding unit with top
- one 20 lb. counterweight required for 24" deep unit, two 20 lb. counterweights required for 18" deep unit, see page 383 for counterweights
- unit can be secured to wall or floor as alternative to counterweight
- locking drawer available, specify and add \$105 list

Open Shelf/File Drawer Bench Height Pedestal	24	18	19 1/2	82	7	VVB24180F	\$889	\$978
<b>NOW!</b>	18	18	19 1/2	72	5	VVB18180F	\$826	\$909

- freestanding unit with top
- one 10 lb. counterweight required for 24" deep unit, one 20 lb. counterweight required for 18" deep unit, see page 383 for counterweights ▲
- unit can be secured to wall or floor as alternative to counterweight
- locking drawer available, specify and add \$105 list

Sliding Door Bench Height Pedestal	24	36	19 1/2	137	13	VVB2436SD	\$1,208	\$1,329
<b>NOW!</b>	18	36	19 1/2	121	10	VVB1836SD	\$1,102	\$1,212
	24	30	19 1/2	122	11	VVB2430SD	\$1,133	\$1,247
	18	30	19 1/2	108	8	VVB1830SD	\$1,040	\$1,144

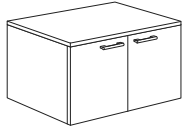
- freestanding unit with top
- adjustable shelf
- locking door not available

VISION - VENEER

Freestanding Bench Height Cabinets

Description	D	W	H	CTN WT	CU FT	① Model	Flat Cut List Price	Double Cut List Price
Hinged Doors Bench Height Pedestal	24	36	19 1/2	123	13	WB2436HD	\$1,016	\$1,118
	18	36	19 1/2	107	10	WB1836HD	\$943	\$1,038
	24	30	19 1/2	118	11	WB2430HD	\$936	\$1,031
	18	30	19 1/2	104	8	WB1830HD	\$860	\$947

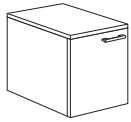
NOW!



- freestanding unit with top
- locking doors available, specify and add \$105 list

Hinged Door Bench Height Pedestal	24	18	19 1/2	82	7	WB2418HR	\$781	\$859
	24	18	19 1/2	82	7	WB2418HL	\$781	\$859
	18	18	19 1/2	72	5	WB1818HR	\$720	\$792
	18	18	19 1/2	72	5	WB1818HL	\$720	\$792

NOW!



left shown

- freestanding unit with top
- locking door available, specify and add \$105 list

To Order, Specify:

- ① Model Number
- ② Wood Species - Cherry (CH1), Maple (MA1), Walnut (WA1) or Double Cut (see page 228)
- ③ Finish Color (see page 229)
- ④ Pull Style and Color (see page 233)
- ⑤ Other Product Options (see page 229)

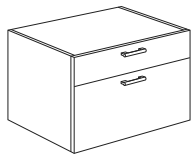
When ordering Quickship products, place a "Q" in front of model number.  
Example: QV3072DD

**NOW!**  
Need it.  
JSI Quickship

### Modular Bench Height Cabinets

These units require a top. Units are meant to sit side by side with a common top. See page 382 for bench height tops.

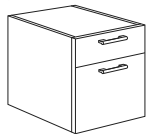
Description	D	W	H	CTN WT	CU FT	① Model	Flat Cut List Price	Double Cut List Price
Box/File Bench Height Modular Pedestal	24	36	18 3/4	125	12	VVB2436MBF	\$977	\$1,075
	24	30	18 3/4	121	10	VVB2430MBF	\$913	\$1,004
	18	36	18 3/4	112	10	VVB1836MBF	\$917	\$1,010
	18	30	18 3/4	109	8	VVB1830MBF	\$851	\$936



NOW!

- use with other modular bench height cabinets and tops
- if more than two thirds of the area under the common top is occupied by cabinets with a file drawer a 20 lb. counterweight will be required for 24" deep units while two 20 lb. counterweights will be required for 18" deep units, see page 383 for counterweight
- unit can be secured to wall or floor as alternative to counterweight
- locking drawers available, specify and add \$105 list

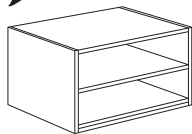
Box/File Bench Height Modular Pedestal	24	18	18 3/4	81	7	VVB2418MBF	\$754	\$830
	18	18	18 3/4	72	5	VVB1818MBF	\$717	\$789



NOW!

- use with other modular bench height cabinets and tops
- if more than two thirds of the area under the common top is occupied by cabinets with a file drawer a 10 lb. counterweight will be required for 24" deep units while one 20 lb. counterweight will be required for 18" deep units, see page 383 for counterweight ▲
- unit can be secured to wall or floor as alternative to counterweight
- locking drawers available, specify and add \$105 list

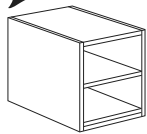
Open Shelf Bench Height Modular Pedestal	24	36	18 3/4	86	12	VVB2436MOS	\$691	\$761
	24	30	18 3/4	81	10	VVB2430MOS	\$642	\$707
	18	36	18 3/4	73	10	VVB1836MOS	\$620	\$682
	18	30	18 3/4	69	8	VVB1830MOS	\$580	\$639



NOW!

- use with other modular bench height cabinets and tops
- adjustable shelf

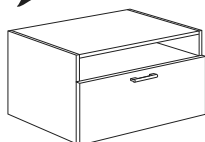
Open Shelf Bench Height Modular Pedestal	24	18	18 3/4	65	7	VVB2418MOS	\$541	\$596
	18	18	18 3/4	56	5	VVB1818MOS	\$497	\$548



NOW!

- use with other modular bench height cabinets and tops
- adjustable shelf

Open Shelf/File Drawer Bench Height Modular Pedestal	24	36	18 3/4	120	12	VVB2436MOF	\$971	\$1,068
	24	30	18 3/4	108	10	VVB2430MOF	\$903	\$994
	18	36	18 3/4	107	10	VVB1836MOF	\$897	\$987
	18	30	18 3/4	96	8	VVB1830MOF	\$832	\$916



NOW!

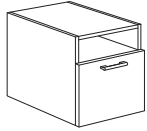
- use with other modular bench height cabinets and tops
- if more than two thirds of the area under the common top is occupied by cabinets with a file drawer a 20 lb. counterweight will be required for 24" deep units while two 20 lb. counterweights will be required for 18" deep units, see page 383 for counterweight ▲
- unit can be secured to wall or floor as alternative to counterweight
- locking drawer available, specify and add \$105 list

**Modular Bench Height Cabinets**

These units require a top. Units are meant to sit side by side with a common top. See page 382 for bench height tops.

Description	D	W	H	CTN WT	CU FT	① Model	Flat Cut List Price	Double Cut List Price
Open Shelf/File Drawer Bench Height Modular Pedestal	24	18	18 3/4	74	7	VVB2418MOF	\$732	\$806
	18	18	18 3/4	65	5	VVB1818MOF	\$684	\$753

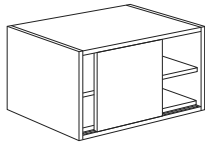
**NOW!**



- use with other modular bench height cabinets and tops
- if more than two thirds of the area under the common top is occupied by cabinets with a file drawer a 10 lb. counterweight will be required for 24" deep units while one 20 lb. counterweight will be required for 18" deep units, see page 383 for counterweight
- unit can be secured to wall or floor as alternative to counterweight
- locking drawer available, specify and add \$105 list

Sliding Door Bench Height Modular Pedestal	24	36	18 3/4	107	12	VVB2436MSD	\$1,062	\$1,169
	24	30	18 3/4	99	10	VVB2430MSD	\$1,001	\$1,102

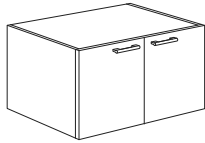
**NOW!**



- |  |    |    |        |    |    |            |       |         |
|--|----|----|--------|----|----|------------|-------|---------|
|  | 18 | 36 | 18 3/4 | 94 | 10 | VVB1836MSD | \$979 | \$1,078 |
|  | 18 | 30 | 18 3/4 | 87 | 8  | VVB1830MSD | \$929 | \$1,022 |
- use with other modular bench height cabinets and tops
  - adjustable shelf
  - locking door not available

Hinged Door Bench Height Modular Pedestal	24	36	18 3/4	106	12	VVB2436MHD	\$870	\$957
	24	30	18 3/4	104	10	VVB2430MHD	\$806	\$887

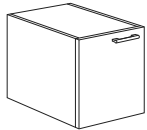
**NOW!**



- |  |    |    |        |    |    |            |       |       |
|--|----|----|--------|----|----|------------|-------|-------|
|  | 18 | 36 | 18 3/4 | 93 | 10 | VVB1836MHD | \$819 | \$901 |
|  | 18 | 30 | 18 3/4 | 92 | 8  | VVB1830MHD | \$749 | \$825 |
- use with other modular bench height cabinets and tops
  - locking doors available, specify and add \$105 list
  - hinge determines left or right for 18" wide units

Hinged Door Bench Height Modular Pedestal	24	18	18 3/4	74	7	VVB2418MHR	\$680	\$748
	24	18	18 3/4	74	7	VVB2418MHL	\$680	\$748

**NOW!**



left shown

- |  |    |    |        |    |   |            |       |       |
|--|----|----|--------|----|---|------------|-------|-------|
|  | 18 | 18 | 18 3/4 | 65 | 5 | VVB1818MHR | \$630 | \$693 |
|  | 18 | 18 | 18 3/4 | 65 | 5 | VVB1818MHL | \$630 | \$693 |
- use with other modular bench height cabinets and tops
  - locking door available, specify and add \$105 list
  - hinge determines left or right for 18" wide units


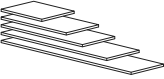
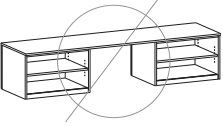
**To Order, Specify:**

- ① Model Number
- ② Wood Species - Cherry (CH1), Maple (MA1), Walnut (WA1) or Double Cut (see page 228)
- ③ Finish Color (see page 229)
- ④ Pull Style and Color (see page 233)
- ⑤ Other Product Options (see page 229)

When ordering Quickship products, place a "Q" in front of model number.  
Example: QV3072DD

**NOW!**  
Need it.  
JSI Quickship

**Modular**

Description	D	W	H	CTN WT	CU FT	① Model	Flat Cut List Price	Double Cut List Price
Bench Height Modular Tops	24	108	3/4	63	5	VVB24108MT	\$509	\$560
 	24	102	3/4	58	5	VVB24102MT	\$492	\$541
	24	96	3/4	55	4	VVB2496MT	\$472	\$519
	24	90	3/4	53	4	VVB2490MT	\$454	\$500
	24	84	3/4	47	4	VVB2484MT	\$436	\$480
	24	78	3/4	44	4	VVB2478MT	\$418	\$460
	24	72	3/4	42	4	VVB2472MT	\$402	\$443
	24	66	3/4	39	3	VVB2466MT	\$353	\$389
	24	60	3/4	35	3	VVB2460MT	\$334	\$368
	24	54	3/4	31	3	VVB2454MT	\$319	\$351
	24	48	3/4	28	3	VVB2448MT	\$302	\$332
	24	36	3/4	21	2	VVB2436MT	\$268	\$296
	24	30	3/4	17	2	VVB2430MT	\$245	\$270
	24	18	3/4	10	1	VVB2418MT	\$214	\$236
	18	108	3/4	54	4	VVB18108MT	\$432	\$476
	18	102	3/4	50	4	VVB18102MT	\$419	\$461
	18	96	3/4	49	4	VVB1896MT	\$405	\$446
	18	90	3/4	46	3	VVB1890MT	\$390	\$430
	18	84	3/4	41	4	VVB1884MT	\$375	\$413
	18	78	3/4	39	3	VVB1878MT	\$363	\$399
	18	72	3/4	36	3	VVB1872MT	\$349	\$385
	18	66	3/4	33	3	VVB1866MT	\$307	\$339
	18	60	3/4	30	2	VVB1860MT	\$294	\$324
	18	54	3/4	27	2	VVB1854MT	\$300	\$330
	18	48	3/4	24	2	VVB1848MT	\$268	\$296
	18	36	3/4	18	2	VVB1836MT	\$240	\$264
	18	30	3/4	15	2	VVB1830MT	\$227	\$250
	18	18	3/4	9	1	VVB1818MT	\$198	\$218

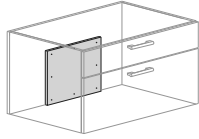
- flat edge on all four sides
- long grain direction
- modular bench height tops NOT intended for unsupported space

VISION - VENEER

Modular

Description	D	W	H	CTN WT	CU FT	① Model	List Price
Counterweights for Bench Height Units	3/4	12	11 1/4	21	1	VS20LB	\$184
	3/4	12	6	11	1	VS10LB	\$93

**NOW!**



- counterweight for modular bench height cabinets
- attaches to inside back panel of cabinet
- field installed
- hardware included

VISION - VENEER


**To Order, Specify:**


- ① Model Number
- ② Wood Species - Cherry (CH1), Maple (MA1), Walnut (WA1) or Double Cut (see page 228)
- ③ Finish Color (see page 229)


When ordering Quickship products, place a "Q" in front of model number.  
Example: QV3072DD


**NOW!**  
*Need it.*  
JSI Quickship



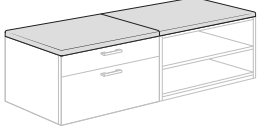
Description	D	W	H	CTN WT	CU FT	① Model	List Price Per Grade
<b>24" d Bench Height Seat Cushions</b>  <ul style="list-style-type: none"> <li>· 1 1/2" thick</li> <li>· com ydg: 1 1/4</li> </ul>	24	36	1 1/2	14	3	<b>VS2436CUSH</b>	<b>COM \$238</b> A \$250 B \$275 COL/C \$318 D \$373 E \$428 F \$513 G \$605 H \$703 I \$855 J \$1,039 L1 \$672 L2 \$782

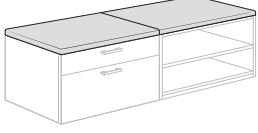
<b>24" d Bench Height Seat Cushions</b>  <ul style="list-style-type: none"> <li>· 1 1/2" thick</li> <li>· com ydg: 1 1/4</li> </ul>	24	30	1 1/2	12	2	<b>VS2430CUSH</b>	<b>COM \$227</b> A \$240 B \$264 COL/C \$307 D \$363 E \$417 F \$502 G \$595 H \$692 I \$845 J \$1,028 L1 \$662 L2 \$771
--	----	----	-------	----	---	-------------------	--

<b>24" d Bench Height Seat Cushions</b>  <ul style="list-style-type: none"> <li>· 1 1/2" thick</li> <li>· com ydg: 3/4</li> </ul>	24	18	1 1/2	7	2	<b>VS2418CUSH</b>	<b>COM \$201</b> A \$209 B \$223 COL/C \$249 D \$282 E \$315 F \$367 G \$422 H \$480 I \$572 J \$682 L1 \$461 L2 \$528
--	----	----	-------	---	---	-------------------	--

<b>18" d Bench Height Seat Cushions</b>  <ul style="list-style-type: none"> <li>· 1 1/2" thick</li> <li>· com ydg: 1 1/4</li> </ul>	18	36	1 1/2	13	2	<b>VS1836CUSH</b>	<b>COM \$222</b> A \$235 B \$259 COL/C \$302 D \$357 E \$412 F \$497 G \$590 H \$687 I \$839 J \$1,023 L1 \$657 L2 \$766
--	----	----	-------	----	---	-------------------	--

VISION - VENEER

Description	D	W	H	CTN WT	CU FT	① Model	List Price Per Grade
<b>18" d Bench Height Seat Cushions</b>  <p><b>NOW!</b></p> <ul style="list-style-type: none"> <li>• 1 1/2" thick</li> <li>• com ydg: 1 1/4</li> </ul>	18	30	1 1/2	11	2	<b>VS1830CUSH</b>	<b>COM</b> \$212 <b>A</b> \$224 <b>B</b> \$248 <b>COL/C</b> \$291 <b>D</b> \$347 <b>E</b> \$402 <b>F</b> \$487 <b>G</b> \$579 <b>H</b> \$677 <b>I</b> \$829 <b>J</b> \$1,013 <b>L1</b> \$646 <b>L2</b> \$755

<b>18" d Bench Height Seat Cushions</b>  <p><b>NOW!</b></p> <ul style="list-style-type: none"> <li>• 1 1/2" thick</li> <li>• com ydg: 3/4</li> </ul>	18	18	1 1/2	6	1	<b>VS1818CUSH</b>	<b>COM</b> \$193 <b>A</b> \$201 <b>B</b> \$215 <b>COL/C</b> \$241 <b>D</b> \$273 <b>E</b> \$307 <b>F</b> \$359 <b>G</b> \$413 <b>H</b> \$472 <b>I</b> \$563 <b>J</b> \$674 <b>L1</b> \$453 <b>L2</b> \$519
--	----	----	-------	---	---	-------------------	--

VISION - VENEER

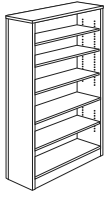
**To Order, Specify:**

- ① Model Number
- ② Fabric Selection: vendor, pattern, color

When ordering Quickship products, place a "Q" in front of model number.  
 Example: QVW3072DD

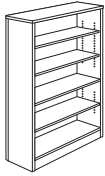


Description	D	W	H	CTN WT	CU FT	① Model	Flat Cut List Price	Double Cut List Price
Bookcase	16	36	84	181	35	VV3684BC	\$1,949	\$2,145
<b>NOW!</b>	16	30	84	170	29	VV3084BC	\$1,937	\$2,131



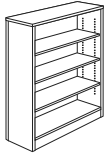
- four adjustable shelves
- one fixed shelf
- no profile edge

Bookcase	16	36	72	155	30	VV3672BC	\$1,670	\$1,837
<b>NOW!</b>	16	30	72	145	25	VV3072BC	\$1,661	\$1,827



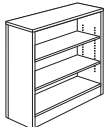
- three adjustable shelves
- one fixed shelf
- no profile edge

Bookcase	16	36	55 1/8	115	23	VV3654BC	\$1,423	\$1,566
<b>NOW!</b>	16	30	55 1/8	108	20	VV3054BC	\$1,245	\$1,370



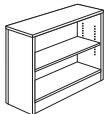
- three adjustable shelves
- no profile edge

Bookcase	16	36	42	108	18	VV3642BC	\$1,329	\$1,462
<b>NOW!</b>	16	30	42	98	15	VV3042BC	\$1,138	\$1,252



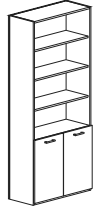
- two adjustable shelves
- no profile edge

Bookcase	16	36	30	108	13	VV3630BC	\$998	\$1,098
<b>NOW!</b>	16	30	30	98	11	VV3030BC	\$910	\$1,001



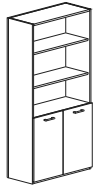
- one adjustable shelf
- no profile edge

Description	D	W	H	CTN WT	CU FT	① Model	Flat Cut List Price	Double Cut List Price
<b>Bookcase with Bottom Doors</b>	16	36	84	196	35	<b>VW3684BCD</b>	<b>\$2,197</b>	<b>\$2,418</b>
<b>NOW!</b>	16	30	84	182	29	<b>VW3084BCD</b>	<b>\$2,186</b>	<b>\$2,405</b>



- four adjustable shelves
- one fixed shelf
- no profile edge
- locking doors available, specify and add \$105 list

<b>Bookcase with Bottom Doors</b>	16	36	72	170	30	<b>VW3672BCD</b>	<b>\$1,919</b>	<b>\$2,111</b>
<b>NOW!</b>	16	30	72	157	25	<b>VW3072BCD</b>	<b>\$1,908</b>	<b>\$2,099</b>



- three adjustable shelves
- one fixed shelf
- no profile edge
- locking doors available, specify and add \$105 list

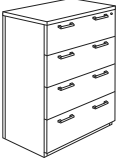
VISION - VENEER

**To Order, Specify:**


- ① Model Number
- ② Wood Species - Cherry (CH1), Maple (MA1), Walnut (WA1) or Double Cut (see page 228)
- ③ Finish Color (see page 229)
- ④ Pull Style and Color (see page 233)
- ⑤ Other Product Options (see page 229)

When ordering Quickship products, place a "Q" in front of model number.  
Example: QVW3072DD




Description	D	W	H	CTN WT	CU FT	① Model	Flat Cut List Price	Double Cut List Price
Lateral File 	24	36	56 <sup>11</sup> / <sub>16</sub>	287	34	VV2436-57LF	\$2,519	\$2,771
	24	30	56 <sup>11</sup> / <sub>16</sub>	270	29	VV2430-57LF	\$2,386	\$2,625
	20	36	56 <sup>11</sup> / <sub>16</sub>	266	29	VV2036-57LF	\$2,420	\$2,662
	20	30	56 <sup>11</sup> / <sub>16</sub>	251	24	VV2030-57LF	\$2,291	\$2,520

- top edge profile on user side
- four drawers
- anti-tip interlock mechanism
- pedestal locking

Lateral File 	24	36	42 <sup>3</sup> / <sub>4</sub>	232	26	VV2436-42LF	\$2,274	\$2,502
	24	30	42 <sup>3</sup> / <sub>4</sub>	218	22	VV2430-42LF	\$2,051	\$2,257
	20	36	42 <sup>3</sup> / <sub>4</sub>	216	22	VV2036-42LF	\$2,182	\$2,401
	20	30	42 <sup>3</sup> / <sub>4</sub>	201	19	VV2030-42LF	\$1,970	\$2,168

- top edge profile on user side
- three drawers
- anti-tip interlock mechanism
- pedestal locking

Lateral File 	24	36	30	192	19	VV2436-30LF	\$1,756	\$1,932
	24	30	30	179	16	VV2430-30LF	\$1,493	\$1,643
	20	36	30	174	16	VV2036-30LF	\$1,687	\$1,856
	20	30	30	165	14	VV2030-30LF	\$1,433	\$1,577

- top edge profile on user side
- two drawers
- anti-tip interlock mechanism
- pedestal locking

VISION - VENEER

Description	D	W	H	CTN WT	CU FT	① Model	Flat Cut List Price	Double Cut List Price
Box/Box/File Mobile Pedestal	20	16	28	97	8	VV1620MP	\$1,355	\$1,490

**NOW!**



- box/box/file only
- letter width pedestal
- pedestal front locking
- no additional top needed

Description	D	W	H	CTN WT	CU FT	① Model	List Price Per Grade	
							Flat Cut	Double Cut
Mobile Lateral File with Cushion Top	20	18	21	85	8	VV1820PT	COM \$1,435	\$1,579
							A \$1,445	\$1,589
							B \$1,464	\$1,608
							COL/C \$1,499	\$1,643
							D \$1,543	\$1,687
							E \$1,587	\$1,731
							F \$1,655	\$1,799
							G \$1,729	\$1,873
							H \$1,806	\$1,950
							I \$1,929	\$2,073
							J \$2,075	\$2,219
							L1 \$1,782	\$1,926
							L2 \$1,871	\$2,014

**NOW!**



- soft close hinged top
- legal filing from top
- com ydg: 1

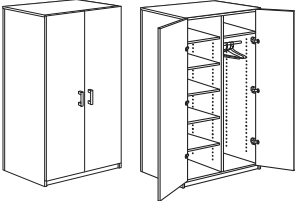
VISION - VENEER

**To Order, Specify:**

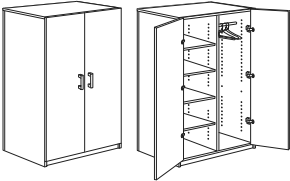
- ① Model Number
- ② Wood Species - Cherry (CH1), Maple (MA1), Walnut (WA1) or Double Cut (see page 228)
- ③ Finish Color (see page 229)
- ④ Edge Profile (see page 233)
- ⑤ Pull Style and Color (see page 233)
- ⑥ Fabric Selection: vendor, pattern, color
- ⑦ Other Product Options (see page 229)

When ordering Quickship products, place a "Q" in front of model number.  
Example: QVV3072DD

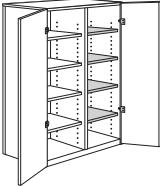


Description	D	W	H	CTN WT	CU FT	① Model	Flat Cut List Price	Double Cut List Price
<b>84" h Wardrobe</b> 	24	36	84	264	50	VV2436-84W	\$3,309	\$3,641
	24	30	84	248	42	VV2430-84W	\$2,995	\$3,295
	20	36	84	230	42	VV2036-84W	\$3,143	\$3,458
	20	30	84	216	36	VV2030-84W	\$2,845	\$3,129

- chrome hanging bar on right
- one fixed shelf second from bottom on left
- three adjustable shelves
- locking doors available, specify and add \$210 list

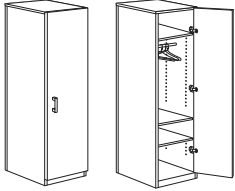
<b>72" h Wardrobe</b> 	24	36	72	226	43	VV2436-72W	\$2,997	\$3,297
	24	30	72	212	36	VV2430-72W	\$2,671	\$2,938
	20	36	72	197	36	VV2036-72W	\$2,847	\$3,133
	20	30	72	185	31	VV2030-72W	\$2,537	\$2,791

- chrome hanging bar on right
- one fixed shelf second from bottom on left
- three adjustable shelves
- locking doors available, specify and add \$210 list

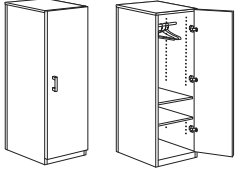
<b>Hanging Bar to Shelves Conversion Kit</b> 			$\frac{3}{4}$	18	2	VV1824SK	\$634	\$698
			$\frac{3}{4}$	15	2	VV1524SK	\$623	\$686
			$\frac{3}{4}$	16	2	VV1820SK	\$602	\$663
			$\frac{3}{4}$	14	2	VV1520SK	\$593	\$653

- four shelves
- VV1824SK - for VV2436-84W and VV2436-72W
- VV1524SK - for VV2430-84W and VV2430-72W
- VV1820SK - for VV2036-84W and VV2036-72W
- VV1520SK - for VV2030-84W and VV2030-72W

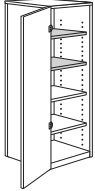
VISION - VENEER

Description	D	W	H	CTN WT	CU FT	① Model	Flat Cut List Price	Double Cut List Price
<b>84" h Wardrobe</b>  right shown	24	18	84	181	26	VV2418-84WR	\$2,655	\$2,921
	24	18	84	181	26	VV2418-84WL	\$2,655	\$2,921
	20	18	84	158	22	VV2018-84WR	\$2,523	\$2,776
	20	18	84	158	22	VV2018-84WL	\$2,523	\$2,776

- chrome hanging bar at top
- one fixed shelf 29" from cabinet floor
- one adjustable shelf
- locking doors available, specify and add \$105 list

<b>72" h Wardrobe</b>  right shown	24	18	72	155	23	VV2418-72WR	\$2,343	\$2,578
	24	18	72	155	23	VV2418-72WL	\$2,343	\$2,578
	20	18	72	135	19	VV2018-72WR	\$2,161	\$2,378
	20	18	72	135	19	VV2018-72WL	\$2,161	\$2,378

- chrome hanging bar at top
- one fixed shelf 29" from cabinet floor
- one adjustable shelf
- locking doors available, specify and add \$105 list

<b>Hanging Bar to Shelves Conversion Kit</b> 			<sup>3</sup> / <sub>4</sub>	16	2	VV1624SK	\$501	\$552
			<sup>3</sup> / <sub>4</sub>	14	2	VV1620SK	\$477	\$525

- two shelves
- VV1624SK - for VV2418-84WR/WL and VV2418-72WR/WL
- VV1620SK - for VV2018-84WR/WL and VV2018-72WR/WL

**To Order, Specify:**

- ① Model Number
- ② Wood Species - Cherry (CH1), Maple (MA1), Walnut (WA1) or Double Cut (see page 228)
- ③ Finish Color (see page 229)
- ④ Pull Style and Color (see page 233)
- ⑤ Other Product Options (see page 229)

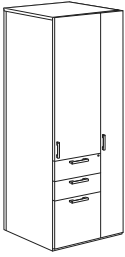
When ordering Quickship products, place a "Q" in front of model number.  
Example: QVV3072DD





Description	D	W	H	CTN WT	CU FT	① Model	Flat Cut List Price	Double Cut List Price
84" h Box/Box/File Storage Wardrobe	24	30	84	311	42	VV2430-84WR	\$4,019	\$4,421
	24	30	84	311	42	VV2430-84WL	\$4,019	\$4,421
	20	30	84	271	36	VV2030-84WR	\$3,818	\$4,200
	20	30	84	271	36	VV2030-84WL	\$3,818	\$4,200

**NOW!**



right shown

- chrome hanging bar
- three adjustable shelves
- locking doors available, specify and add \$210 list
- box/box/file pedestal
- pedestal front locking

72" h Box/Box/File Storage Wardrobe	24	30	72	271	36	VV2430-72WR	\$3,776	\$4,154
	24	30	72	271	36	VV2430-72WL	\$3,776	\$4,154
	20	30	72	236	31	VV2030-72WR	\$3,588	\$3,947
	20	30	72	236	31	VV2030-72WL	\$3,588	\$3,947

**NOW!**



right shown

- chrome hanging bar
- two adjustable shelves
- locking doors available, specify and add \$210 list
- box/box/file pedestal
- pedestal front locking

57" h Box/Box/File Storage Wardrobe	24	30	56 <sup>11</sup> / <sub>16</sub>	205	29	VV2430-57WR	\$3,341	\$3,675
	24	30	56 <sup>11</sup> / <sub>16</sub>	205	29	VV2430-57WL	\$3,341	\$3,675
	20	30	56 <sup>11</sup> / <sub>16</sub>	179	24	VV2030-57WR	\$3,175	\$3,493
	20	30	56 <sup>11</sup> / <sub>16</sub>	179	24	VV2030-57WL	\$3,175	\$3,493

**NOW!**

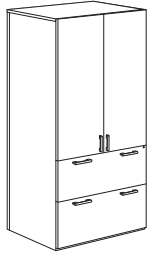


right shown

- chrome hanging bar
- two adjustable shelves
- locking doors available, specify and add \$210 list
- box/box/file pedestal
- pedestal front locking

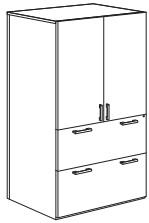
VISION - VENEER

Description	D	W	H	CTN WT	CU FT	① Model	Flat Cut List Price	Double Cut List Price
84" h File/File Lateral Storage Cabinet <b>NOW!</b>	24	36	84	330	50	VW2436-84FFT	\$4,123	\$4,535
	24	30	84	318	42	VW2430-84FFT	\$3,847	\$4,232
	20	36	84	288	42	VW2036-84FFT	\$3,917	\$4,309
	20	30	84	277	36	VW2030-84FFT	\$3,656	\$4,022



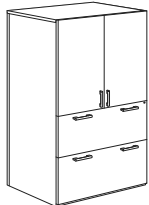
- three adjustable shelves
- locking doors available, specify and add \$105 list
- file/file lateral
- pedestal locking

72" h File/File Lateral Storage Cabinet <b>NOW!</b>	24	36	72	281	43	VW2436-72FFT	\$3,934	\$4,328
	24	30	72	266	36	VW2430-72FFT	\$3,759	\$4,135
	20	36	72	245	36	VW2036-72FFT	\$3,737	\$4,111
	20	30	72	232	31	VW2030-72FFT	\$3,573	\$3,931



- two adjustable shelves
- locking doors available, specify and add \$105 list
- file/file lateral
- pedestal locking

57" h File/File Lateral Storage Cabinet <b>NOW!</b>	24	36	56 11/16	216	34	VW2436-57FFT	\$3,350	\$3,685
	24	30	56 11/16	201	29	VW2430-57FFT	\$3,097	\$3,407
	20	36	56 11/16	188	29	VW2036-57FFT	\$3,184	\$3,503
	20	30	56 11/16	175	24	VW2030-57FFT	\$2,943	\$3,238



- two adjustable shelves
- locking doors available, specify and add \$105 list
- file/file lateral
- pedestal locking

**To Order, Specify:**

- ① Model Number
- ② Wood Species - Cherry (CH1), Maple (MA1), Walnut (WA1) or Double Cut (see page 228)
- ③ Finish Color (see page 229)
- ④ Pull Style and Color (see page 233)
- ⑤ Other Product Options (see page 229)

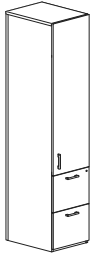
When ordering Quickship products, place a "Q" in front of model number.  
Example: QVW3072DD

**NOW!**  
Need it.  
JSI Quickship

VISION - VENEER

Description	D	W	H	CTN WT	CU FT	① Model	Flat Cut List Price	Double Cut List Price
84" h File/File Storage Cabinet	24	18	84	205	26	VV2418-84FFTR	\$3,161	\$3,477
	24	18	84	205	26	VV2418-84FFTL	\$3,161	\$3,477
	20	18	84	179	22	VV2018-84FFTR	\$3,003	\$3,304
	20	18	84	179	22	VV2018-84FFTL	\$3,003	\$3,304

**NOW!**



right shown

- three adjustable shelves
- locking doors available, specify and add \$105 list
- file/file pedestal
- pedestal front locking

72" h File/File Storage Cabinet	24	18	72	177	23	VV2418-72FFTR	\$2,925	\$3,218
	24	18	72	177	23	VV2418-72FFTL	\$2,925	\$3,218
	20	18	72	154	19	VV2018-72FFTR	\$2,779	\$3,057
	20	18	72	154	19	VV2018-72FFTL	\$2,779	\$3,057

**NOW!**



right shown

- two adjustable shelves
- locking doors available, specify and add \$105 list
- file/file pedestal
- pedestal front locking

57" h File/File Storage Cabinet	24	18	56 <sup>11</sup> / <sub>16</sub>	130	18	VV2418-57FFTR	\$2,540	\$2,795
	24	18	56 <sup>11</sup> / <sub>16</sub>	130	18	VV2418-57FFTL	\$2,540	\$2,795
	20	18	56 <sup>11</sup> / <sub>16</sub>	114	15	VV2018-57FFTR	\$2,413	\$2,655
	20	18	56 <sup>11</sup> / <sub>16</sub>	114	15	VV2018-57FFTL	\$2,413	\$2,655

**NOW!**

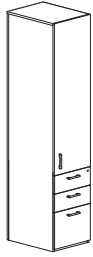


right shown

- two adjustable shelves
- locking doors available, specify and add \$105 list
- file/file pedestal
- pedestal front locking

Description	D	W	H	CTN WT	CU FT	① Model	Flat Cut List Price	Double Cut List Price
84" h Box/Box/File Storage Cabinet	24	18	84	205	26	WV2418-84BBFTR	\$3,170	\$3,488
	24	18	84	205	26	WV2418-84BBFTL	\$3,170	\$3,488
	20	18	84	179	22	WV2018-84BBFTR	\$3,013	\$3,314
	20	18	84	179	22	WV2018-84BBFTL	\$3,013	\$3,314

**NOW!**



right shown

- three adjustable shelves
- locking door available, specify and add \$105 list
- box/box/file pedestal
- pedestal front locking

72" h Box/Box/File Storage Cabinet	24	18	72	177	23	WV2418-72BBFTR	\$2,934	\$3,228
	24	18	72	177	23	WV2418-72BBFTL	\$2,934	\$3,228
	20	18	72	154	19	WV2018-72BBFTR	\$2,788	\$3,068
	20	18	72	154	19	WV2018-72BBFTL	\$2,788	\$3,068

**NOW!**



right shown

- two adjustable shelves
- locking door available, specify and add \$105 list
- box/box/file pedestal
- pedestal front locking

57" h Box/Box/File Storage Cabinet	24	18	56 <sup>11</sup> / <sub>16</sub>	130	18	WV2418-57BBFTR	\$2,555	\$2,811
	24	18	56 <sup>11</sup> / <sub>16</sub>	130	18	WV2418-57BBFTL	\$2,555	\$2,811
	20	18	56 <sup>11</sup> / <sub>16</sub>	114	15	WV2018-57BBFTR	\$2,428	\$2,672
	20	18	56 <sup>11</sup> / <sub>16</sub>	114	15	WV2018-57BBFTL	\$2,428	\$2,672

**NOW!**



right shown

- two adjustable shelves
- locking door available, specify and add \$105 list
- box/box/file pedestal
- pedestal front locking

**To Order, Specify:**

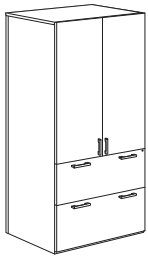
- ① Model Number
- ② Wood Species - Cherry (CH1), Maple (MA1), Walnut (WA1) or Double Cut (see page 228)
- ③ Finish Color (see page 229)
- ④ Pull Style and Color (see page 233)
- ⑤ Other Product Options (see page 229)

When ordering Quickship products, place a "Q" in front of model number.  
Example: QV3072DD

**NOW!**  
Need it.  
JSI Quickship

Description	D	W	H	CTN WT	CU FT	① Model	Flat Cut List Price	Double Cut List Price
84" h Box/Box/Lateral File Storage Cabinet	24	36	84	335	50	VV2436-84BBFT	\$4,107	\$4,519
	24	30	84	322	42	VV2430-84BBFT	\$3,834	\$4,218
	20	36	84	292	42	VV2036-84BBFT	\$3,903	\$4,294
	20	30	84	281	36	VV2030-84BBFT	\$3,643	\$4,007

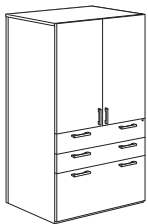
**NOW!**



- three adjustable shelves
- locking doors available, specify and add \$105 list
- box/box/lateral file
- pedestal locking

72" h Box/Box/Lateral File Storage Cabinet	24	36	72	285	43	VV2436-72BBFT	\$3,918	\$4,311
	24	30	72	271	36	VV2430-72BBFT	\$3,744	\$4,119
	20	36	72	248	36	VV2036-72BBFT	\$3,723	\$4,095
	20	30	72	236	31	VV2030-72BBFT	\$3,557	\$3,913

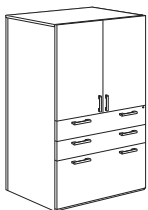
**NOW!**



- two adjustable shelves
- locking doors available, specify and add \$105 list
- box/box/file lateral
- pedestal locking

57" h Box/Box/Lateral File Storage Cabinet	24	36	56 <sup>11</sup> / <sub>16</sub>	216	34	VV2436-57BBFT	\$3,337	\$3,671
	24	30	56 <sup>11</sup> / <sub>16</sub>	201	29	VV2430-57BBFT	\$3,085	\$3,394
	20	36	56 <sup>11</sup> / <sub>16</sub>	188	29	VV2036-57BBFT	\$3,170	\$3,488
	20	30	56 <sup>11</sup> / <sub>16</sub>	175	24	VV2030-57BBFT	\$2,932	\$3,226

**NOW!**



- two adjustable shelves
- locking doors available, specify and add \$105 list
- box/box/file lateral
- pedestal locking

VISION - VENEER

Description	D	W	H	CTN WT	CU FT	① Model	Flat Cut List Price	Double Cut List Price
84" h Multi-File Storage Cabinet	24	30	84	344	42	VW2430-84MFR	\$4,127	\$4,540
	24	30	84	344	42	VW2430-84MFL	\$4,127	\$4,540
	20	30	84	300	36	VW2030-84MFR	\$3,921	\$4,314
	20	30	84	300	36	VW2030-84MFL	\$3,921	\$4,314

**NOW!**



right shown

- three adjustable shelves
- locking doors available, specify and add \$105 list
- pedestal locking

72" h Multi-File Storage Cabinet	24	30	72	331	36	VW2430-72MFR	\$3,939	\$4,334
	24	30	72	331	36	VW2430-72MFL	\$3,939	\$4,334
	20	30	72	288	31	VW2030-72MFR	\$3,742	\$4,116
	20	30	72	288	31	VW2030-72MFL	\$3,742	\$4,116

**NOW!**



right shown

- two adjustable shelves
- locking doors available, specify and add \$105 list
- pedestal locking

57" h Multi-File Storage Cabinet	24	30	56 <sup>11</sup> / <sub>16</sub>	216	34	VW2430-57MFR	\$3,418	\$3,761
	24	30	56 <sup>11</sup> / <sub>16</sub>	216	34	VW2430-57MFL	\$3,418	\$3,761
	20	30	56 <sup>11</sup> / <sub>16</sub>	188	29	VW2030-57MFR	\$3,248	\$3,574
	20	30	56 <sup>11</sup> / <sub>16</sub>	188	29	VW2030-57MFL	\$3,248	\$3,574

**NOW!**



right shown

- two adjustable shelves
- locking doors available, specify and add \$105 list
- pedestal locking

**To Order, Specify:**

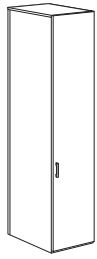
- ① Model Number
- ② Wood Species - Cherry (CH1), Maple (MA1), Walnut (WA1) or Double Cut (see page 228)
- ③ Finish Color (see page 229)
- ④ Pull Style and Color (see page 233)
- ⑤ Other Product Options (see page 229)

When ordering Quickship products, place a "Q" in front of model number.  
Example: QVW3072DD

**NOW!**  
Need it.  
JSI Quickship

VISION - VENEER

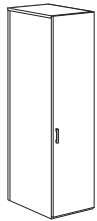
Description	D	W	H	CTN WT	CU FT	① Model	Flat Cut List Price	Double Cut List Price
84" h Storage Cabinet	24	18	84	137	26	VV2418-84HR	\$2,674	\$2,942
<b>NOW!</b>	24	18	84	137	26	VV2418-84HL	\$2,674	\$2,942
	20	18	84	120	22	VV2018-84HR	\$2,540	\$2,795
	20	18	84	120	22	VV2018-84HL	\$2,540	\$2,795



right shown

- one fixed shelf 29 1/2" from cabinet floor
- four adjustable shelves
- locking doors available, specify and add \$105 list

72" h Storage Cabinet	24	18	72	165	23	VV2418-72HR	\$2,285	\$2,514
<b>NOW!</b>	24	18	72	165	23	VV2418-72HL	\$2,285	\$2,514
	20	18	72	144	19	VV2018-72HR	\$2,172	\$2,389
	20	18	72	144	19	VV2018-72HL	\$2,172	\$2,389



right shown

- one fixed shelf 29 1/2" from cabinet floor
- three adjustable shelves
- locking doors available, specify and add \$105 list

57" h Storage Cabinet	24	18	56 11/16	117	18	VV2418-57HR	\$1,998	\$2,198
<b>NOW!</b>	24	18	56 11/16	117	18	VV2418-57HL	\$1,998	\$2,198
	20	18	56 11/16	102	15	VV2018-57HR	\$1,898	\$2,088
	20	18	56 11/16	102	15	VV2018-57HL	\$1,898	\$2,088



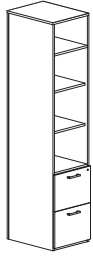
right shown

- three adjustable shelves
- locking doors available, specify and add \$105 list

VISION - VENEER

Description	D	W	H	CTN WT	CU FT	① Model	Flat Cut List Price	Double Cut List Price
84" h Open Top, File/File Storage Cabinet	24	18	84	197	26	VW2418-84FFO	\$3,053	\$3,358
	20	18	84	172	22	VW2018-84FFO	\$2,901	\$3,191

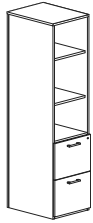
**NOW!**



- two adjustable shelves, top shelf fixed
- file/file pedestal
- pedestal front locking

72" h Open Top, File/File Storage Cabinet	24	18	72	185	23	VW2418-72FFO	\$2,817	\$3,099
	20	18	72	161	19	VW2018-72FFO	\$2,676	\$2,944

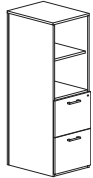
**NOW!**



- two adjustable shelves
- file/file pedestal
- pedestal front locking

57" h Open Top, File/File Storage Cabinet	24	18	56 <sup>11</sup> / <sub>16</sub>	125	18	VW2418-57FFO	\$2,451	\$2,697
	20	18	56 <sup>11</sup> / <sub>16</sub>	109	15	VW2018-57FFO	\$2,329	\$2,562

**NOW!**



- one adjustable shelf
- file/file pedestal
- pedestal front locking

**To Order, Specify:**

- ① Model Number
- ② Wood Species - Cherry (CH1), Maple (MA1), Walnut (WA1) or Double Cut (see page 228)
- ③ Finish Color (see page 229)
- ④ Pull Style and Color (see page 233)
- ⑤ Other Product Options (see page 229)

When ordering Quickship products, place a "Q" in front of model number.  
Example: QVW3072DD





Description	D	W	H	CTN WT	CU FT	① Model	Flat Cut List Price	Double Cut List Price
84" h Open Top, Box/Box/File Storage Cabinet	24	18	84	197	26	VV2418-84BBFO	\$3,062	\$3,369
	20	18	84	172	22	VV2018-84BBFO	\$2,910	\$3,202

**NOW!**



- two adjustable shelves, top shelf fixed
- box/box/file pedestal
- pedestal front locking

72" h Open Top, Box/Box/File Storage Cabinet	24	18	72	185	23	VV2418-72BBFO	\$2,826	\$3,110
	20	18	72	161	19	VV2018-72BBFO	\$2,685	\$2,954

**NOW!**



- two adjustable shelves
- box/box/file pedestal
- pedestal front locking

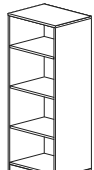
57" h Open Top, Box/Box/File Storage Cabinet	24	18	56 <sup>11</sup> / <sub>16</sub>	125	18	VV2418-57BBFO	\$2,462	\$2,708
	20	18	56 <sup>11</sup> / <sub>16</sub>	109	15	VV2018-57BBFO	\$2,339	\$2,573

**NOW!**



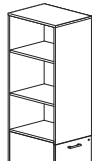
- one adjustable shelf
- box/box/file pedestal
- pedestal front locking

VISION - VENEER

Description	D	W	H	CTN WT	CU FT	① Model	Flat Cut List Price	Double Cut List Price
84" h File/File Storage Cabinet with Side Access	24	18	84	197	26	WV2418-84FFSSTR	\$3,189	\$3,509
	24	18	84	197	26	WV2418-84FFSSTL	\$3,189	\$3,509
	20	18	84	172	22	WV2018-84FFSSTR	\$3,031	\$3,334
	20	18	84	172	22	WV2018-84FFSSTL	\$3,031	\$3,334

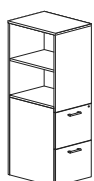
- two adjustable shelves, top shelf fixed
- file/file pedestal
- pedestal front locking

right shown ▲

72" h File/File Storage Cabinet with Side Access	24	18	72	185	23	WV2418-72FFSSTR	\$2,947	\$3,242
	24	18	72	185	23	WV2418-72FFSSTL	\$2,947	\$3,242
	20	18	72	161	19	WV2018-72FFSSTR	\$2,800	\$3,080
	20	18	72	161	19	WV2018-72FFSSTL	\$2,800	\$3,080

- two adjustable shelves
- file/file pedestal
- pedestal front locking

right shown ▲

57" h File/File Storage Cabinet with Side Access	24	18	56 11/16	125	18	WV2418-57FFSSTR	\$2,551	\$2,806
	24	18	56 11/16	125	18	WV2418-57FFSSTL	\$2,551	\$2,806
	20	18	56 11/16	109	15	WV2018-57FFSSTR	\$2,425	\$2,667
	20	18	56 11/16	109	15	WV2018-57FFSSTL	\$2,425	\$2,667

- one adjustable shelf
- file/file pedestal
- pedestal front locking

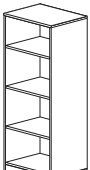
right shown ▲

**To Order, Specify:**

- ① Model Number
- ② Wood Species - Cherry (CH1), Maple (MA1), Walnut (WA1) or Double Cut (see page 228)
- ③ Finish Color (see page 229)
- ④ Pull Style and Color (see page 233)
- ⑤ Other Product Options (see page 229)

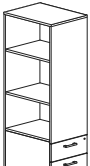
When ordering Quickship products, place a "Q" in front of model number.  
Example: QV3072DD

**NOW!**  
Need it.  
JSI Quickship

Description	D	W	H	CTN WT	CU FT	① Model	Flat Cut List Price	Double Cut List Price
84" h Box/Box/File Storage Cabinet with Side Access	24	18	84	197	26	VV2418-84BBFSSTR	\$3,199	\$3,519
	24	18	84	197	26	VV2418-84BBFSSTL	\$3,199	\$3,519
	20	18	84	172	22	VV2018-84BBFSSTR	\$3,040	\$3,345
	20	18	84	172	22	VV2018-84BBFSSTL	\$3,040	\$3,345


- two adjustable shelves, top shelf fixed
- box/box/file pedestal
- pedestal front locking

right shown ▲

72" h Box/Box/File Storage Cabinet with Side Access	24	18	72	185	23	VV2418-72BBFSSTR	\$2,956	\$3,252
	24	18	72	185	23	VV2418-72BBFSSTL	\$2,956	\$3,252
	20	18	72	161	19	VV2018-72BBFSSTR	\$2,809	\$3,091
	20	18	72	161	19	VV2018-72BBFSSTL	\$2,809	\$3,091

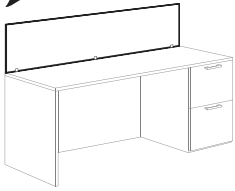
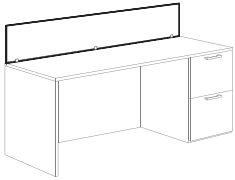
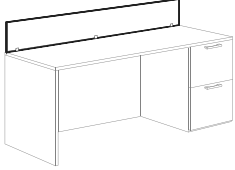
- two adjustable shelves
- box/box/file pedestal
- pedestal front locking

right shown ▲

57" h Box/Box/File Storage Cabinet with Side Access	24	18	56 <sup>11</sup> / <sub>16</sub>	125	18	VV2418-57BBFSSTR	\$2,561	\$2,818
	24	18	56 <sup>11</sup> / <sub>16</sub>	125	18	VV2418-57BBFSSTL	\$2,561	\$2,818
	20	18	56 <sup>11</sup> / <sub>16</sub>	109	15	VV2018-57BBFSSTR	\$2,433	\$2,677
	20	18	56 <sup>11</sup> / <sub>16</sub>	109	15	VV2018-57BBFSSTL	\$2,433	\$2,677

- one adjustable shelf
- box/box/file pedestal
- pedestal front locking

right shown ▲

Description	D	W	H	CTN WT	CU FT	① Model	List Price
	1/4	71 1/4	15	7	3	VS1572ASR	\$691
	1/4	65 1/4	15	7	2	VS1566ASR	\$641
	1/4	59 1/4	15	6	2	VS1560ASR	\$591
	1/4	53 1/4	15	6	2	VS1554ASR	\$543
	1/4	47 1/4	15	6	2	VS1548ASR	\$494
	1/4	41 1/4	15	5	2	VS1542ASR	\$447
	1/4	35 1/4	15	5	1	VS1536ASR	\$389
	1/4	29 1/4	15	4	1	VS1530ASR	\$342
	1/4	23 1/4	15	4	1	VS1524ASR	\$293
	1/4	71 1/4	12	7	2	VS1272ASR	\$570
	1/4	65 1/4	12	7	2	VS1266ASR	\$530
	1/4	59 1/4	12	6	2	VS1260ASR	\$489
	1/4	53 1/4	12	6	2	VS1254ASR	\$451
	1/4	47 1/4	12	6	2	VS1248ASR	\$412
	1/4	41 1/4	12	5	2	VS1242ASR	\$374
	1/4	35 1/4	12	5	1	VS1236ASR	\$325
	1/4	29 1/4	12	4	1	VS1230ASR	\$287
	1/4	23 1/4	12	4	1	VS1224ASR	\$248
	1/4	71 1/4	9	6	2	VS0972ASR	\$511
	1/4	65 1/4	9	6	2	VS0966ASR	\$475
	1/4	59 1/4	9	5	2	VS0960ASR	\$439
	1/4	53 1/4	9	5	2	VS0954ASR	\$406
	1/4	47 1/4	9	5	1	VS0948ASR	\$371
	1/4	41 1/4	9	5	1	VS0942ASR	\$338
	1/4	35 1/4	9	4	1	VS0936ASR	\$294
	1/4	29 1/4	9	4	1	VS0930ASR	\$261
	1/4	23 1/4	9	4	1	VS0924ASR	\$227

- frosted acrylic
- mounts to top of worksurface
- mounting hardware included
- field installed

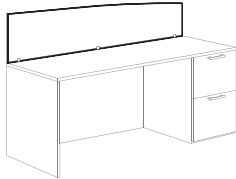
**To Order, Specify:**

- ① Model Number
- ② Wood Species - Cherry (CH1), Maple (MA1), Walnut (WA1) or Double Cut (see page 228)
- ③ Finish Color (see page 229)
- ④ Pull Style and Color (see page 233)
- ⑤ Other Product Options (see page 229)

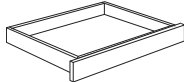
When ordering Quickship products, place a "Q" in front of model number.  
Example: QVV3072DD



VISION - VENEER

Description	D	W	H	CTN WT	CU FT	① Model	List Price
<b>Fin Privacy Screen</b> 	1/4	71 1/4	15	7	3	VS1572ASF	\$793
	1/4	65 1/4	15	7	2	VS1566ASF	\$745
	1/4	59 1/4	15	6	2	VS1560ASF	\$695
	1/4	53 1/4	15	6	2	VS1554ASF	\$646
	1/4	47 1/4	15	6	2	VS1548ASF	\$598
	1/4	41 1/4	15	5	2	VS1542ASF	\$524
	1/4	35 1/4	15	5	1	VS1536ASF	\$467
	1/4	29 1/4	15	4	1	VS1530ASF	\$419
	1/4	23 1/4	15	4	1	VS1524ASF	\$371
	1/4	71 1/4	12	7	3	VS1272ASF	\$674
	1/4	65 1/4	12	7	2	VS1266ASF	\$634
	1/4	59 1/4	12	6	2	VS1260ASF	\$593
	1/4	53 1/4	12	6	2	VS1254ASF	\$555
	1/4	47 1/4	12	6	2	VS1248ASF	\$516
	1/4	41 1/4	12	5	2	VS1242ASF	\$452
	1/4	35 1/4	12	5	1	VS1236ASF	\$404
1/4	29 1/4	12	4	1	VS1230ASF	\$366	
1/4	23 1/4	12	4	1	VS1224ASF	\$327	

- arc spans 12" to 15" for 15" high and 9" to 12" for 12" high
- frosted acrylic
- mounts to top of worksurface
- mounting hardware included
- field installed

							Flat Cut List Price	Double Cut List Price
<b>Center Drawer</b> 	18	27	2 1/2	12	2	W1825CD	\$300	\$335

- interior dimensions 22 3/4" wide X 15 1/2" deep X 2 1/8" high
- drawer front 27" wide
- field installed
- locking not available
- mounts to bottom of worksurface
- available on any double or single pedestal desk, not available on cockpit or peninsula desks

**To Order, Specify:**

- ① Model Number
- ② Wood Species - Cherry (CH1), Maple (MA1), Walnut (WA1) or Double Cut (see page 228)
- ③ Finish Color (see page 229)

When ordering Quickship products, place a "Q" in front of model number.  
 Example: QV3072DD



Vision - Veneer - Notes



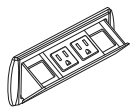
## Accessories, Power and Data





## Accessories - Overview

### Power Accessories



Power and Data Tilt Out  
Page 409



Mini Power and Data Tilt Up  
Page 409

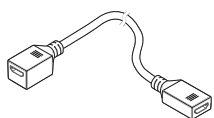


Mini Power Tilt Up  
Page 409

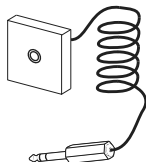


Mini Power and USB Tilt Up  
Page 409

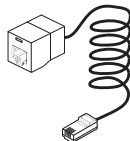
### Type 3 Telecom Jacks



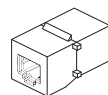
HDMI Connector  
Page 410



Mini Stereo Jack  
Page 410

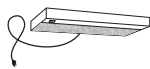


Network Jack  
Page 410

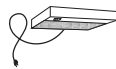


Voice Coupler  
Page 410

### Task Lights



48" w Task Light  
Page 412



24" w Task Light  
Page 412



31" w LED Starter Task Light  
Page 412



31" w LED Linking Adder Task Light  
Page 412



17" w LED Starter Task Light  
Page 413

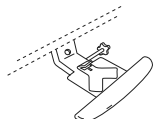


17" w LED Linking Adder Task Light  
Page 413



Motion Sensor for Task Lights  
Page 413

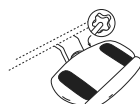
### Keyboard Accessories



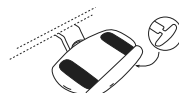
Keyboard Clamp with Wrist Rest  
Page 414



Keyboard Clamp Mouse Pad  
Page 414



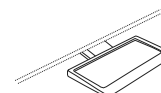
Articulating Keyboard Tray  
Page 414



Articulating Keyboard Tray  
Page 414



Keyboard Tray Mouse Pad  
Page 414



Keyboard Drawer  
Page 415



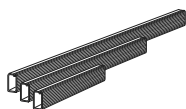
Keyboard Tray Mouse Pad  
Page 415

### Monitor Support Arm

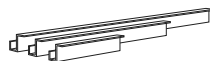


Monitor Support Arm  
Page 415

### Wire Management Accessories



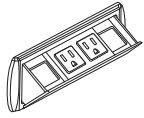
Wire Management Channel  
Page 415



Wire Management Trough  
Page 415

Description	D	W	H	CTN WT	CU FT	① Model	List Price
-------------	---	---	---	-----------	----------	---------	------------

<b>Power and Data Tilt Out</b>	3	7		3		<b>EC3</b>	<b>\$305</b>
--------------------------------	---	---	--	---	--	------------	--------------



(standard location)

- spring assist tilt up access
- two power receptacles (120 volt, 15amp) and two openings for voice/data jacks
- adapter kit provided to accept jacks from most port manufacturers (see page 411)
- accepts up to two Type 3 Telecom Jacks (see page 410)
- 72" power cord with molded plug
- drop in field installation required
- cut out provided in center of back panel of storage cabinet below tackboard
- UL listed component
- Black or Silver finish

<b>Mini Power and Data Tilt Up</b>	4 1/4	5 1/2		6	1	<b>EC10</b>	<b>\$352</b>
------------------------------------	-------	-------	--	---	---	-------------	--------------



- fluid one touch tilt up access
- one power receptacle - 120 volt; 15 amp and one voice/data port
- adapter kit provided to accept jacks from most port manufacturers (see page 411)
- accepts one Type 3 Telecom Jack (see page 410)
- 72" power cord with molded plug
- drop in field installation required
- cut out provided in top at specified location (see page 411)
- UL listed component
- Black or Silver finish

<b>Mini Power Tilt Up</b>	4 1/4	5 1/2		6	1	<b>EC11</b>	<b>\$367</b>
---------------------------	-------	-------	--	---	---	-------------	--------------



- fluid one touch tilt up access
- two power receptacles - 120 volt; 15 amp
- 72" power cord with molded plug
- drop in field installation required
- cut out provided in top at specified location (see page 411)
- UL listed component
- Black or Silver finish

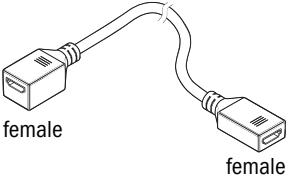
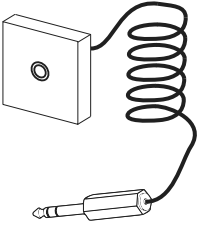
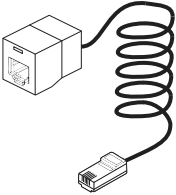
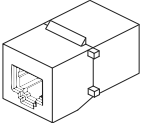
<b>Mini Power and USB Tilt Up</b>	4 1/4	5 1/2		6	1	<b>EC12</b>	<b>\$458</b>
-----------------------------------	-------	-------	--	---	---	-------------	--------------



- fluid one touch tilt up access
- one power receptacle - 120 volt; 15 amp dual powered USB
- 72" power cord with molded plug
- drop in field installation required
- cut out provided in top at specified location (see page 411)
- UL listed component
- Black or Silver finish

**To Order, Specify:**

- ① Model number

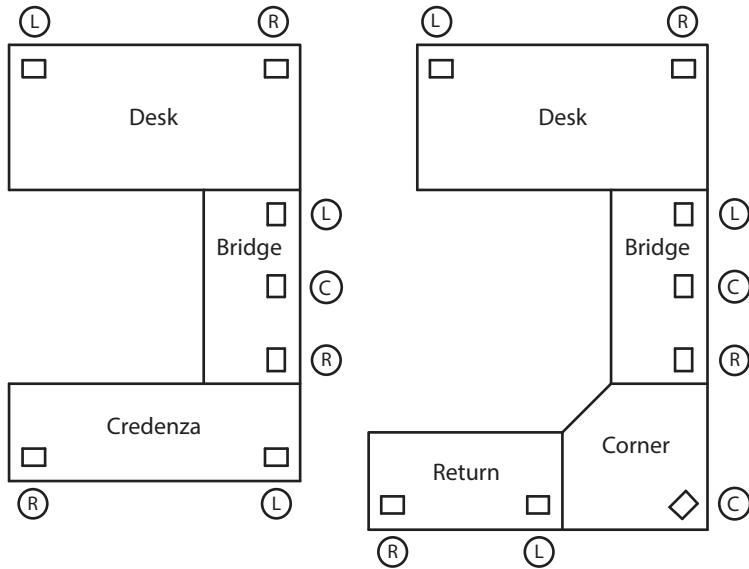
Description	D	W	H	CTN WT	CU FT	① Model	List Price
<b>HDMI Connector</b>  <ul style="list-style-type: none"> <li>· HDMI coupler</li> <li>· 18" cord</li> <li>· female to female connection</li> </ul>						<b>TCP301</b>	<b>\$83</b>
<b>Mini Stereo Jack</b>  <ul style="list-style-type: none"> <li>· 3.5 mm Mini Stereo Jack</li> <li>· 10 foot cord</li> <li>· female to male connection</li> </ul>						<b>TCP302</b>	<b>\$23</b>
<b>Network Jack</b>  <ul style="list-style-type: none"> <li>· Cat5e RJ-45 Panduit Jack</li> <li>· Pre-terminated</li> <li>· 9 foot cord</li> <li>· 8-Pin</li> </ul>						<b>TCP303</b>	<b>\$75</b>
<b>Voice Coupler</b>  <ul style="list-style-type: none"> <li>· AMP Category 3, RJ-11</li> <li>· 6-Pin</li> <li>· connects to standard phone cord</li> </ul>						<b>TCP304</b>	<b>\$75</b>

ACCESSORIES

**To Order, Specify:**

① Model Number

**Standard casegoods cut out locations:**



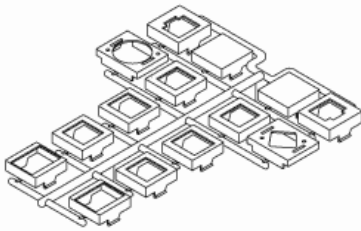
- Specify - Location when ordering on desk, return, computer corner, bridge and credenza - please provide drawing.
- Computer corner units - power/data replaces grommet.
- Standard power and data unit locations are indicated from user side of desk, return, computer corner bridge or credenza.

**NOTE:** Verify fit of data jack in adapter before ordering large quantities as manufacturer designs may change without notice

**Data Adapter Applications**

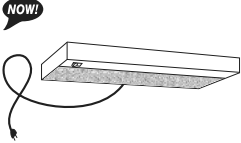
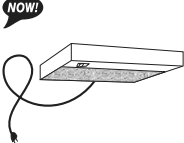

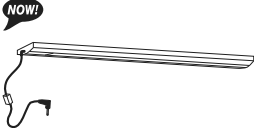
Data adapter kits ship with each power and data unit.

Adapter plates are marked on the back with letter designators to indicate the data jack manufacturer, series and style. Websites are listed below for quick reference to verify data jack series or style.

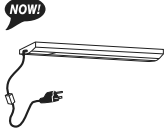
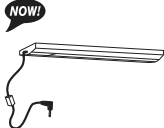
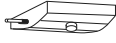


**NOTE:** Verify fit of data jack in adapter before ordering large quantities as manufacturer designs may change without notice.

Adapter	Manufacturer	Website
AA	Uniprise/Systimax/Avaya	www.unipriseresolutions.com
BB	Tyco SL and 100 Connect Series Modular Jacks	www.ampconnect.com
BB	Siemon Keystone Style	www.siemon.com
BB	Allen Tel Versa Tap Series	www.allentel.com
BB	Leviton Quick Port® Series	www.leviton.com
BB	Nordx Keystone Style	www.nordx.com
CC	Tyco SL Coupler Series	www.ampconnect.com
CC	Krone 6000 Series	www.adc.com
CC	Hubbell Xcelerator™ Keystone Series	www.hubbell.com
DD	Blank (no coupler/jack)	
EE	Ortronics TracJack Series	www.ortronics.com
FF	Panduit Mini-Com Series	www.panduit.com
GG	Microphone jack/3-pin XLR, solder type only	
HH	Video Monitor jack/DB-15, panel mount solder style	

Description	D	W	H	CTN WT	CU FT	① Model	List Price
<b>48" w Task Light</b>  <ul style="list-style-type: none"> <li>· use with overhead cabinets 60" wide and larger</li> <li>· uses slim energy-efficient T5 - 3500k lamp (included)</li> <li>· two position on - off switch</li> <li>· prismatic lens with electronic ballast</li> <li>· ETL listed</li> <li>· factory installation optional (no additional charge); please specify unit where light is to be installed</li> </ul>	4 ½	48	1 ½	6	1	<b>48T5L</b>	<b>\$370</b>
<b>24" w Task Light</b>  <ul style="list-style-type: none"> <li>· use with overhead cabinets 30" wide and larger</li> <li>· uses slim energy-efficient T5 - 3500k lamp (included)</li> <li>· two position on - off switch</li> <li>· prismatic lens with electronic ballast</li> <li>· ETL listed</li> <li>· factory installation optional (no additional charge); please specify unit where light is to be installed</li> </ul>	4 ½	24	1 ½	4	1	<b>24T5L</b>	<b>\$256</b>
<b>31" w LED Starter Task Light</b>  <ul style="list-style-type: none"> <li>· use with overhead cabinets 42" wide and larger</li> <li>· slim energy-efficient stand alone or starter LED lamp</li> <li>· soft touch switching with instant on to fade way off</li> <li>· infinite dimming with last state memory (dimming range 100% to 15%)</li> <li>· automatic time off after 10 hours</li> <li>· includes power supply</li> <li>· ETL listed</li> <li>· GSA compliant</li> <li>· factory installation optional (no additional charge); please specify unit where light is to be installed</li> </ul>	2	31	½	4	1	<b>TL31LED-S</b>	<b>\$588</b>
<b>31" w LED Linking Adder Task Light</b>  <ul style="list-style-type: none"> <li>· use with overhead cabinets 42" wide and larger</li> <li>· slim energy-efficient LED lamp for linking to a starter task light</li> <li>· string may contain 1 starter with up to five adders</li> <li>· soft touch switching with instant on to fade way off</li> <li>· infinite dimming with last state memory (dimming range 100% to 15%)</li> <li>· automatic time off after 10 hours</li> <li>· ETL listed</li> <li>· GSA compliant</li> <li>· factory installation optional (no additional charge); please specify unit where light is to be installed</li> </ul>	2	31	½	4	1	<b>TL31LED-A</b>	<b>\$519</b>

ACCESSORIES

Description	D	W	H	CTN WT	CU FT	① Model	List Price
<b>17" w LED Starter Task Light</b> 	2	17	1/2	2	1	TL17LED-S	\$477
<ul style="list-style-type: none"> <li>• use with overhead cabinets 30" wide and larger</li> <li>• slim energy-efficient stand alone or starter LED lamp</li> <li>• soft touch switching with instant on to fade way off</li> <li>• infinite dimming with last state memory (dimming range 100% to 15%)</li> <li>• automatic time off after 10 hours</li> <li>• includes power supply</li> <li>• ETL listed</li> <li>• GSA compliant</li> <li>• factory installation optional (no additional charge); please specify unit where light is to be installed</li> </ul>							
<b>17" w LED Linking Adder Task Light</b> 	2	17	1/2	2	1	TL17LED-A	\$327
<ul style="list-style-type: none"> <li>• use with overhead cabinets 30" wide and larger</li> <li>• slim energy-efficient LED lamp for linking to a starter task light</li> <li>• string may contain 1 starter with up to five adders</li> <li>• soft touch switching with instant on to fade way off</li> <li>• infinite dimming with last state memory (dimming range 100% to 15%)</li> <li>• automatic time off after 10 hours</li> <li>• ETL listed</li> <li>• GSA compliant</li> <li>• factory installation optional (no additional charge); please specify unit where light is to be installed</li> </ul>							
<b>Motion Sensor for Task Lights</b> 	2	3	1/2	1	1	TL03-OCPS	\$321
<ul style="list-style-type: none"> <li>• occupancy sensor for LED task lights</li> <li>• integrates with TL31LED or TL17LED</li> <li>• shuts off after 30 minutes of inactivity</li> <li>• connects to end of light fixture (adds 3" to length of fixture)</li> <li>• one sensor controls starter and connected adders</li> </ul>							

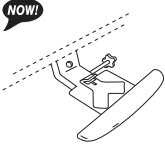

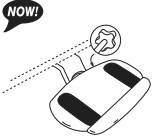
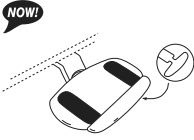

ACCESSORIES

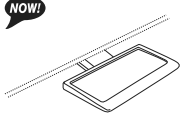

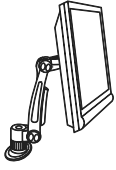
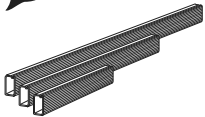
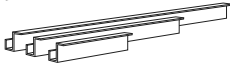
**To Order, Specify:**

① Model number

When ordering Quickship products, place a "Q" in front of model number.  
 Example: QAK1

**NOW!**  
 Need it.  
 JSI Quickship

Description	D	W	H	CTN WT	CU FT	① Model	List Price
<b>Keyboard Clamp with Wrist Rest</b>  <ul style="list-style-type: none"> <li>· clamps hold keyboard in place</li> <li>· single soft touch knob provides clamping adjustment for both height and tilt</li> <li>· compatible with MT1 Clamp Mouse Pad only</li> </ul>	10 1/2	20 1/2	3	4		AK1	\$422
<b>Keyboard Clamp Mouse Pad</b>  <ul style="list-style-type: none"> <li>· adjusts for user comfort</li> <li>· 8" x 8"</li> <li>· for left or right hand operation</li> <li>· compatible with AK1 Keyboard Clamp only</li> </ul>	8	8	1/4	4		MT1	\$152
<b>Articulating Keyboard Tray</b>  <ul style="list-style-type: none"> <li>· single soft touch knob provides clamping adjustment for both height and tilt</li> <li>· platform has injection molded construction with non skid pads to prevent keyboard movement</li> <li>· compatible with MT2 Mouse Pad</li> </ul>	11	23	3	11		AK2	\$445
<b>Articulating Keyboard Tray</b>  <ul style="list-style-type: none"> <li>· one touch spring assist adjustable mechanism with 18" track</li> <li>· platform has injection molded construction with non skid pads to prevent keyboard movement</li> <li>· compatible with MT2 Mouse Pad</li> </ul>	11	23	3	11		AK3	\$493
<b>Keyboard Tray Mouse Pad</b>  <ul style="list-style-type: none"> <li>· adjusts for user comfort</li> <li>· 8" x 8"</li> <li>· for left or right hand operation</li> <li>· compatible with AK2 and AK3 Keyboard Tray</li> </ul>	8	8	1/4	2		MT2	\$152

Description	D	W	H	CTN WT	CU FT	① Model	List Price
<b>Keyboard Drawer</b>  <ul style="list-style-type: none"> <li>for use with 48" return</li> <li>requires a minimum of 24" clearance side to side</li> <li>one touch spring assist adjustable mechanism with 18" track</li> <li>compatible with MT4 Mouse Pad only</li> <li>wood tray requires finish selection; see component finishes for selection</li> </ul>	14	22 1/2	3 1/2	9		AK4	\$528
<b>Keyboard Tray Mouse Pad</b>  <ul style="list-style-type: none"> <li>adjusts for user comfort</li> <li>8" x 8"</li> <li>for left or right hand operation</li> <li>compatible with AK4 Keyboard Drawer only</li> </ul>	8	8	1/4	2		MT4	\$152
<b>Monitor Support Arm</b>  <ul style="list-style-type: none"> <li>360 degree swivel</li> <li>adjusts height, tilt and distance of monitor screen to user</li> <li>integrated cable management</li> <li>grommet and edge clamp mount included</li> <li>black finish</li> <li>monitor not included</li> <li>will fit monitors made to the VESA standard of 75 mm or 100 mm hole spacing in a square configuration</li> </ul>	12	6	17	9		AMA3B	\$464
<b>Wire Management Channel</b>  <ul style="list-style-type: none"> <li>available in 12", 24" and 36" increments</li> <li>field installed with adhesive tape provided</li> </ul>	1/2	36	1	4		36WC	\$54
	1/2	24	1	3		24WC	\$49
	1/2	12	1	2		12WC	\$42
<b>Wire Management Trough</b>  <ul style="list-style-type: none"> <li>available in 12", 24" and 36" increments</li> <li>field installed with screws provided</li> </ul>	2 1/2	36	2 1/2	3		36WCT	\$108
	2 1/2	24	2 1/2	3		24WCT	\$98
	2 1/2	12	2 1/2	2		12WCT	\$83

**To Order, Specify:**

① Model number

When ordering Quickship products, place a "Q" in front of model number.  
 Example: QAK1

**NOW!**  
 Need it.  
 JSI Quickship



# Index

## Accessories

12WC	415
12WCT	415
24T5L	412
24WC	415
24WCT	415
36WC	415
36WCT	415
48T5L	412
AK1	414
AK2	414
AK3	414
AK4	415
AMA3B	415
EC10	409
EC11	409
EC12	409
EC3	409
MT1	414
MT2	414
MT4	415
TCP301	410
TCP302	410
TCP303	410
TCP304	410
TL03-OCPS	413
TL17LED-A	413
TL17LED-S	413
TL31LED-A	412
TL31LED-S	412

## Vision

04BB	75, 80, 181, 265, 270, 371
04SB	75, 80, 181, 265, 270, 371
12DB	75, 80, 181, 265, 270, 371
12DS	75, 80, 181, 265, 270, 371
18HB	75, 80, 181, 265, 270, 371
18HS	75, 80, 181, 265, 270, 371
18UB	75, 80, 181, 265, 270, 371
18US	75, 80, 181, 265, 270, 371
24HB	75, 80, 181, 265, 270, 371
24HS	75, 80, 181, 265, 270, 371
24UB	75, 80, 181, 265, 270, 371
24US	75, 80, 181, 265, 270, 371
AC203CUP	129, 319
AC313FILE	129, 319
AC403TRAY	129, 319
AC408TRAY	129, 319
AC912PAP	129, 319
VL0940TDM	87
VL0946TDM	87
VL0952TDM	67

VL0958TDM	67
VL0964TDM	67
VL10102WCU	162
VL10108WCU	162
VL1024TSP	96
VL1030TSP	96
VL1030WCU	162
VL1036TSP	96
VL1036WCU	162
VL1042TSP	96
VL1042WCU	162
VL1048TSP	96
VL1048WCU	162
VL1054WCU	162
VL1060WCU	162
VL1066WCU	162
VL1072WCU	162
VL1078WCU	162
VL1084WCU	162
VL1090WCU	162
VL1096WCU	162
VL12SP	100
VL1366TC	178
VL1372TC	178
VL1428TS	178
VL1434TS	178
VL1440TS	178
VL1520SK	200
VL1524SK	200
VL1530BOO	176
VL1530BTS	176
VL1530DBOO	174
VL1530DBTS	174
VL1530DWO	149
VL1530WDTS	149
VL1530WOO	156
VL1530WTS	156
VL1536BOO	176
VL1536BTS	176
VL1536DBOO	174
VL1536DBTS	174
VL1536DWO	149
VL1536WDTS	149
VL1536WOO	156
VL1536WTS	156
VL1542BOO	176
VL1542BTS	176
VL1542DBOO	174
VL1542DBTS	174
VL1542DWO	149
VL1542WDTS	149
VL1542WOO	156
VL1542WTS	156
VL1548BOO	176
VL1548BTS	176
VL1548DBOO	174
VL1548DBTS	174
VL1548DWO	149
VL1548WDTS	149
VL1548WOO	156
VL1548WTS	156
VL1554BOO	176
VL1554BTS	176
VL1554DBOO	174

VL1554DBTS	174
VL1554DWO	149
VL1554WDTS	149
VL1554WOO	156
VL1554WTS	156
VL16102DGSO	104
VL16102DGSOC	107
VL16102DSD	103
VL16102DSDC	106
VL16102DSO	102
VL16102DSOC	105
VL16102GSMOC	115
VL16102GSO	110
VL16102GSOC	113
VL16102SD	109
VL16102SDC	112
VL16102SMOC	114
VL16102SO	108
VL16102SOC	111
VL16102WDGSO	152
VL16102WDGSO	155
VL16102WDSO	151
VL16102WDSDC	154
VL16102WDSO	150
VL16102WDSOC	153
VL16102WGSO	158
VL16102WGSOC	161
VL16102WSD	157
VL16102WSDC	160
VL16102WSO	156
VL16102WSOC	159
VL16108DGSO	104
VL16108DGSOC	107
VL16108DSD	103
VL16108DSDC	106
VL16108DSO	102
VL16108DSOC	105
VL16108GSMOC	115
VL16108GSO	110
VL16108GSOC	113
VL16108SD	109
VL16108SDC	112
VL16108SMOC	114
VL16108SO	108
VL16108SOC	111
VL16108WDGSO	152
VL16108WDGSO	155
VL16108WDSO	151
VL16108WDSDC	154
VL16108WDSO	150
VL16108WDSOC	153
VL16108WGSO	158
VL16108WGSOC	161
VL16108WSD	157
VL16108WSDC	160
VL16108WSO	156
VL16108WSOC	159
VL1618BO	170
VL1618DBO	168
VL1618DGSBL	169
VL1618DGSBR	169
VL1618DGSTDL	170
VL1618DGSTDR	170
VL1618DSBL	169

VL1618DSBR	169
VL1618DSTDL	170
VL1618DSTDR	170
VL1618GSBL	171
VL1618GSBR	171
VL1618GSTDL	172
VL1618GSTDR	172
VL1618SBL	171
VL1618SBR	171
VL1618STDL	172
VL1618STDR	172
VL1620MBBF	97
VL1620MFF	97
VL1620MP	199
VL1620SK	201
VL1620WEAL	98
VL1620WEAR	98
VL1624MBBF	97
VL1624MFF	97
VL1624SK	201
VL1624WEAL	98
VL1624WEAR	98
VL1630BMS	176
VL1630BMSSD	176
VL1630BO	170
VL1630DBMS	174
VL1630DBMSSD	174
VL1630DBO	168
VL1630DGBMS	175
VL1630DGSB	169
VL1630DGSO	104
VL1630DGSOC	108
VL1630DGSTD	170
VL1630DSB	169
VL1630DSD	103
VL1630SDC	106
VL1630DSO	102
VL1630DSOC	106
VL1630DSTD	170
VL1630GBMS	177
VL1630GSB	171
VL1630GSO	110
VL1630GSOC	114
VL1630GSTC	172
VL1630MBBF	97
VL1630MFF	97
VL1630PSGHD-27	144
VL1630PSGHD-2737	145
VL1630PSGHD-37	143
VL1630PSHD-27	139
VL1630PSHD-2737	140
VL1630PSHD-37	138
VL1630PSO-27	142
VL1630PSO-2737	142
VL1630PSO-37	142
VL1630PSSD-27	141
VL1630PSSD-2737	141
VL1630PSSD-37	141
VL1630SB	171
VL1630SD	109
VL1630SOC	112
VL1630STD	172

# Index

VL1630WDGSO . . . . .	152	VL1636WGSO . . . . .	158	VL1642WEAL . . . . .	98	VL1648WDSO . . . . .	151
VL1630WDGSOC . . . . .	155	VL1636WGSOC . . . . .	161	VL1642WEAR . . . . .	98	VL1648WDSDC . . . . .	154
VL1630WDSO . . . . .	151	VL1636WSD . . . . .	157	VL1642WGSOCL . . . . .	161	VL1648WDSOCL . . . . .	153
VL1630WDSDC . . . . .	154	VL1636WSDC . . . . .	160	VL1642WGSOCR . . . . .	161	VL1648WDSOCR . . . . .	153
VL1630WDSO . . . . .	150	VL1636WSO . . . . .	156	VL1642WGSOL . . . . .	158	VL1648WDSOL . . . . .	150
VL1630WDSOC . . . . .	153	VL1636WSOC . . . . .	159	VL1642WGSOR . . . . .	158	VL1648WDSOR . . . . .	150
VL1630WEAL . . . . .	98	VL1642BMSL . . . . .	176	VL1642WSD . . . . .	157	VL1648WEAL . . . . .	98
VL1630WEAR . . . . .	98	VL1642BMSR . . . . .	176	VL1642WSDC . . . . .	160	VL1648WEAR . . . . .	98
VL1630WGSO . . . . .	158	VL1642BMSSD . . . . .	176	VL1642WSOCL . . . . .	159	VL1648WGSOCL . . . . .	161
VL1630WGSOC . . . . .	161	VL1642DBMSL . . . . .	174	VL1642WSOCR . . . . .	159	VL1648WGSOCR . . . . .	161
VL1630WSD . . . . .	157	VL1642DBMSR . . . . .	174	VL1642WSOL . . . . .	156	VL1648WGSOR . . . . .	158
VL1630WSDC . . . . .	160	VL1642DBMSSD . . . . .	174	VL1642WSOR . . . . .	156	VL1648WSD . . . . .	157
VL1630WSO . . . . .	156	VL1642DGBMSL . . . . .	175	VL1648BMSL . . . . .	176	VL1648WSDC . . . . .	160
VL1630WSOC . . . . .	159	VL1642DGBMSR . . . . .	175	VL1648BMSR . . . . .	176	VL1648WSOCL . . . . .	159
VL1636BMS . . . . .	176	VL1642DGSOCL . . . . .	107	VL1648BMSSD . . . . .	176	VL1648WSOCR . . . . .	159
VL1636BMSSD . . . . .	176	VL1642DGSOCR . . . . .	107	VL1648DBMSL . . . . .	174	VL1648WSOL . . . . .	156
VL1636BO . . . . .	170	VL1642DGSOL . . . . .	104	VL1648DBMSR . . . . .	174	VL1648WSOR . . . . .	156
VL1636DBMS . . . . .	174	VL1642DGSOR . . . . .	104	VL1648DBMSSD . . . . .	174	VL1654BMS . . . . .	176
VL1636DBMSSD . . . . .	174	VL1642DSD . . . . .	103	VL1648DGBMSL . . . . .	175	VL1654BMS . . . . .	176
VL1636DBO . . . . .	168	VL1642DSDC . . . . .	106	VL1648DGBMSR . . . . .	175	VL1654BMSSD . . . . .	176
VL1636DGBMS . . . . .	175	VL1642DSOCL . . . . .	105	VL1648DGSOCL . . . . .	107	VL1654DBMS . . . . .	174
VL1636DGSB . . . . .	169	VL1642DSOCR . . . . .	105	VL1648DGSOCR . . . . .	107	VL1654DBMSSD . . . . .	174
VL1636DGSO . . . . .	104	VL1642DSOL . . . . .	102	VL1648DGSOL . . . . .	104	VL1654DGBMS . . . . .	175
VL1636DGSOC . . . . .	108	VL1642DSOR . . . . .	102	VL1648DGSOR . . . . .	104	VL1654DGSO . . . . .	104
VL1636DGSTD . . . . .	170	VL1642GBMSL . . . . .	177	VL1648DSD . . . . .	103	VL1654DGSOC . . . . .	107
VL1636DSB . . . . .	169	VL1642GBMSR . . . . .	177	VL1648SDC . . . . .	106	VL1654DSD . . . . .	103
VL1636DSD . . . . .	103	VL1642GSOCL . . . . .	113	VL1648SDOCL . . . . .	105	VL1654DSDC . . . . .	106
VL1636DSDC . . . . .	106	VL1642GSOCR . . . . .	113	VL1648DSOCR . . . . .	105	VL1654DSO . . . . .	102
VL1636DSO . . . . .	102	VL1642GSOL . . . . .	110	VL1648DSOL . . . . .	102	VL1654DSOC . . . . .	105
VL1636DSOC . . . . .	106	VL1642GSOR . . . . .	110	VL1648DSOR . . . . .	102	VL1654GBMS . . . . .	177
VL1636DSTD . . . . .	170	VL1642PSGHDL-27 . . . . .	144	VL1648GBMSL . . . . .	177	VL1654GSMOC . . . . .	115
VL1636GBMS . . . . .	177	VL1642PSGHDL-2737 . . . . .	145	VL1648GBMSR . . . . .	177	VL1654GSO . . . . .	110
VL1636GSB . . . . .	171	VL1642PSGHDL-37 . . . . .	143	VL1648GBMSSD . . . . .	176	VL1654GSOC . . . . .	113
VL1636GSO . . . . .	110	VL1642PSGHDR-27 . . . . .	144	VL1648GSOCL . . . . .	113	VL1654PSGHD-27 . . . . .	144
VL1636GSOC . . . . .	114	VL1642PSGHDR-2737 . . . . .	145	VL1648GSOCR . . . . .	113	VL1654PSGHD-2737 . . . . .	145
VL1636GSTD . . . . .	172	VL1642PSGHDR-37 . . . . .	143	VL1648GSOL . . . . .	110	VL1654PSGHD-37 . . . . .	143
VL1636MBBF . . . . .	97	VL1642PSHDL-27 . . . . .	139	VL1648GSOR . . . . .	110	VL1654PSHD-27 . . . . .	139
VL1636MFF . . . . .	97	VL1642PSHDL-2737 . . . . .	140	VL1648PSGHDL-27 . . . . .	144	VL1654PSHD-2737 . . . . .	140
VL1636PSGHD-27 . . . . .	144	VL1642PSHDL-37 . . . . .	138	VL1648PSGHDL-2737 . . . . .	145	VL1654PSHD-37 . . . . .	138
VL1636PSGHD-2737 . . . . .	145	VL1642PSHDR-27 . . . . .	139	VL1648PSGHDL-37 . . . . .	143	VL1654PSO-27 . . . . .	142
VL1636PSGHD-37 . . . . .	143	VL1642PSHDR-2737 . . . . .	140	VL1648PSGHDR-27 . . . . .	144	VL1654PSO-2737 . . . . .	142
VL1636PSHD-27 . . . . .	139	VL1642PSHDR-37 . . . . .	138	VL1648PSGHDR-2737 . . . . .	145	VL1654PSO-37 . . . . .	142
VL1636PSHD-2737 . . . . .	140	VL1642PSO-27 . . . . .	142	VL1648PSGHDR-37 . . . . .	143	VL1654PSSD-27 . . . . .	141
VL1636PSHD-37 . . . . .	138	VL1642PSO-2737 . . . . .	142	VL1648PSHDL-27 . . . . .	139	VL1654PSSD-2737 . . . . .	141
VL1636PSO-27 . . . . .	142	VL1642PSO-37 . . . . .	142	VL1648PSHDL-37 . . . . .	138	VL1654PSSD-37 . . . . .	141
VL1636PSO-2737 . . . . .	142	VL1642PSSD-27 . . . . .	141	VL1648PSHDR-27 . . . . .	139	VL1654SD . . . . .	112
VL1636PSO-37 . . . . .	142	VL1642PSSD-2737 . . . . .	141	VL1648PSHDR-2737 . . . . .	140	VL1654SDC . . . . .	112
VL1636PSSD-27 . . . . .	141	VL1642PSSD-37 . . . . .	141	VL1648PSHDR-37 . . . . .	138	VL1654SMOC . . . . .	114
VL1636PSSD-2737 . . . . .	141	VL1642SD . . . . .	109	VL1648PSO-27 . . . . .	142	VL1654SO . . . . .	108
VL1636PSSD-37 . . . . .	141	VL1642SDC . . . . .	112	VL1648PSO-2737 . . . . .	142	VL1654SOC . . . . .	111
VL1636SB . . . . .	171	VL1642SOCL . . . . .	111	VL1648PSO-37 . . . . .	142	VL1654WDGSO . . . . .	152
VL1636SD . . . . .	109	VL1642SOCR . . . . .	111	VL1648PSSD-27 . . . . .	141	VL1654WDGSOC . . . . .	155
VL1636SDC . . . . .	112	VL1642SOL . . . . .	108	VL1648PSSD-2737 . . . . .	141	VL1654WDSO . . . . .	151
VL1636SO . . . . .	108	VL1642SOR . . . . .	108	VL1648PSSD-37 . . . . .	141	VL1654WDSDC . . . . .	154
VL1636SOC . . . . .	112	VL1642WDGSOCL . . . . .	155	VL1648SD . . . . .	109	VL1654WDSO . . . . .	150
VL1636STD . . . . .	172	VL1642WDGSOCL . . . . .	155	VL1648SDC . . . . .	112	VL1654WDSOC . . . . .	153
VL1636WDGSO . . . . .	152	VL1642WDGSOCL . . . . .	155	VL1648SDOCL . . . . .	111	VL1654WGSO . . . . .	158
VL1636WDGSOC . . . . .	155	VL1642WDGSOCL . . . . .	155	VL1648SOCL . . . . .	111	VL1654WGSOC . . . . .	161
VL1636WDSO . . . . .	151	VL1642WDGSOCL . . . . .	155	VL1648SOCL . . . . .	111	VL1654WSD . . . . .	157
VL1636WDSDC . . . . .	154	VL1642WDGSOCL . . . . .	155	VL1648SOR . . . . .	108	VL1654WSDC . . . . .	160
VL1636WDSO . . . . .	150	VL1642WDSOCL . . . . .	153	VL1648WDGSOCL . . . . .	155	VL1654WSO . . . . .	156
VL1636WDSOC . . . . .	153	VL1642WDSOCR . . . . .	153	VL1648WDGSOCL . . . . .	155	VL1654WSOC . . . . .	159
VL1636WEAL . . . . .	98	VL1642WDSOL . . . . .	150	VL1648WDGSOCL . . . . .	155	VL1660DGSO . . . . .	104
VL1636WEAR . . . . .	98	VL1642WDSOR . . . . .	150	VL1648WDGSOCL . . . . .	155	VL1660DGSOC . . . . .	107

# Index

VL1660DSD . . . . .	103	VL1666WDSO . . . . .	150	VL1678WDSO . . . . .	150	VL1696DSD . . . . .	103
VL1660DSDC . . . . .	106	VL1666WDSOC . . . . .	153	VL1678WDSOC . . . . .	153	VL1696DSDC . . . . .	106
VL1660DSO . . . . .	102	VL1666WGSO . . . . .	158	VL1678WGSO . . . . .	158	VL1696DSO . . . . .	102
VL1660DSOC . . . . .	105	VL1666WGSOC . . . . .	161	VL1678WGSOC . . . . .	161	VL1696DSOC . . . . .	105
VL1660GSMOC . . . . .	115	VL1666WSD . . . . .	157	VL1678WSD . . . . .	157	VL1696GSMOC . . . . .	115
VL1660GSO . . . . .	110	VL1666WSDC . . . . .	160	VL1678WSDC . . . . .	160	VL1696GSO . . . . .	110
VL1660GSOC . . . . .	113	VL1666WSO . . . . .	156	VL1678WSO . . . . .	156	VL1696GSOC . . . . .	113
VL1660PSGHD-27 . . . . .	144	VL1666WSOC . . . . .	159	VL1678WSOC . . . . .	159	VL1696SD . . . . .	109
VL1660PSGHD-2737 . . . . .	145	VL1672DGSO . . . . .	104	VL1684DGSO . . . . .	104	VL1696SDC . . . . .	112
VL1660PSGHD-37 . . . . .	143	VL1672DGSOC . . . . .	107	VL1684DGSOC . . . . .	107	VL1696SMOC . . . . .	114
VL1660PSHD-27 . . . . .	139	VL1672DSD . . . . .	103	VL1684DSD . . . . .	103	VL1696SOC . . . . .	111
VL1660PSHD-2737 . . . . .	140	VL1672DSDC . . . . .	106	VL1684DSDC . . . . .	106	VL1696WDGSO . . . . .	152
VL1660PSHD-37 . . . . .	138	VL1672DSO . . . . .	102	VL1684DSO . . . . .	102	VL1696WDGSO . . . . .	152
VL1660PSO-27 . . . . .	142	VL1672DSOC . . . . .	105	VL1684DSOC . . . . .	105	VL1696WDSOC . . . . .	155
VL1660PSO-2737 . . . . .	142	VL1672GSMOC . . . . .	115	VL1684GSMOC . . . . .	115	VL1696WDSO . . . . .	150
VL1660PSO-37 . . . . .	142	VL1672GSO . . . . .	110	VL1684GSO . . . . .	110	VL1696WDSOC . . . . .	153
VL1660PSSD-27 . . . . .	141	VL1672GSOC . . . . .	113	VL1684GSOC . . . . .	113	VL1696WGSOC . . . . .	158
VL1660PSSD-2737 . . . . .	141	VL1672PSGHD-27 . . . . .	144	VL1684SD . . . . .	109	VL1696WSD . . . . .	157
VL1660SD . . . . .	109	VL1672PSGHD-2737 . . . . .	145	VL1684SDC . . . . .	112	VL1696WSDC . . . . .	160
VL1660SDC . . . . .	112	VL1672PSGHD-37 . . . . .	143	VL1684SMOC . . . . .	114	VL1696WSO . . . . .	156
VL1660SMOC . . . . .	114	VL1672PSHD-27 . . . . .	139	VL1684SO . . . . .	108	VL1696WSOC . . . . .	159
VL1660SO . . . . .	108	VL1672PSHD-2737 . . . . .	140	VL1684SOC . . . . .	111	VL1820PT . . . . .	199
VL1660SOC . . . . .	111	VL1672PSHD-37 . . . . .	138	VL1684WDGSO . . . . .	152	VL1820SK . . . . .	200
VL1660WDGSO . . . . .	152	VL1672PSO-27 . . . . .	142	VL1684WDGSO . . . . .	152	VL1824SK . . . . .	200
VL1660WDGSO . . . . .	155	VL1672PSO-2737 . . . . .	142	VL1684WDSO . . . . .	150	VL1825CD . . . . .	214
VL1660WDSO . . . . .	150	VL1672PSSD-27 . . . . .	141	VL1684WDSOC . . . . .	153	VL1825CD . . . . .	214
VL1660WDSOC . . . . .	153	VL1672PSSD-2737 . . . . .	141	VL1684WDSOC . . . . .	153	VL1825CD . . . . .	214
VL1660WDSO . . . . .	150	VL1672PSSD-37 . . . . .	141	VL1684WGSO . . . . .	158	VL1825CD . . . . .	214
VL1660WDSOC . . . . .	153	VL1672SD . . . . .	109	VL1684WGSOC . . . . .	161	VL1825CD . . . . .	214
VL1660WGSO . . . . .	158	VL1672SDC . . . . .	112	VL1684WSD . . . . .	157	VL1825CD . . . . .	214
VL1660WGSOC . . . . .	161	VL1672SDC . . . . .	112	VL1684WSDC . . . . .	160	VL1825CD . . . . .	214
VL1660WSD . . . . .	157	VL1672SMOC . . . . .	114	VL1684WSDC . . . . .	160	VL1825CD . . . . .	214
VL1660WSDC . . . . .	160	VL1672SMOC . . . . .	114	VL1684WSDC . . . . .	160	VL1825CD . . . . .	214
VL1660WSO . . . . .	156	VL1672SO . . . . .	108	VL1684WSDC . . . . .	160	VL1825CD . . . . .	214
VL1660WSOC . . . . .	159	VL1672SO . . . . .	108	VL1684WSDC . . . . .	160	VL1825CD . . . . .	214
VL1666DGSO . . . . .	104	VL1672SO . . . . .	111	VL1684WSDC . . . . .	160	VL1825CD . . . . .	214
VL1666DGSOC . . . . .	107	VL1672SOC . . . . .	111	VL1684WSDC . . . . .	160	VL1825CD . . . . .	214
VL1666DSD . . . . .	103	VL1672SOC . . . . .	111	VL1684WSDC . . . . .	160	VL1825CD . . . . .	214
VL1666DSDC . . . . .	106	VL1672WDGSO . . . . .	152	VL1684WSDC . . . . .	160	VL1825CD . . . . .	214
VL1666DSO . . . . .	102	VL1672WDGSO . . . . .	152	VL1684WSDC . . . . .	160	VL1825CD . . . . .	214
VL1666DSOC . . . . .	105	VL1672WDGSO . . . . .	152	VL1684WSDC . . . . .	160	VL1825CD . . . . .	214
VL1666GSMOC . . . . .	115	VL1672WDGSO . . . . .	152	VL1684WSDC . . . . .	160	VL1825CD . . . . .	214
VL1666GSO . . . . .	110	VL1672WDGSO . . . . .	152	VL1684WSDC . . . . .	160	VL1825CD . . . . .	214
VL1666GSOC . . . . .	113	VL1672WDGSO . . . . .	152	VL1684WSDC . . . . .	160	VL1825CD . . . . .	214
VL1666PSGHD-27 . . . . .	144	VL1672WDGSO . . . . .	152	VL1684WSDC . . . . .	160	VL1825CD . . . . .	214
VL1666PSGHD-2737 . . . . .	145	VL1672WDGSO . . . . .	152	VL1684WSDC . . . . .	160	VL1825CD . . . . .	214
VL1666PSGHD-37 . . . . .	143	VL1672WDGSO . . . . .	152	VL1684WSDC . . . . .	160	VL1825CD . . . . .	214
VL1666PSHD-27 . . . . .	139	VL1672WDGSO . . . . .	152	VL1684WSDC . . . . .	160	VL1825CD . . . . .	214
VL1666PSHD-2737 . . . . .	140	VL1672WDGSO . . . . .	152	VL1684WSDC . . . . .	160	VL1825CD . . . . .	214
VL1666PSHD-37 . . . . .	138	VL1672WDGSO . . . . .	152	VL1684WSDC . . . . .	160	VL1825CD . . . . .	214
VL1666PSO-27 . . . . .	142	VL1672WDGSO . . . . .	152	VL1684WSDC . . . . .	160	VL1825CD . . . . .	214
VL1666PSO-2737 . . . . .	142	VL1672WDGSO . . . . .	152	VL1684WSDC . . . . .	160	VL1825CD . . . . .	214
VL1666PSO-37 . . . . .	142	VL1672WDGSO . . . . .	152	VL1684WSDC . . . . .	160	VL1825CD . . . . .	214
VL1666PSSD-27 . . . . .	141	VL1672WDGSO . . . . .	152	VL1684WSDC . . . . .	160	VL1825CD . . . . .	214
VL1666PSSD-2737 . . . . .	141	VL1672WDGSO . . . . .	152	VL1684WSDC . . . . .	160	VL1825CD . . . . .	214
VL1666PSSD-37 . . . . .	141	VL1672WDGSO . . . . .	152	VL1684WSDC . . . . .	160	VL1825CD . . . . .	214
VL1666SD . . . . .	109	VL1672WDGSO . . . . .	152	VL1684WSDC . . . . .	160	VL1825CD . . . . .	214
VL1666SDC . . . . .	112	VL1672WDGSO . . . . .	152	VL1684WSDC . . . . .	160	VL1825CD . . . . .	214
VL1666SMOC . . . . .	114	VL1672WDGSO . . . . .	152	VL1684WSDC . . . . .	160	VL1825CD . . . . .	214
VL1666SO . . . . .	108	VL1672WDGSO . . . . .	152	VL1684WSDC . . . . .	160	VL1825CD . . . . .	214
VL1666SOC . . . . .	111	VL1672WDGSO . . . . .	152	VL1684WSDC . . . . .	160	VL1825CD . . . . .	214
VL1666WDGSO . . . . .	152	VL1672WDGSO . . . . .	152	VL1684WSDC . . . . .	160	VL1825CD . . . . .	214
VL1666WDGSO . . . . .	155	VL1672WDGSO . . . . .	152	VL1684WSDC . . . . .	160	VL1825CD . . . . .	214
VL1666WDSO . . . . .	150	VL1672WDGSO . . . . .	152	VL1684WSDC . . . . .	160	VL1825CD . . . . .	214
VL1666WDSOC . . . . .	153	VL1672WDGSO . . . . .	152	VL1684WSDC . . . . .	160	VL1825CD . . . . .	214
VL1666WGSO . . . . .	158	VL1672WDGSO . . . . .	152	VL1684WSDC . . . . .	160	VL1825CD . . . . .	214
VL1666WGSOC . . . . .	161	VL1672WDGSO . . . . .	152	VL1684WSDC . . . . .	160	VL1825CD . . . . .	214
VL1666WSD . . . . .	157	VL1672WDGSO . . . . .	152	VL1684WSDC . . . . .	160	VL1825CD . . . . .	214
VL1666WSDC . . . . .	160	VL1672WDGSO . . . . .	152	VL1684WSDC . . . . .	160	VL1825CD . . . . .	214
VL1666WSO . . . . .	156	VL1672WDGSO . . . . .	152	VL1684WSDC . . . . .	160	VL1825CD . . . . .	214
VL1666WSOC . . . . .	159	VL1672WDGSO . . . . .	152	VL1684WSDC . . . . .	160	VL1825CD . . . . .	214
VL1678DGSO . . . . .	104	VL1672WDGSO . . . . .	152	VL1684WSDC . . . . .	160	VL1825CD . . . . .	214
VL1678DGSOC . . . . .	107	VL1672WDGSO . . . . .	152	VL1684WSDC . . . . .	160	VL1825CD . . . . .	214
VL1678DSD . . . . .	103	VL1672WDGSO . . . . .	152	VL1684WSDC . . . . .	160	VL1825CD . . . . .	214
VL1678DSDC . . . . .	106	VL1672WDGSO . . . . .	152	VL1684WSDC . . . . .	160	VL1825CD . . . . .	214
VL1678DSO . . . . .	102	VL1672WDGSO . . . . .	152	VL1684WSDC . . . . .	160	VL1825CD . . . . .	214
VL1678DSOC . . . . .	105	VL1672WDGSO . . . . .	152	VL1684WSDC . . . . .	160	VL1825CD . . . . .	214
VL1678GSMOC . . . . .	115	VL1672WDGSO . . . . .	152	VL1684WSDC . . . . .	160	VL1825CD . . . . .	214
VL1678GSO . . . . .	110	VL1672WDGSO . . . . .	152	VL1684WSDC . . . . .	160	VL1825CD . . . . .	214
VL1678GSOC . . . . .	113	VL1672WDGSO . . . . .	152	VL1684WSDC . . . . .	160	VL1825CD . . . . .	214
VL1678SD . . . . .	109	VL1672WDGSO . . . . .	152	VL1684WSDC . . . . .	160	VL1825CD . . . . .	214
VL1678SDC . . . . .	112	VL1672WDGSO . . . . .	152	VL1684WSDC . . . . .	160	VL1825CD . . . . .	214
VL1678SMOC . . . . .	114	VL1672WDGSO . . . . .	152	VL1684WSDC . . . . .	160	VL1825CD . . . . .	214
VL1678SO . . . . .	108	VL1672WDGSO . . . . .	152	VL1684WSDC . . . . .	160	VL1825CD . . . . .	214
VL1678SOC . . . . .	111	VL1672WDGSO . . . . .	152	VL1684WSDC . . . . .	160	VL1825CD . . . . .	214
VL1678WDGSO . . . . .	152	VL1672WDGSO . . . . .	152	VL1684WSDC . . . . .	160	VL1825CD . . . . .	214
VL1678WDGSO . . . . .	155	VL1672WDGSO . . . . .	152	VL1684WSDC . . . . .	160	VL1825CD . . . . .	214
VL1678WDSO . . . . .	150	VL1672WDGSO . . . . .	152	VL1684WSDC . . . . .	160	VL1825CD . . . . .	214
VL1678WDSOC . . . . .	153	VL1672WDGSO . . . . .	152	VL1684WSDC . . . . .	160	VL1825CD . . . . .	214
VL1678WGSO . . . . .	158	VL1672WDGSO . . . . .	152	VL1684WSDC . . . . .	160	VL1825CD . . . . .	214
VL1678WGSOC . . . . .	161	VL1672WDGSO . . . . .	152	VL1684WSDC . . . . .	160	VL1825CD . . . . .	214
VL1678WSD . . . . .	157	VL1672WDGSO . . . . .	152	VL1684WSDC . . . . .	160	VL1825CD . . . . .	214
VL1678WSDC . . . . .	160	VL1672WDGSO . . . . .	152	VL1684WSDC . . . . .	160	VL1825CD . . . . .	214
VL1678WSO . . . . .	156	VL1672WDGSO . . . . .	152	VL1684WSDC . . . . .	160	VL1825CD . . . . .	214
VL1678WSOC . . . . .	159	VL1672WDGSO . . . . .	152	VL1684WSDC . . . . .	160	VL1825CD . . . . .	214
VL1684DGSO . . . . .	104	VL1672WDGSO . . . . .	152	VL1684WSDC . . . . .	160	VL1825CD . . . . .	214
VL1684DGSOC . . . . .	107	VL1672WDGSO . . . . .	152	VL1684WSDC . . . . .	160	VL1825CD . . . . .	214
VL1684DSD . . . . .	103	VL1672WDGSO . . . . .	152	VL1684WSDC . . . . .	160	VL1825CD . . . . .	214
VL1684DSDC . . . . .	106	VL1672WDGSO . . . . .	152	VL1684WSDC . . . . .	160	VL1825CD . . . . .	214
VL1684DSO . . . . .	102	VL1672WDGSO . . . . .	152	VL1684WSDC . . . . .	160	VL1825CD . . . . .	214
VL1684DSOC . . . . .	105	VL1672WDGSO . . . . .	152	VL1684WSDC . . . . .	160	VL1825CD . . . . .	214
VL1684GSMOC . . . . .	115	VL1672WDGSO . . . . .	152	VL1684WSDC . . . . .	160	VL1825CD . . . . .	214
VL1684GSO . . . . .	110	VL1672WDGSO . . . . .	152	VL1684WSDC . . . . .	160	VL1825CD . . . . .	214
VL1684GSOC . . . . .	113	VL1672WDGSO . . . . .	152	VL1684WSDC . . . . .	160	VL1825CD . . . . .	214
VL1684SD . . . . .	109	VL1672WDGSO . .					

# Index

VL2018-84FFSSTL . . . . .	211	VL2042RSHCR . . . . .	85	VL2060MLCR . . . . .	84	VL2418-57HL . . . . .	208
VL2018-84FFSSTR . . . . .	211	VL2042RSHR . . . . .	79	VL2060MLL . . . . .	78	VL2418-57HR . . . . .	208
VL2018-84FFTL . . . . .	204	VL2048EB . . . . .	86	VL2060MLR . . . . .	78	VL2418-72BBFO . . . . .	210
VL2018-84FFTR . . . . .	204	VL2048ELCR . . . . .	82	VL2060MRCR . . . . .	84	VL2418-72BBFSSTL . . . . .	212
VL2018-84HL . . . . .	208	VL2048ELCY . . . . .	83	VL2060RC . . . . .	90	VL2418-72BBFSSTR . . . . .	212
VL2018-84HR . . . . .	208	VL2048ELR . . . . .	76	VL2060RSHCR . . . . .	85	VL2418-72BBFTL . . . . .	205
VL2018-84WL . . . . .	201	VL2048ELY . . . . .	77	VL2060RSHR . . . . .	79	VL2418-72BBFTR . . . . .	205
VL2018-84WR . . . . .	201	VL2048ERCRCR . . . . .	82	VL2066KC . . . . .	89	VL2418-72FFO . . . . .	209
VL2030-30LF . . . . .	198	VL2048ERCY . . . . .	83	VL2066LC . . . . .	90	VL2418-72FFSSTL . . . . .	211
VL2030-42LF . . . . .	198	VL2048ERR . . . . .	76	VL2066LSHCR . . . . .	85	VL2418-72FFSSTR . . . . .	211
VL2030-57BBFT . . . . .	206	VL2048ERY . . . . .	77	VL2066LSHR . . . . .	79	VL2418-72FFTL . . . . .	204
VL2030-57FFT . . . . .	203	VL2048LLCR . . . . .	84	VL2066MCT . . . . .	93	VL2418-72FFTR . . . . .	204
VL2030-57LF . . . . .	198	VL2048LLR . . . . .	78	VL2066RC . . . . .	90	VL2418-72HL . . . . .	208
VL2030-57MFL . . . . .	207	VL2048LRCR . . . . .	84	VL2066RSHCR . . . . .	85	VL2418-72HR . . . . .	208
VL2030-57MFR . . . . .	207	VL2048LRR . . . . .	78	VL2066RSHR . . . . .	79	VL2418-72WL . . . . .	201
VL2030-57WL . . . . .	202	VL2048LSHCR . . . . .	85	VL2066SC . . . . .	88	VL2418-72WR . . . . .	201
VL2030-57WR . . . . .	202	VL2048LSHR . . . . .	79	VL2072BSC . . . . .	89	VL2418-84BBFO . . . . .	210
VL2030-72BBFT . . . . .	206	VL2048MCT . . . . .	93	VL2072DSC . . . . .	88	VL2418-84BBFSSTL . . . . .	212
VL2030-72FFT . . . . .	203	VL2048MLCR . . . . .	84	VL2072KC . . . . .	89	VL2418-84BBFSSTR . . . . .	212
VL2030-72MFL . . . . .	207	VL2048MLL . . . . .	78	VL2072LC . . . . .	90	VL2418-84BBFTL . . . . .	205
VL2030-72MFR . . . . .	207	VL2048MLR . . . . .	78	VL2072LFC . . . . .	88	VL2418-84BBFTR . . . . .	205
VL2030-72W . . . . .	200	VL2048MRCR . . . . .	84	VL2072LLC . . . . .	90	VL2418-84FFO . . . . .	209
VL2030-72WL . . . . .	202	VL2048RSHCR . . . . .	85	VL2072LRC . . . . .	90	VL2418-84FFSSTL . . . . .	211
VL2030-72WR . . . . .	202	VL2048RSHR . . . . .	79	VL2072LSHCR . . . . .	85	VL2418-84FFSSTR . . . . .	211
VL2030-84BBFT . . . . .	206	VL2054ELCR . . . . .	82	VL2072LSHR . . . . .	79	VL2418-84FFTL . . . . .	204
VL2030-84FFT . . . . .	203	VL2054ELCY . . . . .	83	VL2072MCT . . . . .	93	VL2418-84FFTR . . . . .	204
VL2030-84MFL . . . . .	207	VL2054ELR . . . . .	76	VL2072MLC . . . . .	91	VL2418-84HL . . . . .	208
VL2030-84MFR . . . . .	207	VL2054ELY . . . . .	77	VL2072MRC . . . . .	91	VL2418-84HR . . . . .	208
VL2030-84W . . . . .	200	VL2054ERCRCR . . . . .	82	VL2072RC . . . . .	90	VL2418-84WL . . . . .	201
VL2030-84WL . . . . .	202	VL2054ERCY . . . . .	83	VL2072RSHCR . . . . .	85	VL2418-84WR . . . . .	201
VL2030-84WR . . . . .	202	VL2054ERR . . . . .	76	VL2072RSHR . . . . .	79	VL2430-30LF . . . . .	198
VL2030MCT . . . . .	93	VL2054ERY . . . . .	77	VL2072SC . . . . .	88	VL2430-42LF . . . . .	198
VL2030SC . . . . .	88	VL2054LLCR . . . . .	84	VL2078KC . . . . .	89	VL2430-57BBFT . . . . .	206
VL2036-30LF . . . . .	198	VL2054LLR . . . . .	78	VL2078LC . . . . .	90	VL2430-57FFT . . . . .	203
VL2036-42LF . . . . .	198	VL2054LRCR . . . . .	84	VL2078LLC . . . . .	90	VL2430-57LF . . . . .	198
VL2036-57BBFT . . . . .	206	VL2054LRR . . . . .	78	VL2078LRC . . . . .	90	VL2430-57MFL . . . . .	207
VL2036-57FFT . . . . .	203	VL2054LSHCR . . . . .	85	VL2078MCT . . . . .	93	VL2430-57MFR . . . . .	207
VL2036-57LF . . . . .	198	VL2054LSHR . . . . .	79	VL2078MLC . . . . .	91	VL2430-57WL . . . . .	202
VL2036-72BBFT . . . . .	206	VL2054MCT . . . . .	93	VL2078MRC . . . . .	91	VL2430-57WR . . . . .	202
VL2036-72FFT . . . . .	203	VL2054MLCR . . . . .	84	VL2078RC . . . . .	90	VL2430-72BBFT . . . . .	206
VL2036-72W . . . . .	200	VL2054MLL . . . . .	78	VL2084KC . . . . .	89	VL2430-72FFT . . . . .	203
VL2036-84BBFT . . . . .	206	VL2054MLR . . . . .	78	VL2084LC . . . . .	90	VL2430-72MFL . . . . .	207
VL2036-84FFT . . . . .	203	VL2054MRCR . . . . .	84	VL2084LLC . . . . .	90	VL2430-72MFR . . . . .	207
VL2036-84W . . . . .	200	VL2054RSHCR . . . . .	85	VL2084LRC . . . . .	90	VL2430-72W . . . . .	200
VL2036BSC . . . . .	89	VL2054RSHR . . . . .	79	VL2084MCT . . . . .	93	VL2430-72WL . . . . .	202
VL2036EB . . . . .	86	VL2060DSC . . . . .	88	VL2084MLC . . . . .	91	VL2430-72WR . . . . .	202
VL2036LSHCR . . . . .	85	VL2060ELCR . . . . .	82	VL2084MRC . . . . .	91	VL2430-84BBFT . . . . .	206
VL2036LSHR . . . . .	79	VL2060ELCY . . . . .	83	VL2084RC . . . . .	90	VL2430-84FFT . . . . .	203
VL2036MCT . . . . .	93	VL2060ELR . . . . .	76	VL2090MCT . . . . .	93	VL2430-84MFL . . . . .	207
VL2036RSHCR . . . . .	85	VL2060ELY . . . . .	77	VL2096MCT . . . . .	93	VL2430-84MFR . . . . .	207
VL2036RSHR . . . . .	79	VL2060ERCRCR . . . . .	82	VL20EP . . . . .	99	VL2430-84W . . . . .	200
VL2036SC . . . . .	88	VL2060ERCY . . . . .	83	VL23EP . . . . .	99	VL2430-84WL . . . . .	202
VL2042EB . . . . .	86	VL2060ERR . . . . .	76	VL24102MCT . . . . .	93	VL2430-84WR . . . . .	202
VL2042ELCR . . . . .	82	VL2060ERY . . . . .	77	VL24108MCT . . . . .	93	VL2430MCT . . . . .	93
VL2042ELCY . . . . .	83	VL2060KC . . . . .	89	VL2418-57BBFO . . . . .	210	VL2430SC . . . . .	88
VL2042ELR . . . . .	76	VL2060LC . . . . .	90	VL2418-57BBFSSTL . . . . .	212	VL2436-30LF . . . . .	198
VL2042ELY . . . . .	77	VL2060LFC . . . . .	88	VL2418-57BBFSSTR . . . . .	212	VL2436-42LF . . . . .	198
VL2042ERCRCR . . . . .	82	VL2060LLCR . . . . .	84	VL2418-57BBFTL . . . . .	205	VL2436-57BBFT . . . . .	206
VL2042ERCY . . . . .	83	VL2060LLR . . . . .	78	VL2418-57BBFTR . . . . .	205	VL2436-57FFT . . . . .	203
VL2042ERR . . . . .	76	VL2060LRCR . . . . .	84	VL2418-57FFO . . . . .	209	VL2436-57LF . . . . .	198
VL2042ERY . . . . .	77	VL2060LRR . . . . .	78	VL2418-57FFSSTL . . . . .	211	VL2436-72BBFT . . . . .	206
VL2042LSHCR . . . . .	85	VL2060LRR . . . . .	78	VL2418-57FFSSTR . . . . .	211	VL2436-72FFT . . . . .	203
VL2042LSHR . . . . .	79	VL2060LSHCR . . . . .	85	VL2418-57FFTL . . . . .	204	VL2436-72W . . . . .	200
VL2042MCT . . . . .	93	VL2060LSHR . . . . .	79	VL2418-57FFTR . . . . .	204	VL2436-84BBFT . . . . .	206
		VL2060MCT . . . . .	93				

# Index

VL2436-84FFT. . . . .	203	VL2454LRR . . . . .	78	VL2472KC. . . . .	89	VL2850MA . . . . .	101
VL2436-84W . . . . .	200	VL2454LSHCR. . . . .	85	VL2472LC. . . . .	90	VL2853MA . . . . .	101
VL2436BSC . . . . .	89	VL2454LSHR . . . . .	79	VL2472LFC . . . . .	88	VL2854MA . . . . .	101
VL2436EB. . . . .	86	VL2454MCT . . . . .	93	VL2472LLC . . . . .	90	VL2855MA . . . . .	100
VL2436LSHCR. . . . .	85	VL2454MLCR . . . . .	84	VL2472LRC . . . . .	90	VL2859MA . . . . .	101
VL2436LSHR . . . . .	79	VL2454MLL . . . . .	78	VL2472LSHCR. . . . .	85	VL2860MA . . . . .	101
VL2436MCT . . . . .	93	VL2454MLR . . . . .	78	VL2472LSHR . . . . .	79	VL29EP . . . . .	99
VL2436RSHCR . . . . .	85	VL2454MRCR . . . . .	84	VL2472MCT . . . . .	93	VL3020MLF . . . . .	98
VL2436RSHR . . . . .	79	VL2454RCSHR . . . . .	80	VL2472MLC . . . . .	91	VL3020MLM. . . . .	98
VL2436SC. . . . .	88	VL2454RSHCR . . . . .	85	VL2472MRC . . . . .	91	VL3020MRM . . . . .	98
VL2440AHB-EL . . . . .	87	VL2454RSHR . . . . .	79	VL2472RRC . . . . .	90	VL3020MSC. . . . .	97
VL2440AHB-PN . . . . .	87	VL2460AHTD-CR. . . . .	66	VL2472RSHCR . . . . .	85	VL3024MLF . . . . .	98
VL2442EB. . . . .	86	VL2460AHTD-EL. . . . .	66	VL2472RSHR . . . . .	79	VL3024MLM. . . . .	98
VL2442ELCR . . . . .	82	VL2460AHTD-PN . . . . .	66	VL2472SC. . . . .	88	VL3024MRM . . . . .	98
VL2442ELCY. . . . .	83	VL2460BRET . . . . .	80	VL2472SHD. . . . .	186	VL3024MSC. . . . .	97
VL2442ELR . . . . .	76	VL2460DSC . . . . .	88	VL2472SHD . . . . .	91	VL3030BC. . . . .	196
VL2442ELY . . . . .	77	VL2460ELCR . . . . .	82	VL2478KC. . . . .	89	VL3042BC. . . . .	196
VL2442ERCR . . . . .	82	VL2460ELCY. . . . .	83	VL2478LC . . . . .	90	VL3042MCT. . . . .	92
VL2442ERCY . . . . .	83	VL2460ELR . . . . .	76	VL2478LLC . . . . .	90	VL3048BRET . . . . .	80
VL2442ERR . . . . .	76	VL2460ELY . . . . .	77	VL2478LRC . . . . .	90	VL3048MCT. . . . .	92
VL2442ERY . . . . .	77	VL2460ERCR . . . . .	82	VL2478MCT. . . . .	93	VL3054MCT. . . . .	92
VL2442LSHCR. . . . .	85	VL2460ERCY . . . . .	83	VL2478MLC . . . . .	91	VL3060AHTD-CR. . . . .	66
VL2442LSHR . . . . .	79	VL2460ERR . . . . .	76	VL2478MRC. . . . .	91	VL3060AHTD-EL. . . . .	66
VL2442MCT . . . . .	93	VL2460ERY . . . . .	77	VL2478RC. . . . .	90	VL3060AHTD-PN . . . . .	66
VL2442RSHCR . . . . .	85	VL2460KC . . . . .	89	VL2484KC. . . . .	89	VL3060BRET . . . . .	80
VL2442RSHR . . . . .	79	VL2460LC . . . . .	90	VL2484LC . . . . .	90	VL3060DD . . . . .	63
VL2446AHB-EL . . . . .	87	VL2460LCSHR. . . . .	80	VL2484LLC . . . . .	90	VL3060DDF . . . . .	64
VL2446AHB-PN . . . . .	87	VL2460LFC . . . . .	88	VL2484LRC . . . . .	90	VL3060MCT. . . . .	92
VL2448BRET . . . . .	80	VL2460LLCR . . . . .	84	VL2484BMTL . . . . .	96	VL3060SHD . . . . .	72
VL2448EB. . . . .	86	VL2460LLR . . . . .	78	VL2484MBMTR . . . . .	96	VL3060SHDF . . . . .	72
VL2448ELCR . . . . .	82	VL2460LRCR . . . . .	84	VL2484MCT. . . . .	93	VL3066AHTD-CR. . . . .	66
VL2448ELCY. . . . .	83	VL2460LRR . . . . .	78	VL2484MLC . . . . .	91	VL3066AHTD-EL. . . . .	66
VL2448ELR . . . . .	76	VL2460LSHCR. . . . .	85	VL2484MRC. . . . .	91	VL3066AHTD-PN . . . . .	66
VL2448ELY . . . . .	77	VL2460LSHR . . . . .	79	VL2484RC. . . . .	90	VL3066B . . . . .	73
VL2448ERCR . . . . .	82	VL2460MBULT. . . . .	96	VL2490MCT. . . . .	93	VL3066DD . . . . .	63
VL2448ERCY . . . . .	83	VL2460MCT . . . . .	93	VL2496MCT. . . . .	93	VL3066DDF . . . . .	64
VL2448ERR . . . . .	76	VL2460MLCR . . . . .	84	VL24EP . . . . .	99	VL3066LD. . . . .	70
VL2448ERY . . . . .	77	VL2460MLL . . . . .	78	VL2807MA . . . . .	100	VL3066LDF . . . . .	71
VL2448LLCR . . . . .	84	VL2460MLR . . . . .	78	VL2812MA . . . . .	100	VL3066MBULT. . . . .	96
VL2448LLR . . . . .	78	VL2460MRCR . . . . .	84	VL2814MA . . . . .	101	VL3066MCT. . . . .	92
VL2448LRCR . . . . .	84	VL2460RC . . . . .	90	VL2818MA . . . . .	100	VL3066RD . . . . .	70
VL2448LRR . . . . .	78	VL2460RCSHR . . . . .	80	VL2820MA . . . . .	101	VL3066RDF . . . . .	71
VL2448LSHCR. . . . .	85	VL2460RSHCR . . . . .	85	VL2821MA . . . . .	100	VL3066SHD . . . . .	72
VL2448LSHR . . . . .	79	VL2460RSHR . . . . .	79	VL2824MA . . . . .	100	VL3066SHDF . . . . .	72
VL2448MBULT. . . . .	96	VL2466AHTD-CR. . . . .	66	VL2826MA . . . . .	101	VL3066TD . . . . .	67
VL2448MCT . . . . .	93	VL2466AHTD-EL. . . . .	66	VL2827MA . . . . .	100	VL3072AHTD-CR. . . . .	66
VL2448MLCR . . . . .	84	VL2466AHTD-PN . . . . .	66	VL2828MA . . . . .	101	VL3072AHTD-EL. . . . .	66
VL2448MLL . . . . .	78	VL2466KC . . . . .	89	VL2830MA . . . . .	101	VL3072AHTD-PN . . . . .	66
VL2448MLR . . . . .	78	VL2466LC . . . . .	90	VL2831MA . . . . .	100	VL3072B . . . . .	73
VL2448MRCR . . . . .	84	VL2466LCSHR. . . . .	80	VL2832MA . . . . .	101	VL3072BC. . . . .	196
VL2448RSHCR . . . . .	85	VL2466LSHCR. . . . .	85	VL2833MA . . . . .	100	VL3072BCD . . . . .	197
VL2448RSHR . . . . .	79	VL2466LSHR . . . . .	79	VL2834MA . . . . .	101	VL3072DD . . . . .	63
VL2454ELCR . . . . .	82	VL2466MCT . . . . .	93	VL2836MA . . . . .	101	VL3072DDF . . . . .	64
VL2454ELCY. . . . .	83	VL2466RC . . . . .	90	VL2837MA . . . . .	100	VL3072FINL . . . . .	74
VL2454ELR . . . . .	76	VL2466RCSHR . . . . .	80	VL2838MA . . . . .	101	VL3072FINR. . . . .	74
VL2454ELY . . . . .	77	VL2466RSHCR . . . . .	85	VL2839MA . . . . .	100	VL3072LD. . . . .	70
VL2454ERCR . . . . .	82	VL2466RSHR . . . . .	79	VL2840MA . . . . .	101	VL3072LDF . . . . .	71
VL2454ERCY . . . . .	83	VL2466SC. . . . .	88	VL2842MA . . . . .	101	VL3072MBULT. . . . .	96
VL2454ERR . . . . .	76	VL2466SHD . . . . .	91, 186	VL2843MA . . . . .	100	VL3072MCT . . . . .	92
VL2454ERY . . . . .	77	VL2472AHTD-CR. . . . .	66	VL2844MA . . . . .	101	VL3072RCT . . . . .	74
VL2454LCSHR. . . . .	80	VL2472AHTD-EL. . . . .	66	VL2845MA . . . . .	100	VL3072RD . . . . .	70
VL2454LLCR . . . . .	84	VL2472AHTD-PN . . . . .	66	VL2847MA . . . . .	101	VL3072RDF . . . . .	71
VL2454LLR . . . . .	78	VL2472BSC . . . . .	89	VL2848MA . . . . .	101	VL3072SHD . . . . .	72
VL2454LRCR . . . . .	84	VL2472DSC . . . . .	88	VL2849MA . . . . .	100	VL3072SHDF . . . . .	72

# Index

VL3078B . . . . .	73	VL3678DDF . . . . .	64	VL4824MCT . . . . .	94	VLB1878MT . . . . .	192
VL3078FINL . . . . .	74	VL3678FINL . . . . .	74	VL4852ELCU . . . . .	81	VLB1884MT . . . . .	192
VL3078FINR . . . . .	74	VL3678FINR . . . . .	74	VL4852ERCU . . . . .	81	VLB1890MT . . . . .	192
VL3078RCT . . . . .	74	VL3678MBULT . . . . .	96	VL4866MCDT24L . . . . .	95	VLB1896MT . . . . .	192
VL3084B . . . . .	73	VL3678RCT . . . . .	74	VL4866MCDT24R . . . . .	95	VLB-18HL18BF360S . . . . .	184
VL3084BC . . . . .	196	VL3684B . . . . .	73	VL4872CBDL . . . . .	68	VLB-18OS18BF36BF . . . . .	184
VL3084BCD . . . . .	197	VL3684BC . . . . .	196	VL4872CBDLF . . . . .	68	VLB-18OS18OF36BF . . . . .	184
VL3084FINL . . . . .	74	VL3684BCD . . . . .	197	VL4872CBDR . . . . .	68	VLB24102MT . . . . .	192
VL3084FINR . . . . .	74	VL3684BD . . . . .	62	VL4872CBDRF . . . . .	68	VLB24108MT . . . . .	192
VL3084MBMTL . . . . .	96	VL3684BDF . . . . .	62	VL4872CBL . . . . .	73	VLB2418BF . . . . .	187
VL3084MBMTR . . . . .	96	VL3684DD . . . . .	63	VL4872CBR . . . . .	73	VLB2418HL . . . . .	189
VL3084RCT . . . . .	74	VL3684DDF . . . . .	64	VL4872MCBT24L . . . . .	95	VLB2418HR . . . . .	189
VL30EP . . . . .	99	VL3684FINL . . . . .	74	VL4872MCBT24R . . . . .	95	VLB2418MBF . . . . .	190
VL35EP . . . . .	99	VL3684FINR . . . . .	74	VL4872MCDT24L . . . . .	95	VLB2418MHL . . . . .	191
VL3620MBSC . . . . .	98	VL3684LBD . . . . .	69	VL4872MCDT24R . . . . .	95	VLB2418MHR . . . . .	191
VL3620MCT . . . . .	94	VL3684LBDF . . . . .	69	VL48EP . . . . .	99	VLB2418MOF . . . . .	191
VL3620MLF . . . . .	98	VL3684LD . . . . .	70	VL5420MCT . . . . .	94	VLB2418MOS . . . . .	190
VL3620MSC . . . . .	97	VL3684LDF . . . . .	71	VL5424MCT . . . . .	94	VLB2418MT . . . . .	192
VL3624MBSC . . . . .	98	VL3684MBULT . . . . .	96	VL6020MCT . . . . .	94	VLB2418OF . . . . .	188
VL3624MCT . . . . .	94	VL3684MCCT24L . . . . .	94	VL6024MCT . . . . .	94	VLB2430BF . . . . .	187
VL3624MLF . . . . .	98	VL3684MCCT24R . . . . .	94	VLB1024TSP . . . . .	96	VLB2430HD . . . . .	189
VL3624MSC . . . . .	97	VL3684RBD . . . . .	69	VLB1030TSP . . . . .	96	VLB2430MBF . . . . .	190
VL3630BC . . . . .	196	VL3684RBDF . . . . .	69	VLB1036TSP . . . . .	96	VLB2430MHD . . . . .	191
VL3636-20ECU . . . . .	81	VL3684RCT . . . . .	74	VLB1042TSP . . . . .	96	VLB2430MOF . . . . .	190
VL3636-24ECU . . . . .	81	VL3684RD . . . . .	70	VLB1048TSP . . . . .	96	VLB2430MOS . . . . .	190
VL3642BC . . . . .	196	VL3684RDF . . . . .	71	VLB18102MT . . . . .	192	VLB2430MSD . . . . .	191
VL3654MCCT24L . . . . .	94	VL3690MCCT24L . . . . .	94	VLB18108MT . . . . .	192	VLB2430MT . . . . .	192
VL3654MCCT24R . . . . .	94	VL3690MCCT24R . . . . .	94	VLB1818BF . . . . .	187	VLB2430OF . . . . .	188
VL3660MCCT24L . . . . .	94	VL3696MCCT24L . . . . .	94	VLB1818HL . . . . .	189	VLB2430OS . . . . .	188
VL3660MCCT24R . . . . .	94	VL3696MCCT24R . . . . .	94	VLB1818HR . . . . .	189	VLB2430SD . . . . .	188
VL3666MCCT24L . . . . .	94	VL36EP . . . . .	99	VLB1818MBF . . . . .	190	VLB2436BF . . . . .	187
VL3666MCCT24R . . . . .	94	VL41EP . . . . .	99	VLB1818MHL . . . . .	191	VLB2436HD . . . . .	189
VL3666MCT . . . . .	92	VL4220MCT . . . . .	94	VLB1818MHR . . . . .	191	VLB2436MBF . . . . .	190
VL3672AHTD-CR . . . . .	66	VL4224MCT . . . . .	94	VLB1818MOF . . . . .	191	VLB2436MHD . . . . .	191
VL3672AHTD-EL . . . . .	66	VL4242-20ECU . . . . .	81	VLB1818MOS . . . . .	190	VLB2436MOF . . . . .	190
VL3672AHTD-PN . . . . .	66	VL4242-24ECU . . . . .	81	VLB1818MT . . . . .	192	VLB2436MOS . . . . .	190
VL3672B . . . . .	73	VL4266MCBT24L . . . . .	95	VLB1818OF . . . . .	188	VLB2436MSD . . . . .	191
VL3672BC . . . . .	196	VL4266MCBT24R . . . . .	95	VLB1830BF . . . . .	187	VLB2436MT . . . . .	192
VL3672BCD . . . . .	197	VL4266MCDT24L . . . . .	95	VLB1830HD . . . . .	189	VLB2436OF . . . . .	188
VL3672BD . . . . .	62	VL4266MCDT24R . . . . .	95	VLB1830MBF . . . . .	190	VLB2436OS . . . . .	188
VL3672BDF . . . . .	62	VL4272BD . . . . .	62	VLB1830MHD . . . . .	191	VLB2436SD . . . . .	188
VL3672BMCT . . . . .	92	VL4272BDF . . . . .	62	VLB1830MOF . . . . .	190	VLB2448MT . . . . .	192
VL3672DD . . . . .	63	VL4272BMCT . . . . .	92	VLB1830MOS . . . . .	190	VLB2454LCSHR . . . . .	186
VL3672DDF . . . . .	64	VL4272CLD . . . . .	70	VLB1830MSD . . . . .	191	VLB2454MT . . . . .	192
VL3672FINL . . . . .	74	VL4272CLDF . . . . .	70	VLB1830MT . . . . .	192	VLB2454RCSHR . . . . .	186
VL3672FINR . . . . .	74	VL4272CRD . . . . .	70	VLB1830OF . . . . .	188	VLB2460LCSHR . . . . .	186
VL3672LBD . . . . .	69	VL4272CRDF . . . . .	70	VLB1830OS . . . . .	188	VLB2460MT . . . . .	192
VL3672LBDF . . . . .	69	VL4272LBD . . . . .	69	VLB1830SD . . . . .	188	VLB2460RCSHR . . . . .	186
VL3672LD . . . . .	70	VL4272LBDF . . . . .	69	VLB1836BF . . . . .	187	VLB2466LCSHR . . . . .	186
VL3672LDF . . . . .	71	VL4272LP . . . . .	74	VLB1836HD . . . . .	189	VLB2466LSHR . . . . .	186
VL3672MBULT . . . . .	96	VL4272MCBT24L . . . . .	95	VLB1836MBF . . . . .	190	VLB2466MT . . . . .	192
VL3672MCCT24L . . . . .	94	VL4272MCBT24R . . . . .	95	VLB1836MHD . . . . .	191	VLB2466RCSHR . . . . .	186
VL3672MCCT24R . . . . .	94	VL4272MCDT24L . . . . .	95	VLB1836MOF . . . . .	190	VLB2466RSHR . . . . .	186
VL3672MCT . . . . .	92	VL4272MCDT24R . . . . .	95	VLB1836MOS . . . . .	190	VLB2466SHBL . . . . .	186
VL3672RBD . . . . .	69	VL4272RBD . . . . .	69	VLB1836MSD . . . . .	191	VLB2466SHBR . . . . .	186
VL3672RBDF . . . . .	69	VL4272RBDF . . . . .	69	VLB1836MT . . . . .	192	VLB2472LSHR . . . . .	186
VL3672RCT . . . . .	74	VL4272RP . . . . .	74	VLB1836OF . . . . .	188	VLB2472MT . . . . .	192
VL3672RD . . . . .	70	VL4278LP . . . . .	74	VLB1836OS . . . . .	188	VLB2472RSHR . . . . .	186
VL3672RDF . . . . .	71	VL4278RP . . . . .	74	VLB1836SD . . . . .	188	VLB2472SHBL . . . . .	186
VL3672SHD . . . . .	72	VL4284LP . . . . .	74	VLB1848MT . . . . .	192	VLB2472SHBR . . . . .	186
VL3672SHDF . . . . .	72	VL4284RP . . . . .	74	VLB1854MT . . . . .	192	VLB2478MT . . . . .	192
VL3672TD . . . . .	67	VL42EP . . . . .	99	VLB1860MT . . . . .	192	VLB2484MT . . . . .	192
VL3678B . . . . .	73	VL47EP . . . . .	99	VLB1866MT . . . . .	192	VLB2490MT . . . . .	192
VL3678DD . . . . .	63	VL4820MCT . . . . .	94	VLB1872MT . . . . .	192	VLB2496MT . . . . .	192

# Index

VLB3072B . . . . .	179	VS0942ASR . . . . .	213, 403	VS1548ASR . . . . .	213, 403	VS54AR . . . . .	128, 318
VLB3072FINL . . . . .	179	VS0948ASR . . . . .	213, 403	VS1548TK . . . . .	147, 337	VS54TK . . . . .	118, 308
VLB3072FINR . . . . .	179	VS0954ASR . . . . .	213, 403	VS1554ASF . . . . .	214, 404	VS54TKA . . . . .	132, 322
VLB3072RCT . . . . .	180	VS0960ASR . . . . .	213, 403	VS1554ASR . . . . .	213, 403	VS54TKC . . . . .	122, 312
VLB3078B . . . . .	179	VS0966ASR . . . . .	213, 403	VS1554TK . . . . .	147, 337	VS54TKCA . . . . .	136, 326
VLB3078FINL . . . . .	179	VS0972ASR . . . . .	213, 403	VS1560ASF . . . . .	214, 404	VS6020WT . . . . .	164, 354
VLB3078FINR . . . . .	179	VS10242STB . . . . .	124, 314	VS1560ASR . . . . .	213, 403	VS6020WTC . . . . .	167, 357
VLB3078RCT . . . . .	180	VS1028FMP . . . . .	65, 181, 255, 371	VS1560TK . . . . .	146, 336	VS6042STB . . . . .	126, 316
VLB3084B . . . . .	179	VS102AR . . . . .	128, 318	VS1566ASF . . . . .	214, 404	VS60AR . . . . .	128, 318
VLB3084FINL . . . . .	179	VS102TK . . . . .	116, 306	VS1566ASR . . . . .	213, 403	VS60TK . . . . .	118, 308
VLB3084FINR . . . . .	179	VS102TKA . . . . .	130, 320	VS1566TK . . . . .	146, 336	VS60TKA . . . . .	132, 322
VLB3084RCT . . . . .	180	VS102TKC . . . . .	120, 310	VS1572ASF . . . . .	214, 404	VS60TKC . . . . .	122, 312
VLB-30BF30BF . . . . .	182	VS102TKCA . . . . .	134, 324	VS1572ASR . . . . .	213, 403	VS60TKCA . . . . .	136, 326
VLB-30BF30HD30OS . . . . .	185	VS1034FMP . . . . .	65, 71, 75, 181, 255, 261, 265, 371	VS1572TK . . . . .	146, 336	VS6620WT . . . . .	164, 354
VLB-30BF30OS . . . . .	182	VS1040FMP . . . . .	65, 71, 75, 181, 255, 261, 265, 371	VS1818CUSH . . . . .	195, 385	VS6620WTC . . . . .	166, 356
VLB-30BF30OS30BF . . . . .	185	VS1046FMP . . . . .	65, 75, 255, 265	VS1830CUSH . . . . .	195, 385	VS6642STB . . . . .	126, 316
VLB-30BF30SD30OS . . . . .	185	VS1052FMP . . . . .	65, 71, 75, 255, 261, 265	VS1836CUSH . . . . .	194, 384	VS66AR . . . . .	128, 318
VLB-30HD30OS . . . . .	182	VS1066FMP . . . . .	67, 257	VS1842STB . . . . .	173, 363	VS66TK . . . . .	118, 308
VLB-30OF30OF . . . . .	182	VS1072FMP . . . . .	67, 257	VS2036FPS . . . . .	94, 284	VS66TKA . . . . .	132, 322
VLB-30OF30OF30OF . . . . .	185	VS10842STB . . . . .	124, 314	VS2042FPS . . . . .	94, 284	VS66TKC . . . . .	122, 312
VLB-30OF30OS30OF . . . . .	185	VS108AR . . . . .	128, 318	VS2048FPS . . . . .	94, 284	VS66TKCA . . . . .	136, 326
VLB-30OS30BF . . . . .	182	VS108TK . . . . .	116, 306	VS20LB . . . . .	193, 383	VS7220WT . . . . .	163, 353
VLB-30OS30HD . . . . .	182	VS108TKA . . . . .	130, 320	VS2418CUSH . . . . .	194, 384	VS7220WTC . . . . .	166, 356
VLB-30OS30HD30BF . . . . .	185	VS108TKC . . . . .	120, 310	VS2430CUSH . . . . .	194, 384	VS7242STB . . . . .	125, 315
VLB-30OS30OS . . . . .	182	VS108TKCA . . . . .	134, 324	VS2436CUSH . . . . .	194, 384	VS72AR . . . . .	128, 318
VLB-30OS30OS30OS . . . . .	185	VS10LB . . . . .	193, 383	VS28LEG2 . . . . .	92, 282	VS72TK . . . . .	117, 307
VLB-30OS30SD . . . . .	183	VS1224ASF . . . . .	214, 404	VS28LEGC2 . . . . .	92, 282	VS72TKA . . . . .	131, 321
VLB-30OS30SD30BF . . . . .	185	VS1224ASR . . . . .	213, 403	VS3020WT . . . . .	165, 355	VS72TKC . . . . .	121, 311
VLB-30SD30OS . . . . .	183	VS1228FTS . . . . .	178, 368	VS3020WTC . . . . .	168, 358	VS72TKCA . . . . .	135, 325
VLB-30SD30SD . . . . .	183	VS1230ASF . . . . .	214, 404	VS3042STB . . . . .	127, 173, 317, 363	VS7820WT . . . . .	163, 353
VLB3672B . . . . .	179	VS1230ASR . . . . .	213, 403	VS30AR . . . . .	128, 318	VS7820WTC . . . . .	166, 356
VLB3672FINL . . . . .	179	VS1234FTS . . . . .	178, 368	VS30TK . . . . .	119, 309	VS7842STB . . . . .	125, 315
VLB3672FINR . . . . .	179	VS1236ASF . . . . .	214, 404	VS30TKA . . . . .	133, 323	VS78AR . . . . .	128, 318
VLB3672RCT . . . . .	180	VS1236ASR . . . . .	213, 403	VS30TKC . . . . .	123, 313	VS78TK . . . . .	117, 307
VLB3678B . . . . .	179	VS1240FTS . . . . .	178, 368	VS30TKCA . . . . .	137, 327	VS78TKA . . . . .	131, 321
VLB3678FINL . . . . .	179	VS1242ASF . . . . .	214, 404	VS3620WT . . . . .	165, 355	VS78TKC . . . . .	121, 311
VLB3678FINR . . . . .	179	VS1242ASR . . . . .	213, 403	VS3620WTC . . . . .	168, 358	VS78TKCA . . . . .	135, 325
VLB3678RCT . . . . .	180	VS1248ASF . . . . .	214, 404	VS3642STB . . . . .	127, 173, 317, 363	VS8420WT . . . . .	163, 353
VLB3684B . . . . .	179	VS1248ASR . . . . .	213, 403	VS36AR . . . . .	128, 318	VS8420WTC . . . . .	166, 356
VLB3684FINL . . . . .	179	VS1254ASF . . . . .	214, 404	VS36TK . . . . .	119, 309	VS8442STB . . . . .	125, 315
VLB3684FINR . . . . .	179	VS1254ASR . . . . .	213, 403	VS36TKA . . . . .	133, 323	VS84AR . . . . .	128, 318
VLB3684RCT . . . . .	180	VS1260ASF . . . . .	214, 404	VS36TKC . . . . .	123, 313	VS84TK . . . . .	117, 307
VLB-36BF18BF18OS . . . . .	184	VS1260ASR . . . . .	213, 403	VS36TKCA . . . . .	137, 327	VS84TKA . . . . .	131, 321
VLB-36BF18OF18OS . . . . .	184	VS1266ASF . . . . .	214, 404	VS4220WT . . . . .	165, 355	VS84TKC . . . . .	121, 311
VLB-36BF36BF . . . . .	182	VS1266ASR . . . . .	213, 403	VS4220WTC . . . . .	168, 358	VS84TKCA . . . . .	135, 325
VLB-36BF36OS . . . . .	182	VS1272ASF . . . . .	214, 404	VS4242STB . . . . .	127, 317	VS9042STB . . . . .	124, 314
VLB-36HD36OS . . . . .	182	VS1272ASR . . . . .	213, 403	VS42AR . . . . .	128, 318	VS90AR . . . . .	128, 318
VLB-36OF36OF . . . . .	182	VS1524ASF . . . . .	214, 404	VS42TK . . . . .	119, 309	VS90TK . . . . .	116, 306
VLB-36OS18BF18HR . . . . .	184	VS1524ASR . . . . .	213, 403	VS42TKA . . . . .	133, 323	VS90TKA . . . . .	130, 320
VLB-36OS36BF . . . . .	182	VS1530ASF . . . . .	214, 404	VS42TKC . . . . .	123, 313	VS90TKC . . . . .	120, 310
VLB-36OS36HD . . . . .	182	VS1530ASR . . . . .	213, 403	VS42TKCA . . . . .	137, 327	VS90TKCA . . . . .	134, 324
VLB-36OS36OS . . . . .	182	VS1530TK . . . . .	148, 338	VS4820WT . . . . .	164, 354	VS9642STB . . . . .	124, 314
VLB-36OS36SD . . . . .	183	VS1536ASF . . . . .	214, 404	VS4820WTC . . . . .	167, 357	VS96AR . . . . .	128, 318
VLB-36SD36OS . . . . .	183	VS1542ASF . . . . .	214, 404	VS4842STB . . . . .	126, 316	VS96TK . . . . .	116, 306
VLB-36SD36SD . . . . .	183	VS1542ASR . . . . .	213, 403	VS48AR . . . . .	128, 318	VS96TKA . . . . .	130, 320
VLB4272LP . . . . .	180	VS1542TK . . . . .	147, 337	VS48TK . . . . .	118, 308	VS96TKC . . . . .	120, 310
VLB4272RP . . . . .	180	VS1548ASF . . . . .	214, 404	VS48TKA . . . . .	132, 322	VS96TKCA . . . . .	134, 324
VLB4278LP . . . . .	180	VS0924ASR . . . . .	213, 403	VS48TKC . . . . .	122, 312	VS-LBRKT-20 . . . . .	92, 282
VLB4278RP . . . . .	180	VS0930ASR . . . . .	213, 403	VS48TKCA . . . . .	136, 326	VS-LBRKT-24 . . . . .	92, 282
VLB4284LP . . . . .	180	VS0936ASR . . . . .	213, 403	VS5420WT . . . . .	164, 354	VS-LBRKT-30 . . . . .	92, 282
VLB4284RP . . . . .	180			VS5420WTC . . . . .	167, 357	VS0940TDM . . . . .	277
VS0924ASR . . . . .	213, 403			VS5442STB . . . . .	126, 316	VS0946TDM . . . . .	277
VS0930ASR . . . . .	213, 403					VS0952TDM . . . . .	257
VS0936ASR . . . . .	213, 403					VS0958TDM . . . . .	257

# Index

WV0964TDM . . . . .	257	WV1554DWO . . . . .	339	WV1618DSTDL . . . . .	360	WV1630WDGSOC . . . . .	345
WV10102WCU . . . . .	352	WV1554WDTS . . . . .	339	WV1618DSTDR . . . . .	360	WV1630WDS . . . . .	341
WV10108WCU . . . . .	352	WV1554WOO . . . . .	346	WV1618GSBL . . . . .	361	WV1630WDSDC . . . . .	344
WV1024TSP . . . . .	286	WV1554WTS . . . . .	346	WV1618GSBR . . . . .	361	WV1630WDSO . . . . .	340
WV1030TSP . . . . .	286	WV16102DGSO . . . . .	294	WV1618GSTDL . . . . .	362	WV1630WDSOC . . . . .	343
WV1030WCU . . . . .	352	WV16102DGSOC . . . . .	297	WV1618GSTDR . . . . .	362	WV1630WEAL . . . . .	288
WV1036TSP . . . . .	286	WV16102DSD . . . . .	293	WV1618SBL . . . . .	361	WV1630WEAR . . . . .	288
WV1036WCU . . . . .	352	WV16102DSDC . . . . .	296	WV1618SBR . . . . .	361	WV1630WGSO . . . . .	348
WV1042TSP . . . . .	286	WV16102DSO . . . . .	292	WV1618STDL . . . . .	362	WV1630WGSOC . . . . .	351
WV1042WCU . . . . .	352	WV16102DSOC . . . . .	295	WV1618STDR . . . . .	362	WV1630WSD . . . . .	347
WV1048TSP . . . . .	286	WV16102GSMOC . . . . .	305	WV1620MBBF . . . . .	287	WV1630WSDC . . . . .	350
WV1048WCU . . . . .	352	WV16102GSO . . . . .	300	WV1620MFF . . . . .	287	WV1630WSO . . . . .	346
WV1054WCU . . . . .	352	WV16102GSOC . . . . .	303	WV1620MP . . . . .	389	WV1630WSOC . . . . .	349
WV1060WCU . . . . .	352	WV16102SD . . . . .	299	WV1620SK . . . . .	391	WV1636BMS . . . . .	366
WV1066WCU . . . . .	352	WV16102SDC . . . . .	302	WV1620WEAL . . . . .	288	WV1636BMSSD . . . . .	366
WV1072WCU . . . . .	352	WV16102SMOC . . . . .	304	WV1620WEAR . . . . .	288	WV1636BO . . . . .	360
WV1078WCU . . . . .	352	WV16102SO . . . . .	298	WV1624MBBF . . . . .	287	WV1636DBMS . . . . .	364
WV1084WCU . . . . .	352	WV16102SOC . . . . .	301	WV1624MFF . . . . .	287	WV1636DBMSSD . . . . .	364
WV1090WCU . . . . .	352	WV16102WDGSO . . . . .	342	WV1624SK . . . . .	391	WV1636DBO . . . . .	358
WV1096WCU . . . . .	352	WV16102WDGSOC . . . . .	345	WV1624WEAL . . . . .	288	WV1636DGBMS . . . . .	365
WV12SP . . . . .	290	WV16102WDS . . . . .	341	WV1624WEAR . . . . .	288	WV1636DGSB . . . . .	359
WV1366TC . . . . .	368	WV16102WDSDC . . . . .	344	WV1630BMS . . . . .	366	WV1636DGSO . . . . .	294
WV1372TC . . . . .	368	WV16102WDSO . . . . .	340	WV1630BMSSD . . . . .	366	WV1636DGSOC . . . . .	298
WV1428TS . . . . .	368	WV16102WDSOC . . . . .	343	WV1630BO . . . . .	360	WV1636DGSTD . . . . .	360
WV1434TS . . . . .	368	WV16102WGSO . . . . .	348	WV1630DBMS . . . . .	364	WV1636DSB . . . . .	359
WV1440TS . . . . .	368	WV16102WGSOC . . . . .	351	WV1630DBMSSD . . . . .	364	WV1636DSD . . . . .	293
WV1520SK . . . . .	390	WV16102WSD . . . . .	347	WV1630DBO . . . . .	358	WV1636SDC . . . . .	296
WV1524SK . . . . .	390	WV16102WSDC . . . . .	350	WV1630DGBMS . . . . .	365	WV1636SDS . . . . .	292
WV1530B00 . . . . .	366	WV16102WSO . . . . .	346	WV1630DGSB . . . . .	359	WV1636DSOC . . . . .	296
WV1530BTS . . . . .	366	WV16102WSOC . . . . .	349	WV1630DGSO . . . . .	294	WV1636DSTD . . . . .	360
WV1530DB00 . . . . .	364	WV16108DGSO . . . . .	294	WV1630DGSOC . . . . .	298	WV1636GBMS . . . . .	367
WV1530DBTS . . . . .	364	WV16108DGSOC . . . . .	297	WV1630DGSTD . . . . .	360	WV1636GSB . . . . .	361
WV1530DWOO . . . . .	339	WV16108DSD . . . . .	293	WV1630DGS . . . . .	359	WV1636GSO . . . . .	300
WV1530WDTS . . . . .	339	WV16108SDC . . . . .	296	WV1630DSB . . . . .	359	WV1636GSOC . . . . .	304
WV1530WOO . . . . .	346	WV16108SDS . . . . .	292	WV1630DSD . . . . .	293	WV1636GSTD . . . . .	362
WV1530WTS . . . . .	346	WV16108SOC . . . . .	295	WV1630SDC . . . . .	296	WV1636GGSTD . . . . .	362
WV1536B00 . . . . .	366	WV16108DSOC . . . . .	295	WV1630DSO . . . . .	292	WV1636MFF . . . . .	287
WV1536BTS . . . . .	366	WV16108GSMOC . . . . .	305	WV1630DSOC . . . . .	296	WV1636MFF . . . . .	287
WV1536DB00 . . . . .	364	WV16108GSO . . . . .	300	WV1630DSTD . . . . .	360	WV1636PSGHD-27 . . . . .	334
WV1536DBTS . . . . .	364	WV16108GSOC . . . . .	303	WV1630DST . . . . .	360	WV1636PSGHD-2737 . . . . .	335
WV1536DWOO . . . . .	339	WV16108SD . . . . .	299	WV1630GBMS . . . . .	367	WV1636PSGHD-37 . . . . .	333
WV1536WDTS . . . . .	339	WV16108SDC . . . . .	302	WV1630GSB . . . . .	361	WV1636PSHD-27 . . . . .	329
WV1536WOO . . . . .	346	WV16108SDS . . . . .	302	WV1630GSO . . . . .	300	WV1636PSHD-2737 . . . . .	330
WV1536WTS . . . . .	346	WV16108SMOC . . . . .	304	WV1630GSOC . . . . .	304	WV1636PSHD-37 . . . . .	328
WV1542B00 . . . . .	366	WV16108SO . . . . .	298	WV1630GSTD . . . . .	362	WV1636PSO-27 . . . . .	332
WV1542BTS . . . . .	366	WV16108SOC . . . . .	301	WV1630MFF . . . . .	287	WV1636PSO-2737 . . . . .	332
WV1542DB00 . . . . .	364	WV16108WDGSO . . . . .	342	WV1630MFF . . . . .	287	WV1636PSO-37 . . . . .	332
WV1542DBTS . . . . .	364	WV16108WDGSOC . . . . .	345	WV1630MFF . . . . .	287	WV1636PSSD-27 . . . . .	331
WV1542DWOO . . . . .	339	WV16108WDS . . . . .	341	WV1630MFF . . . . .	287	WV1636PSSD-2737 . . . . .	331
WV1542WDTS . . . . .	339	WV16108WDSDC . . . . .	344	WV1630MFF . . . . .	287	WV1636SB . . . . .	361
WV1542WOO . . . . .	346	WV16108WDSO . . . . .	340	WV1630MFF . . . . .	287	WV1636SD . . . . .	299
WV1542WTS . . . . .	346	WV16108WDSOC . . . . .	343	WV1630MFF . . . . .	287	WV1636SDC . . . . .	302
WV1548B00 . . . . .	366	WV16108WGSO . . . . .	348	WV1630MFF . . . . .	287	WV1636SO . . . . .	298
WV1548BTS . . . . .	366	WV16108WGSOC . . . . .	351	WV1630MFF . . . . .	287	WV1636SOC . . . . .	302
WV1548DB00 . . . . .	364	WV16108WSD . . . . .	347	WV1630MFF . . . . .	287	WV1636STD . . . . .	362
WV1548DBTS . . . . .	364	WV16108WSDC . . . . .	350	WV1630MFF . . . . .	287	WV1636WDGSO . . . . .	342
WV1548DWOO . . . . .	339	WV16108WSO . . . . .	346	WV1630MFF . . . . .	287	WV1636WDGSOC . . . . .	345
WV1548WDTS . . . . .	339	WV16108WSOC . . . . .	349	WV1630MFF . . . . .	287	WV1636WDS . . . . .	341
WV1548WOO . . . . .	346	WV1618BO . . . . .	360	WV1630MFF . . . . .	287	WV1636WDSDC . . . . .	344
WV1548WTS . . . . .	346	WV1618DBO . . . . .	358	WV1630MFF . . . . .	287	WV1636WDSO . . . . .	340
WV1554B00 . . . . .	366	WV1618DGSBL . . . . .	359	WV1630MFF . . . . .	287	WV1636WDSOC . . . . .	343
WV1554BTS . . . . .	366	WV1618DGSBR . . . . .	359	WV1630MFF . . . . .	287	WV1636WEAL . . . . .	288
WV1554DB00 . . . . .	364	WV1618DGSSTDL . . . . .	360	WV1630MFF . . . . .	287	WV1636WEAR . . . . .	288
WV1554DBTS . . . . .	364	WV1618DGSTDR . . . . .	360	WV1630MFF . . . . .	287	WV1636WGSO . . . . .	348
		WV1618DSBL . . . . .	359				
		WV1618DSBR . . . . .	359				





# Index

WV1666WSDSD . . . . .	344	WV1678WSDSD . . . . .	344	WV1696DSD . . . . .	296	WV2018-84FFSSTR . . . . .	401
WV1666WDSO . . . . .	340	WV1678WDSO . . . . .	340	WV1696DSO . . . . .	292	WV2018-84FFTL . . . . .	394
WV1666WDSOC . . . . .	343	WV1678WDSOC . . . . .	343	WV1696DSOC . . . . .	295	WV2018-84FFTR . . . . .	394
WV1666WGSO . . . . .	348	WV1678WGSO . . . . .	348	WV1696GSMOC . . . . .	305	WV2018-84HL . . . . .	398
WV1666WGSOC . . . . .	351	WV1678WGSOC . . . . .	351	WV1696GSO . . . . .	300	WV2018-84HR . . . . .	398
WV1666WSD . . . . .	347	WV1678WSD . . . . .	347	WV1696GSOC . . . . .	303	WV2018-84WL . . . . .	391
WV1666WSDC . . . . .	350	WV1678WSDC . . . . .	350	WV1696SD . . . . .	299	WV2018-84WR . . . . .	391
WV1666WSO . . . . .	346	WV1678WSO . . . . .	346	WV1696SDC . . . . .	302	WV2030-30LF . . . . .	388
WV1666WSOC . . . . .	349	WV1678WSOC . . . . .	349	WV1696SMOC . . . . .	304	WV2030-42LF . . . . .	388
WV1672DGSO . . . . .	294	WV1684DGSO . . . . .	294	WV1696SO . . . . .	298	WV2030-57BBFT . . . . .	396
WV1672DGSOC . . . . .	297	WV1684DGSOC . . . . .	297	WV1696SOC . . . . .	301	WV2030-57FFT . . . . .	393
WV1672DSD . . . . .	293	WV1684DSD . . . . .	293	WV1696WDGSO . . . . .	342	WV2030-57LF . . . . .	388
WV1672DSDC . . . . .	296	WV1684DSDC . . . . .	296	WV1696WDGSOC . . . . .	345	WV2030-57MFL . . . . .	397
WV1672DSO . . . . .	292	WV1684DSO . . . . .	292	WV1696WDSO . . . . .	341	WV2030-57MFR . . . . .	397
WV1672DSOC . . . . .	295	WV1684DSOC . . . . .	295	WV1696WDSDC . . . . .	344	WV2030-57WL . . . . .	392
WV1672GSMOC . . . . .	305	WV1684GSMOC . . . . .	305	WV1696WDSO . . . . .	340	WV2030-57WR . . . . .	392
WV1672GSO . . . . .	300	WV1684GSO . . . . .	300	WV1696WDSOC . . . . .	343	WV2030-72BBFT . . . . .	396
WV1672GSOC . . . . .	303	WV1684GSOC . . . . .	303	WV1696WGSO . . . . .	348	WV2030-72FFT . . . . .	393
WV1672PSGHD-27 . . . . .	334	WV1684SD . . . . .	299	WV1696WGSOC . . . . .	351	WV2030-72MFL . . . . .	397
WV1672PSGHD-2737 . . . . .	335	WV1684SDC . . . . .	302	WV1696WSD . . . . .	347	WV2030-72MFR . . . . .	397
WV1672PSGHD-37 . . . . .	333	WV1684SMOC . . . . .	304	WV1696WSDC . . . . .	350	WV2030-72W . . . . .	390
WV1672PSHD-27 . . . . .	329	WV1684SO . . . . .	298	WV1696WSO . . . . .	346	WV2030-72WL . . . . .	392
WV1672PSHD-2737 . . . . .	330	WV1684SOC . . . . .	301	WV1696WSOC . . . . .	349	WV2030-72WR . . . . .	392
WV1672PSHD-37 . . . . .	328	WV1684WDGSO . . . . .	342	WV1820PT . . . . .	389	WV2030-84BBFT . . . . .	396
WV1672PSO-27 . . . . .	332	WV1684WDGSOC . . . . .	345	WV1820SK . . . . .	390	WV2030-84FFT . . . . .	393
WV1672PSO-2737 . . . . .	332	WV1684WDSO . . . . .	341	WV1824SK . . . . .	390	WV2030-84MFL . . . . .	397
WV1672PSO-37 . . . . .	332	WV1684WSDC . . . . .	344	WV1825CD . . . . .	404	WV2030-84MFR . . . . .	397
WV1672PSSD-27 . . . . .	331	WV1684WSDO . . . . .	340	WV19EP . . . . .	289	WV2030-84W . . . . .	390
WV1672PSSD-2737 . . . . .	331	WV1684WDSOC . . . . .	343	WV20102MCT . . . . .	283	WV2030-84WL . . . . .	392
WV1672PSSD-37 . . . . .	331	WV1684WGSO . . . . .	348	WV20108MCT . . . . .	283	WV2030-84WR . . . . .	392
WV1672SD . . . . .	299	WV1684WGSOC . . . . .	351	WV2016ST . . . . .	368	WV2030MCT . . . . .	283
WV1672SDC . . . . .	302	WV1684WSD . . . . .	347	WV2018-57BBFO . . . . .	400	WV2030SC . . . . .	278
WV1672SMOC . . . . .	304	WV1684WSDC . . . . .	350	WV2018-57BBFSSTL . . . . .	402	WV2036-30LF . . . . .	388
WV1672SO . . . . .	298	WV1684WSO . . . . .	346	WV2018-57BBFSSTR . . . . .	402	WV2036-42LF . . . . .	388
WV1672SOC . . . . .	301	WV1684WSOC . . . . .	349	WV2018-57BBFTL . . . . .	395	WV2036-57BBFT . . . . .	396
WV1672WDGSO . . . . .	342	WV1690DGSO . . . . .	294	WV2018-57BBFTR . . . . .	395	WV2036-57FFT . . . . .	393
WV1672WDGSOC . . . . .	345	WV1690DGSOC . . . . .	297	WV2018-57FFO . . . . .	399	WV2036-57LF . . . . .	388
WV1672WDSO . . . . .	341	WV1690DSD . . . . .	293	WV2018-57FFSSTL . . . . .	401	WV2036-72BBFT . . . . .	396
WV1672WSDC . . . . .	344	WV1690DSDC . . . . .	296	WV2018-57FFSSTR . . . . .	401	WV2036-72FFT . . . . .	393
WV1672WDSO . . . . .	340	WV1690DSO . . . . .	292	WV2018-57FFTL . . . . .	394	WV2036-72W . . . . .	390
WV1672WDSOC . . . . .	343	WV1690DSOC . . . . .	295	WV2018-57FFTR . . . . .	394	WV2036-84BBFT . . . . .	396
WV1672WGSO . . . . .	348	WV1690GSMOC . . . . .	305	WV2018-57HL . . . . .	398	WV2036-84FFT . . . . .	393
WV1672WGSOC . . . . .	351	WV1690GSO . . . . .	300	WV2018-57HR . . . . .	398	WV2036-84W . . . . .	390
WV1672WSD . . . . .	347	WV1690GSOC . . . . .	303	WV2018-72BBFO . . . . .	400	WV2036BSC . . . . .	279
WV1672WSDC . . . . .	350	WV1690SD . . . . .	299	WV2018-72BBFSSTL . . . . .	402	WV2036EB . . . . .	276
WV1672WSO . . . . .	346	WV1690SDC . . . . .	302	WV2018-72BBFSSTR . . . . .	402	WV2036LSHCR . . . . .	275
WV1672WSOC . . . . .	349	WV1690SMOC . . . . .	304	WV2018-72BBFTL . . . . .	395	WV2036LSHR . . . . .	269
WV1678DGSO . . . . .	294	WV1690SO . . . . .	298	WV2018-72BBFTR . . . . .	395	WV2036MCT . . . . .	283
WV1678DGSOC . . . . .	297	WV1690SOC . . . . .	301	WV2018-72FFO . . . . .	399	WV2036RSHCR . . . . .	275
WV1678DSD . . . . .	293	WV1690WDGSO . . . . .	342	WV2018-72FFSSTL . . . . .	401	WV2036RSHR . . . . .	269
WV1678DSDC . . . . .	296	WV1690WDGSOC . . . . .	345	WV2018-72FFSSTR . . . . .	401	WV2036SC . . . . .	278
WV1678DSO . . . . .	292	WV1690WDSO . . . . .	341	WV2018-72FFTL . . . . .	394	WV2042EB . . . . .	276
WV1678DSOC . . . . .	295	WV1690WDSOC . . . . .	344	WV2018-72FFTR . . . . .	394	WV2042ELCR . . . . .	272
WV1678GSMOC . . . . .	305	WV1690WDSO . . . . .	340	WV2018-72HL . . . . .	398	WV2042ELCY . . . . .	273
WV1678GSO . . . . .	300	WV1690WDSOC . . . . .	343	WV2018-72HR . . . . .	398	WV2042ELR . . . . .	266
WV1678GSOC . . . . .	303	WV1690WGSO . . . . .	348	WV2018-72WL . . . . .	391	WV2042ELY . . . . .	267
WV1678SD . . . . .	299	WV1690WGSOC . . . . .	351	WV2018-72WR . . . . .	391	WV2042ERCR . . . . .	272
WV1678SDC . . . . .	302	WV1690WSD . . . . .	347	WV2018-84BBFO . . . . .	400	WV2042ERCY . . . . .	273
WV1678SMOC . . . . .	304	WV1690WSDC . . . . .	350	WV2018-84BBFSSTL . . . . .	402	WV2042ERR . . . . .	266
WV1678SO . . . . .	298	WV1690WSO . . . . .	346	WV2018-84BBFSSTR . . . . .	402	WV2042ERY . . . . .	267
WV1678SOC . . . . .	301	WV1690WSOC . . . . .	349	WV2018-84BBFTL . . . . .	395	WV2042LSHCR . . . . .	275
WV1678WDGSO . . . . .	342	WV1696DGSO . . . . .	294	WV2018-84BBFTR . . . . .	395	WV2042LSHR . . . . .	269
WV1678WDGSOC . . . . .	345	WV1696DGSOC . . . . .	297	WV2018-84FFO . . . . .	399	WV2042MCT . . . . .	283
WV1678WDSO . . . . .	341	WV1696DSD . . . . .	293	WV2018-84FFSSTL . . . . .	401	WV2042RSHCR . . . . .	275

# Index

WV2042RSHR . . . . .	269	WV2060MLL . . . . .	268	WV2418-57HR. . . . .	398	WV2436-84W . . . . .	390
WV2048EB. . . . .	276	WV2060MLR . . . . .	268	WV2418-72BBFO . . . . .	400	WV2436BSC . . . . .	279
WV2048ELCR . . . . .	272	WV2060MRCR . . . . .	274	WV2418-72BBFSSTL. . . . .	402	WV2436EB. . . . .	276
WV2048ELCY . . . . .	273	WV2060RC . . . . .	280	WV2418-72BBFSSTR. . . . .	402	WV2436LSHCR. . . . .	275
WV2048ELR . . . . .	266	WV2060RSHCR . . . . .	275	WV2418-72BBFTL . . . . .	395	WV2436LSHR . . . . .	269
WV2048ELY . . . . .	267	WV2060RSHR . . . . .	269	WV2418-72BBFTR . . . . .	395	WV2436MCT. . . . .	283
WV2048ERCR . . . . .	272	WV2066KC . . . . .	279	WV2418-72FFO . . . . .	399	WV2436RSHCR . . . . .	275
WV2048ERCY . . . . .	273	WV2066LC. . . . .	280	WV2418-72FFSSTL. . . . .	401	WV2436RSHR . . . . .	269
WV2048ERR . . . . .	266	WV2066LSHCR. . . . .	275	WV2418-72FFSSTR . . . . .	401	WV2436SC . . . . .	278
WV2048ERY . . . . .	267	WV2066LSHR . . . . .	269	WV2418-72FFTL . . . . .	394	WV2440AHB-EL . . . . .	277
WV2048LLCR . . . . .	274	WV2066MCT. . . . .	283	WV2418-72FFTR . . . . .	394	WV2440AHB-PN . . . . .	277
WV2048LLR . . . . .	268	WV2066RC . . . . .	280	WV2418-72HL . . . . .	398	WV2442EB. . . . .	276
WV2048LRCR . . . . .	274	WV2066RSHCR . . . . .	275	WV2418-72HR. . . . .	398	WV2442ELCR . . . . .	272
WV2048LRR . . . . .	268	WV2066RSHR . . . . .	269	WV2418-72WL . . . . .	391	WV2442ELCY . . . . .	273
WV2048LSHCR. . . . .	275	WV2066SC . . . . .	278	WV2418-72WR . . . . .	391	WV2442ELR . . . . .	266
WV2048LSHR . . . . .	269	WV2072BSC . . . . .	279	WV2418-84BBFO . . . . .	400	WV2442ELY . . . . .	267
WV2048MCT. . . . .	283	WV2072DSC . . . . .	278	WV2418-84BBFSSTL. . . . .	402	WV2442ERCR . . . . .	272
WV2048MLCR . . . . .	274	WV2072KC . . . . .	279	WV2418-84BBFSSTR. . . . .	402	WV2442ERCY . . . . .	273
WV2048MLL . . . . .	268	WV2072LC. . . . .	280	WV2418-84BBFTL . . . . .	395	WV2442ERR . . . . .	266
WV2048MLR. . . . .	268	WV2072LFC . . . . .	278	WV2418-84BBFTR . . . . .	395	WV2442ERY . . . . .	267
WV2048MRCR . . . . .	274	WV2072LLC . . . . .	280	WV2418-84FFO . . . . .	399	WV2442LSHCR. . . . .	275
WV2048RSHCR . . . . .	275	WV2072LRC . . . . .	280	WV2418-84FFSSTL. . . . .	401	WV2442LSHR . . . . .	269
WV2048RSHR . . . . .	269	WV2072LSHCR. . . . .	275	WV2418-84FFSSTR . . . . .	401	WV2442MCT. . . . .	283
WV2054ELCR . . . . .	272	WV2072LSHR . . . . .	269	WV2418-84FFTL . . . . .	394	WV2442RSHCR . . . . .	275
WV2054ELCY . . . . .	273	WV2072MCT. . . . .	283	WV2418-84FFTR . . . . .	394	WV2442RSHR . . . . .	269
WV2054ELR . . . . .	266	WV2072MLC . . . . .	281	WV2418-84HL . . . . .	398	WV2446AHB-EL . . . . .	277
WV2054ELY . . . . .	267	WV2072MRC. . . . .	281	WV2418-84HR. . . . .	398	WV2446AHB-PN . . . . .	277
WV2054ERCR . . . . .	272	WV2072RC . . . . .	280	WV2418-84WL . . . . .	391	WV2448BRET . . . . .	270
WV2054ERCY . . . . .	273	WV2072RSHCR . . . . .	275	WV2418-84WR . . . . .	391	WV2448EB. . . . .	276
WV2054ERR . . . . .	266	WV2072RSHR . . . . .	269	WV2430-30LF . . . . .	388	WV2448ELCR . . . . .	272
WV2054ERY . . . . .	267	WV2072SC . . . . .	278	WV2430-42LF . . . . .	388	WV2448ELCY . . . . .	273
WV2054LLCR . . . . .	274	WV2078KC . . . . .	279	WV2430-57BBFT. . . . .	396	WV2448ELR . . . . .	266
WV2054LLR . . . . .	268	WV2078LC. . . . .	280	WV2430-57FFT . . . . .	393	WV2448ELY . . . . .	267
WV2054LRCR . . . . .	274	WV2078LLC . . . . .	280	WV2430-57LF . . . . .	388	WV2448ERCR . . . . .	272
WV2054LRR . . . . .	268	WV2078LRC . . . . .	280	WV2430-57MFL . . . . .	397	WV2448ERCY . . . . .	273
WV2054LSHCR. . . . .	275	WV2078MCT. . . . .	283	WV2430-57MFR . . . . .	397	WV2448ERR . . . . .	266
WV2054LSHR . . . . .	269	WV2078MLC . . . . .	281	WV2430-57WL . . . . .	392	WV2448ERY . . . . .	267
WV2054MCT. . . . .	283	WV2078MRC. . . . .	281	WV2430-57WR . . . . .	392	WV2448LLCR . . . . .	274
WV2054MLCR . . . . .	274	WV2078RC . . . . .	280	WV2430-72BBFT. . . . .	396	WV2448LLR . . . . .	268
WV2054MLL . . . . .	268	WV2084KC . . . . .	279	WV2430-72FFT . . . . .	393	WV2448LRCR . . . . .	274
WV2054MLR. . . . .	268	WV2084LC. . . . .	280	WV2430-72MFL . . . . .	397	WV2448LRR . . . . .	268
WV2054MRCR . . . . .	274	WV2084LLC . . . . .	280	WV2430-72MFR . . . . .	397	WV2448LSHCR. . . . .	275
WV2054RSHCR . . . . .	275	WV2084LRC . . . . .	280	WV2430-72W . . . . .	390	WV2448LSHR . . . . .	269
WV2054RSHR . . . . .	269	WV2084MCT. . . . .	283	WV2430-72WL . . . . .	392	WV2448MBULT . . . . .	286
WV2060DSC . . . . .	278	WV2084MLC . . . . .	281	WV2430-72WR . . . . .	392	WV2448MCT. . . . .	283
WV2060ELCR . . . . .	272	WV2084MRC. . . . .	281	WV2430-84BBFT. . . . .	396	WV2448MLCR . . . . .	274
WV2060ELCY . . . . .	273	WV2084RC . . . . .	280	WV2430-84FFT . . . . .	393	WV2448MLL . . . . .	268
WV2060ELR . . . . .	266	WV2090MCT. . . . .	283	WV2430-84MFL . . . . .	397	WV2448MLR. . . . .	268
WV2060ELY . . . . .	267	WV2096MCT. . . . .	283	WV2430-84MFR . . . . .	397	WV2448MRCR . . . . .	274
WV2060ERCR . . . . .	272	WV20EP . . . . .	289	WV2430-84W . . . . .	390	WV2448RSHCR . . . . .	275
WV2060ERCY . . . . .	273	WV23EP . . . . .	289	WV2430-84WL . . . . .	392	WV2448RSHR . . . . .	269
WV2060ERR . . . . .	266	WV24102MCT . . . . .	283	WV2430-84WR . . . . .	392	WV2454ELCR . . . . .	272
WV2060ERY . . . . .	267	WV24108MCT . . . . .	283	WV2430MCT. . . . .	283	WV2454ELCY . . . . .	273
WV2060KC . . . . .	279	WV2418-57BBFO . . . . .	400	WV2430OSC . . . . .	278	WV2454ELR . . . . .	266
WV2060LC. . . . .	280	WV2418-57BBFSSTL. . . . .	402	WV2436-30LF . . . . .	388	WV2454ELY . . . . .	267
WV2060LFC . . . . .	278	WV2418-57BBFSSTR. . . . .	402	WV2436-42LF . . . . .	388	WV2454ERCR . . . . .	272
WV2060LLCR . . . . .	274	WV2418-57BBFTL . . . . .	395	WV2436-57BBFT. . . . .	396	WV2454ERCY . . . . .	273
WV2060LLR . . . . .	268	WV2418-57BBFTR . . . . .	395	WV2436-57FFT . . . . .	393	WV2454ERR . . . . .	266
WV2060LRCR . . . . .	274	WV2418-57FFO . . . . .	399	WV2436-57LF . . . . .	388	WV2454ERY . . . . .	267
WV2060LRR . . . . .	268	WV2418-57FFSSTL. . . . .	401	WV2436-72BBFT. . . . .	396	WV2454LCSHR. . . . .	270
WV2060LSHCR. . . . .	275	WV2418-57FFSSTR . . . . .	401	WV2436-72FFT . . . . .	393	WV2454LLCR . . . . .	274
WV2060LSHR . . . . .	269	WV2418-57FFTL . . . . .	394	WV2436-72W . . . . .	390	WV2454LLR . . . . .	268
WV2060MCT. . . . .	283	WV2418-57FFTR . . . . .	394	WV2436-84BBFT. . . . .	396	WV2454LRCR . . . . .	274
WV2060MLCR . . . . .	274	WV2418-57HL . . . . .	398	WV2436-84FFT . . . . .	393	WV2454LRR . . . . .	268

# Index

VW2454LSHCR. . . . .	275	VW2472LC. . . . .	280	VW2853MA . . . . .	291	VW3078B . . . . .	263
VW2454LSHR . . . . .	269	VW2472LFC . . . . .	278	VW2854MA . . . . .	291	VW3078FINL. . . . .	264
VW2454MCT . . . . .	283	VW2472LLC . . . . .	280	VW2855MA . . . . .	290	VW3078FINR. . . . .	264
VW2454MLCR . . . . .	274	VW2472LRC . . . . .	280	VW2859MA . . . . .	291	VW3078RCT . . . . .	264
VW2454MLL . . . . .	268	VW2472LSHCR. . . . .	275	VW2860MA . . . . .	291	VW3084B . . . . .	263
VW2454MLR . . . . .	268	VW2472LSHR . . . . .	269	VW29EP . . . . .	289	VW3084BC . . . . .	386
VW2454MRCR . . . . .	274	VW2472MCT . . . . .	283	VW3020MLF . . . . .	288	VW3084BCD. . . . .	387
VW2454RCSHR . . . . .	270	VW2472MLC . . . . .	281	VW3020MLM . . . . .	288	VW3084FINL. . . . .	264
VW2454RSHCR . . . . .	275	VW2472MRC. . . . .	281	VW3020MRM . . . . .	288	VW3084FINR. . . . .	264
VW2454RSHR . . . . .	269	VW2472RC . . . . .	280	VW3020MSC. . . . .	287	VW3084MBMTL . . . . .	286
VW2460AHTD-CR . . . . .	256	VW2472RSHCR . . . . .	275	VW3024MLF . . . . .	288	VW3084MBMTR . . . . .	286
VW2460AHTD-EL. . . . .	256	VW2472RSHR . . . . .	269	VW3024MLM . . . . .	288	VW3084RCT . . . . .	264
VW2460AHTD-PN . . . . .	256	VW2472SC . . . . .	278	VW3024MRM . . . . .	288	VW30EP . . . . .	289
VW2460BRET . . . . .	270	VW2472SHD. . . . .	376	VW3024MSC. . . . .	287	VW35EP . . . . .	289
VW2460DSC . . . . .	278	VW2472SHD . . . . .	281	VW3030BC . . . . .	386	VW3620MBSC . . . . .	288
VW2460ELCR . . . . .	272	VW2478KC . . . . .	279	VW3042BC . . . . .	386	VW3620MCT . . . . .	284
VW2460ELCY . . . . .	273	VW2478LC. . . . .	280	VW3042MCT. . . . .	282	VW3620MLF . . . . .	288
VW2460ELR . . . . .	266	VW2478LLC . . . . .	280	VW3048BRET . . . . .	270	VW3620MSC. . . . .	287
VW2460ELY . . . . .	267	VW2478LRC . . . . .	280	VW3048MCT . . . . .	282	VW3624MBSC . . . . .	288
VW2460ERCRCR . . . . .	272	VW2478MCT. . . . .	283	VW3054BC . . . . .	386	VW3624MCT . . . . .	284
VW2460ERCY . . . . .	273	VW2478MLC. . . . .	281	VW3054MCT. . . . .	282	VW3624MLF . . . . .	288
VW2460ERR . . . . .	266	VW2478MRC. . . . .	281	VW3060AHTD-CR . . . . .	256	VW3624MSC. . . . .	287
VW2460ERY . . . . .	267	VW2478RC . . . . .	280	VW3060AHTD-EL. . . . .	256	VW3630BC . . . . .	386
VW2460KC . . . . .	279	VW2484KC . . . . .	279	VW3060AHTD-PN . . . . .	256	VW3636-20ECU . . . . .	271
VW2460LC . . . . .	280	VW2484LC. . . . .	280	VW3060BRET . . . . .	270	VW3636-24ECU . . . . .	271
VW2460LCSHR. . . . .	270	VW2484LLC . . . . .	280	VW3060DD . . . . .	253	VW3642BC . . . . .	386
VW2460LFC . . . . .	278	VW2484LRC . . . . .	280	VW3060DDF . . . . .	254	VW3654BC . . . . .	386
VW2460LLCR . . . . .	274	VW2484MBMTL . . . . .	286	VW3060MCT . . . . .	282	VW3654MCCT24L . . . . .	284
VW2460LLR . . . . .	268	VW2484MBMTR . . . . .	286	VW3060SHD. . . . .	262	VW3654MCCT24R . . . . .	284
VW2460LRCR . . . . .	274	VW2484MCT. . . . .	283	VW3060SHDF . . . . .	262	VW3660MCCT24L . . . . .	284
VW2460LRR . . . . .	268	VW2484MLC. . . . .	281	VW3066AHTD-CR . . . . .	256	VW3660MCCT24R . . . . .	284
VW2460LSHCR. . . . .	275	VW2484MRC. . . . .	281	VW3066AHTD-EL. . . . .	256	VW3666MCCT24L . . . . .	284
VW2460LSHR . . . . .	269	VW2484RC . . . . .	280	VW3066AHTD-PN . . . . .	256	VW3666MCCT24R . . . . .	284
VW2460MBULT . . . . .	286	VW2490MCT. . . . .	283	VW3066B . . . . .	263	VW3666MCT . . . . .	282
VW2460MCT . . . . .	283	VW2496MCT. . . . .	283	VW3066DD . . . . .	253	VW3672AHTD-CR . . . . .	256
VW2460MLCR . . . . .	274	VW24EP . . . . .	289	VW3066DDF . . . . .	254	VW3672AHTD-EL. . . . .	256
VW2460MLL . . . . .	268	VW2807MA . . . . .	290	VW3066LD. . . . .	260	VW3672AHTD-PN . . . . .	256
VW2460MLR . . . . .	268	VW2812MA . . . . .	290	VW3066LDF . . . . .	261	VW3672B . . . . .	263
VW2460MRCR . . . . .	274	VW2814MA . . . . .	291	VW3066MBULT . . . . .	286	VW3672BC . . . . .	386
VW2460RC . . . . .	280	VW2818MA . . . . .	290	VW3066MCT . . . . .	282	VW3672BCD. . . . .	387
VW2460RCSHR . . . . .	270	VW2820MA . . . . .	291	VW3066RD . . . . .	260	VW3672BD . . . . .	252
VW2460RSHCR . . . . .	275	VW2821MA . . . . .	290	VW3066RDF . . . . .	261	VW3672BDF . . . . .	252
VW2460RSHR . . . . .	269	VW2824MA . . . . .	290	VW3066SHD. . . . .	262	VW3672BMCT . . . . .	282
VW2466AHTD-CR . . . . .	256	VW2826MA . . . . .	291	VW3066SHDF . . . . .	262	VW3672DD . . . . .	253
VW2466AHTD-EL. . . . .	256	VW2827MA . . . . .	290	VW3066TD. . . . .	257	VW3672DDF . . . . .	254
VW2466AHTD-PN . . . . .	256	VW2828MA . . . . .	291	VW3072AHTD-CR . . . . .	256	VW3672FINL. . . . .	264
VW2466KC . . . . .	279	VW2830MA . . . . .	291	VW3072AHTD-EL. . . . .	256	VW3672FINR. . . . .	264
VW2466LC . . . . .	280	VW2831MA . . . . .	290	VW3072AHTD-PN . . . . .	256	VW3672LBD . . . . .	259
VW2466LCSHR. . . . .	270	VW2832MA . . . . .	291	VW3072B . . . . .	263	VW3672LBDF . . . . .	259
VW2466LSHCR. . . . .	275	VW2833MA . . . . .	290	VW3072BC . . . . .	386	VW3672LD. . . . .	260
VW2466LSHR . . . . .	269	VW2834MA . . . . .	291	VW3072BCD. . . . .	387	VW3672LDF . . . . .	261
VW2466MCT . . . . .	283	VW2836MA . . . . .	291	VW3072DD . . . . .	253	VW3672MBULT . . . . .	286
VW2466RC . . . . .	280	VW2837MA . . . . .	290	VW3072DDF . . . . .	254	VW3672MCCT24L . . . . .	284
VW2466RCSHR . . . . .	270	VW2838MA . . . . .	291	VW3072FINL. . . . .	264	VW3672MCCT24R . . . . .	284
VW2466RSHCR . . . . .	275	VW2839MA . . . . .	290	VW3072FINR. . . . .	264	VW3672MCT . . . . .	282
VW2466RSHR . . . . .	269	VW2840MA . . . . .	291	VW3072LD. . . . .	260	VW3672RBD. . . . .	259
VW2466SC . . . . .	278	VW2842MA . . . . .	291	VW3072LDF . . . . .	261	VW3672RBDF . . . . .	259
VW2466SHD. . . . .	281, 376	VW2843MA . . . . .	290	VW3072MBULT . . . . .	286	VW3672RCT . . . . .	264
VW2472AHTD-CR . . . . .	256	VW2844MA . . . . .	291	VW3072MCT . . . . .	282	VW3672RD . . . . .	260
VW2472AHTD-EL. . . . .	256	VW2845MA . . . . .	290	VW3072RCT . . . . .	264	VW3672RDF . . . . .	261
VW2472AHTD-PN . . . . .	256	VW2847MA . . . . .	291	VW3072RD . . . . .	260	VW3672SHD. . . . .	262
VW2472BSC . . . . .	279	VW2848MA . . . . .	291	VW3072RDF . . . . .	261	VW3672SHDF . . . . .	262
VW2472DSC . . . . .	278	VW2849MA . . . . .	290	VW3072SHD. . . . .	262	VW3672TD. . . . .	257
VW2472KC . . . . .	279	VW2850MA . . . . .	291	VW3072SHDF . . . . .	262	VW3678B . . . . .	263

# Index

WV3678DD . . . . .	253	VV4820MCT . . . . .	284	WVB1866MT . . . . .	382	WVB2484MT . . . . .	382
WV3678DDF . . . . .	254	VV4824MCT . . . . .	284	WVB1872MT . . . . .	382	WVB2490MT . . . . .	382
WV3678FINL . . . . .	264	VV4852ELCU . . . . .	271	WVB1878MT . . . . .	382	WVB2496MT . . . . .	382
WV3678FINR . . . . .	264	VV4852ERCU . . . . .	271	WVB1884MT . . . . .	382	WVB3072B . . . . .	369
WV3678MBULT . . . . .	286	VV4866MCDT24L . . . . .	285	WVB1890MT . . . . .	382	WVB3072FINL . . . . .	369
WV3678RCT . . . . .	264	VV4866MCDT24R . . . . .	285	WVB1896MT . . . . .	382	WVB3072FINR . . . . .	369
WV3684B . . . . .	263	VV4872CBDL . . . . .	258	WVB1896MT . . . . .	382	WVB3072RCT . . . . .	370
WV3684BC . . . . .	386	VV4872CBDLF . . . . .	258	WVB-18HL18BF360S . . . . .	374	WVB3078B . . . . .	369
WV3684BCD . . . . .	387	VV4872CBDR . . . . .	258	WVB-18OS18BF36BF . . . . .	374	WVB3078FINL . . . . .	369
WV3684BD . . . . .	252	VV4872CBDRF . . . . .	258	WVB-18OS18OF36BF . . . . .	374	WVB3078FINR . . . . .	369
WV3684BDF . . . . .	252	VV4872CBL . . . . .	263	WVB24102MT . . . . .	382	WVB3078RCT . . . . .	370
WV3684DD . . . . .	253	VV4872CBR . . . . .	263	WVB24108MT . . . . .	382	WVB3084B . . . . .	369
WV3684DDF . . . . .	254	VV4872MCBT24L . . . . .	285	WVB2418BF . . . . .	377	WVB3084FINL . . . . .	369
WV3684DF . . . . .	264	VV4872MCBT24R . . . . .	285	WVB2418HL . . . . .	379	WVB3084FINR . . . . .	369
WV3684FINL . . . . .	264	VV4872MCDT24L . . . . .	285	WVB2418HR . . . . .	379	WVB3084RCT . . . . .	370
WV3684FINR . . . . .	264	VV4872MCDT24R . . . . .	285	WVB2418MBF . . . . .	380	WVB-30BF30BF . . . . .	372
WV3684LBD . . . . .	259	VV4872MCDT24R . . . . .	285	WVB2418MHL . . . . .	381	WVB-30BF30HD300S . . . . .	375
WV3684LBDF . . . . .	259	VV48EP . . . . .	289	WVB2418MHR . . . . .	381	WVB-30BF300S . . . . .	372
WV3684LD . . . . .	260	VV5420MCT . . . . .	284	WVB2418MOS . . . . .	381	WVB-30BF300S30BF . . . . .	375
WV3684LDF . . . . .	261	VV5424MCT . . . . .	284	WVB2418MT . . . . .	382	WVB-30BF300S30BF . . . . .	375
WV3684MBULT . . . . .	286	VV6020MCT . . . . .	284	WVB2418MT . . . . .	382	WVB-30BF30SD300S . . . . .	375
WV3684MCCT24L . . . . .	284	VV6024MCT . . . . .	284	WVB2418OF . . . . .	378	WVB-30HD300S . . . . .	372
WV3684MCCT24R . . . . .	284	WVB1024TSP . . . . .	286	WVB2418OS . . . . .	378	WVB-300F300F . . . . .	372
WV3684RBD . . . . .	259	WVB1030TSP . . . . .	286	WVB2430BF . . . . .	377	WVB-300F300F300F . . . . .	375
WV3684RBDF . . . . .	259	WVB1036TSP . . . . .	286	WVB2430HD . . . . .	379	WVB-300F300S300F . . . . .	375
WV3684RCT . . . . .	264	WVB1042TSP . . . . .	286	WVB2430MBF . . . . .	380	WVB-300S30BF . . . . .	372
WV3684RD . . . . .	260	WVB1048TSP . . . . .	286	WVB2430MHD . . . . .	381	WVB-300S30HD . . . . .	372
WV3684RDF . . . . .	261	WVB18102MT . . . . .	382	WVB2430MOS . . . . .	380	WVB-300S30HD30BF . . . . .	375
WV3690MCCT24L . . . . .	284	WVB18108MT . . . . .	382	WVB2430MOS . . . . .	380	WVB-300S300S . . . . .	372
WV3690MCCT24R . . . . .	284	WVB1818BF . . . . .	377	WVB2430MSD . . . . .	381	WVB-300S300S300S . . . . .	375
WV3696MCCT24L . . . . .	284	WVB1818HL . . . . .	379	WVB2430MT . . . . .	382	WVB-300S30SD . . . . .	373
WV3696MCCT24R . . . . .	284	WVB1818HR . . . . .	379	WVB2430OF . . . . .	378	WVB-300S30SD30BF . . . . .	375
WV36EP . . . . .	289	WVB1818MBF . . . . .	380	WVB2430OS . . . . .	378	WVB-30SD300S . . . . .	373
WV41EP . . . . .	289	WVB1818MHL . . . . .	381	WVB2430SD . . . . .	378	WVB-30SD30SD . . . . .	373
WV4220MCT . . . . .	284	WVB1818MHR . . . . .	381	WVB2436BF . . . . .	377	WVB3672B . . . . .	369
WV4224MCT . . . . .	284	WVB1818MOS . . . . .	381	WVB2436HD . . . . .	379	WVB3672FINL . . . . .	369
WV4242-20ECU . . . . .	271	WVB1818MOS . . . . .	380	WVB2436MBF . . . . .	380	WVB3672FINR . . . . .	369
WV4242-24ECU . . . . .	271	WVB1818MT . . . . .	382	WVB2436MHD . . . . .	381	WVB3672RCT . . . . .	370
WV4266MCBT24L . . . . .	285	WVB1818OF . . . . .	378	WVB2436MOS . . . . .	380	WVB3678B . . . . .	369
WV4266MCBT24R . . . . .	285	WVB1818OS . . . . .	378	WVB2436MOS . . . . .	380	WVB3678FINL . . . . .	369
WV4266MCDT24L . . . . .	285	WVB1830BF . . . . .	377	WVB2436MSD . . . . .	381	WVB3678FINR . . . . .	369
WV4266MCDT24R . . . . .	285	WVB1830HD . . . . .	379	WVB2436MT . . . . .	382	WVB3678RCT . . . . .	370
WV4272BD . . . . .	252	WVB1830MBF . . . . .	380	WVB2436OF . . . . .	378	WVB3684B . . . . .	369
WV4272BDF . . . . .	252	WVB1830MHD . . . . .	381	WVB2436OS . . . . .	378	WVB3684FINL . . . . .	369
WV4272BMCT . . . . .	282	WVB1830MOS . . . . .	380	WVB2436SD . . . . .	378	WVB3684FINR . . . . .	369
WV4272CLD . . . . .	260	WVB1830MOS . . . . .	380	WVB2448MT . . . . .	382	WVB3684RCT . . . . .	370
WV4272CLDF . . . . .	260	WVB1830MSD . . . . .	381	WVB2454LCSHR . . . . .	376	WVB-36BF18BF18OS . . . . .	374
WV4272CRD . . . . .	260	WVB1830MT . . . . .	382	WVB2454MT . . . . .	382	WVB-36BF18OF18OS . . . . .	374
WV4272CRDF . . . . .	260	WVB1830OF . . . . .	378	WVB2454RCSHR . . . . .	376	WVB-36BF36BF . . . . .	372
WV4272LBD . . . . .	259	WVB1830OS . . . . .	378	WVB2460LCSHR . . . . .	376	WVB-36BF360S . . . . .	372
WV4272LBDF . . . . .	259	WVB1830SD . . . . .	378	WVB2460MT . . . . .	382	WVB-36HD360S . . . . .	372
WV4272LP . . . . .	264	WVB1836BF . . . . .	377	WVB2460RCSHR . . . . .	376	WVB-36OF36OF . . . . .	372
WV4272MCBT24L . . . . .	285	WVB1836HD . . . . .	379	WVB2466LCSHR . . . . .	376	WVB-36OS18BF18HR . . . . .	374
WV4272MCBT24R . . . . .	285	WVB1836MBF . . . . .	380	WVB2466LSHR . . . . .	376	WVB-36OS36BF . . . . .	372
WV4272MCDT24L . . . . .	285	WVB1836MHD . . . . .	381	WVB2466MT . . . . .	382	WVB-36OS36HD . . . . .	372
WV4272MCDT24R . . . . .	285	WVB1836MOS . . . . .	380	WVB2466RCSHR . . . . .	376	WVB-36OS36OS . . . . .	372
WV4272RBD . . . . .	259	WVB1836MOS . . . . .	380	WVB2466RSHR . . . . .	376	WVB-36OS36SD . . . . .	373
WV4272RBDF . . . . .	259	WVB1836MSD . . . . .	381	WVB2466SHBL . . . . .	376	WVB-36SD360S . . . . .	373
WV4272RP . . . . .	264	WVB1836MT . . . . .	382	WVB2466SHBR . . . . .	376	WVB-36SD36SD . . . . .	373
WV4278LP . . . . .	264	WVB1836OF . . . . .	378	WVB2472LSHR . . . . .	376	WVB4272LP . . . . .	370
WV4278RP . . . . .	264	WVB1836OS . . . . .	378	WVB2472MT . . . . .	382	WVB4272RP . . . . .	370
WV4284LP . . . . .	264	WVB1836SD . . . . .	378	WVB2472RSHR . . . . .	376	WVB4278LP . . . . .	370
WV4284RP . . . . .	264	WVB1848MT . . . . .	382	WVB2472SHBL . . . . .	376	WVB4278RP . . . . .	370
WV42EP . . . . .	289	WVB1854MT . . . . .	382	WVB2472SHBR . . . . .	376	WVB4284LP . . . . .	370
WV47EP . . . . .	289	WVB1860MT . . . . .	382	WVB2478MT . . . . .	382	WVB4284RP . . . . .	370



Notes





Notes