

2015 PRICE LIST **SEATING**

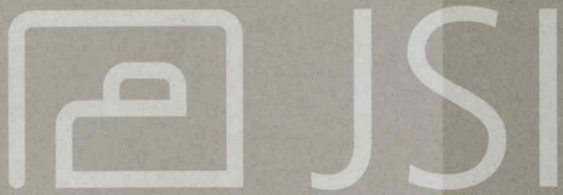

EFFECTIVE 15 OCTOBER 2015

Effective November 1, 2016

5.0%

Price Increase on JSI 2015 Price Lists:
Casegood (V1, V2, V3), Conference, and Seating

List Prices reflect price increase

Table of Contents

Environmental Mission	2	Lounge	
Terms and Conditions	3-5	BeSpace	134-176
Textiles	6-11	Collective Lounge	177-12
Fabric Grading	12-20	Collective Motion	182-12
Specification Tools	21	Connect	200-12
GSA Terms and Conditions	22-24	Corbin	276-12
		Encore	20-297
Swivel		Finn	298-303
Swivel Seating Specifications	20-12	Finn Nu	304-308
Anthem	28-30	Focus	309-311
Avia	12-36	Harbor	312-313
Cabaret	20-38	Hedron	314-325
Harbor	39-40	Hudson	326-328
Madison	41-44	Luci	329-331
Newton	45-47	Moto	332-374
Portrait	48-50	Olympian	376-389
Protocol	51-57	Portrait	390-392
Proxy	58-60	Solara	393-396
Tara	61-67	Ziva	397-420
Tyler	68-70		
Waltham	71-73		
		Occasional Tables	
Guest		Axis	422-12
Guest Seating Specifications	76-12	Bentley	20-429
Accent	78-79	BeSpace	430-431
Cabaret	12-81	Broadway	432-437
Collective	20-83	Brogan	438-439
Gallery	84-85	Collective Lounge	440-441
Gatsby	86-95	Collective Motion	442-443
Harbor	96-97	Connect	444-445
Kendall	98-100	Encore	446-447
Laurel	101-106	Finale	448-452
Madison	107-112	Finn	453-455
Portrait	113-114	Finn Nu	456-458
Profile	115-116	Focus	459-460
Ria	117-118	Hedron	461-462
Solara	119-120	Laurel	463-464
Sosa	121-122	Luci	465-466
Sultan	123-124	Olympian	467-468
Tara	125-126	Shuffle	469-470
Totem	127-128	Solara	471-472
Waltham	129-130	Traditional	473-474
		Ziva	475-476

Environmental Mission

Our vision and goal is a sustaining supplier, manufacturer and customer for the long term protection and preservation of our environment for future generations.

MISSION

To achieve this vision, we are dedicated to ensuring the health and wellbeing of all of our partners, reducing negative impact on the environment, and maintaining price structure by increasing efficiencies and reducing consumption.

The Jasper Group family of brands, including JSI, is an international manufacturer that has been an environmentally conscious organization for more than 80 years.

We are proud to use wood as our primary sustainable material resource and all corporate policies and procedures support the efforts to “recover, recycle, reuse, repurpose, reduce, refuse, and re-engineer”. In doing this, we are committed to the conservation of the environment and its natural resources as well as encouraging our suppliers and customers to do the same. A goal of a “Sustainable Partnership”, supplier, manufacturer and customer, is essential for the long term protection preservation and sustainability of our environment for future generations.

LOCATION

Our manufacturing facilities are located in Southern Indiana. With our diverse product offering and manufacturing capabilities, we provide a single source for all of your project needs allowing you to conserve our fossil fuels and reduce greenhouse gases.

PACKAGING

We place emphasis on the minimal use of disposable packaging while still providing adequate protection to the finished product. Our corrugated packaging is recyclable, reusable, and up to 100% recycled content. We reuse or recycle more than 125 tons of corrugated material annually.

REGULATORY

All of our manufacturing facilities are in compliance with applicable OSHA regulations and meet or exceed all applicable DEM and EPA regulations for air emissions, storm water, and hazardous waste disposal.

MANUFACTURING FACILITIES

Our manufacturing facilities are geared toward eco-efficiency and are encouraged to continually improve and conserve. Solid wood not used in the direct manufacturing process is recovered for the operation of our dry kilns, thus reducing greenhouse gases, the use of fossil fuels, and the burden of waste placed on landfills. Composite panels not used in the direct manufacturing process are ground and sold for use as animal bedding. In addition to other energy savings techniques, our manufacturing facilities use high efficient lighting, make use of power factor capacitors, and encourage all to conserve and reduce energy consumption and water usage. Condensation pumps are used to aid in water conservation as well as extending boiler life.

MANUFACTURING PROCESSES

Our finish processes utilize efficient spray guns and proper spray techniques to reduce wasted material. Excess finish material, solvents, and waste are recycled. Many of the assembly processes use water based glues that contain no hazardous ingredients.

TEXTILES

Many of our fabric options utilize up to 100% recycled content. Our leather alternative program includes selections that contain no toxic materials, plasticizers, heavy metals, or formaldehyde and have a 100% biodegradable back cloth. Some of the available panel fabric used, if discarded is a biological nutrient for the soil. Most of the components (foam, batting, and polycord) used in upholstered products are recyclable and contain various percentages of recycled content. Excess fabrics and leathers not utilized in the upholstery process go to recyclers and local charities for additional use.

WOOD

Wood is the most diverse, most process friendly, and most widely utilized natural resource in mankind’s history. No other natural resource can match the environmental advantages of wood, including being renewable, recyclable, natural, carbon negative, and biodegradable. Utilizing the sun’s energy, trees grow and remove carbon dioxide from the air while giving off oxygen to benefit the entire planet. Approximately 49% of wood’s dry weight is carbon and harvesting mature trees in a sustainable forest, which has slowed in the absorption of carbon dioxide, allows the photosynthetic cycle to continue at full optimization and allow for the carbon to remain sequestered. We are proud to use wood as our primary “sustainable” renewable resource.

WOOD OPTIONS

Many environmentally friendly solid wood and engineered wood options are available for quote, including: Lyptus®, Plyboo®, reclaimed woods, agricultural and post-consumer waste fiber products, soy-based resin bio-composites, etc.

INDOOR AIR QUALITY

Our goal is to reduce the impact our products will have on the indoor air quality. We practice the latest technologies and utilize a third party to assure we meet this goal. GreenGuard, one of the leaders in IAQ certification, continues to certify our product offering, awarding us the UL2818 - GreenGuard Indoor Air Quality standard.

PARTNERSHIPS

BIFMA
Business and Institutional Furniture Manufacturer Association
 USGBC
United States Green Building Council
 IIDA
International Interior Design Association
 FSC
Forest Stewardship Council
 GreenGuard

Warranty (Seating)

JSI warrants, to the original purchaser that each piece of furniture will be free from defects in workmanship, given normal use for a period of fifteen (15) years of single shift service. Pneumatic lifts and casters are warranted to be free from defects in material and workmanship for a period of five (5) years. Fabric manufacturer's warranty will apply. Electrical items not manufactured by JSI are covered for a period of one (1) year. JSI will, at its option, repair or replace any defective merchandise with the terms of this warranty.

JSI makes no expressed or implied warranties to any product and, in particular, makes no warranty of merchantability of fitness for any particular purpose.

This warranty does not cover:

- + Natural variations in color, texture of wood, and covering materials over which JSI has no control.
- + Normal wear, color fastness, shrinkage, wrinkling, stretching of leather, and textiles.
- + Damage caused by transportation or installation companies.
- + Damage created by any accident, user modification, misuse of product, or neglect of product care.
- + Damage resulting from extreme climate conditions.

Unique Characteristic of Natural Woods and Veneers

JSI uses high quality wood and veneer harvested from sustainably managed forests. Every tree has unique and defining characteristics, like fingerprints. These characteristics can be defined by differences in color, grain configurations, and texture. These characteristics will be more noticeable if the product has a clear or lighter finish.

Maple and Cherry species have a higher degree of uneven distribution of grain, small color streaks, and pin knots.

At JSI, we take care of selecting woods and veneers that are used in our products. With this in mind, we hope you appreciate the beauty of each tree's fingerprints. Products will not be replaced due to these natural characteristics.

Veneers can be sliced in a variety of ways to create unique patterns. JSI uses several different patterns, as shown below.



flat cut



quarter cut



rift cut

JSI uses select beech, cherry, maple, oak and walnut cut wood products to produce the desired look of our furniture products.

Please reference the featured highlights of each product line to identify the species and grain patterns available for that product.

Finish - Top Coat

To reduce hazardous formaldehyde emissions, we use our proprietary specially designed top coat, DuraTex™. Our finish significantly reduces hazardous formaldehyde emissions and helps improve indoor air quality.

Finish - Color/Stains

A wide range of stains are available to bring out the beautiful characteristics of each wood species. We coordinate finish color between our veneer stains and solid lumber stains; however, not all may be a perfect match. The stains are continually reviewed for accuracy of color, as well as a constant monitoring of the latest color trends in the furniture market.

Finish - Matching

Due to the natural characteristics of wood, environmental effects, and material upgrades, JSI cannot guarantee exact finish matches on existing furniture previously ordered.

If an exact match is required to accompany existing furniture, it must be specified at the time of order placement, so specific internal procedures can be followed to ensure a proper and acceptable finish match. We reserve the right to change our finish formula at any time to improve safety, quality, and appearance. Unless a finish match for existing furniture is requested at the time of ordering, we accept no liability for finish that may not match the existing furniture from prior orders.

Solid lumber may inherently have mineral streaks, pits, and various other natural occurrences. Care is taken in selecting the solid lumber parts to coordinate with the requested finish. This internal selection process is subject to availability of solid lumber parts.

Custom/Special Finishes

JSI, upon request, will accommodate special finishes. A written request is required to proceed with custom finish orders. A sample reference is required for first time matches and must be included with the written request.

There is a one time charge of **\$289 list per order** for any non-standard wood finish.

Orders will be entered noting the special finish. A sample match will be provided to the customer. Written approval is needed before the finish process can be started. Delays in approval may have an impact on lead times.

Every effort will be made to create the requested match; however, an acceptable match may not be possible because of natural variations of wood. These natural variations can also cause minor differences in the final finish product.

Samples

Samples of standard wood finishes, paint colors, metal colors, and standard laminate are available upon request. The fastest way for requests to be filled is by using our website. See below for options to request samples.

Website – jsifurniture.com (click the resource tab)

JSI Sales representatives

Phone – 800.457.4511 – Customer Service

Fax – 812.771.4652

Pricing

Prices found in this document or on our website are list prices in U.S. dollars for standard product delivery to one destination. Prices do not include storage, installation, or taxes. Possession of this price list does not constitute an offer to sell. Orders can only be received from approved authorized JSI dealers.

Prices and product information in this document, as well as our website, are subject to change without notice. Reference website for most up to date product offering and pricing.

Orders

Detailed specification pages are available in the price list at the beginning of each series.

To assist in submitting a complete order, an order check list can be referenced for each series.

Additional information may be obtained by consulting the Customer Service Department or our website.

Indicate shipping address if different from billing address.

Send Orders To:

US Mail – JSI
 225 Clay Street
 Jasper, IN 47546
 Fax – 812-482-1548
 Email – orders@jaspergroup.us.com

JSI reserves the right to make changes in dimensions, styles, or specifications if we believe these changes will improve the safety, quality, or appearance of the product.

Acceptance of orders will be subject to credit approval, barring any acts of governments, or any other causes beyond our control (e.g. strikes, fire, embargo of materials, etc).

Product Modifications

While we offer a wide range of products to accommodate many possible solutions, we also recognize the needs for our products to be modified from our standard offering.

In the series introduction section of each product, we address modification options for that series.

To see if the desired modification is possible, please contact our Customer Service Department for a quote. Note that order quantities and material availability can affect the quote. Additional information may be requested to fully quote modifications.

Order Acknowledgments

All orders will be acknowledged promptly, showing how the order was entered, shipping time, and other information pertinent to the order. It is the purchaser's responsibility to verify all the information on the acknowledgment carefully and notify us immediately, in writing, of any discrepancies.

Published ship dates are contingent upon adverse conditions; however, every effort is made to ship as acknowledged.

Order Cancellations

All cancellations must be made in writing. Administration and/or labor charges may be incurred by the purchaser depending upon the stage of the order. Orders cannot be canceled after the finish process has begun without incurring substantial re-stocking charges.

Once production has begun on product modifications or special finishes the orders cannot be canceled. Items purchased specifically from our vendors for the order, such as textiles or laminates, are subject to our vendor's cancellation terms and re-stocking fees.

Order Changes

All changes to an order must be in writing and dated. Order changes are subject to our ability to conform. Administration and/or labor charges may be incurred by dealer depending upon the stage of the order. No change can occur once production is started.

Quickship

Items indicated with a Quickship symbol  ship within 10 business days of receipt of a clean, credit approved purchase order. You may select up to 20 seats from the following series: Cabaret swivel or guest, Connect lounge, Corbin lounge, Encore lounge, Gatsby guest, Hedron lounge, Kendall guest, Laurel guest, Madison swivel and guest, Newton swivel, Olympian lounge, Profile guest, Protocol swivel and Tyler swivel. See individual product pages for those models available. Quickship fabrics are listed on pages 8 to 11. Available capacity is filled by orders as they are received. If normal 10 day Quickship is not available because capacity has been filled, you will be immediately notified. Changes and cancellations to Quickship orders are not allowed under any circumstances.

Delivery

Our freight policy consists of prepaid freight to the 48 contiguous states; all other shipments prepaid to port of exit ONLY. JSI reserves the right to select the appropriate carrier and shipment routes. Standard deliveries require docks that can accommodate 75 foot trucks. Pricing in this book is for standard delivery. Standard delivery does not include non-dock delivery, inside delivery, residential delivery, or installation of product. Special requests for delivery should be done at the time of ordering. See below for charges for special delivery.

Orders of less than \$1000 net will be assessed a handling charge of \$75 net per order.

Any charges arising from failure to meet shipment, re-routing while in transit, or carrier storage charges are the responsibility of the customer.

Contact Customer Service to inquire about skidding of products, special crating of products, blanket wrap services, and product installation. These requests must be made at the time of order.

Freight Damage

JSI products are packed in cartons and meet or exceed existing codes for furniture and seating products. All shipments are delivered to the carrier in good condition and our liability ceases thereafter. If delivery arrives short or damaged, contact the carrier immediately to file a claim. In the event of concealed damage, notify the carrier and request immediate inspection. Failure to file a claim within 15 days after receipt of merchandise constitutes acceptance and a waiver of any such claims. Please inspect merchandise immediately upon receipt, otherwise there is no recourse. Keep all cartons and packing material, discarding these materials may negate your claim. Storage of product in areas of uncontrolled humidity and temperature may cause damage to the product and void the JSI warranty.

Repairs

JSI will not issue credit allowance for any type of repairs without prior written consent.

Sales order, product model numbers, and reason for repair will be expected in order to process the repair request. A digital photo will help to expedite the request. JSI reserves the right to recommend solutions for repair.

Returns ▲

No merchandise may be returned to JSI without a signed Return Good Authorization (RGA) form issued by our Customer Service Department. Any authorized return not due to damage or defect will be accessed a 45% restocking fee and all return freight charges must be prepaid. Additional restocking fees may apply for any modification, special or custom built product.

Liability for defective merchandise shall be limited to replacement or repair.

Under no circumstance can we accept COD (Cash On Delivery) returns. Any such shipment will be refused.

Replacement Parts

Obtain information and pricing on replacement parts by contacting Customer Service. Please have the model number available when requesting replacement parts. Additional information may be required to ensure proper replacement parts.

Care and Maintenance

Care of Upholstery Surfaces

Cleanability will vary based on the fabric type. For best results, a professional service is recommended. Dirt and crumbs may be gently brushed or vacuumed off. Spills should be wiped up immediately with a cloth. Vinyl textiles can be cleaned with warm soapy water and then wiped down with a warm damp cloth. For more details on any JSI carded fabric and vinyl, please visit our website at jsifurniture.com or consult the back of the appropriate swatch card for cleaning codes and any specific instructions. For COM materials, consult with the individual textile manufacturer for cleaning codes and any specific instructions pertaining to your particular fabric.

Maintenance of Mechanical Parts

Clean any lint or debris from the moving parts of the base mechanisms. Mechanisms have been designed and tested to not require lubrication under normal conditions; however, lubricant can be used if needed.

Care of Wood Edges and Veneer Surfaces

Clean all surfaces frequently with water dampened soft cloth, moving the cloth with the grain direction. Immediately remove any liquids that come in contact with wood surfaces with a blotting action to absorb liquid. Buff dry. Lift objects to move them, never pull them across the finished surface. For an additional safeguard, use a protective surface pad. This will ensure a lasting finish by protecting your furniture from possible damage caused by pens, cups and sharp objects. Avoid exposure of furniture to extremes of heat and cold, or to wide humidity variances. Avoid exposure of furniture to strong sunlight. Avoid exposure of furniture to harsh solvents such as nail polish remover, acetates, etc., as it will cause finish deterioration. If using a protective glass top, place spacer pads under the glass top to allow the wood to breath.

Care of Metal Finishes

Wipe smooth powder coat finishes and textured metals with a damp cloth. For stubborn stains and grease marks, use soap and water. Lightly brush textiles metals with a soft, dry brush to remove dirt.

Fire Retardancy

At a minimum standard, all JSI upholstered products are manufactured to comply with Bureau of Electronics, Appliance Repair, Home Furnishings and Thermal Insulation-Technical Bulletin 117-2013 issued by State of California Department of Consumer Affairs. With a January 1, 2015 effective date, this standard was passed and requires upholstered furniture to be safer from the hazards associated with smolder ignition in all four (4) categories of materials, as applicable.

Compliance with more stringent codes may require special manufacturing considerations and upcharges.

California Technical Bulletin 133 (CAL 133)

JSI uses a barrier material between the foam cushioning and the upholstery cover in order to comply with CAL 133. The standard upcharge on products specified to comply with CAL 133 is \$58 list per yard of textile.

JSI has performed a series of full scale fire tests on samples - representing a variety of product styles and worst case scenarios of upholstery covers - to comply with the requirements of the state of California Technical Bulletin 133 (CAL 133). Products in compliance will be labeled that they have been manufactured to meet the CAL 133 standard. Only products with internal test data can be labeled.

Some product designs and fabric cannot be combined to comply with CAL 133. Because of this, we reserve the right to reject any request for an upholstery cover, including COM, or product style that we feel may compromise the integrity or safety of a product specified to comply with CAL 133.

Contact Customer Service for a quote if you require laboratory certification that a specific product and upholstery combination WILL PASS CAL 133. The quotation will include testing, video, and transportation charges plus the list cost of the sample.

Our standard lead time will apply to products that do not require certification. Allow an additional six weeks over the standard lead time for products that need actual laboratory certification.

The end user, specifier and/or dealer have the responsibility to make sure all products specified will meet the flammability and safety codes of the jurisdiction where the products will be located and used.

Textile Carded Programs

JSI is proud to partner with Maharam, Momentum, Ultraleather and Wollsdorf Leather. Please refer to the respective pages in this pricer for each of these partners. Scan the QR codes on the back of the swatch card for latest grades and other information.

Textile Grade-In Programs

For the convenience of our specifiers, we have graded in the following suppliers:

Arc Com	Pallas
DesignTex	Stinson
Maharam	Ultrafabrics
Mayer	Wollsdorf Leather
Momentum	

Please contact Customer Service for pricing grades on textiles and leathers not listed.

Indicate on purchase order if JSI is to order the fabric.

For samples, contact Customer Service.

Grades and availability of fabric are subject to change without notice. Changes could include but are not limited to price increase, discontinued patterns, discontinued colors, etc. See jsifurniture.com for up to date information.

Many textiles have repeats and the additional yardage required has been factored in for textiles ordered through the JSI Carded and Grade-In Programs. We reserve the right not to match textiles with a horizontal or vertical repeat greater than 17". Additional charges may apply for textile being applied with special instructions.

COM Policy

Refer to the COM price column for list prices.

All yardage requirements listed in the price list are based upon 54" plain non-directional material. The textile on most products is cut "up the roll"; refer to the check list pages for each individual series for further information.

Additional yardage may be required. Contact Customer Service for any of the following conditions to assure proper yardage:

- + horizontal repeats or vertical repeats greater than 3"
- + textile less than 54" wide off the roll
- + patterned textile to be applied a special way

To assure quick turn around and accurate calculation of yardage, please supply the following information:

- + supplier's name
- + pattern name and color name
- + the JSI model numbers and the order quantity
- + any special direction and/or special instructions

We cannot assume responsibility for defective COM delivery to us or for the tailoring quality issues some textiles may create. Bulky textiles, thin weight textiles or fiber content may not tailor well on some models.

COM Fabric Repeat Guide[▲]

Roll Width	Plain Fabric	1" - 5" Repeat	6" - 10" Repeat	11" - 15" Repeat	16" - 20" Repeat	21" - 30" Repeat	31" - 40" Repeat	41" - 50" Repeat
54"	0%	10%	15%	20%	25%	30%	40%	50%
53" to 51"	15%	20%	25%	30%	35%	40%	50%	60%
50" to 48"	30%	35%	40%	45%	50%	55%	70%	90%
47" to 36"	60%	65%	70%	75%	80%	85%	100%	120%

The percentage represents the additional fabric yardage that needs to be added to the COM yardage. Contact Customer Service for repeats greater than 50".

Example:

Connect Lounge - CTI32125 - COM 9 yds
Momentum Avenue Java with a repeat of 7 ¾" L, 7 ¾" W, (54" wide roll)
9 COM yds + 15% additional = 10 ⅜" total yds

Large Repeats and Striped Fabrics

JSI does not recommend large fabric repeats or striped fabrics on large curved lounge sections. The geometry prevents matching the patterns at the seams.

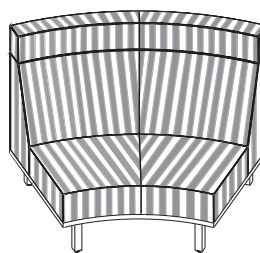

Connect example shown

Contact Customer Service with questions or for suggestions on how to achieve the aesthetics you desire.

*Tips: use contrasting fabric
request fabric pattern not be matched
run fabric railroad*

COL Policy

Refer to the COL price column for list prices.

Customer's own leather requirements are based on an average hide of 50 square feet.

Contact Customer Service for requirements on any other sizes.

All square footage requirements are based upon usable footage. The shape of the hide and the usable footage may make it necessary for us to request additional leather.

Placing Orders with COM or COL

COM & COL orders must include the following:

- + model number where the COM or COL will be applied
- + textile/leather supplier's name
- + sample of the textile/leather attached to order
- + special application instructions

Ship COM/COL prepaid to the following:

JSI

Attn: COM Dept
932 Mill Street
Jasper, IN 47546

Make sure the supplier tags the shipment with the customer purchase order number and sales order numbers if available.

All COM/COL orders will ship at standard lead time from the delivery of the COM/COL, except for orders requiring special custom matched finishes or special application of the COM/COL.

Guide Order Form for COM and COL

1 Order Information:

Acknowledgment #: _____ **Purchase Order #:** _____

JSI Representative: _____

Dealer Name/Project Name: _____

Contact: _____

Address: _____

Phone: _____ **Email:** _____

Model Number(s) Receiving COM / COL: _____

2 Select off the bolt application: *(Check one of the boxes)*

Up the roll (standard on most seating) **Railroaded**

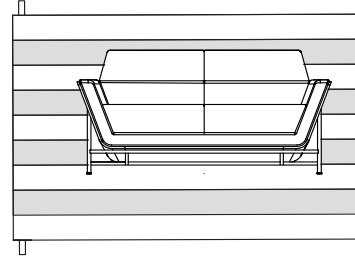
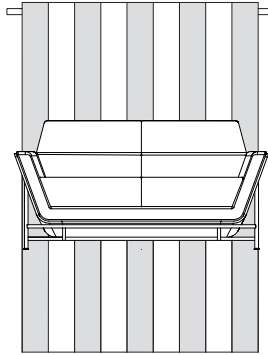

photo copy or scan

3 Additional information:

4

Attach 4" x 4" sample here.

Textile and Leather Swatch Card Program

Maharam - Value Reference 5 Card

Pattern - Bar Grade - C		Pattern - Disc Grade - C		Pattern - Oblique Grade - C		Pattern - Pick Grade - C	
Colorways		Colorways		Colorways		Colorways	
003	005	001	005	001	005	001	006
004	007	002	006	002	006	002	007
		003	007	003	007	003	008
		004		004		004	009
						005	010
Pattern - Coin Grade - C		Pattern - Divide Grade - C				Pattern - Technic Grade - C	
Colorways		Colorways				Colorways	
001	005	005	009			001	004
002	006					002	005
003	007					003	
004							

Need it.

JSI Quickship

patterns and colors listed above are available for quickship

Maharam - Manner / Medium / Messenger / Metric Card

Pattern - Manner (MN) Grade - C		Pattern - Medium (MD) Grade - C		Pattern - Messenger (MG) Grade - C		Pattern - Metric (MT) Grade - C	
Colorways		Colorways		Colorways		Colorways	
013 Ablaze	005 Hush *	003 Alloy *	008 Pecan	077 Ash *	072 Maize *	026 Admiral	002 Fog
022 Aquatic	018 Lioness	006 Bark *	029 Pistachio *	067 Aster *	025 Mao *	020 Alligator *	013 Lava *
026 Basin *	001 Magic *	052 Blackberry	040 Pool *	041 Azure *	048 Neon *	024 Anchor *	007 Mineral
016 Butterscotch	006 Nuance	051 Cascade	016 Port *	001 Balsa *	040 Nile *	009 Arabica	014 Oriole *
019 Caper	020 Parakeet	050 Cosmic	032 Prospect *	008 Bayou *	029 Onyx *	008 Bittersweet	001 Phantom
002 Carob	009 Pathway	036 Delight *	012 Pumpkin *	085 Beyond	079 Oyster	022 Bonsai	018 Pollen *
008 Cocoa *	014 Peel	007 Espresso *	001 Raven *	045 Cactus *	080 Pensive	011 Brick	028 Scuba*
010 Cola	015 Penny *	004 Flax *	045 Sculpture	061 Capri *	060 Peridot*	017 Caramel	027 Seaport*
023 Cottage	003 Porpoise *	047 Hike	002 Smoke *	066 Cassis	024 Poppy *	012 Cardinal *	004 Sourdough
024 Dahlia	027 Schooner *	014 Laser *	048 Tangle	069 Cherry *	084 Robust	015 Cedar	023 Tar
011 Ember	007 Thicket *	022 Marina *	046 Thatched	083 Chili	071 Satsuma *	010 Cerise	005 Toffee
004 Flint	025 Vivid	053 Nasturtium	044 Washed	031 Cloud *	007 Shadow *	006 Driftwood	019 Tupelo
021 Greenway	012 Wagon	039 Nautical *	054 Wooded	038 Depth *	058 Snow *	021 Envy	025 Twilight
017 Harvest		049 Pacific		088 Electric	063 Squall *	003 Fleece	
				087 Everglade	053 Tangelo *		
				059 Fennel	006 Tobacco *		
				082 Fireside	078 Tusk *		
				076 Fossil *	062 Ultramarine *		
				081 Husk	070 Vibrant *		
				050 Hydrangea *	086 Voyage		
				046 Ice *	010 Zinc *		
				054 Lumine *			

Need it.

JSI Quickship

**colors marked with an asterisk are available for quickship*

Textile and Leather Swatch Card Program

Momentum - Inspired Solutions

Pattern - Camber Grade - G Colorways CAM01 Anatto CAM03 Zinc CAM02 Deep		Pattern - Cover Cloth Grade - C Colorways CVR01 Antique CVR08 Platinum CVR02 Cyan CVR09 Shire CVR03 Delft CVR10 Sorrel CVR04 Graphite CVR11 Taupe CVR05 Heirloom CVR12 Vessel CVR07 Oat CVR13 Zest		Pattern - Drift Grade - G Colorways DRI01 Beacon DRI03 Stellar DRI02 Rime		Pattern - Keynote Grade - D Colorways KYN01 Granite KYN03 Palmetto KYN02 Mesa	
Pattern - Centric Grade - F Colorways CEN01 Anatto CEN02 Sediment		Pattern - Dash Grade - F Colorways DAS01 Batik DAS02 Zinc		Pattern - Jitney Grade - E Colorways JIT01 Bay JIT10 Pool JIT03 Dune JIT11 Reed JIT04 Forest JIT12 Salt JIT06 Lake JIT13 Slate JIT07 Oar JIT14 Teak JIT08 Pear JIT15 Tulip		Pattern - Torque Grade - H Colorways TRQ01 Quarry TRQ02 Tropicalia	
						Pattern - Wander Grade - F Colorways WAN01 Limelight WAN03 Sterling WAN02 Orangerie	

NOW!
Need it.
JSI Quickship
patterns and colors listed above are available for quickship

Momentum - Color Card

Pattern - Infinity Grade - B Colorways INF01 Aluminum INF17 Maize INF02 Aster INF18 Papaya INF03 Atoll INF19 Pewter INF04 Barley INF22 Rinse INF05 Berry INF24 Sable INF07 Capri INF25 Stucco INF08 Dove INF26 Terrain INF10 Graphite INF30 Vine INF11 Gull		Pattern - Marathon Grade - B Colorways MRN01 Alert MRN16 Noir MRN03 Caravel MRN18 Oz MRN06 Clove MRN19 Pinot MRN07 Curry MRN20 Pollen MRN08 Cyan MRN21 Rain MRN09 Deep MRN23 Sprite MRN10 Flax MRN24 Storm MRN12 Foliage MRN27 Toile MRN13 Herb MRN29 Vivacious MRN15 Marigold		Pattern - Odyssey Grade - B Colorways ODY02 Amp ODY17 Linen ODY03 Breeze ODY19 Maritime ODY06 Cedar ODY23 Primary ODY07 Craft ODY24 Roast ODY08 Cruise ODY25 Rue ODY10 Eggplant ODY26 Sangria ODY11 Emerald ODY27 Skim ODY12 Fossil ODY28 Smith ODY13 Ink ODY29 Tinge ODY15 Iris ODY30 Western		Pattern - Tradition Grade - B Colorways TRD01 Ash TRD14 Malbec TRD02 Branch TRD16 Mist TRD03 Class TRD18 Plated TRD04 Distant TRD19 Regal TRD05 Flirt TRD21 Soar TRD06 Frond TRD22 Soy TRD08 Hedge TRD24 Sprout TRD09 Hidden TRD26 Sun TRD12 Kelly TRD27 Tango TRD13 Latte TRD29 Wash	
		Pattern - Millennium Grade - B Colorways MLL02 Amber MLL20 Plateau MLL04 Cascade MLL21 Pool MLL06 Cerise MLL22 Pyrite MLL07 Clean MLL23 Safari MLL08 Coastal MLL24 Sapphire MLL10 Crisp MLL25 Spark MLL11 Electric MLL26 Steel MLL17 Onyx MLL27 Tanzanite MLL18 Orchid MLL28 Thrill MLL19 Peridot MLL30 Zinc					

NOW!
Need it.
JSI Quickship
patterns and colors listed above are available for quickship

Textile and Leather Swatch Card Program

Momentum - Everyday Card

Pattern - Amuse		Pattern - Fuse		Pattern - Knack		Pattern - Syntax	
Grade - D		Grade - A		Grade - C		Grade - C	
Colorways		Colorways		Colorways		Colorways	
AMU01 Admiral	AMU03 Mocha	FUS11 Azurean	FUS06 Morel	KNA05 Brisk	KNA01 Reed	SNY01 Mahogany	SNY05 Turquoise
AMU02 Alloy	AMU04 Quartz	FUS01 Carmine	FUS07 Pepper	KNA06 Carbon	KNA03 Zest	SNY02 Nectar	SNY06 Violet
Pattern - Bangle		FUS02 Cress	FUS08 Pimento	KNA08 Filament	KNA13 Zing	SNY03 Plant	SNY07 Pewter
Grade - A`		FUS03 Ginger	FUS13 Pristine	KNA09 Fresco		SNY04 Shale	
Colorways		FUS12 Iris	FUS09 Saffron	Pattern - Lineup		Pattern - Vox	
BAN01 Baltic	BAN05 Sable	FUS04 Lunar	FUS10 Walnut	Grade - C		Grade - B	
BAN02 Cork	BAN06 Suede	FUS05 Malted		Colorways		Colorways	
BAN03 Granite	BAN07 Teak	Pattern - Habit		LUP01 Baltic	LUP05 Shadow	VOX13 Bark	VOX15 Morel
BAN04 Orchid		Grade - C		LUP02 Fern	LUP06 Spice	VOX01 Black	VOX09 Mystic
Pattern - Decode		Colorways		LUP03 Pewter	LUP07 Tranquil	VOX02 Cocoa	VOX10 Navy
Grade - C		HAB01 Aspen	HAB03 Kindle	LUP04 Sandstone		VOX03 Downpour	VOX16 Oat
Colorways		HAB02 Dune	HAB04 Pier	Pattern - Origin		VOX05 Forthe	VOX17 Snap
DEC01 Alloy	DEC03 Elm	Pattern - Insight		Grade - A		VOX08 Hot	VOX18 Turquoise
DEC02 Blaze	DEC04 Grove	Grade - A		Colorways		VOX14 Limelight	
Pattern - Free		Colorways		ORG01 Amethyst	ORG08 Jet		
Grade - C		INS11 Bark	INS10 Real Red	ORG17 Basalt	ORG23 Malt		
Colorways		INS07 Ebony	INS03 Summit	ORG18 Caraway	ORG24 Manta		
FRE01 Cocoa	FRE06 Pearl	INS08 Fossil	INS12 Wasabi	ORG19 Eureka	ORG25 Mikan		
FRE02 Evening	FRE07 Platinum	INS09 Periwinkle		ORG20 Euro	ORG26 Poppy		
				ORG22 Gaia	ORG10 Sapphire		
				ORG07 Iron			

NOW!

Need it.
JSI Quickship

patterns and colors listed above are available for quickship

Momentum - Composite Solutions Card

Pattern - Beeline		Pattern - Canter		Pattern - Cashmere II		Pattern - Kindred	
Grade - C		Grade - C		Grade - C		Grade - F	
Colorways		Colorways		Colorways		Colorways	
BEL01 Canvas	BEL12 Sisal	CNR01 Alfalfa	CNR24 Pyrite	CA132 Acorn	CA139 Olive	KND01 Chai	KND05 Mist
BEL06 Fossil	BEL13 Sprout	CNR15 Baltic	CNR09 Sable	CA128 Bone	CA136 Seashore	KND02 Flint	KND06 Orangery
BEL07 Geyser	BEL16 Walnut	CNR04 Chestnut	CNR10 Saddle	CA134 Chestnut	CA131 Smoke	KND03 Grain	KND07 Union
BEL11 Portobello		CNR06 Mica	CNR11 Safari	CA127 Ebony	CA130 Taupe	KND04 Macaw	
Pattern - Bravo II		CNR07 Night	CNR12 Sand	CA143 Fennel	CA135 Wine	Pattern - Silica	
Grade - D		CNR23 Nimbus	CNR13 Willow	CA138 Nile	CA120 Yacht	Grade - F	
Colorways		CNR08 Onyx		CA122 Ocean		Colorways	
BRV21 Bark	BRV15 Night	Pattern - EON		Pattern - EON		SIL01 Alloy	SIL20 Haze
BRV19 Black	BRV04 Ranch	Grade - C		Grade - C		SIL02 Appletini	SIL37 Jewel
BRV20 Cinder	BRV07 Saddle	Colorways		Colorways		SIL04 Bistro	SIL23 Manor
BRV23 Clay	BRV16 Sunset	EON01 Freshwater	EON05 Nocturnal	EON01 Freshwater	EON05 Nocturnal	SIL07 Brownstone	SIL24 Marigold
BRV12 Dusk	BRV01 Tumbleweed	EON02 Goldmine	EON06 Omega	EON02 Goldmine	EON06 Omega	SIL08 Burnished	SIL38 Nero
BRV02 Hematite	BRV09 Twilight	EON03 Humid	EON07 Path	EON03 Humid	EON07 Path	SIL11 Coppercrest	SIL39 Petunia
BRV17 Iron		EON04 Mystery		EON04 Mystery		SIL12 Cumulus	SIL40 Quartz
						SIL15 Gallant	SIL41 Sands
						SIL17 Ginger	SIL33 Skyward

composition solutions card patterns continued on the next page

Textile and Leather Swatch Card Program

Momentum - Composite Solutions Card *(Continued)*

Pattern - Silica Leather Grade - F		Pattern - Silica Tech Grade - F		Pattern - Sublime II Grade - C		Pattern - Velocity Grade - D	
Colorways		Colorways		Colorways		Colorways	
SLL01 Almond	SLL09 Hyacinth	SLT01 Calm	SLT15 Tangelo	SUB05 Agate	SUB06 Oxide	VEL01 Aloe	VEL05 Sandstone
SLL02 Aloe	SLL10 Ink	SLT02 Fog	SLT16 Tanzanite	SUB09 Beryl	SUB15 Patina	VEL02 Azure	VEL06 Snow
SLL03 Barley	SLL11 Juniper	SLT05 Macadamia	SLT10 Urbanite	SUB03 Bronze	SUB07 Peridot	VEL03 Charcoal	VEL07 Sycamore
SLL04 Chambray	SLL12 Lichen	SLT06 Mineralize	SLT11 Verdigris	SUB14 Gold		VEL04 Pond	
SLL05 Driftwood	SLL13 Madder	SLT14 Nightfall	SLT12 Vintage				
SLL06 Dune	SLL14 Pewter	SLT07 Paloma	SLT13 Willow				
SLL07 Earthen	SLL15 Raisin	SLT08 Sablewood					
SLL08 Eclipse	SLL16 Saddle	SLT09 Sandstone					

NOW!
Need it.
JSI Quickship

composite solutions patterns and colors listed are available for quickship

Ultrafabrics

Pattern - Brisa Grade - E		Pattern - Pony Grade - E		Pattern - Ultraleather Grade - E		Pattern - Viva Grade - E	
Colorways		Colorways		Colorways		Colorways	
BRI36 Apple Green	BRI12 Night Navy *	PNY01 Bay	PNY05 Galacian	ULL16 Adobe	ULL20 Raven Wing	VIV01 Aluminum	VIV08 Lantern
BRI34 Ash	BRI38 Pomp. Red	PNY02 Black Forest	PNY06 Marengo	ULL10 Arctic	ULL46 Stone *	VIV02 Baha	VIV09 Lava
BRI14 Aztec	BRI19 Salsa	PNY03 Danube	PNY07 Mustang	ULL48 Baltic	ULL49 Toro	VIV03 Balsa	VIV10 Maize
BRI37 Bark	BRI39 Shiitake	PNY04 Dapple	PNY08 Shire	ULL07 Buff	ULL09 Walnut *	VIV04 Cinder	VIV11 Nublan
BRI31 Birch	BRI32 Sterling Blue			ULL47 Charcoal	ULL50 Whiskey	VIV05 Driftwood	VIV12 Poinsettia
BRI21 Black Onyx *	BRI17 Truffle	Pattern - Uccello		ULL42 Fudge	ULL45 White	VIV06 Elm	VIV13 Sugar
BRI20 Cabernet	BRI24 White *	Grade - E		ULL11 Papyrus*		VIV07 Imperial	
BRI10 Desert Clay		Colorways					
		UCC01 Beech	UCC06 Oyster				
		UCC02 Beeswax	UCC07 Possum				
		UCC03 Fox	UCC08 Seal				
		UCC04 Husk	UCC09 Sequoia				
		UCC05 Mink	UCC10 Thicket				
Pattern - Brisa Distressed Grade - E							
Colorways							
BDS05 Bridle	BDS09 Saddle						
BDS03 Buckskin	BDS07 Steerhide						
BDS08 Iron	BDS04 Waylan						
BDS06 Lasso							

NOW!
Need it.
JSI Quickship

**colors marked with an asterisk are available for quickship*

Wollsdorf Leather Card

Pattern - FOC Earth Grade - L2				Pattern - Euroglazed Grade - L2	
Colorways				Colorways	
FOC105 Antra	FOC032 Chocolate	FOC046 Lagoon	FOC049 Spirit	EUR003 Antique Blue	EUR010 Forest
FOC026 Avocado	FOC025 Clover	FOC034 Magnolia	FOC007 Tobacco	EUR100 Black	EUR011 Mahogany
FOC001 Black	FOC035 Fawn	FOC125 Olive	FOC048 Teak	EUR009 Blackberry	EUR007 Patina Red
FOC030 Bone	FOC121 Garnet	FOC044 Orange	FOC102 Weiss	EUR008 Chestnut	EUR002 Snuff
FOC028 Camel	FOC104 Grey	FOC029 Parchment	FOC101 White		
FOC120 Campari	FOC103 Haze	FOC041 Persimmon	FOC126 Zeder		
FOC039 Caramel	FOC042 Honeydew	FOC047 Russet			
FOC146 Caribbean	FOC038 Indigo	FOC043 Saddle			
FOC037 Chateau	FOC012 Ivory	FOC031 Safari			

Arc Com Fabric Grading

For memo samples call Arc-Com at 800-223-5466

Grades and availability of fabric are subject to change without notice. Changes could include but are not limited to price increases, discontinued patterns, discontinued colors, etc. See jsifurniture.com for updated information.

Pattern	Grade	Pattern	Grade	Pattern	Grade	Pattern	Grade
Allegra	E	Fiore	G	Metro	I	Spectrum	D
Alpha	E	Fireflies	E	Mirror, Mirror	E	Spin	G
Analog	H	Forsythia	G	Monte Carlo	F	Spirit	D
Antigua	E	Francesca Wool	F	Moon Beam	E	Spot-On	F
Apex	G	Francesca Wool II	H	Moon Beam 2	E	Spotlight	G
Arashi	F	Frontier	C	Morocco	F	Spring	G
Astral	F	Galaxy	E	Murano	G	Spyro	F
Atomic	H	Gamma	E	Mystique	E	Stonehenge	G
Aurora	F	Gardenia	F	Navigator	F	Strand-It	G
Axis	F	Gatsby	D	Network	G	Strata	D
Bauble	F	Gem	D	Niagara	F	Streamline	D
Beat Box	G	Geostitch	F	Nova	G	Symphony	G
Block Party	G	Glimmer	E	Oasis	F	Tally	E
Bloom	G	Grand Central	E	Odyssey	E	Tango	F
Blossom	G	Grid	F	Ombre Petal	F	Tectonic	F
Boardwalk	E	Harlequin	G	Omega	E	Tempo	F
Bounce	G	Highlands	F	Orion	D	Terrain	D
Bourbon Street	F	Hopscotch	G	Pala	F	The Plaid	I
Brayer Flower	F	Hush	E	Palatine	E	Theory	C
Bronco	E	Iguana	E	Palatine 2	E	Trio	F
Bubbly	G	Illusion	C	Panache	E	Tritik	F
Campus Stripe	F	Illusion 2	C	Pebble Beach	D	Uptown	H
Candy Land	G	Intaglio	E	Pinball	E	Urban	G
Carnival	E	Intaglio 2	E	Pinpoint	E	Velocity	F
Casablanca	G	Intersect	E	Plateau	D	Vineyard	F
Cascade	F	Isabella	D	Polo	F	Vista	D
Cassio	E	Itajime	F	Posh	F	Volley	F
Channel	E	Jardin	H	Prism	C	Volt	J
Chit-Chat	E	Jing	E	Quad	F	Wonderland	G
Chroma	E	Jive	F	Radiant	G	Yoyo	H
Cirque	G	Juliet	I	Radius	G	Zipline	F
Clarion	F	Katano	E	Ravenna	F		
Coastline	E	Key	F	Rhythm	F		
Column	E	Kinetic	F	Ringling	F		
Compass	I	Kirigami	F	Riviera	G		
Constantine	H	Kumo	F	Robotic	F		
Contour	D	Laurel	G	Rodeo	D		
Crossroads	E	Leaflet	F	Roundabout	E		
Dakota	D	Legacy	E	Royal Garden	H		
Dakota 2	D	Leonardo	G	Sagrada	J		
Dazzle	G	Loara	F	Sahara	E		
Delphi	D	Lotus	F	Samba	F		
Delta	D	Luxe	E	Santa Fe	E		
Durango	C	Lyre	E	Savannah	F		
Dynasty	E	Lyric	G	Saxon	G		
Echo	G	Marathon	E	Sequoia	E		
Eclipse	F	Mason	F	Sherlock	D		
Empress	D	Masquerade	G	Shibori	G		
Etc.	F	Meadow	G	Shimmer	D		
Etch	E	Meridian	C	Shimmer 2	D		
Facet	J	Mesa	D	Silverado	D		

Designtex Fabric Grading

For memo samples call Designtex at 800-221-1540

Grades and availability of fabric are subject to change without notice. Changes could include but are not limited to price increases, discontinued patterns, discontinued colors, etc. See jsifurniture.com for updated information.

Pattern	Grade	Pattern	Grade	Pattern	Grade	Pattern	Grade	Pattern	Grade	Pattern	Grade
Acacia	G	Circolo	F	Henrik Small W/Knit	J	Metamorphosis	H	Rotary	I	Tweed Multi	D
Adler	E	Circumference	I	Backing	J	Metta	D	Rothsay	G	Urban Grid	G
Aggregate	F	Claire	I	Hexstripe	F	Microgrid	E	Rothsay with	H	Valanka	I
Ainsley	I	Closed Loop	F	Holmes	G	Migration	H	Backing	H	Valet	E
Aksel	F	Cobble	J	Honor Plus	I	Mingle	F	Rough & Ready II	F	Variant	I
Alcazar	E	Colorblock	G	Horizon	H	Mod	H	Round Leaves	I	Versed	D
Alchemy	E	Colorful Plaid	E	Hyphen	F	Modern Tweed	I	Rove	H	Vivid	D
Aleman	H	Concept	H	Inertia	H	Moderne	H	Rumeli	E	Volley	H
Alistair	G	Converge	G	Inga Small	I	Mohair Plus	J	Samba	H	Vox	F
Alpine	D	Cross Court	H	Inga Small W/Knit	J	Motif	F	Samba Otra Vez	H	W	F
Amaranth	H	Crosshatch	G	Backing	J	New Selkrik	H	Saugatuck	F	Westside	I
Amuse	I	Crossweave	D	Inkling	F	Nexus	H	See Saw	H	Whim	F
Annex	F	Crosswind	F	Inlet	F	Noble	D	Seed	G	Windowpane	E
Appleseed	F	Culebra	I	Inside Edge	F	Nonchalant	E	Sett	I	Winsome	E
Argiano	E	Current	F	Interlock	G	Notion	G	Shibori Stripe	G	Wire	J
Array	I	Cusco	I	Introvert	E	Omar	E	Shimmering Tide	H	Woodcut	F
Arthur	I	Cut & Paste	I	Irregular Grid	E	Ophidian	F	Signal	I	Wren	D
Aster	I	Dahlia	H	Isometry	H	Opulent	D	Singing In The Rain	D	Yoruba	G
Astrid	E	Dart	G	Isotope	F	Oscillate	G	Skye	H	Yucca	F
Banda	G	Dashing	D	Jaunt	I	Oxford Stripe	H	Sorano	D	Zhuba	F
Baratto	G	Delaine	F	Journey	I	Palomino	E	Spandau	E	Zocalo	H
Barque	J	Dharma Stripe	E	Kabuki	F	Parga	E	Spiro	G		
Battista	I	Dichotomy	H	Kalahari	E	Pennington	I	Splendor	D		
Bee	D	Dot To Dot	G	Klange	F	Phase	F	Stacks	H		
Beetled Linen	H	Draft	F	Komposition	F	Pigment	G	Starburst	G		
Beguiled By The Wild	G	Eastside	I	Lambert	G	Piiki	H	Steppe	E		
		Ellipsis	C	Lattice	H	Pika	E	Striae	E		
Big Dot	F	Eon	F	Leaf Dot	F	Pinball	I	Sugar Shoots	H		
Billiard Cloth	F	Epiphany	F	Leafette	E	Pivot	E	Swayed	J		
Billiard Panel	E	Essence	C	Leap	F	Pleat	F	Swing	J		
Birch Bark Plaid	H	Faux Sure	F	Leaves	G	Pop Art	H	Swing Set	G		
Bit	E	Florin	F	Leland	F	Porte	F	Synthesis	I		
Block Print	H	Flux	G	Linari	D	Posey	H	Tack Cloth	F		
Bolt	F	Fortuna	H	Lindos	F	Prairie	E	Tarascon	D		
Bordo	H	Friendly Faux	F	Lioret	F	Precision	F	Terrain	G		
Botanique	E	Fuse	G	Little Dot	F	Prime	D	Tesellate	I		
Boucle	F	Gale	E	Little Plaid	E	Quintessence	G	Tetris	J		
Boucle Two-Tone	E	Gallone	F	Lofty	D	Radar	F	The Last Aphid	I		
Bounce	H	Gamut	C	Lolland	I	Rail	H	Tinos	G		
Breena	E	Glaze	F	Loop To Loop	H	Razor Stripe	H	Tiny Herringbone	F		
Bunta	F	Gleam	F	Lorien	G	Refine	D	Titanium	H		
Caiman	E	Gradate	G	Ludington	C	Restore	F	To The Point	E		
Cascadia	E	Gramercy	J	Luster	F	Reuse	G	Tombolo	E		
Catalyst	F	Grandeur	D	Lydia	I	Rice	F	Top Spin	I		
Cestino	G	Griglia	F	Maglia	H	Rio Grande	F	Trace	J		
Chapiteau	E	Hashtag	E	Mandala	F	Rivergrass	F	Tramway	G		
Checker Stripe	I	Heather	G	Margin	I	Rivet	E	Transport	H		
Chevron	J	Hem Stitch	E	Match Point	I	Rivet Pearl	E	Travertine	E		
Chromatic	E	Henrietta	I	Melange	E	Rocket	D	Tumble Stones	H		
Circa	F	Henrik Small	I	Melrose	I	Rosairo	I	Tumbleweed	F		

Maharam Fabric Grading

For memo samples call Maharam at 800-645-3943

Grades and availability of fabric are subject to change without notice. Changes could include but are not limited to price increases, discontinued patterns, discontinued colors, etc. See jsifurniture.com for updated information.

Pattern	Grade	Pattern	Grade	Pattern	Grade	Pattern	Grade	Pattern	Grade
Abacus	J	Coincide High	G	Hero by Kvadrat	F	Pick	C	Strum	F
Abacus Standard	G	Performance	G	Houndstooth	I	Pick Crypton	F	Sudden	F
Acre	F	Colline by Kvadrat	F	Hum	E	Pitch	E	Surge	F
Across*	G	Colorwheel	I	Inlay 466353	I	Plait	F	Tailor	F
Akimbo	F	Column	H	by Hella Jongerius	I	Plait High Performance	G	Tally	G
Align	F	Commentary	F	Insignia	H	Plural	J	Tandem	G
Alloy	E	Compound	F	Instill	E	Ply Mesh Black/Tan	J	Teatro	H
Alpaca Herringbone	J	Confetti	J	Jacobs Coat	J	Pocket	G	Technic	C
Alter	F	Cotton Velvet	J	Kindred	H	Point	J	Tend	F
Anagram	I	Couple	H	Knot	I	Quatrefoil	J	Terrace	F
Arabesque	I	Cover	F	Lariat	E	Quick	E	Ticker	G
Aria	I	Crew	H	Latch	J	Radiant	J	Tilt	G
Array	G	Crosspatch	J	Ledger	E	Recollection	F	Tokyo by Kvadrat	H
Article	D	Crush	F	Lens	G	Reel	H	Tonica by Kvadrat	F
Balustrade	I	Cursive	J	Lift	G	Regatta	J	Tonus by Kvadratt	G
Banister	H	Cycle	F	Lineage	F	Remix by Kvadrat	F	Tonus Meadow	G
Bar	C	Dapper	E	Link	G	Repeat Dot Ring	J	by Kvadrat	G
Bar Crypton	F	Dart	G	Manner	C	Ring	G	Toostripe	J
Basel by Kvadrat	F	Dash	F	Marquee	E	Rise	I	Trait	F
Before	F	Decode	G	Matrix by Kvadrat	H	Rove	F	Transport	I
Beside	F	Defer	E	Meander	G	Rubric	F	Tread	G
Bevel	E	Design 9297	J	Mechanism	H	Rule	G	Treat	G
Bitmap	J	Disc	C	Medium	C	Runner	G	Trellis	I
Blip	H	Disc Crypton	F	Melange Tweed	I	Runner Standard	E	Tremor	F
Blumen	J	Disperse	H	Meridian	F	Salon	H	Trio	J
Bound	E	Ditto	G	Messenger	C	Scape	G	Turn	H
Boundary	F	Divide	C	Metric	C	Schema	F	Twice	F
Bridge	E	Divide Crypton	F	Micro	E	Scout	F	Twine	F
Bright Angle	H	Divina by Kvadrat	G	Mikado	J	Scribe	F	Unisol	J
Bright Cube	H	Divina MD by Kvadrat	G	Milestone	C	Scuba	E	Urban	H
Bright Grid	H	Divina Melange by	G	Mimic	G	Seam	F	Vary	E
Brim	G	Kvadrat	G	Mineral	F	Semblance	C	Vases by Hella	I
Candid	E	Division	E	Minicheck	I	Sequence	F	Jongerius	I
Canvas by Kvadrat	F	Double Triangles	I	by Alexander Girad	I	Shadowbox	G	Velvet Stripe	J
Cartouche	F	Ellipsis	F	Minimal	F	Sheen	F	Venn	G
Centric	I	Emblem	G	Mister	H	Shuttle	G	Vestige	H
Certain	F	Emboss	F	Mode	D	Shuttle Standard	E	Vineyard	I
Chalet	F	Emmesh	F	Mohair Supreme	J	Signal	F	Voyage	I
Chance	G	Exchange	E	Molly by Kvadrat	F	Silk Canvas	I	Waterborn by Kvadrat	I
Checker by Alexander	I	Facets	I	Monk's Wool	J	Skein	E	Waxen	D
Girard	I	Fasten	H	Mortise	G	Slant	F	Wedge	J
Checker Split	J	Fathom	F	Oblique	C	Small Dot Pattern	J	Weimar	H
Chenille Cord	G	Feature	F	Octave	J	Snap	J	Whirl	F
Chenille Stripe	I	Fiddle	H	Offset	G	Soft Tweed	I	Wool Rib	I
Chime	E	Floret	G	Omen	F	Sort	I	Wrap	J
Chock	G	Fluent Crypton	F	Optik	J	Stack	E		
Cinch	D	Fluted Silk	I	Orakelblume	J	Star by Kvadrat	H		
Cipher	H	Focus	E	Ottoman Stripe	J	Stature	F		
Circles	J	Fraction	G	Outback by Kvadrat	G	Steady	E		
Circuit	G	Fruit by Hella Jongerius	J	Parched Silk	I	Steady Crypton	F		
Coach Cloth	I	Garden	I	Park	J	Steelcut by Kvadrat	G		
Cobblestone	J	Glint	E	Pavement	I	Steelcut Trio	G		
Coda by Kvadrat	I	Grade	H	Paver	F	by Kvadrat	G		
Coin	C	Hallingdal by Kvadrat	G	Pebble Wool	J	Strand	G		
Coin Crypton	F	Hedge	F	Pebble Wool Multi	J	Stride	G		
Coincide	E	Helix	H	Pennant	H	Stripes	J		

Mayer Fabric Grading

For memo samples call Mayer at 800-428-4415.

Grades and availability of fabric are subject to change without notice. Changes could include but are not limited to price increases, discontinued patterns, discontinued colors, etc. See jsifurniture.com for updated information.

Pattern	Grade	Pattern	Grade	Pattern	Grade	Pattern	Grade	Pattern	Grade
Acclaim	D	Daydream	D	Holiday	E	Obi	F	Silk Screen	C
Align	C	Dazzle	D	Hombre	E	Obsession	G	Silverweave	D
All Seasons FR	C	Debonair	G	Hoopla	D	On The Spot	G	Skate	D
All Use FR	C	Debut	F	Hopsack	E	Optic	C	Sketch	C
Amadeus	G	Destiny	D	Illusion	G	Orbit	D	Slick	D
Antique	D	Destiny plus	E	Images	D	Origami	F	Smart Suede	D
Apex	C	Durablock™	E	Impulse	D	Ottoman	F	Social Network	E
Arabesque	E	Detail	E	In The Groove	D	Outback	C	Solaris	F
Aristocrat	D	Disco	E	Infinity	G	Oxen SP Black	A	Soleil	F
Array	F	Dublin Tweed FR	D	Interlace	D	Palermo	D	Solid Ground	E
Artistry	C	Durango	C	Interlochen	D	Panache	G	Sophisticate	C
Ascension	G	Duraweave® 10	B	Intrigue	D	Paparazzi	F	Source	D
Athens FR	D	Echo	D	Jekyll & Hyde	C	Pastime	E	Source plus	E
Atomic	C	Ecosphere	F	Jenga	E	Patent	E	Durablock™	E
Aurora	G	Eleanor Rigby	F	Jitterbug	E	Patio	C	Spacer Mesh	B
Avenue	F	Element	C	Journey	E	Pavilion	F	Spirograph	D
Awakening	H	Empire	I	Jubilee	D	Peerless	C	Spotlight	F
Banner	C	Emu	C	Juncture	H	Phoenix	C	Stanza	E
Bar None	E	Encore	F	Karma	F	Pinehurst	D	Stop & Go	F
Batik	C	Enigma	G	Katagami	J	Pinnacle	D	Stratosphere	H
BeBop	F	Entourage	F	Key Largo	C	Plaza	D	Suede	D
Bella	F	Entwine	D	Kismet	F	Portal	E	Swank	F
Berkshire	D	Equation	D	Kobe	C	Positive Thoughts	G	Synapse	F
Big Top	F	Equinox	D	Komodo	D	Prado	D	Tangled Web	G
Blocks	C	Erode	G	Laredo	E	Primo	D	Theory	C
Bolero	D	Escapade	G	Linen	C	Prism	C	Time Line	E
Botanica	F	Esprit	D	Links	D	Pulse	F	Toss Up	D
Boteh	J	Essex	D	Locomotion	D	Punch	C	Tributary	D
Brio	E	Europa	E	Longhorn	D	Quark	F	Turnabout	G
Bungalow	I	Evolve	G	Lunar	E	Quattro	B	Tussah	D
Burst	E	Facets	F	Madras	E	Rain Dance	E	Twister	E
Camelot	E	Factor	D	Madrid SP Black	A	Ranchero	A	Uptown	C
Canvas	E	Fairy Tales	G	Makore	F	Rapport	C	Valet	C
Caressa FR	C	Fanfare	F	Malibu	D	Ratio	F	Variant	C
Caressa Suede	C	Fantasy	F	Mandala	H	Razzmatazz	F	Venetian	H
Cascade	D	Fathom	E	Marquise	C	Realm	F	Venue	D
Catalyst	D	Figure Eight	C	Marvel	F	Rebound	F	Verona	C
Cavalier	C	Finale	D	Matrix	G	Reiki	F	Vibrant	D
Cayman	F	Finesse	C	Maverick	C	Relic	F	Viewpoint	F
Celtic	E	Finish Line	E	Maze	F	Replay	F	Vintage Mohair	I
Chaps FR	C	Flock	G	Meander	D	Reveal	D	Vinyl Stat ESD	D
Charade	G	Florentino	C	Melody	E	Reverb	C	Vogue	E
Charette	E	Flower Power	D	Metro	D	Rhythm	G	Volante	H
Circuit	H	Focal Point	C	Microdot	C	Rift	D	Wallaby SP Black	A
Circumference	G	Forte	A	Milano	D	Rock & Roll	F	Webscape	D
Collage	G	Foundation 10	B	Monogram	D	Round 'N Round	F	Whimsy	G
Component	D	Gala	F	Moonscape	C	Sakura	G	Wildflower	G
Contempo	C	Geisha	G	Mosaic	D	Samurai	F	Willow	E
Continuum	C	Genesis	C	Mosaic plus	F	Sashiko	G	Wool Boucle	G
Cork	E	Genesis plus	D	Durablock™	F	Sequel	B	Xanadu	G
Counterpoint	D	Durablock™	D	Motif	G	Sequel plus	D		
Cross Check	B	Glee	D	Myriad	F	Durablock™	D		
Crystals	D	Glimmer	E	Mystic	C	Sequence	C		
Cuddle Up	F	Groundworks	F	New Dimensions	G	Shantung	D		
Curlicue	C	Guardian	C	Nirvana	G	Sherlock	C		
Dakota	C	Haberdash	C	Nostalgia	D	Shibori	F		
Dande	E	Habitat	E	Nuance	E	Shimmer	E		
Dapper	C	Hole In One	F	Nylon-Stat ESD	E	Sierra SP Black	A		

Momentum Fabric Grading

For memo samples call Momentum at 800-366-6839

Grades and availability of fabric are subject to change without notice. Changes could include but are not limited to price increases, discontinued patterns, discontinued colors, etc. See jsifurniture.com for updated information.

Pattern	Grade	Pattern	Grade	Pattern	Grade	Pattern	Grade	Pattern	Grade
Ace	C	Cycle	D	Impact	D	Ohs II	G	Silica Leather	F
Acoustic	F	Dash	F	Imperial Mohair	J	Ona	I	Silica Reach	G
Agora II	D	Dayspell	H	Index	G	Origin	A	Silica Roam	G
Aldo	G	Decode	C	Infinity	B	Ozone	H	Silica Stride	G
Align	I	Delano	G	Infusion	F	Pace Crypton	E	Silica Tech	F
Allegory	I	Delve	I	Inner Circle	H	Pace Incase	D	Silica Waltz	G
Amenity II	G	Dive	F	Insight	A	Panorama	J	Silk Struktur	H
Amuse	D	Dividend	G	Interim	I	Parable	F	Sketching Air	G
April	F	Dogwood Leaves	E	Intermezzo	I	Parkside Crypton	F	Skip	C
Ardour II	H	Domain	F	Intermix II	D	Parkside Incase	E	Small Talk	G
Arrange	H	Drift	G	Intersect	C	Parterre	E	Solace	C
Ascend	E	Duo	F	Interval	B	Passages	I	Solo 2	D
Audio	G	Ebb	F	Isla	E	Perk	B	Soma	G
Audubon	H	Edison	H	Jardin	G	Photon	H	Sort	F
Avanti	H	Effloresce	H	Jest	F	Pierre	G	Span Crypton	E
Avenue	D	Elevate	I	Jitney	E	Ping	D	Span Incase	D
Axis	C	Elle	F	Juncture	H	Pique	D	Spin	G
Bandwidth II	F	Emanate	H	Keynote	D	Plus	F	Splendeur	J
Bangle	A	Embark	F	Kindle	F	Propensity	C	Starboard	F
Banter	H	Eon	C	Kindred	F	Prospect	D	Streamers	D
Basis	B	Essay	F	Kinney	D	Proviso	G	Strut	E
Beeline	C	Estrella	H	Knack	C	Proximity	G	Sublime II	C
Beep	E	Evolve	H	Kudos	G	Quirk	D	Substance	J
Bento	F	Expo	B	Lana	I	Raffia	I	Sway II	G
Bias	G	Feliz	G	Ledge	E	Rally	H	Symbol	I
Bloc	G	Felt	G	Lella	G	Rattan	I	Synergy	D
Boom II	D	Felt Melange	G	Lina	I	Recollection II	G	Syntax	C
Boxcar	G	Flection	G	Lineage	I	Redux	D	System	G
Bravo II	D	Fleet	E	Lineup	C	Rein II	D	Tactic	G
Brisk	G	Flow	G	Linq	I	Respite	C	Tesla	G
Buoy	G	Flux	G	Livia	J	Revolve	H	Tetra	D
Cairns	H	Focal	D	Lloyd	G	Riga	G	Tone	E
Cairo II	G	Foray	D	Lore	F	Rivet	D	Torque	H
Camber	F	Free	C	Loupe	I	Row	D	Tradition	B
Canter	C	Fringe	E	Lucio	H	Sail	H	Trefoil	I
Carlo	H	Fuse	A	Ludwig	G	Scan	I	Trove	H
Cashmere II	C	Gentry	H	Malmo	G	Scape	G	Turin	G
Catalogue	H	Geo	J	Mapping Ideas	G	Scrabble	C	Twist	G
Central	E	Golden Leaf Tree	E	Marathon	B	Scribe	D	Upside	G
Centric	F	Gradient 18	H	Marcel	H	Sense	E	Vario	D
Channel	E	Gradient 36	J	Medley	F	Sidebar Crypton	F	Veer	H
Chant	F	Gradient Solid	F	Mensa	H	Sidebar Incase	F	Velocity	D
Chipper	I	H2O	J	Method	G	Sidestep	F	Venue	D
Cinch	B	Habit	C	Millennium	B	Signet	I	Via	C
Cite	G	Hearsay	H	Mix	I	Silica	F	Viva II	E
Clang	D	Helm	F	Molto	H	Silica Andy	G	Vox	B
Classique	J	Hickory Leaf	D	Nagoya	H	Silica Breeze	G	Wander	F
Context	B	Hive	E	Neon	H	Silica Deflect	G	Waver	E
Core	B	Hue	C	Nifty	D	Silica Etch	F	Waypoint	C
Course	G	Hula	H	Nile	H	Silica Fiona	G	Weaving Palettes	F
Cover Cloth	C	Icon	D	Nimble	H	Silica Fritz	G	Whim	F
Crete	H	Idyll	G	Oath	E	Silica Hiatus	G		
Current	C	Illumina	I	Odyssey	B	Silica Hoop	G		

Pallas Fabric Grading

For memo samples call email www.pallastextiles.com

Grades and availability of fabric are subject to change without notice. Changes could include but are not limited to price increases, discontinued patterns, discontinued colors, etc. See jsifurniture.com for updated information.

Pattern	Grade	Pattern	Grade	Pattern	Grade
Abstract Chevron	F	Kwaart	G	Turtle Neck	G
Algorithm	F	Laced Up	E	Twine	D
Amari	F	Larkspur	G	Unraveled	E
Asha	F	Latifolia	G	Unspun	G
Aurora	F	Le Fleur	F	Urbanized	E
Basaltes	F	Line	F	Vespa	E
Bevel	F	Majolica	G	Whim	E
Bonnaroo	F	Marbles	F	Wonder Wheel	H
Boulevard	F	Meadowrue	F	Work Horse	F
Bounce	E	Melody Maker	F		
Busy Bee	H	Milano	G		
Carnivale	G	Modern Blaze	F		
Cell Theory	I	Mosaic	E		
Chakra	F	Off Track	E		
Chitra	E	On The Fringe	H		
Chroma	G	Painted Stripe	G		
Composition	G	Patina	E		
Criss Crossing	F	Perfect Pitch	F		
Curve	H	Petals	G		
Dapple	E	Ping Pong	E		
Deeply Rooted	H	Point	F		
Deflect	E	Polka Dotty	F		
Delphinium	G	Promenade	F		
Dot Dot Dot	G	Racy	F		
Field Play	G	Raku	F		
Flame	F	Ravenna	G		
Flexing Muscles	F	Reel To Reel	G		
Formula	G	Reverb	G		
Fortune Teller	F	Rooftops	G		
Fracture	G	Round	I		
French Crepe	F	Running Stitch	H		
Friendship Bracelet	E	Sandstone	D		
Gather	E	Seeking Truth	G		
Gene Pool	G	Sheepish	F		
Graph	D	Skip	E		
Grasmere	F	Solid Footing	E		
Grid	F	Spin Art	G		
Grill Cloth	G	Spontaneous	I		
Ground Breaking	F	Spot On	F		
H2O	F	Spun	E		
Hand-Woven	F	Stamped Out	I		
Heritage	E	Stereo Stripe	G		
Highway Patrol	E	Surface	E		
Hitch	F	Swing	F		
Holy Cow	E	Tempo	E		
Holy Cow Too	E	Terra	D		
Infinite Helix	G	The Burbs	F		
Inlay	F	Top Color	F		
Interlace	G	Transom	G		
Jacks	H	Trellis	H		
Karoke	F	Tulips	G		

Stinson Fabric Grading

For memo samples call Stinson at 800-841-6279

Grades and availability of fabric are subject to change without notice. Changes could include but are not limited to price increases, discontinued patterns, discontinued colors, etc. See jsifurniture.com for updated information.

Pattern	Grade	Pattern	Grade	Pattern	Grade	Pattern	Grade	Pattern	Grade		
Abacus	G	Channel	D	Flex	E	Liquid	E	Respite	F	Tendrill	D
Acadia Epingle	I	Chauncey	D	Flight	G	Makeover	G	Retrograde	D	Tessellate	G
Acanthus	H	Chi w/Agion	G	Flip Flops	G	Mali	G	Revolution	G	Tessuto	C
Ace	C	Chloe	F	Florentine	G	Malta	I	Revolve	H	Thicket	D
Acrobat	G	Chroma	E	Folio	G	Manchester	E	Rialto	C	Torus	F
Adirondack	F	Cielo	H	Fractal	F	Marimba	F	Riddle	D	Tracing	E
Aero	F	Cinnamon Blossom	H	Freehand	E	Marquetry	F	Rivera	F	Tranquility	H
Affinity	F	Cirque	E	Furrows	D	Martini	F	Rogue II	B	Transcend	C
Alchemy	E	Cirro	F	Fuse	C	Matrix	E	Rolling Stones	H	Trax	D
Alfresco	G	Citadel	C	Geodesic	G	Mesa	H	Salinas	I	Tribeca	C
Algiers	G	Clean Slate	D	GeoMet	E	Metro	D	San Simeon	G	True Path w/Agion	H
Alignment	G	Coco	F	Glacier	C	Mica	D	Satellite	D	Tuscan Hills	H
All American	B	Colden	F	Glisten	H	Mingle	F	Scintillate	G	Tweed	F
Aloha	H	Colorguard All	C	Gradation	E	Moccasin	C	Scout	C	Umbrian Rain	H
Apex.Crypton Revl	E	Seasons	C	Grand Sierra	C	Modena	F	Scribe	D	Up Tempo w/Agion	H
Arc	F	Comeback	G	Gravity	E	Monhegan	G	Script	D	Urban Grid	C
Archetype	E	Concentric	G	Grille	D	Montage	E	Seagrass	G	Valise	D
Arioso	E	Connect	C	Grove	G	Montana	C	Sebago	F	Vanish	H
Ascend	F	Continuum	E	Hands On	F	Moxie	F	Second Act	G	Vapor	F
Aspen	F	Core	C	Happy Hour	E	Mumbai	G	Sedona	H	Varati	I
Atlas	C	Cottonwood	G	Happy Tappy	I	Natural World	J	Sentry - HC	C	Vegas	C
Atmosphere	C	Courtyard	H	Haven	E	Naugaleather	C	Sequence	D	Velocity	E
Auberge	H	Cozy	E	Helix	H	Naugasoft	C	Shantung	C	Verdure - Envi	F
Aura	I	Cranbrook Loop	J	Hi-Fi	D	Neochrome III	C	Shift	C	Vermont	H
Avant	C	Criss Cross	C	Highlight	C	Nest	H	Sideline	E	Vibe	F
Balance Beam	G	Cruisin	H	Hive	D	New Hempstead	C	Silverado w/Agion	F	View	H
Bali	F	Crypton Suede	D	Horizons	H	Next Scene	F	Simplicity	C	Vineyard	I
Balustrade	H	Crystalline	G	Hot Spot	F	Nimble	F	Skyline	G	Vintage	H
Bambu-Envi	F	Curves Ahead	G	Hourglass	G	Nishiki	C	Sleek	D	Vision	C
Banyan	F	Cyma	H	Hudson	G	Nova	E	Sleeping Bear Dunes	F	Voltage	H
Bari	F	Daddy-O w/Agion	G	Hush	F	Now & Zen w/Agion	I	Smile	G	Volterra-Hc	H
Bass Line	G	Dakota	D	I Spy	H	Olympus	F	Smoothie	C	Vortexia	I
Beatbox	F	Dart	C	Impression	H	On The Money	F	Snuggle	E	Walk the Line	J
Beep Beep	G	Dash	D	Inside Track	D	Orbit	D	Solitaire	D	Whirl	G
Bespoke	E	Deflection	G	Interplay	F	Oscillate	I	Spark	J	Whisper	C
Bistro	C	Delphi	F	Interval	E	Outlander	D	Sphere	E	Whitney	F
Blip	C	Detail	G	Isabella	H	Oxford	C	Spindles	H	Willow Talk	H
Block Party	F	Deza	I	Jala	I	Pacifica	G	Spirit Millennium	C	Wink w/Agion	F
Bon Voyage	J	Diffusion	I	Jam Session w/Agion	I	Panorama	J	Splash	F	Wish	I
Bongo	H	Diva	D	Jambi Stripe	G	Park Avenue	F	Sprint	C	Wyatt	D
Breton	G	Dodgeball	G	Jasmine Screen	F	Patriot Plus II	C	Squire	E	Ybor	F
Brilliant	D	Double Time w/Agion	I	Jump w/Agion	I	Peninsula Mohair	I	Stat-Con	E	Ziggy	C
Bryant Park	C	Duet	E	Juxy	F	Perimeter	D	Stellar	D	Zodiac	D
Bubblerake	G	Dynasty	C	Kambala	I	Persuasion	E	Sterling w/Agion	F	Zoom	E
Budget Black	A	E'lan-HC	H	Kennebunk	F	Petals	G	Stipple	D		
Burkshire	C	Effervescence	F	Ketana	H	Pivot	C	Stitch In Time	D		
Calibration	F	Elderberry	G	Kilkenny Tweed	C	Polka	E	Straight and Narrow	G		
Calla	G	Eli	F	Kinetic	F	Portico	F	Strand	C		
Camino	H	English Pub	C	Knock Knock	I	Posh	E	Stratford	I		
Cannon Beach	H	Entrada	G	Kusari	D	Prisma	F	Sumatran Palm	H		
Canterbury	G	Equinox	F	Labyrinth	G	Profile	E	Summit	E		
Capreni	F	Excursion	E	Laredo	C	Promenade	E	Sunburst	G		
Carlisle	D	Expressions	C	Latitude	D	Queue	F	Sundance	E		
Casablanca	I	Facet	D	Lava	H	Radiance	H	w/Stakleen			
Cassidy	C	Fast Lane	D	Leaps & Bounds	F	Raffia	E	Sunswept	I		
Catalina	F	Fenestra	H	Lift	G	Rainier	C	Supersillyness	I		
Catalyst	C	Figment	H	Lindley Park	D	Rally	B	Swivel	G		
Catwalk	F	Finite	E	Line Dance	F	Raquette	G	Symmetry	H		
Celeste	J	Firefly	G	Links	G	Realm	E	Symphony Classic	C		
Chakra	H	Fizz	E	Linus	F	Refraction	C	Tender	H		



Ultrafabrics Fabric Grading

For memo samples at Ultrafabrics email charlotteakirby@yahoo.com

Grades and availability of fabric are subject to change without notice. Changes could include but are not limited to price increases, discontinued patterns, discontinued colors, etc. See jsifurniture.com for updated information.

<u>Pattern</u>	<u>Grade</u>
Brisa	E
Brisa Distressed	E
Brisa Fresco	E
Buffalina	E
Eco Tech	E
Hammered	E
Metro Tech	E
Patine	E
Raffia	E
Ultraleather	E
Ultraleather Fusion	E
Ultraleather Fusion Shimmer	E
Ultraleather Linen	E
Ultraleather Pearlized	E
Ultraleather Pony	E
Ultraleather Pro	F
Ultraleather Promessa	E
Ultraleather Uccello	E
Ultratech	E
Viva	E

Effective January 1, 2016 ▲

Wollsdorf Leather Grading

For memo samples call Wollsdorf at 336-884-5005

Grades and availability of leather are subject to change without notice. Changes could include but are not limited to price increases, discontinued patterns, discontinued colors, etc. See jsifurniture.com for updated information.

<u>Pattern</u>	<u>Grade</u>
Alpine	L2
Atlantic	L2
Euroglazed	L2
Finesse	L2
FOC Earth Black	L2
FOC Earth Colors	L2
Genoa	L2
Mammut	L1
Oslo	L2
Paloma	L2
Prima	L2
Pull Up	L2
Sattel	L2
Sedona	L2

Specification Tools

JSI products are manufactured to order and provide a multitude of options to address your individual customer needs. As you process your order do not forget to include all the necessary information to allow the order entry process to be completed. Please see the order checklist at the beginning of every series.

JSI Customer Service edits every order for complete information. If details are not included with the purchase order, Customer Service will contact you to answer these questions. If information is not completed in a timely manner it will delay the entry process and could effect your product delivery date. To avoid delay in order entry and potential delay in delivery of your order, please double check the line items to ensure all selections have been completed.

To ensure completion of details on your purchase order, electronic catalogs and specification tools have been developed to aid in the process. These electronic tools include:

20-20 GIZA Studio and 20-20 CAP Studio software offers state-of-the-art design, specification, photo-realistic rendering and three-dimensional visualization capabilities for configurable products in the commercial interior design markets. 20-20 GIZA Studio and 20-20 CAP Studio are available for all JSI Casegood and Seating products, in 2D and 3D graphics and the Specifier Catalog. Updates are made monthly reflecting any changes that occurred. To be sure the most up to date information is provided on orders, users of this software program are responsible to update their catalogs.

ProjectMatrix, Inc. offers a full software solution for the contract furniture industry. Their software can help you create space plans to specifications for ease of specifying our JSI Casegood and Seating product lines. Updates are made monthly reflecting any changes that occurred. To be sure the most up to date information is provided on orders, users of this software program are responsible to update their catalogs.

GSAdvantage is a Federal Government electronic catalog site offered to assist GSA customers in specifying and pricing JSI product. Listed at this site are all contract items and prices under GSA Contract # GS-28F-0030U.

Our JSI website jsifurniture.com provides many tools to assist in the design and order selection. Included in the site are downloadable images, typicals, product symbols, brochures, contact information, price lists, sales representative locations, warranty and environmental information.

GSA Terms and Conditions



Contract Holder

Contract # GS-28F-0030U

In addition to the standard terms and conditions, the following terms and conditions apply to GSA contract.

Contract Number

GS-28F-0030U

Contract Period

September 23, 1999 - June 24, 2018

Statement of Intended Use

The furniture covered by special item numbers 711-8, 711-9, 711-11, 711-16, 711-17, 711-18, 711-19, and 711-95 is intended for use by Government executives (or equivalent military rank) in the executive, judicial, and legislative branches or armed forces of the federal government. To help customers make a good purchasing decision based on their needs and budget, GSA has established four grades of furniture: Grade (1) includes furniture that tends to be the most expensive on this schedule, Grade (2) furniture tends to be more moderately priced and Grades (3) and (4) furniture tend to be affordable pricing when compared to grades (1) and (2). The ordering agency or service is responsible for determining furniture appropriate for use in its offices which will fit within budget and comply with applicable federal or internal agency procurement regulations.

Description of Special Item Numbers SIN#

711-8	Executive office furniture
711-9	Executive conference room furniture
711-11	Tables, occasional and conference
711-16	Upholstered seating
711-17	Multiple seating
711-18	Multi purpose seating
711-19	Stacking chairs and dollies
711-95	Installation services (not to exceed 12% of net prices for projects where installation costs are \$500 or less.) Installation costs over \$500 are negotiated on a case by case basis.

Maximum Order

711-8	\$500,000 (five hundred thousand dollars) net
711-9	\$500,000 (five hundred thousand dollars) net
711-11	\$500,000 (five hundred thousand dollars) net
711-16	\$300,000 (three hundred thousand dollars) net
711-17	\$200,000 (two hundred thousand dollars) net
711-18	\$200,000 (two hundred thousand dollars) net
711-19	\$200,000 (two hundred thousand dollars) net
711-95	\$150,000 (one hundred fifty thousand dollars) net

Minimum Order

\$100 (One hundred dollars) net

Geographic Coverage

48 contiguous states and Washington D.C.

Business Size

Large Business

Point of Production

Ferdinand, Dubois County, Indiana
 French Lick, Orange County, Indiana
 Jasper, Dubois County, Indiana
 Paoli, Orange County, Indiana

Pricing

All prices shown are list prices (freight included)

Discount

Discount 61.6%* off list.

*Discount for CaseWorks, Reflections, Walden and Wellington is 61.71% off list.

Quantity Discounts

Not applicable.

Prompt Payment Terms

1% 15 - net 30 days from date of invoice.

Government Commercial Credit Cards

Accepted. No additional discount offered.

Foreign Terms

Not applicable.

Delivery Time

30-75 days after receipt of order, 90 days maximum.

Overnight and 2-day Delivery

Not applicable.

Urgent Requirements

Contact Customer Service if faster delivery is required.

F.O.B. Points

F.O.B. destination, freight prepaid and allowed to 48 contiguous states and Washington D.C. excludes special delivery requirements.

Ordering Address

JSI
 Attn: Participating Dealer
 225 Clay Street
 Jasper, IN 47546
 Fax: 812-482-1548
 Phone: 800-457-4511
 Email: orders@jaspergroup.us.com

Product Modifications

We willingly accept customers' modifications to standard products. See product modifications information by series at the start of each series under the "Product Modification" sections. If there is a modification you desire that is not listed in this section, please call Customer Service for a modification quote/price.

GSA Terms and Conditions

Payment Address

JSI
PO Box 231
Jasper, IN 47547-0231

Warranty Provision

JSI's commercial 15[▲] year warranty applies. See page 3.

Export Package Charges

Quoted on project-by-project basis.

Terms of Government Commercial Credit Card Acceptance

Accepted.

Rental, Maintenance, and Repair

Not applicable.

Installation

Contact dealer or installation representative.

Repair Parts

Not applicable.

Service and Distribution Points

National distribution.

Participating Dealers

Contact JSI customer service at 800-457-4511.

Preventive Maintenance

Not applicable.

Environmental Attributes

JSI is committed to protecting the environment. For JSI's complete environmental information, contact the GSA Customer Service at 800-457-4511. Go to jsifurniture.com for additional information.

Duns

00-636-7767

Notification Regarding Registration in SAMS Database

Name: Jasper Seating Company, Inc.
Cage code: 31881

Acceptance, Modification, Assignment

By placing this order for furniture, material or other products (sometimes collectively referred to as "goods"), customer agrees to these terms and conditions which shall prevail over inconsistent provisions in any other form or document of customer. No change or modification shall be applicable unless set forth in writing and signed by company. Neither this order nor any interest therein shall be assigned by customer except with the prior written consent of company.

Payment

Customer agrees to pay to company the amount indicated on the invoice, 1% 15 days, net 30 days from date of invoice (U.S.funds only), for goods ordered. Interest will be charged after 30 days from the date of invoice at the rate of one and a half percent (1.5%) per month. International sales will require additional payment arrangements. No goods shall be sold on consignment or conditional sales basis. Payment for the goods delivered hereunder shall constitute acceptance thereof.

Attorneys' Fees

Customer shall be responsible for all expenses and cost in connection with the enforcement by company of these terms and conditions and the cost of collection (including the fees of any collection agencies to whom the customer's account may be referred), plus reasonable attorneys' fees (which attorneys' fees shall not be less than 25% of the amount due, unless a lower amount is specified by applicable law).

Remedies

The remedies herein reserved shall be cumulative, and additional to any other or further remedies provided in law or equity. No waiver of a breach of any provision of these terms and conditions shall constitute waiver of any other breach or of such provision.

Insolvency

Company may forthwith cancel this order in the event of the happening of any of the following or any other comparable event: insolvency of the customer, the filing of a voluntary petition in bankruptcy, the filing of any involuntary petition to have customer declared bankrupt provided it is not vacated within thirty (30) days from the date of filing, the appointment of a receiver or trustee for customer provided such appointment is not vacated within thirty (30) days from the date of such appointment, or the execution by customer of an assignment for the benefit of creditors.

Limitation of Liability

The Company shall not under any circumstances be liable to the customer, owner of the goods or any third party for special, indirect, incidental, or consequential damages, including, without limitation, loss of profits or revenues, loss or damage to other property or equipment, cost of capital or of purchased or replacement goods, or expense, delay, or inconvenience cause by or arising from the purchase, sale, use, repair or inability to use the goods or by any performance or non-performance under, or breach of, these terms and conditions. The Company's sole liability for any defective goods shall be its repair or its replacement pursuant to the express warranties set forth above, or if amended, as applicable at the time of manufacture or repair of the goods. Some states do not allow the exclusion or limitation of incidental or consequential damages, so the above limitations or exclusion may not apply to all customers. Any action resulting from any breach on the part of company as to the goods or services delivered here under must be commenced within one year after the cause of action has occurred.

Returns and Allowances

Reasonable touch-up and deluxing is the dealer's responsibility. The Company will not make allowances for trip or delivery charges, but will only make allowance for actual work performed to correct manufacturing defects. Allowances may be authorized only by a company officer. It is the responsibility of the field sales representative to inspect any defective merchandise and make suggestions and recommendations as to the proper disposition. Field personnel cannot obligate or bind the company by definite agreement, without final authorization by a company officer. Company will not accept automatic charge backs which do not have prior authorization. All defects must be called to the company's attention upon arrival at the customer's "ship to" destination. To initiate any type of claim or request for parts, it is imperative to have the model number or fabric number, which may be located on the tag attached to the frame of the unit. Authorization for return to the company via a return goods authorization. Company will not issue credit allowances for any repairs without company's prior consent. Under no circumstances shall the company accept COD (cash on delivery) returns, and any such shipment will be refused.

GSA Terms and Conditions

Security Agreement

The Company may require and customer shall grant a security interest in goods sold pursuant to any credit the company may extend to the customer.

Governing Law

All disputes between the parties, whether or not arising out of these terms and conditions, will be governed by the laws of the state of Indiana. Customer agrees to submit to the jurisdiction of and agrees all lawsuits relating to any disputes between the customer and the company will be brought only in a state court located in Dubois County, Indiana or the United States District Court for the Southern District of Indiana. The customer hereby waives the right to a trial by jury in any action, proceeding, claim, or counterclaim whether in contract or tort, at law or in equity, arising out of or relating in any way to these terms and conditions and all other disputes between the parties.

Mitigation

If the company repossesses the goods prior to payment by the customer of all amounts due hereunder, the company may sell the goods, as is, where is, free and clear of all rights of the customer at either public or private sales, and apply the net proceeds (after deducting expenses of repossession and sale) to the obligation of customer hereunder. The customer may dispose of the goods in any commercially reasonable place and manner and the customer waives any notice of time, place and manner of sale.

Integration

This order for goods, including these terms and conditions, along with any credit application, invoice, statement, dealer contract, acknowledgment, bill of lading (and any exhibits, addenda or amendments thereto) of which this order may be a part, constitutes the sole and complete agreement between the company and the customer with respect to the purchase of the goods.

Dimensions/Specifications/Finishes

All dimensions are approximate and may vary due to the upholstery technique of each craftsman. If exact dimensions are required, it is necessary for the customer to state such specifications with the order. Detailed specifications sheets are available for each series of goods, and customer should consult the company's customer service department for these specification sheets. Company reserves the right to make changes in dimensions, style, or specifications if company believes these changes will improve the goods' quality or appearance. Company reserves the right to substitute hardwoods due to availability at production. Due to the natural characteristics of wood, environmental effects, and material upgrades, the company cannot guarantee exact finish matches on existing goods previously ordered from company. If an exact match to customer's existing goods is required, it must be specified so that the proper procedures can be followed to ensure an acceptable finish. Company will accept no liability for the finish if this procedure isn't followed. Company reserves the right to make changes in a finish formula if company believes the change will improve the quality or appearance of company's goods.

Company's Performance of Its Obligation

The production and delivery of the goods to the extent delayed or hindered or prevented from the performance by reason of natural disasters, acts of god, strikes, lockouts, labor troubles, inability to procure materials, casualties, failure of power, restrictive governmental laws or regulations, riots, insurrections, acts of terrorism, war or other reason of a like nature not the fault of the company shall excuse for the period of the delay the company's performance and the period for the performance shall be extended for a period equivalent to the period of such delay.

Swivel Seating Overview



Anthem 28



Avia 31



Cabaret **NOW!** 37



Harbor 39



Madison **NOW!** 41



Newton **NOW!** 45



Portrait 48



Protocol **NOW!** 51



Proxy 58



Tara 61



Tyler **NOW!** 68



Waltham 71

Swivel Seating Specifications (Unique features for a model will be cited on the price pages for that model).

Rights and Lefts

The handedness of the chair is determined by seated position.

Exterior Wood Materials

All solid lumber materials used in our swivel seating are kiln dried from suppliers practicing forest sustainability. Any defects in the wood that are removed during our process are utilized in other areas of production.

Wood Arms and Base Caps are profiled or carved to shape out of solid lumber which complement our casegood product lines.

Interior Frame Materials

A combination of materials are used to create interior frame components, including solid lumber, plywood, metal plates, and high grade upholstery board.

Some of our swivel seating is made of plywood shell construction. These shells are layers of hardwood veneers molded and cured to shape. Shells can contain one or two pieces.

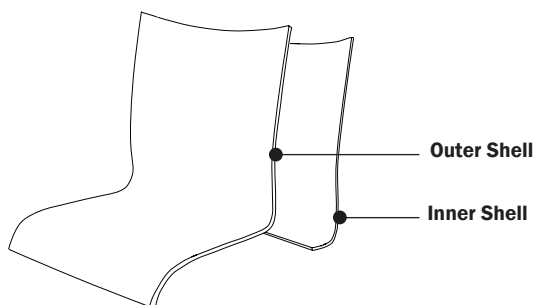

Construction

Tenon style joinery is used in most frame construction for our seating products; however, dowel pin joinery may also be used. Engineering will determine, based on design which joinery is best for the frame of each particular design. Critical joints are reinforced with mechanical fastening.

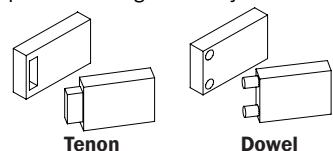

Upholstery Details

On frame seating, the webbing is applied to the frame, along with high resilience upholstery foam to create the seat foundation. The swivels with molded plywood, have a highly fabricated or molded foam which is applied directly to the plywood shell. This foam is contoured to the shell to create comfort and support, such as the back lumbar area. Arm and other frame members are covered with a high grade upholstery foam.

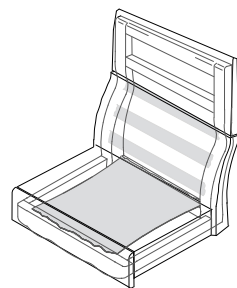

fabricated foam to the frame

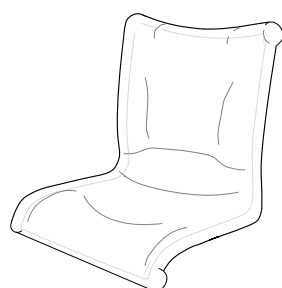

molded foam to shell

Finish

Each of the wood components that goes into a chair will have unique characteristic; the process of shaping and machining these parts may expose additional natural characteristics. To accentuate the beauty of the wood, special care is taken in selecting the frame component and base caps or each finish color.

Finish colors may vary slightly when comparing solid wood product finish to our casegoods veneer product finish. Exceptional care is taken to assure a uniform color on solid wood products.

Former finish names are listed in parentheses for reference.

Seating Finishes

ALE	Ale (Natural Maple)	FLX	Flax
AUB	Auburn (Windsor Mahogany)	LGC	Legacy (Legacy Cherry)
AUT	Autumn (Autumn Cherry)	MCH	Mocha
BRL	Barley	NTO	Night Owl (Vintage Walnut)
BBN	Bourbon (Natural Cherry)	PRL	Praline (Vintage Cherry)
BRG	Brighton (Brighton Cherry)	SAF	Saffron (Medium Cherry)
BUT	Butterscotch	SIE	Sienna
CIN	Cinnamon	TOF	Toffee
CLA	Classic (Classic Cherry)	TRF	Truffle
EAR	Earthy	VEN	Venetian (Dark Mahogany)
ESP	Espresso		

Color Coordinates

Color Coordinate Finishes are intended to coordinate with select laminate and double cut veneer casegood finishes. They represent an average color and do not match the grain pattern of the coordinating laminate or double cut veneer.

CBE	Blonde Echo Coordinate	CHL	High Line Coordinate
CBZ	Brazilwood Coordinate	KKC	Khaki Coordinate
CCF	Coffee Coordinate	CST	Studio Teak Coordinate
CCR	Cremello Coordinate	CWH	Walnut Heights Coordinate
CGR	Graphite Coordinate		

Not all finishes are available in every seating series. Reference the Order Check List at the beginning of each series.

Protective Top Coat

We are proud that our finish is GreenGuard certified. To reduce hazardous formaldehyde emission we use our proprietary specially designed top coat, DuraTex™. Our DuraTex™ top coat offers exceptional hardness along with abrasion and impact resistance, but has been formulated to eliminate the hazardous and harmful gases that are normally associated with wood finish.

DuraTex™ Features

Safety - Significantly reduces hazardous formaldehyde emissions which help improve the quality of the of the indoor air we breathe.

Quality - Developed to be tough and durable with special attention to appearance. The DuraTex™ finish provides a safe solution and still preserves the natural beauty of wood.

Durability - Designed to meet a wide range of demanding performance and environmental standards to withstand even the highest wear and tear.

Swivel Seating Specifications (Unique features for a model will be cited on the price pages for that model)

Chair Mechanisms

Swivel Tilt

This mechanism provides for a balanced ride and for standard tilt travel. Tilt tension can be adjusted by the center knob.

Mid-Pivot Tilt

This mechanism provides a synchronized ride that cradles the occupant as they recline along with the ergonomic benefit of a reduced front seat rise. The tilt travel is greater than a standard swivel tilt and allows users to achieve a wide variety of positions. Center tension knob is a way of regulating spring force.

Full Synchronized Tilt

This unique mechanism configuration takes full advantage of seat to back synchronized ratio geometry and successfully combines the benefits gained from a forward-based pivot location. Two-piece, swivel tilt seating allows separate seat and back adjustment capability with a tension adjustable spring that offers reduced front edge rise. The tension spring gives the ability to maintain even support throughout the entire travel range, satisfying a variety of user sizes and weights.

Seat Slider

Some models have an option to provide additional seat depth with a seat slider mechanism working in conjunction with the tilt mechanism.

Height Adjustable Back

A mechanism installed in the back to allow lumbar region to be adjusted to the user needs.

Jury Base

A substitution for 5 star base, providing a platform that can be bolted to the building floor.

Some models offer the pneumatic lift jury base for height adjustment, this option is not self centering. The mechanical height adjustment option is self-centering.

Conference Height Mechanism

Replacing the pneumatic gas cylinder, this mechanism provides for a fixed seat height.

Upholstery Cover Application

Unless a customer specifies the fabric to be run "railroad", the fabric will be "cut up the roll". Additional seaming may be needed, pending fabric width and textile repeat match. Contact Customer Service with questions.

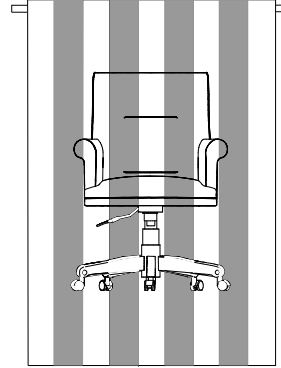

Care of Upholstery Surfaces

Cleanability will vary based on the fabric type. For best results, a professional service is recommended. Dirt and crumbs may be gently brushed or vacuumed off. Spills should be wiped up immediately with a cloth. Vinyl textiles can be cleaned with warm soapy water and wiped down with a warm damp cloth. For more details on any JSI carded fabric and vinyl, please visit our website at jsifurniture.com or consult the back of the appropriate swatch card for cleaning codes and any specific instructions. For COM materials, consult with the individual textile manufacturer for cleaning codes and any specific instructions pertaining to your particular fabric.

Care of Wood Edges and Veneer Surfaces

Clean all surfaces frequently with water dampened soft cloth, moving the cloth with the grain direction. Immediately remove any liquids that come in contact with wood surfaces, with a blotting action to absorb liquid. Buff dry. Lift objects to move them, never pull them across the finished surface. Avoid exposure of furniture to extremes of heat, cold, and wide variance of humidity. Avoid exposure of furniture to strong sunlight. Avoid exposure of furniture to harsh solvents such as nail polish remover, acetates, etc., as it will cause finish deterioration.

Wipe smooth powder coat finishes and textured metals with a damp cloth. For stubborn stains and grease marks, use soap and water. Lightly brush textured metals with a soft, dry brush to remove dirt.

Anthem Order Check List:



SWIVEL

Specify:

- 1. Model Number
- 2. Wood Species - Maple (M)
- 3. Wood Base/Arm Cap Finish
- 4. Fabric Selection - vendor, pattern and color
- 5. Base Selection - black polyurethane base standard
 - A. Wood Base - add \$98 list; specify wood finish
 - B. Polished Aluminum Base - add \$51 list
 - C. Black Jury Base - add \$164 list
- 6. Optional Black Polyurethane Arms - no upcharge

Example:

AN2805C (model #)	M (wood species)	AUB (finish) wood base/arm caps	MOMENTUM (fabric vendor)	VOX (pattern name)	MYSTIC (pattern color)
-----------------------------	----------------------------	--	------------------------------------	------------------------------	----------------------------------

1. Model Number

2. Wood Species - Maple (M)

3. Wood Base/Arm Cap Finish Options:

ALE Ale	FLX Flax
AUB Auburn	CGR Graphite Coordinate
AUT Autumn	CHL High Line Coordinate
BRL Barley	CKC Khaki Coordinate
CBE Blonde Echo Coordinate	LGC Legacy
BBN Bourbon	MCH Mocha
CBZ Brazilwood Coordinate	NTO Night Owl
BRG Brighton	PRL Praline
BUT Butterscotch	SAF Saffron
CIN Cinnamon	SIE Sienna
CLA Classic	CST Studio Teak Coordinate
CCF Coffee Coordinate	TOF Toffee
CCR Cremello Coordinate	TRF Truffle
EAR Earthy	VEN Venetian
ESP Espresso	CWH Walnut Heights Coordinate

4. Fabric Selection - Please supply the following:

- Fabric vendor
- Pattern name
- Pattern color

When specifying contrasting upholstery, indicate clearly which upholstery is to be applied to the seat, back and arms. Use higher grade pricing.

- Indicate direction of fabric - Railroaded or Up the Roll
- Please provide illustration, if available

All COM orders must include the following:

- Vendor's name, pattern name and color
- Sample of the fabric attached to order
- Model numbers of items for fabric application

- Special application instructions (e.g., all stripes will be applied front to back unless specified otherwise)
- Customer and purchase order number

Ship prepaid COM material to:
 JSI
 Attn: COM Dept
 932 Mill Street
 Jasper, IN 47546

Application of fabric:
 Railroaded Up the Roll

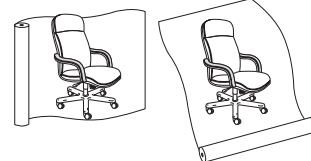

All COM orders will ship at standard lead time from receipt of COM except for orders requiring special custom matched finishes.

5. Base Selection - black polyurethane base standard

- A. Wood base - add \$98 list; specify wood finish
- B. Polished aluminum base - add \$51 list
- C. Black jury base - add \$164 list

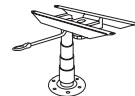

Pneumatic lift - NOT self-centering - Standard





Mechanical self-centering lift - MUST BE SPECIFIED

6. Optional Black Polyurethane Arms - no upcharge

- Models AN2805U and AN2800U standard with upholstered arm.
- Models AN2805C and AN2800C standard with upholstered arm with wood cap. Requires wood finish selection.

Description	Model	Specifications			List Price Per Grade	
Executive Swivel 	AN2805U • upholstered arm • overall height range is 43 1/2 - 48 1/2 • seat height range is 18 1/2 - 23 1/2 • arm height range is 28 - 33	Dimensions	D	W	H	COM \$1,357
		Overall	27	26 1/2	48 1/2	A \$1,384
		Seat	17 1/2	21	23 1/2	B \$1,439
		Arm			33	COL/C \$1,535
		Upholstery	Shipping			D \$1,656
		COM Ydg	3 1/8	Ctn Wt	56	E \$1,778
		COL Sq Ft	57	Cu Ft	19	F \$1,907
						G \$2,091
						H \$2,286
						I \$2,592
				J \$2,958		
				L1 \$2,128		
				L2 \$2,323		

Executive Swivel 	AN2805C • upholstered arm with wood cap • overall height range is 43 1/2 - 48 1/2 • seat height range is 18 1/2 - 23 1/2 • arm height range is 28 - 33	Dimensions	D	W	H	COM \$1,357
		Overall	27	26 1/2	48 1/2	A \$1,384
		Seat	17 1/2	21	23 1/2	B \$1,439
		Arm			33	COL/C \$1,535
		Upholstery	Shipping			D \$1,656
		COM Ydg	3 1/8	Ctn Wt	56	E \$1,778
		COL Sq Ft	57	Cu Ft	19	F \$1,907
						G \$2,091
						H \$2,286
						I \$2,592
				J \$2,958		
				L1 \$2,128		
				L2 \$2,323		

Management Swivel 	AN2800U • upholstered arm • overall height range is 38 1/2 - 43 1/2 • seat height range is 18 1/2 - 23 1/2 • arm height range is 28 - 33	Dimensions	D	W	H	COM \$1,314
		Overall	26	26 1/2	43 1/2	A \$1,340
		Seat	17 1/2	21	23 1/2	B \$1,393
		Arm			33	COL/C \$1,484
		Upholstery	Shipping			D \$1,602
		COM Ydg	3	Ctn Wt	51	E \$1,718
		COL Sq Ft	54	Cu Ft	14	F \$1,842
						G \$2,019
						H \$2,205
						I \$2,499
				J \$2,851		
				L1 \$2,053		
				L2 \$2,241		

To Order, Specify:

- 1 Model Number
- 2 Wood Species - Maple (M)
- 3 Wood Base/Arm Cap Finish
- 4 Fabric Selection - vendor, pattern and color
- 5 Base Selection - black polyurethane base standard
 - A. Wood Base - add \$98 list; specify wood finish
 - B. Polished Aluminum Base - add \$51 list
 - C. Black Jury Base - add \$164 list
(self-centering manual available - specify when ordering)
- 6 Optional Black Polyurethane Arms - no upcharge

3 Wood Base/Arm Finish Options:

- | | |
|----------------------------|-------------------------------|
| ALE Ale | FLX Flax |
| AUB Auburn | CGR Graphite Coordinate |
| AUT Autumn | CHL High Line Coordinate |
| BRL Barley | CKC Khaki Coordinate |
| CBE Blonde Echo Coordinate | LGC Legacy |
| BBN Bourbon | MCH Mocha |
| CBZ Brazilwood Coordinate | NTO Night Owl |
| BRG Brighton | PRL Praline |
| BUT Butterscotch | SAF Saffron |
| CIN Cinnamon | SIE Sienna |
| CLA Classic | CST Studio Teak Coordinate |
| CCF Coffee Coordinate | TOF Toffee |
| CCR Cremello Coordinate | TRF Truffle |
| EAR Earthy | VEN Venetian |
| ESP Espresso | CWH Walnut Heights Coordinate |

- 4 See a selection of graded fabric manufacturers and patterns on pages 12-20. Contact Customer Service for additional fabric options.

Specifications

- Wood species - Maple plywood arms
- Seat has two layers of plywood and 3 1/2" high density polyurethane foam.
- Back has two layers of plywood and 3 1/4" high density polyurethane foam.
- Arms have 1/2" polyurethane foam.
- Swivel models revolve, tilt, have tension control, pneumatic lift mechanism and black polyurethane base with black dual wheel casters.
- Constructed with one piece plywood outer shell, contoured for maximum comfort and matching interior seat and back plywood shells.

Description

1 Model

Specifications

List Price Per Grade

Management Swivel

AN2800C

- upholstered arm with wood cap
- overall height range is 38 ½ - 43 ½
- seat height range is 18 ½ - 23 ½
- arm height range is 28 - 33



Dimensions		D	W	H
Overall		26	26 ½	43 ½
Seat		17 ½	21	23 ½
Arm				33
Upholstery		Shipping		
COM Ydg	3	Ctn Wt	51	
COL Sq Ft	54	Cu Ft	14	

- COM \$1,314
- A \$1,340
- B \$1,393
- COL/C \$1,484
- D \$1,602
- E \$1,718
- F \$1,842
- G \$2,019
- H \$2,205
- I \$2,499
- J \$2,851
- L1 \$2,053
- L2 \$2,241

SWIVEL

To Order, Specify:

- 1 Model Number
- 2 Wood Species - Maple (M)
- 3 Wood Base/Arm Cap Finish
- 4 Fabric Selection - vendor, pattern and color
- 5 Base Selection - black polyurethane base standard
 - A. Wood Base - add \$98 list; specify wood finish
 - B. Polished Aluminum Base - add \$51 list
 - C. Black Jury Base - add \$164 list (self-centering manual available - specify when ordering)
- 6 Optional Black Polyurethane Arms - no upcharge

3 Wood Base/Arm Finish Options:

ALE	Ale	FLX	Flax
AUB	Auburn	CGR	Graphite Coordinate
AUT	Autumn	CHL	High Line Coordinate
BRL	Barley	CKK	Khaki Coordinate
CBE	Blonde Echo Coordinate	LGC	Legacy
BBN	Bourbon	MCH	Mocha
CBZ	Brazilwood Coordinate	NTO	Night Owl
BRG	Brighton	PRL	Praline
BUT	Butterscotch	SAF	Saffron
CIN	Cinnamon	SIE	Sienna
CLA	Classic	CST	Studio Teak Coordinate
CCF	Coffee Coordinate	TOF	Toffee
CCR	Cremello Coordinate	TRF	Truffle
EAR	Earthy	VEN	Venetian
ESP	Espresso	CWH	Walnut Heights Coordinate

- 4 See a selection of graded in fabric manufacturers and patterns on pages 12-20. Contact Customer Service for additional fabric options.

Specifications

- Wood species - Maple plywood arms
- Seat has two layers of plywood and 3 ½" high density polyurethane foam.
- Back has two layers of plywood and 3 ¼" high density polyurethane foam.
- Arms have ½" polyurethane foam.
- Swivel models revolve, tilt, have tension control, pneumatic lift mechanism and black polyurethane base with black dual wheel casters.
- Constructed with one piece plywood outer shell, contoured for maximum comfort and matching interior seat and back plywood shells.

Avia Order Check List:



SWIVEL

- Specify:**
- 1. Model Number
 - 2. Fabric Selection - vendor, pattern and color
 - 3. Contrasting Textile Center - see page 36 for upcharge

Example:

AI3612 (model #)	MOMENTUM (fabric vendor)	VOX (pattern name)	MYSTIC (pattern color)
----------------------------	------------------------------------	------------------------------	----------------------------------

1. Model Number

2. Fabric Selection - Please supply the following:

- Fabric vendor
- Pattern name
- Pattern color

When specifying contrasting upholstery, indicate clearly which upholstery is to be applied to the seat and back. Use higher grade pricing.

- Indicate direction of fabric - Railroaded or Up the Roll
- Please provide illustration, if available

All COM orders must include the following:

- Vendor's name, pattern name and color
- Sample of the fabric attached to order
- Model numbers of items for fabric application
- Special application instructions (e.g., all stripes will be applied front to back unless specified otherwise)
- Customer and purchase order number

Ship prepaid COM material to:
 JSI
 Attn: COM Dept
 932 Mill Street
 Jasper, IN 47546

Application of fabric:
 Railroaded Up the Roll

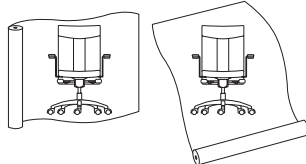

3. Contrasting Textile Center - see page 36 for upcharge

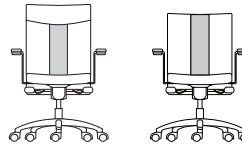

All COM orders will ship at standard lead time from receipt of COM except for orders requiring special custom matched finishes.

SWIVEL

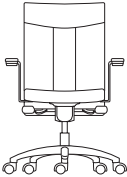
Description	Model	Specifications	List Price Per Grade																												
Executive High Back Swivel 	AI3612 <ul style="list-style-type: none"> · fixed back · Arctic Silver open arms with textured pad · Arctic Silver powder coated base standard; black nylon base available, no upcharge · seat slider · synchro-tilt mechanism · 21 degrees of tilt travel · 5 position tilt lock with anti-kick-back safety feature · tension control with side activated, telescoping handle · gas assist lift · contrasting textile center, see page 36 for upcharge · seat height range is 18 - 22 ½ 	<table border="1"> <thead> <tr> <th>Dimensions</th> <th>D</th> <th>W</th> <th>H</th> </tr> </thead> <tbody> <tr> <td>Overall</td> <td>26</td> <td>26</td> <td>39 ⅞</td> </tr> <tr> <td>Seat</td> <td>19 ½</td> <td>18 ½</td> <td>22 ½</td> </tr> <tr> <td>Arm</td> <td colspan="3">26</td> </tr> <tr> <th colspan="2">Upholstery</th> <th colspan="2">Shipping</th> </tr> <tr> <td>COM Ydg</td> <td>2 ¼</td> <td>Ctn Wt</td> <td>67</td> </tr> <tr> <td>COL Sq Ft</td> <td>41</td> <td>Cu Ft</td> <td>18</td> </tr> </tbody> </table>	Dimensions	D	W	H	Overall	26	26	39 ⅞	Seat	19 ½	18 ½	22 ½	Arm	26			Upholstery		Shipping		COM Ydg	2 ¼	Ctn Wt	67	COL Sq Ft	41	Cu Ft	18	COM \$1,349 A \$1,369 B \$1,407 COL/C \$1,477 D \$1,564 E \$1,652 F \$1,746 G \$1,877 H \$2,018 I \$2,238 J \$2,502 L1 \$1,903 L2 \$2,044
		Dimensions	D	W	H																										
Overall	26	26	39 ⅞																												
Seat	19 ½	18 ½	22 ½																												
Arm	26																														
Upholstery		Shipping																													
COM Ydg	2 ¼	Ctn Wt	67																												
COL Sq Ft	41	Cu Ft	18																												

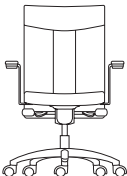
Executive High Back Swivel 	AI3614 <ul style="list-style-type: none"> · fixed back · Arctic Silver open arms with upholstered pad · Arctic Silver powder coated base standard; black nylon base available, no upcharge · seat slider · synchro-tilt mechanism · 21 degrees of tilt travel · 5 position tilt lock with anti-kick-back safety feature · tension control with side activated, telescoping handle · gas assist lift · contrasting textile center, see page 36 for upcharge · seat height range is 18 - 22 ½ 	<table border="1"> <thead> <tr> <th>Dimensions</th> <th>D</th> <th>W</th> <th>H</th> </tr> </thead> <tbody> <tr> <td>Overall</td> <td>26</td> <td>26</td> <td>39 ⅞</td> </tr> <tr> <td>Seat</td> <td>19 ½</td> <td>18 ½</td> <td>22 ½</td> </tr> <tr> <td>Arm</td> <td colspan="3">26 ⅞</td> </tr> <tr> <th colspan="2">Upholstery</th> <th colspan="2">Shipping</th> </tr> <tr> <td>COM Ydg</td> <td>2 ¼</td> <td>Ctn Wt</td> <td>63</td> </tr> <tr> <td>COL Sq Ft</td> <td>41</td> <td>Cu Ft</td> <td>18</td> </tr> </tbody> </table>	Dimensions	D	W	H	Overall	26	26	39 ⅞	Seat	19 ½	18 ½	22 ½	Arm	26 ⅞			Upholstery		Shipping		COM Ydg	2 ¼	Ctn Wt	63	COL Sq Ft	41	Cu Ft	18	COM \$1,394 A \$1,414 B \$1,453 COL/C \$1,522 D \$1,609 E \$1,697 F \$1,791 G \$1,922 H \$2,063 I \$2,283 J \$2,547 L1 \$1,948 L2 \$2,089
		Dimensions	D	W	H																										
Overall	26	26	39 ⅞																												
Seat	19 ½	18 ½	22 ½																												
Arm	26 ⅞																														
Upholstery		Shipping																													
COM Ydg	2 ¼	Ctn Wt	63																												
COL Sq Ft	41	Cu Ft	18																												

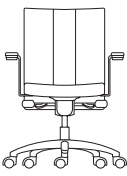
Executive Mid Back Swivel 	AI3622 <ul style="list-style-type: none"> · fixed back · Arctic Silver open arms with textured pad · Arctic Silver powder coated base standard; black nylon base available, no upcharge · seat slider · synchro-tilt mechanism · 21 degrees of tilt travel · 5 position tilt lock with anti-kick-back safety feature · tension control with side activated, telescoping handle · gas assist lift · contrasting textile center, see page 36 for upcharge · seat height range is 18 - 22 ½ 	<table border="1"> <thead> <tr> <th>Dimensions</th> <th>D</th> <th>W</th> <th>H</th> </tr> </thead> <tbody> <tr> <td>Overall</td> <td>26</td> <td>26</td> <td>36 ⅝</td> </tr> <tr> <td>Seat</td> <td>19 ½</td> <td>18 ½</td> <td>22 ½</td> </tr> <tr> <td>Arm</td> <td colspan="3">26</td> </tr> <tr> <th colspan="2">Upholstery</th> <th colspan="2">Shipping</th> </tr> <tr> <td>COM Ydg</td> <td>2</td> <td>Ctn Wt</td> <td>62</td> </tr> <tr> <td>COL Sq Ft</td> <td>36</td> <td>Cu Ft</td> <td>17</td> </tr> </tbody> </table>	Dimensions	D	W	H	Overall	26	26	36 ⅝	Seat	19 ½	18 ½	22 ½	Arm	26			Upholstery		Shipping		COM Ydg	2	Ctn Wt	62	COL Sq Ft	36	Cu Ft	17	COM \$1,314 A \$1,332 B \$1,367 COL/C \$1,427 D \$1,506 E \$1,584 F \$1,667 G \$1,783 H \$1,908 I \$2,105 J \$2,339 L1 \$1,808 L2 \$1,932
		Dimensions	D	W	H																										
Overall	26	26	36 ⅝																												
Seat	19 ½	18 ½	22 ½																												
Arm	26																														
Upholstery		Shipping																													
COM Ydg	2	Ctn Wt	62																												
COL Sq Ft	36	Cu Ft	17																												

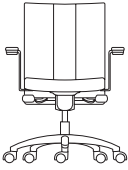
Description	① Model	Specifications			List Price Per Grade	
Executive Mid Back Swivel 	AI3624 • fixed back • Arctic Silver open arms with upholstered pad • Arctic Silver powder coated base standard; black nylon base available, no upcharge • seat slider • synchro-tilt mechanism • 21 degrees of tilt travel • 5 position tilt lock with anti-kick-back safety feature • tension control with side activated, telescoping handle • gas assist lift • contrasting textile center, see page 36 for upcharge • seat height range is 18 - 22 ½	Dimensions	D	W	H	COM \$1,326 A \$1,343 B \$1,378 COL/C \$1,439 D \$1,518 E \$1,595 F \$1,678 G \$1,795 H \$1,920 I \$2,116 J \$2,350 L1 \$1,819 L2 \$1,944
		Overall	26	26	36 5/8	
		Seat	19 ½	18 ½	22 ½	
		Arm			26 1/8	
		Upholstery	Shipping			
		COM Ydg	2	Ctn Wt	58	
		COL Sq Ft	36	Cu Ft	17	

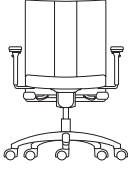
Executive Mid Back Swivel 	AI3626 • fixed back • black adjustable height arms • black nylon base standard; Arctic Silver powder coated base available, specify and add \$84 list • seat slider • synchro-tilt mechanism • 21 degrees of tilt travel • 5 position tilt lock with anti-kick-back safety feature • tension control with side activated, telescoping handle • gas assist lift • contrasting textile center, see page 36 for upcharge • seat height range is 18 - 22 ½ • arm height range is 26 ¼ - 30	Dimensions	D	W	H	COM \$1,248 A \$1,266 B \$1,300 COL/C \$1,361 D \$1,440 E \$1,518 F \$1,601 G \$1,717 H \$1,842 I \$2,039 J \$2,273 L1 \$1,741 L2 \$1,866
		Overall	26	26	36 5/8	
		Seat	19 ½	18 ½	22 ½	
		Arm			30	
		Upholstery	Shipping			
		COM Ydg	2	Ctn Wt	58	
		COL Sq Ft	36	Cu Ft	17	

To Order, Specify:

- ① Model Number
- ② Fabric Selection - vendor, pattern and color
- ③ Contrasting Textile Center - see page 36 for upcharge

② See a selection of graded in fabric manufacturers and patterns on pages 12-20. Contact Customer Service for additional fabric options.

Specifications

- Arctic Silver powder coated or Black nylon 5-Star base with dual wheel casters.
- One piece solid plywood construction.
- Seat interior is high resilient, multi-density polyurethane foam.
- Back interior is multi-density polyurethane foam with foam lumbar support.

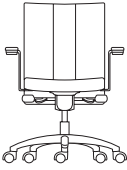
Description	① Model	Specifications				List Price Per Grade	
Executive Mid Back Swivel 	A13623 <ul style="list-style-type: none"> adjustable back Arctic Silver open arms with textured pad Arctic Silver powder coated base standard; black nylon base available, no upcharge seat slider synchro-tilt mechanism 21 degrees of tilt travel 5 position tilt lock with anti-kick-back safety feature tension control with side activated, telescoping handle gas assist lift contrasting textile center, see page 36 for upcharge seat height range is 18 - 22 ½ 	Dimensions		D	W	H	COM \$1,327
		Overall	26	26	36 ⅝		A \$1,344
		Seat	19 ½	18 ½	22 ½		B \$1,379
		Arm			26		COL/C \$1,440
		Upholstery		Shipping			D \$1,519
		COM Ydg	2	Ctn Wt	64		E \$1,596
		COL Sq Ft	36	Cu Ft	17		F \$1,679
							G \$1,796
							H \$1,921
							I \$2,117
							J \$2,351
							L1 \$1,820
							L2 \$1,945

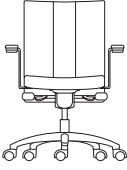
Executive Mid Back Swivel 	A13625 <ul style="list-style-type: none"> adjustable back Arctic Silver open arms with upholstered pad Arctic Silver powder coated base standard; black nylon base available, no upcharge seat slider synchro-tilt mechanism 21 degrees of tilt travel 5 position tilt lock with anti-kick-back safety feature tension control with side activated, telescoping handle gas assist lift contrasting textile center, see page 36 for upcharge seat height range is 18 - 22 ½ 	Dimensions		D	W	H	COM \$1,330
		Overall	26	26	36 ⅝		A \$1,348
		Seat	19 ½	18 ½	22 ½		B \$1,382
		Arm			26 ⅝		COL/C \$1,443
		Upholstery		Shipping			D \$1,522
		COM Ydg	2	Ctn Wt	60		E \$1,600
		COL Sq Ft	36	Cu Ft	17		F \$1,683
							G \$1,799
							H \$1,924
							I \$2,120
							J \$2,355
							L1 \$1,823
							L2 \$1,948

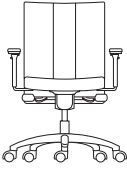
Executive Mid Back Swivel 	A13627 <ul style="list-style-type: none"> adjustable back black adjustable height arms black nylon base standard; Arctic Silver powder coated base available, specify and add \$84 list seat slider synchro-tilt mechanism 21 degrees of tilt travel 5 position tilt lock with anti-kick-back safety feature tension control with side activated, telescoping handle gas assist lift contrasting textile center, see page 36 for upcharge seat height range is 18 - 22 ½ arm height range is 26 ¼ - 30 	Dimensions		D	W	H	COM \$1,281
		Overall	26	26	36 ⅝		A \$1,299
		Seat	19 ½	18 ½	22 ½		B \$1,334
		Arm			30		COL/C \$1,395
		Upholstery		Shipping			D \$1,474
		COM Ydg	2	Ctn Wt	60		E \$1,551
		COL Sq Ft	36	Cu Ft	17		F \$1,634
							G \$1,751
							H \$1,876
							I \$2,072
							J \$2,306
							L1 \$1,775
							L2 \$1,900

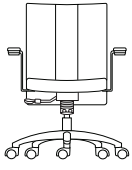
Description	1 Model	Specifications	List Price Per Grade																																										
Management Swivel 	AI3652 <ul style="list-style-type: none"> fixed back Arctic Silver open arms with textured pad Arctic Silver powder coated base standard; black nylon base available, no upcharge mid-pivot swivel tilt seating 20 degrees of tilt travel dual function, combination lever activates gas lift and tilt lock functions contrasting textile center, see page 36 for upcharge seat height range is 18 - 22 1/2 	<table border="1"> <thead> <tr> <th>Dimensions</th> <th>D</th> <th>W</th> <th>H</th> </tr> </thead> <tbody> <tr> <td>Overall</td> <td>26</td> <td>26</td> <td>36 5/8</td> </tr> <tr> <td>Seat</td> <td>19 1/2</td> <td>18 1/2</td> <td>22 1/2</td> </tr> <tr> <td>Arm</td> <td colspan="3">26</td> </tr> </tbody> </table>	Dimensions	D	W	H	Overall	26	26	36 5/8	Seat	19 1/2	18 1/2	22 1/2	Arm	26			<table border="1"> <tbody> <tr> <td>COM</td> <td>\$1,270</td> </tr> <tr> <td>A</td> <td>\$1,288</td> </tr> <tr> <td>B</td> <td>\$1,322</td> </tr> <tr> <td>COL/C</td> <td>\$1,383</td> </tr> <tr> <td>D</td> <td>\$1,462</td> </tr> <tr> <td>E</td> <td>\$1,540</td> </tr> <tr> <td>F</td> <td>\$1,623</td> </tr> <tr> <td>G</td> <td>\$1,739</td> </tr> <tr> <td>H</td> <td>\$1,864</td> </tr> <tr> <td>I</td> <td>\$2,061</td> </tr> <tr> <td>J</td> <td>\$2,295</td> </tr> <tr> <td>L1</td> <td>\$1,763</td> </tr> <tr> <td>L2</td> <td>\$1,888</td> </tr> </tbody> </table>	COM	\$1,270	A	\$1,288	B	\$1,322	COL/C	\$1,383	D	\$1,462	E	\$1,540	F	\$1,623	G	\$1,739	H	\$1,864	I	\$2,061	J	\$2,295	L1	\$1,763	L2	\$1,888
		Dimensions	D	W	H																																								
Overall	26	26	36 5/8																																										
Seat	19 1/2	18 1/2	22 1/2																																										
Arm	26																																												
COM	\$1,270																																												
A	\$1,288																																												
B	\$1,322																																												
COL/C	\$1,383																																												
D	\$1,462																																												
E	\$1,540																																												
F	\$1,623																																												
G	\$1,739																																												
H	\$1,864																																												
I	\$2,061																																												
J	\$2,295																																												
L1	\$1,763																																												
L2	\$1,888																																												
		<table border="1"> <thead> <tr> <th>Upholstery</th> <th colspan="2">Shipping</th> </tr> </thead> <tbody> <tr> <td>COM Ydg</td> <td>2</td> <td>Ctn Wt 58</td> </tr> <tr> <td>COL Sq Ft</td> <td>36</td> <td>Cu Ft 17</td> </tr> </tbody> </table>	Upholstery	Shipping		COM Ydg	2	Ctn Wt 58	COL Sq Ft	36	Cu Ft 17																																		
Upholstery	Shipping																																												
COM Ydg	2	Ctn Wt 58																																											
COL Sq Ft	36	Cu Ft 17																																											

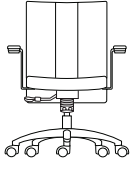
Management Swivel 	AI3654 <ul style="list-style-type: none"> fixed back Arctic Silver open arms with upholstered pad Arctic Silver powder coated base standard; black nylon base available, no upcharge mid-pivot swivel tilt seating 20 degrees of tilt travel dual function, combination lever activates gas lift and tilt lock functions contrasting textile center, see page 36 for upcharge seat height range is 18 - 22 1/2 	<table border="1"> <thead> <tr> <th>Dimensions</th> <th>D</th> <th>W</th> <th>H</th> </tr> </thead> <tbody> <tr> <td>Overall</td> <td>26</td> <td>26</td> <td>36 5/8</td> </tr> <tr> <td>Seat</td> <td>19 1/2</td> <td>18 1/2</td> <td>22 1/2</td> </tr> <tr> <td>Arm</td> <td colspan="3">26 1/8</td> </tr> </tbody> </table>	Dimensions	D	W	H	Overall	26	26	36 5/8	Seat	19 1/2	18 1/2	22 1/2	Arm	26 1/8			<table border="1"> <tbody> <tr> <td>COM</td> <td>\$1,278</td> </tr> <tr> <td>A</td> <td>\$1,296</td> </tr> <tr> <td>B</td> <td>\$1,331</td> </tr> <tr> <td>COL/C</td> <td>\$1,392</td> </tr> <tr> <td>D</td> <td>\$1,470</td> </tr> <tr> <td>E</td> <td>\$1,548</td> </tr> <tr> <td>F</td> <td>\$1,631</td> </tr> <tr> <td>G</td> <td>\$1,748</td> </tr> <tr> <td>H</td> <td>\$1,873</td> </tr> <tr> <td>I</td> <td>\$2,069</td> </tr> <tr> <td>J</td> <td>\$2,303</td> </tr> <tr> <td>L1</td> <td>\$1,772</td> </tr> <tr> <td>L2</td> <td>\$1,897</td> </tr> </tbody> </table>	COM	\$1,278	A	\$1,296	B	\$1,331	COL/C	\$1,392	D	\$1,470	E	\$1,548	F	\$1,631	G	\$1,748	H	\$1,873	I	\$2,069	J	\$2,303	L1	\$1,772	L2	\$1,897
		Dimensions	D	W	H																																								
Overall	26	26	36 5/8																																										
Seat	19 1/2	18 1/2	22 1/2																																										
Arm	26 1/8																																												
COM	\$1,278																																												
A	\$1,296																																												
B	\$1,331																																												
COL/C	\$1,392																																												
D	\$1,470																																												
E	\$1,548																																												
F	\$1,631																																												
G	\$1,748																																												
H	\$1,873																																												
I	\$2,069																																												
J	\$2,303																																												
L1	\$1,772																																												
L2	\$1,897																																												
		<table border="1"> <thead> <tr> <th>Upholstery</th> <th colspan="2">Shipping</th> </tr> </thead> <tbody> <tr> <td>COM Ydg</td> <td>2</td> <td>Ctn Wt 54</td> </tr> <tr> <td>COL Sq Ft</td> <td>36</td> <td>Cu Ft 17</td> </tr> </tbody> </table>	Upholstery	Shipping		COM Ydg	2	Ctn Wt 54	COL Sq Ft	36	Cu Ft 17																																		
Upholstery	Shipping																																												
COM Ydg	2	Ctn Wt 54																																											
COL Sq Ft	36	Cu Ft 17																																											

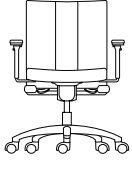
Task Swivel 	AI3696 <ul style="list-style-type: none"> adjustable back Black adjustable height arms Black nylon base standard; Arctic Silver powder coated base available, specify and add \$84 list seat slider synchro-tilt mechanism 21 degrees of tilt travel 5 position tilt lock with anti-kick-back safety feature tension control with side activated, telescoping handle gas assist lift contrasting textile center, see page 36 for upcharge seat height range is 18 - 22 1/2 arm height range is 26 1/4 - 30 	<table border="1"> <thead> <tr> <th>Dimensions</th> <th>D</th> <th>W</th> <th>H</th> </tr> </thead> <tbody> <tr> <td>Overall</td> <td>26</td> <td>26</td> <td>34 5/8</td> </tr> <tr> <td>Seat</td> <td>19 1/2</td> <td>18 1/2</td> <td>22 1/2</td> </tr> <tr> <td>Arm</td> <td colspan="3">30</td> </tr> </tbody> </table>	Dimensions	D	W	H	Overall	26	26	34 5/8	Seat	19 1/2	18 1/2	22 1/2	Arm	30			<table border="1"> <tbody> <tr> <td>COM</td> <td>\$1,226</td> </tr> <tr> <td>A</td> <td>\$1,244</td> </tr> <tr> <td>B</td> <td>\$1,278</td> </tr> <tr> <td>COL/C</td> <td>\$1,339</td> </tr> <tr> <td>D</td> <td>\$1,418</td> </tr> <tr> <td>E</td> <td>\$1,496</td> </tr> <tr> <td>F</td> <td>\$1,579</td> </tr> <tr> <td>G</td> <td>\$1,695</td> </tr> <tr> <td>H</td> <td>\$1,820</td> </tr> <tr> <td>I</td> <td>\$2,016</td> </tr> <tr> <td>J</td> <td>\$2,251</td> </tr> <tr> <td>L1</td> <td>\$1,719</td> </tr> <tr> <td>L2</td> <td>\$1,844</td> </tr> </tbody> </table>	COM	\$1,226	A	\$1,244	B	\$1,278	COL/C	\$1,339	D	\$1,418	E	\$1,496	F	\$1,579	G	\$1,695	H	\$1,820	I	\$2,016	J	\$2,251	L1	\$1,719	L2	\$1,844
		Dimensions	D	W	H																																								
Overall	26	26	34 5/8																																										
Seat	19 1/2	18 1/2	22 1/2																																										
Arm	30																																												
COM	\$1,226																																												
A	\$1,244																																												
B	\$1,278																																												
COL/C	\$1,339																																												
D	\$1,418																																												
E	\$1,496																																												
F	\$1,579																																												
G	\$1,695																																												
H	\$1,820																																												
I	\$2,016																																												
J	\$2,251																																												
L1	\$1,719																																												
L2	\$1,844																																												
		<table border="1"> <thead> <tr> <th>Upholstery</th> <th colspan="2">Shipping</th> </tr> </thead> <tbody> <tr> <td>COM Ydg</td> <td>2</td> <td>Ctn Wt 52</td> </tr> <tr> <td>COL Sq Ft</td> <td>36</td> <td>Cu Ft 16</td> </tr> </tbody> </table>	Upholstery	Shipping		COM Ydg	2	Ctn Wt 52	COL Sq Ft	36	Cu Ft 16																																		
Upholstery	Shipping																																												
COM Ydg	2	Ctn Wt 52																																											
COL Sq Ft	36	Cu Ft 16																																											

To Order, Specify:

- 1 Model Number
- 2 Fabric Selection - vendor, pattern and color
- 3 Contrasting Textile Center - see page 36 for upcharge

- 2 See a selection of graded in fabric manufacturers and patterns on pages 12-20. Contact Customer Service for additional fabric options.

Specifications

- Arctic Silver powder coated or Black nylon 5-Star base with dual wheel casters.
- One piece solid plywood construction.
- Seat interior is high resilient, multi-density polyurethane foam.
- Back interior is multi-density polyurethane foam with foam lumbar support.

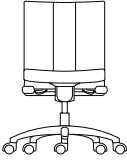
Description	① Model	Specifications				List Price Per Grade	
Task Swivel 	AI3698 · adjustable back · armless · Black nylon base standard; Arctic Silver powder coated base available, specify and add \$84 list · seat slider · synchro-tilt mechanism · 21 degrees of tilt travel · 5 position tilt lock with anti-kick-back safety feature · tension control with side activated, telescoping handle · gas assist lift · contrasting textile center, see below for upcharge · seat height range is 18 - 22 ½	Dimensions		D	W	H	COM \$1,014
		Overall	26	18 ½ [▲]	34 ⅝		A \$1,032
		Seat	19 ½	18 ½	22 ½		B \$1,066
		Upholstery		Shipping			COL/C \$1,127
		COM Ydg	2	Ctn Wt	44		D \$1,206
		COL Sq Ft	36	Cu Ft	16		E \$1,284
							F \$1,367
							G \$1,483
							H \$1,608
							I \$1,804
							J \$2,039
							L1 \$1,507
							L2 \$1,632

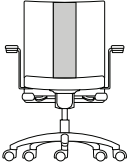
Description	① Model	Specifications		List Price Per Grade	
Optional Contrasting Center 	CONTRASTING TEXTILE CENTER	Upholstery		COM \$108	
		COM Ydg	1		A \$117
		COL Sq Ft	18		B \$137
					COL/C \$172
					D \$215
					E \$259
					F \$327
					G \$401
					H \$479
					I \$601
					J \$748
					L1 \$454
					L2 \$553

To Order, Specify:

- ① Model Number
- ② Fabric Selection - vendor, pattern and color
- ③ Contrasting Textile Center - see above

- ② See a selection of graded in fabric manufacturers and patterns on pages 12-20. Contact Customer Service for additional fabric options.

Specifications

- Arctic Silver powder coated or Black nylon 5-Star base with dual wheel casters.
- One piece solid plywood construction.
- Seat interior is high resilient, multi-density polyurethane foam.
- Back interior is multi-density polyurethane foam with foam lumbar support.

Cabaret Order Check List:



Specify:

- 1. Model Number
- 2. Wood Species - Maple (M)
- 3. Wood Base Finish
- 4. Fabric Selection - vendor, pattern and color
- 5. Base Selection - wood base standard; specify wood finish
 - A. Black Polyurethane Base - no upcharge
 - B. Black Pneumatic Jury Base - add \$164 list
- 6. Optional Plastic Bumper Guard - add \$17 list

Example:

CR1275 (model #)	M (wood species)	AUB (finish) wood base	MOMENTUM (fabric vendor)	VOX (pattern name)	MYSTIC (pattern color)
----------------------------	----------------------------	-------------------------------------	------------------------------------	------------------------------	----------------------------------

1. Model Number

2. Wood Species - Maple (M)

3. Wood Base Finish Options:

ALE Ale	FLX Flax
AUB Auburn	CGR Graphite Coordinate
AUT Autumn	CHL High Line Coordinate
BRL Barley	CKC Khaki Coordinate
CBE Blonde Echo Coordinate	LGC Legacy
BBN Bourbon	MCH Mocha
CBZ Brazilwood Coordinate	NTO Night Owl
BRG Brighton	PRL Praline
BUT Butterscotch	SAF Saffron
CIN Cinnamon	SIE Sienna
CLA Classic	CST Studio Teak Coordinate
CCF Coffee Coordinate	TOF Toffee
CCR Cremello Coordinate	TRF Truffle
EAR Earthy	VEN Venetian
ESP Espresso	CWH Walnut Heights Coordinate

4. Fabric Selection - Please supply the following:

- Fabric vendor
- Pattern name
- Pattern color

When specifying contrasting upholstery, indicate clearly which upholstery is to be applied to the seat, back and arms. Use higher grade pricing.

- Indicate direction of fabric - Railroaded or Up the Roll
- Please provide illustration, if available

All COM orders must include the following:

- Vendor's name, pattern name and color
- Sample of the fabric attached to order
- Model numbers of items for fabric application
- Special application instructions (e.g., all stripes will be applied front to back unless specified otherwise)
- Customer and purchase order number

Ship prepaid COM material to:

JSI
Attn: COM Dept
932 Mill Street
Jasper, IN 47546

Application of fabric:
Railroaded Up the Roll

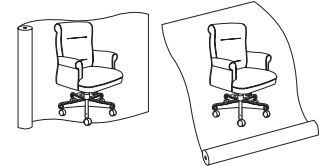

All COM orders will ship at standard lead time from receipt of COM except for orders requiring special custom matched finishes.

5. Base Selection - wood base standard; specify wood finish

- A. Black polyurethane base - no upcharge
- B. Black pneumatic jury base - add \$164 list



Pneumatic lift-
NOT self-centering -
Standard

6. Optional Plastic Bumper Guard - add \$17 list

For Cabaret Guest Seating, see page 80.

Description	① Model	Specifications	List Price Per Grade																												
Executive Swivel 	CR1275 · overall height range is 44 ½ - 48 · seat height range is 20 - 23 · arm height range is 27 ½ - 30 ½	<table border="1"> <thead> <tr> <th>Dimensions</th> <th>D</th> <th>W</th> <th>H</th> </tr> </thead> <tbody> <tr> <td>Overall</td> <td>26</td> <td>28</td> <td>48</td> </tr> <tr> <td>Seat</td> <td>19 ½</td> <td>19</td> <td>23</td> </tr> <tr> <td>Arm</td> <td colspan="3">30 ½</td> </tr> <tr> <th colspan="2">Upholstery</th> <th colspan="2">Shipping</th> </tr> <tr> <td>COM Ydg</td> <td>4</td> <td>Ctn Wt</td> <td>60</td> </tr> <tr> <td>COL Sq Ft</td> <td>72</td> <td>Cu Ft</td> <td>19</td> </tr> </tbody> </table>	Dimensions	D	W	H	Overall	26	28	48	Seat	19 ½	19	23	Arm	30 ½			Upholstery		Shipping		COM Ydg	4	Ctn Wt	60	COL Sq Ft	72	Cu Ft	19	COM \$1,543 A \$1,579 B \$1,648 COL/C \$1,770 D \$1,926 E \$2,083 F \$2,247 G \$2,482 H \$2,732 I \$3,123 J \$3,593 L1 \$2,529 L2 \$2,779
		Dimensions	D	W	H																										
		Overall	26	28	48																										
		Seat	19 ½	19	23																										
		Arm	30 ½																												
		Upholstery		Shipping																											
		COM Ydg	4	Ctn Wt	60																										
		COL Sq Ft	72	Cu Ft	19																										

Management Swivel 	CR1270 · overall height range is 39 ½ - 43 · seat height range is 20 - 23 · arm height range is 27 ½ - 30 ½	<table border="1"> <thead> <tr> <th>Dimensions</th> <th>D</th> <th>W</th> <th>H</th> </tr> </thead> <tbody> <tr> <td>Overall</td> <td>26</td> <td>28</td> <td>43</td> </tr> <tr> <td>Seat</td> <td>19 ½</td> <td>19</td> <td>23</td> </tr> <tr> <td>Arm</td> <td colspan="3">30 ½</td> </tr> <tr> <th colspan="2">Upholstery</th> <th colspan="2">Shipping</th> </tr> <tr> <td>COM Ydg</td> <td>4</td> <td>Ctn Wt</td> <td>55</td> </tr> <tr> <td>COL Sq Ft</td> <td>72</td> <td>Cu Ft</td> <td>19</td> </tr> </tbody> </table>	Dimensions	D	W	H	Overall	26	28	43	Seat	19 ½	19	23	Arm	30 ½			Upholstery		Shipping		COM Ydg	4	Ctn Wt	55	COL Sq Ft	72	Cu Ft	19	COM \$1,487 A \$1,523 B \$1,592 COL/C \$1,714 D \$1,871 E \$2,027 F \$2,192 G \$2,426 H \$2,676 I \$3,068 J \$3,537 L1 \$2,473 L2 \$2,723
		Dimensions	D	W	H																										
		Overall	26	28	43																										
		Seat	19 ½	19	23																										
		Arm	30 ½																												
		Upholstery		Shipping																											
		COM Ydg	4	Ctn Wt	55																										
		COL Sq Ft	72	Cu Ft	19																										

To Order, Specify:

- ① Model Number
- ② Wood Species - Maple (M)
- ③ Wood Base Finish
- ④ Fabric Selection - vendor, pattern and color
- ⑤ Base Selection - wood base standard; specify wood finish
 - A. Black Polyurethane Base - no upcharge
 - B. Black Pneumatic Jury Base - add \$164 list
- ⑥ Optional Plastic Bumper Guard - add \$17 list

③ Wood Base Finish Options:

ALE Ale	FLX Flax
AUB Auburn	CGR Graphite Coordinate
AUT Autumn	CHL High Line Coordinate
BRL Barley	CKC Khaki Coordinate
CBE Blonde Echo Coordinate	LGC Legacy
BBN Bourbon	MCH Mocha
CBZ Brazilwood Coordinate	NTO Night Owl
BRG Brighton	PRL Praline
BUT Butterscotch	SAF Saffron
CIN Cinnamon	SIE Sienna
CLA Classic	CST Studio Teak Coordinate
CCF Coffee Coordinate	TOF Toffee
CCR Cremello Coordinate	TRF Truffle
EAR Earthy	VEN Venetian
ESP Espresso	CWH Walnut Heights Coordinate

Specifications

- Wood species - Maple.
- Seat has synthetic sheet webbing and 4" polyurethane foam.
- Back has polypropylene webbing and 2" polyurethane foam and integrated lumbar support.
- Arms have ½" polyurethane foam.
- Swivel models revolve, adjusts for height and tension, have knee-tilt with a non-tilt locking mechanism and wood base with antique brass dual wheel casters.
- Spiral grooved hardwood dowels with corner blocks, glue and screws.

When ordering Quickship products, place a "Q" in front of model number.
 Example: QGT4901D



- ④ See a selection of graded in fabric manufacturers and patterns on pages 12-20. Contact Customer Service for additional fabric options.

Harbor Order Check List:



Specify:

- 1. Model Number
- 2. Wood Species - Maple (M)
- 3. Wood Base/Arm Detail Finish
- 4. Fabric Selection - vendor, pattern and color
- 5. Base Selection - wood base standard; specify wood finish
 - A. Black Polyurethane Base - no upcharge
 - B. Black Jury Base - add \$164 list
- 6. Optional Plastic Bumper Guard - add \$17 list

Example:

HB2905 (model #)	M (wood species)	AUB (finish) wood base/arm detail	MOMENTUM (fabric vendor)	VOX (pattern name)	MYSTIC (pattern color)
----------------------------	----------------------------	--	------------------------------------	------------------------------	----------------------------------

1. Model Number

2. Wood Species - Maple (M)

3. Wood Base/Arm Detail Finish Options:

ALE Ale	FLX Flax
AUB Auburn	CGR Graphite Coordinate
AUT Autumn	CHL High Line Coordinate
BRL Barley	CKC Khaki Coordinate
CBE Blonde Echo Coordinate	LGC Legacy
BBN Bourbon	MCH Mocha
CBZ Brazilwood Coordinate	NTO Night Owl
BRG Brighton	PRL Praline
BUT Butterscotch	SAF Saffron
CIN Cinnamon	SIE Sienna
CLA Classic	CST Studio Teak Coordinate
CCF Coffee Coordinate	TOF Toffee
CCR Cremello Coordinate	TRF Truffle
EAR Earthy	VEN Venetian
ESP Espresso	CWH Walnut Heights Coordinate

4. Fabric Selection - Please supply the following:

- Fabric vendor
- Pattern name
- Pattern color

When specifying contrasting upholstery, indicate clearly which upholstery is to be applied to the seat, back and arms. Use higher grade pricing.

- Indicate direction of fabric - Railroaded or Up the Roll
- Please provide illustration, if available

All COM orders must include the following:

- Vendor's name, pattern name and color
- Sample of the fabric attached to order
- Model numbers of items for fabric application

- Special application instructions (e.g., all stripes will be applied front to back unless specified otherwise)
- Customer and purchase order number

Ship prepaid COM material to:
JSI
 Attn: COM Dept
 932 Mill Street
 Jasper, IN 47546

Application of fabric:
 Railroaded Up the Roll

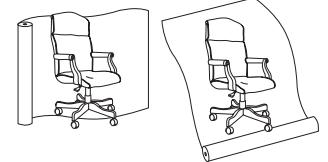

All COM orders will ship at standard lead time from receipt of COM except for orders requiring special custom matched finishes.

5. Base Selection - wood base standard; specify wood finish

- A. Black polyurethane base - no upcharge
- B. Black jury base - add \$164 list



Pneumatic lift - NOT self-centering - Standard





Mechanical self-centering lift - MUST BE SPECIFIED

6. Optional Plastic Bumper Guard - add \$17 list

For Harbor Guest Seating, see page 96.

For Harbor Lounge Seating, see page 312.

SWIVEL

Description	1 Model	Specifications	List Price Per Grade																																										
Executive Swivel 	HB2905 · upholstered open arms · overall height range is 45 ½ - 50 ½ · seat height range is 19 - 24 · arm height range is 27 ½ - 32 ½	<table border="1"> <thead> <tr> <th>Dimensions</th> <th>D</th> <th>W</th> <th>H</th> </tr> </thead> <tbody> <tr> <td>Overall</td> <td>29</td> <td>26 ½</td> <td>50 ½</td> </tr> <tr> <td>Seat</td> <td>19 ½</td> <td>20 ¾</td> <td>24</td> </tr> <tr> <td>Arm</td> <td></td> <td></td> <td>32 ½</td> </tr> </tbody> </table>	Dimensions	D	W	H	Overall	29	26 ½	50 ½	Seat	19 ½	20 ¾	24	Arm			32 ½	<table border="1"> <tbody> <tr> <td>COM</td> <td>\$1,401</td> </tr> <tr> <td>A</td> <td>\$1,425</td> </tr> <tr> <td>B</td> <td>\$1,474</td> </tr> <tr> <td>COL/C</td> <td>\$1,558</td> </tr> <tr> <td>D</td> <td>\$1,665</td> </tr> <tr> <td>E</td> <td>\$1,772</td> </tr> <tr> <td>F</td> <td>\$1,885</td> </tr> <tr> <td>G</td> <td>\$2,047</td> </tr> <tr> <td>H</td> <td>\$2,219</td> </tr> <tr> <td>I</td> <td>\$2,488</td> </tr> <tr> <td>J</td> <td>\$2,810</td> </tr> <tr> <td>L1</td> <td>\$2,079</td> </tr> <tr> <td>L2</td> <td>\$2,251</td> </tr> </tbody> </table>	COM	\$1,401	A	\$1,425	B	\$1,474	COL/C	\$1,558	D	\$1,665	E	\$1,772	F	\$1,885	G	\$2,047	H	\$2,219	I	\$2,488	J	\$2,810	L1	\$2,079	L2	\$2,251
		Dimensions	D	W	H																																								
Overall	29	26 ½	50 ½																																										
Seat	19 ½	20 ¾	24																																										
Arm			32 ½																																										
COM	\$1,401																																												
A	\$1,425																																												
B	\$1,474																																												
COL/C	\$1,558																																												
D	\$1,665																																												
E	\$1,772																																												
F	\$1,885																																												
G	\$2,047																																												
H	\$2,219																																												
I	\$2,488																																												
J	\$2,810																																												
L1	\$2,079																																												
L2	\$2,251																																												
<table border="1"> <thead> <tr> <th>Upholstery</th> <th colspan="2">Shipping</th> </tr> </thead> <tbody> <tr> <td>COM Ydg</td> <td>2 ¾</td> <td>Ctn Wt 50</td> </tr> <tr> <td>COL Sq Ft</td> <td>50</td> <td>Cu Ft 19</td> </tr> </tbody> </table>	Upholstery	Shipping		COM Ydg	2 ¾	Ctn Wt 50	COL Sq Ft	50	Cu Ft 19																																				
Upholstery	Shipping																																												
COM Ydg	2 ¾	Ctn Wt 50																																											
COL Sq Ft	50	Cu Ft 19																																											
Management Swivel 	HB2900 · upholstered open arms · overall height range is 39 - 44 · seat height range is 19 - 24 · arm height range is 27 ½ - 32 ½	<table border="1"> <thead> <tr> <th>Dimensions</th> <th>D</th> <th>W</th> <th>H</th> </tr> </thead> <tbody> <tr> <td>Overall</td> <td>28 ½</td> <td>26 ½</td> <td>44</td> </tr> <tr> <td>Seat</td> <td>19 ½</td> <td>20 ¾</td> <td>24</td> </tr> <tr> <td>Arm</td> <td></td> <td></td> <td>32 ½</td> </tr> </tbody> </table>	Dimensions	D	W	H	Overall	28 ½	26 ½	44	Seat	19 ½	20 ¾	24	Arm			32 ½	<table border="1"> <tbody> <tr> <td>COM</td> <td>\$1,329</td> </tr> <tr> <td>A</td> <td>\$1,351</td> </tr> <tr> <td>B</td> <td>\$1,395</td> </tr> <tr> <td>COL/C</td> <td>\$1,470</td> </tr> <tr> <td>D</td> <td>\$1,568</td> </tr> <tr> <td>E</td> <td>\$1,666</td> </tr> <tr> <td>F</td> <td>\$1,769</td> </tr> <tr> <td>G</td> <td>\$1,916</td> </tr> <tr> <td>H</td> <td>\$2,072</td> </tr> <tr> <td>I</td> <td>\$2,317</td> </tr> <tr> <td>J</td> <td>\$2,610</td> </tr> <tr> <td>L1</td> <td>\$1,945</td> </tr> <tr> <td>L2</td> <td>\$2,102</td> </tr> </tbody> </table>	COM	\$1,329	A	\$1,351	B	\$1,395	COL/C	\$1,470	D	\$1,568	E	\$1,666	F	\$1,769	G	\$1,916	H	\$2,072	I	\$2,317	J	\$2,610	L1	\$1,945	L2	\$2,102
		Dimensions	D	W	H																																								
Overall	28 ½	26 ½	44																																										
Seat	19 ½	20 ¾	24																																										
Arm			32 ½																																										
COM	\$1,329																																												
A	\$1,351																																												
B	\$1,395																																												
COL/C	\$1,470																																												
D	\$1,568																																												
E	\$1,666																																												
F	\$1,769																																												
G	\$1,916																																												
H	\$2,072																																												
I	\$2,317																																												
J	\$2,610																																												
L1	\$1,945																																												
L2	\$2,102																																												
<table border="1"> <thead> <tr> <th>Upholstery</th> <th colspan="2">Shipping</th> </tr> </thead> <tbody> <tr> <td>COM Ydg</td> <td>2 ½</td> <td>Ctn Wt 46</td> </tr> <tr> <td>COL Sq Ft</td> <td>45</td> <td>Cu Ft 14</td> </tr> </tbody> </table>	Upholstery	Shipping		COM Ydg	2 ½	Ctn Wt 46	COL Sq Ft	45	Cu Ft 14																																				
Upholstery	Shipping																																												
COM Ydg	2 ½	Ctn Wt 46																																											
COL Sq Ft	45	Cu Ft 14																																											

To Order, Specify:

- 1 Model Number
- 2 Wood Species - Maple (M)
- 3 Wood Base/Arm Detail Finish
- 4 Fabric Selection - vendor, pattern and color
- 5 Base Selection - wood base standard; specify wood finish
 - A. Black Polyurethane Base - no upcharge
 - B. Black Jury Base - add \$164 list (self-centering manual available - specify when ordering)
- 6 Optional Plastic Bumper Guard - add \$17 list

3 Wood Base/Arm Detail Finish Options:

- | | |
|----------------------------|-------------------------------|
| ALE Ale | FLX Flax |
| AUB Auburn | CGR Graphite Coordinate |
| AUT Autumn | CHL High Line Coordinate |
| BRL Barley | CKC Khaki Coordinate |
| CBE Blonde Echo Coordinate | LGC Legacy |
| BBN Bourbon | MCH Mocha |
| CBZ Brazilwood Coordinate | NTO Night Owl |
| BRG Brighton | PRL Praline |
| BUT Butterscotch | SAF Saffron |
| CIN Cinnamon | SIE Sienna |
| CLA Classic | CST Studio Teak Coordinate |
| CCF Coffee Coordinate | TOF Toffee |
| CCR Cremello Coordinate | TRF Truffle |
| EAR Earthy | VEN Venetian |
| ESP Espresso | CWH Walnut Heights Coordinate |

- 4 See a selection of graded in fabric manufacturers and patterns on pages 12-20. Contact Customer Service for additional fabric options.

Specifications

- Wood species - Maple.
- Seat and back are 3" high density polyurethane foam.
- Swivel models revolve, adjusts for height and tension, have swivel tilt, a pneumatic lift with wood base and black dual wheel casters.
- Arms have ½" polyurethane foam.
- Frame construction consist of one piece molded plywood shell.

Madison Order Check List:



SWIVEL

Specify:

- 1. Model Number
- 2. Wood Species - Maple (M)
- 3. Wood Base/Arm Detail Finish
- 4. Fabric Selection - vendor, pattern and color
- 5. Optional Black Jury Base - add \$164 list; wood base standard
- 6. Optional Knee-Tilt - add \$100 list
- 7. Optional Black Antique Trim Nails - no upcharge
(Replaces standard antique brass trim nails)
- 6. Optional Plastic Bumper Guard - add \$17 list

Example:

MA1500F (model #)	M (wood species)	AUB (finish) wood base/arm detail	MOMENTUM (fabric vendor)	VOX (pattern name)	MYSTIC (pattern color)
-----------------------------	----------------------------	--	------------------------------------	------------------------------	----------------------------------

1. Model Number

2. Wood Species - Maple (M)

3. Wood Base/Arm Detail Finish Options:

ALE Ale	FLX Flax
AUB Auburn	CGR Graphite Coordinate
AUT Autumn	CHL High Line Coordinate
BRL Barley	CKC Khaki Coordinate
CBE Blonde Echo Coordinate	LGC Legacy
BBN Bourbon	MCH Mocha
CBZ Brazilwood Coordinate	NTO Night Owl
BRG Brighton	PRL Praline
BUT Butterscotch	SAF Saffron
CIN Cinnamon	SIE Sienna
CLA Classic	CST Studio Teak Coordinate
CCF Coffee Coordinate	TOF Toffee
CCR Cremello Coordinate	TRF Truffle
EAR Earthy	VEN Venetian
ESP Espresso	CWH Walnut Heights Coordinate

4. Fabric Selection - Please supply the following:

- Fabric vendor
- Pattern name
- Pattern color

When specifying contrasting upholstery, indicate clearly which upholstery is to be applied to the seat, back and arms. Use higher grade pricing.

- Indicate direction of fabric - Railroaded or Up the Roll
- Please provide illustration, if available

All COM orders must include the following:

- Vendor's name, pattern name and color
- Sample of the fabric attached to order
- Model numbers of items for fabric application
- Special application instructions (e.g., all stripes will be applied front to back unless specified otherwise)
- Customer and purchase order number

Ship prepaid COM material to:
 JSI
 Attn: COM Dept
 932 Mill Street
 Jasper, IN 47546

Application of fabric:
 Railroaded Up the Roll

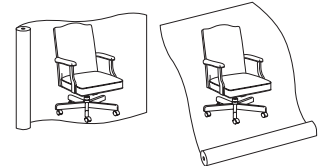

All COM orders will ship at standard lead time from receipt of COM except for orders requiring special custom matched finishes.

5. Optional Black Jury Base - add \$164 list

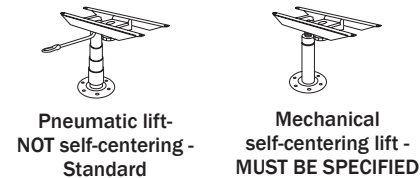

6. Optional Knee-Tilt - add \$100 list

7. Optional Black Antique Trim Nails - no upcharge
(Replaces standard antique brass trim nails)

8. Optional Plastic Bumper Guard - add \$17 list

For Madison Guest Seating, see page 107.



SWIVEL

Description	① Model	Specifications				List Price Per Grade		
Executive Swivel 	MA1500F · plain seat and back · upholstered arm cap · overall height range is 40½ - 44 · seat height range is 19 - 22½ · arm height range is 25½ - 29	Dimensions		D	W	H	COM \$1,123	
		Overall		25	26½	44	A \$1,145	
		Seat		18½	21½	22½	B \$1,189	
		Arm		29			COL/C \$1,265	
		Upholstery		Shipping				D \$1,362
		COM Ydg		2½	Ctn Wt	58	E \$1,460	
		COL Sq Ft		45	Cu Ft	15	F \$1,563	
							G \$1,710	
							H \$1,866	
							I \$2,111	
					J \$2,404			
					L1 \$1,739			
					L2 \$1,896			

Executive Swivel with Trim Nails 	MA1500J · plain seat and back · upholstered arm cap · Antique Brass trim nails · overall height range is 40½ - 44 · seat height range is 19 - 22½ · arm height range is 25½ - 29	Dimensions		D	W	H	COM \$1,229	
		Overall		25	26½	44	A \$1,251	
		Seat		18½	21½	22½	B \$1,295	
		Arm		29			COL/C \$1,371	
		Upholstery		Shipping				D \$1,468
		COM Ydg		2½	Ctn Wt	58	E \$1,566	
		COL Sq Ft		45	Cu Ft	15	F \$1,669	
							G \$1,816	
							H \$1,972	
							I \$2,217	
					J \$2,510			
					L1 \$1,845			
					L2 \$2,002			

Executive Swivel 	MA1530F · plain seat and back · upholstered arm rest · overall height range is 40½ - 44 · seat height range is 19 - 22½ · arm height range is 25½ - 29	Dimensions		D	W	H	COM \$1,225	
		Overall		25	26½	44	A \$1,247	
		Seat		18½	21½	22½	B \$1,291	
		Arm		29			COL/C \$1,367	
		Upholstery		Shipping				D \$1,464
		COM Ydg		2½	Ctn Wt	58	E \$1,562	
		COL Sq Ft		45	Cu Ft	15	F \$1,665	
							G \$1,812	
							H \$1,968	
							I \$2,213	
					J \$2,506			
					L1 \$1,841			
					L2 \$1,998			

Executive Swivel with Trim Nails 	MA1530J · plain seat and back · Antique Brass trim nails · upholstered arm rest · overall height range is 40½ - 44 · seat height range is 19 - 22½ · arm height range is 25½ - 29	Dimensions		D	W	H	COM \$1,331	
		Overall		25	26½	44	A \$1,353	
		Seat		18½	21½	22½	B \$1,397	
		Arm		29			COL/C \$1,473	
		Upholstery		Shipping				D \$1,570
		COM Ydg		2½	Ctn Wt	58	E \$1,668	
		COL Sq Ft		45	Cu Ft	15	F \$1,771	
							G \$1,918	
							H \$2,074	
							I \$2,319	
					J \$2,612			
					L1 \$1,947			
					L2 \$2,104			

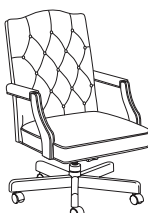
Description	Model	Specifications				List Price Per Grade	
Executive Swivel 	MA1500G • fold tufted back • plain seat • upholstered arm cap • overall height range is 40 ½ - 44 • seat height range is 19 - 22 ½ • arm height range is 25 ½ - 29	Dimensions		D	W	H	COM \$1,239
		Overall	25	26 ½	44	A \$1,266	
		Seat	18 ½	21 ½	22 ½	B \$1,318	
		Arm	29			COL/C \$1,410	
		Upholstery		Shipping		D \$1,527	
		COM Ydg	3	Ctn Wt	58	E \$1,644	
		COL Sq Ft	54	Cu Ft	15	F \$1,768	
						G \$1,944	
						H \$2,131	
						I \$2,425	
						J \$2,777	
						L1 \$1,979	
						L2 \$2,167	
Executive Swivel with Trim Nails 	MA1500K • fold tufted back • plain seat • upholstered arm cap • Antique Brass trim nails • overall height range is 40 ½ - 44 • seat height range is 19 - 22 ½ • arm height range is 25 ½ - 29	Dimensions		D	W	H	COM \$1,329
		Overall	25	26 ½	44	A \$1,355	
		Seat	18 ½	21 ½	22 ½	B \$1,407	
		Arm	29			COL/C \$1,499	
		Upholstery		Shipping		D \$1,616	
		COM Ydg	3	Ctn Wt	58	E \$1,733	
		COL Sq Ft	54	Cu Ft	15	F \$1,857	
						G \$2,033	
						H \$2,220	
						I \$2,514	
						J \$2,866	
						L1 \$2,068	
						L2 \$2,256	
Executive Swivel 	MA1530G • fold tufted back • plain seat • upholstered arm rest • overall height range is 40 ½ - 44 • seat height range is 19 - 22 ½ • arm height range is 25 ½ - 29	Dimensions		D	W	H	COM \$1,341
		Overall	25	26 ½	44	A \$1,368	
		Seat	18 ½	21 ½	22 ½	B \$1,420	
		Arm	29			COL/C \$1,511	
		Upholstery		Shipping		D \$1,629	
		COM Ydg	3	Ctn Wt	58	E \$1,746	
		COL Sq Ft	54	Cu Ft	15	F \$1,869	
						G \$2,046	
						H \$2,233	
						I \$2,527	
						J \$2,879	
						L1 \$2,081	
						L2 \$2,268	

To Order, Specify:

- 1 Model Number
- 2 Wood Species - Maple (M)
- 3 Wood Base/Arm Detail Finish
- 4 Fabric Selection - vendor, pattern and color
- 5 Optional Black Jury Base - add \$164 list; wood base standard (self-centering manual available - specify when ordering)
- 6 Optional Knee-Tilt - add \$100 list
- 7 Optional Black Antique Trim Nails - replaces standard antique brass - no upcharge
- 8 Optional Plastic Bumper Guard - add \$17 list

3 Wood Base/Arm Detail Finish Options:

- | | |
|----------------------------|-------------------------------|
| ALE Ale | FLX Flax |
| AUB Auburn | CGR Graphite Coordinate |
| AUT Autumn | CHL High Line Coordinate |
| BRL Barley | CKC Khaki Coordinate |
| CBE Blonde Echo Coordinate | LGC Legacy |
| BBN Bourbon | MCH Mocha |
| CBZ Brazilwood Coordinate | NTO Night Owl |
| BRG Brighton | PRL Praline |
| BUT Butterscotch | SAF Saffron |
| CIN Cinnamon | SIE Sienna |
| CLA Classic | CST Studio Teak Coordinate |
| CCF Coffee Coordinate | TOF Toffee |
| CCR Cremello Coordinate | TRF Truffle |
| EAR Earthy | VEN Venetian |
| ESP Espresso | CWH Walnut Heights Coordinate |

Specifications

- Wood species - Maple.
- Seat has synthetic sheet webbing and 3" polyurethane foam.
- Back has polypropylene webbing and 2" polyurethane foam.
- Arms have 1 ½" polyurethane foam.
- Swivels revolve, tilt, a wood base with antique brass dual wheel casters and a pneumatic lift.
- Mortise and tenon construction with corner blocks, glue and screws.

- 4 See a selection of graded in fabric manufacturers and patterns on pages 12-20. Contact Customer Service for additional fabric options.

When ordering Quickship products, place a "Q" in front of model number.
 Example: QGT4901D



Description

1 Model

Specifications

List Price Per Grade

Executive Swivel with Trim Nails

MA1530K

- fold tufted back
- plain seat
- upholstered arm rest
- Antique Brass trim nails
- overall height range is 40 1/2 - 44
- seat height range is 19 - 22 1/2
- arm height range is 25 1/2 - 29

Dimensions	D	W	H
Overall	25	26 1/2	44
Seat	18 1/2	21 1/2	22 1/2
Arm			29
Upholstery		Shipping	
COM Ydg	3	Ctn Wt	58
COL Sq Ft	54	Cu Ft	15

- COM \$1,431
- A \$1,457
- B \$1,509
- COL/C \$1,601
- D \$1,718
- E \$1,835
- F \$1,959
- G \$2,135
- H \$2,322
- I \$2,616
- J \$2,968
- L1 \$2,170
- L2 \$2,358

NOW!



SWIVEL

To Order, Specify:

- 1 Model Number
- 2 Wood Species - Maple (M)
- 3 Wood Base/Arm Detail Finish
- 4 Fabric Selection - vendor, pattern and color
- 5 Optional Black Jury Base - add \$164 list; wood base standard (self-centering manual available - specify when ordering)
- 6 Optional Knee-Tilt - add \$100 list
- 7 Optional Black Antique Trim Nails - replaces standard antique brass - no upcharge
- 8 Optional Plastic Bumper Guard - add \$17 list

3 Wood Base/Arm Detail Finish Options:

ALE Ale	FLX Flax
AUB Auburn	CGR Graphite Coordinate
AUT Autumn	CHL High Line Coordinate
BRL Barley	CKC Khaki Coordinate
CBE Blonde Echo Coordinate	LGC Legacy
BBN Bourbon	MCH Mocha
CBZ Brazilwood Coordinate	NTO Night Owl
BRG Brighton	PRL Praline
BUT Butterscotch	SAF Saffron
CIN Cinnamon	SIE Sienna
CLA Classic	CST Studio Teak Coordinate
CCF Coffee Coordinate	TOF Toffee
CCR Cremello Coordinate	TRF Truffle
EAR Earthy	VEN Venetian
ESP Espresso	CWH Walnut Heights Coordinate

Specifications

- Wood species - Maple.
- Seat has synthetic sheet webbing and 3" polyurethane foam.
- Back has polypropylene webbing and 2" polyurethane foam.
- Arms have 1 1/2" polyurethane foam.
- Swivels revolve, tilt, a wood base with antique brass dual wheel casters and a pneumatic lift.
- Mortise and tenon construction with corner blocks, glue and screws.

When ordering Quickship products, place a "Q" in front of model number.
Example: QGT4901D

NOW!
Need it.
JSI Quickship

- 4 See a selection of graded in fabric manufacturers and patterns on pages 12-20. Contact Customer Service for additional fabric options.

Newton Order Check List:



SWIVEL

Specify:

- 1. Model Number
- 2. Fabric Selection - vendor, pattern and color
- 3. Base and Arm Selections - standard with black polyurethane base and arms
 - A. Aluminum Base Only - add \$84 list
 - B. Aluminum Base and arms - add \$223 list
 - C. Optional Base Glides - add \$10 list
 - D. Optional Black Pneumatic Jury Base - add \$164 list
- 4. Optional Mid-Pivot Mechanism - add \$108 list

Example:

NW5100 | MOMENTUM | VOX | MYSTIC
 (model #) | (fabric vendor) | (pattern name) | (pattern color)

1. Model Number

2. Fabric Selection - Please supply the following:

- Fabric vendor
- Pattern name
- Pattern color

When specifying contrasting upholstery, indicate clearly which upholstery is to be applied to the seat, back and arms. Use higher grade pricing.

- Indicate direction of fabric - Railroaded or Up the Roll
- Please provide illustration, if available

All COM orders must include the following:

- Vendor's name, pattern name and color
- Sample of the fabric attached to order
- Model numbers of items for fabric application
- Special application instructions (e.g., all stripes will be applied front to back unless specified otherwise)
- Customer and purchase order number

Ship prepaid COM material to:
 JSI
 Attn: COM Dept
 932 Mill Street
 Jasper, IN 47546

Application of fabric:
 Railroaded Up the Roll

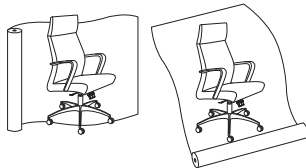

All COM orders will ship at standard lead time from receipt of COM except for orders requiring special custom matched finishes.

3. Base and Arm Selections - standard with black polyurethane base and arms

- A. Aluminum Base Only - add \$84 list
- B. Aluminum Base and arms - add \$223 list
- C. Optional Base Glides - add \$10 list



D. Optional Black Pneumatic Jury Base - add \$164 list



Pneumatic lift - NOT self-centering - Standard

4. Pneumatic Swivel Tilt Control (Standard) -



Optional mid-pivot mechanism with tilt lock - add \$108 list

STANDARD SCALE

SWIVEL

Description	① Model	Specifications				List Price Per Grade
		Dimensions	D	W	H	
Standard Scale Management Mid Back NW5100 · armless · black polyurethane base · overall height range is 36 ½ - 40 ¼ · seat height range is 16 ¾ - 20 ½		Overall	26 ½	26 ½	40 ¼	COM \$847
		Seat	17 ½	20 ¼	20 ½	A \$863 B \$893 COL/C \$947
		Upholstery		Shipping		D \$1,015
		COM Ydg	1 ¾	Ctn Wt	34	E \$1,083
		COL Sq Ft	32	Cu Ft	17	F \$1,155 G \$1,257 H \$1,368 I \$1,539 J \$1,743 L1 \$1,278 L2 \$1,388

Description	① Model	Specifications				List Price Per Grade
		Dimensions	D	W	H	
Standard Scale Management Mid Back NW5110 · black polyurethane arms and base · overall height range is 36 ½ - 40 ¼ · seat height range is 16 ¾ - 20 ½ · arm height range is 25 ¼ - 29		Overall	26 ½	26 ½	40 ¼	COM \$957
		Seat	17 ½	20 ¼	20 ½	A \$973 B \$1,003 COL/C \$1,057
		Arm			29	D \$1,125
		Upholstery		Shipping		E \$1,193
		COM Ydg	1 ¾	Ctn Wt	38	F \$1,266
		COL Sq Ft	32	Cu Ft	17	G \$1,368 H \$1,478 I \$1,649 J \$1,854 L1 \$1,389 L2 \$1,498

Description	① Model	Specifications				List Price Per Grade
		Dimensions	D	W	H	
Standard Scale Executive High Back NW5120 · armless · black polyurethane base · overall height range is 44 ¾ - 48 ½ · seat height range is 16 ¾ - 20 ½		Overall	26 ½	26 ½	48 ½	COM \$1,036
		Seat	17 ½	20 ¼	20 ½	A \$1,054 B \$1,088 COL/C \$1,149
		Upholstery		Shipping		D \$1,228
		COM Ydg	2	Ctn Wt	42	E \$1,306
		COL Sq Ft	36	Cu Ft	19	F \$1,389 G \$1,505 H \$1,630 I \$1,826 J \$2,061 L1 \$1,529 L2 \$1,654

Description	① Model	Specifications				List Price Per Grade
		Dimensions	D	W	H	
Standard Scale Executive High Back NW5121 · black polyurethane arms and base · overall height range is 44 ¾ - 48 ½ · seat height range is 16 ¾ - 20 ½ · arm height range is 25 ¼ - 29		Overall	26 ½	26 ½	48 ½	COM \$1,159
		Seat	17 ½	20 ¼	20 ½	A \$1,176 B \$1,211 COL/C \$1,272
		Arm			29	D \$1,351
		Upholstery		Shipping		E \$1,428
		COM Ydg	2	Ctn Wt	46	F \$1,511
		COL Sq Ft	36	Cu Ft	19	G \$1,628 H \$1,753 I \$1,949 J \$2,183 L1 \$1,652 L2 \$1,777

GRAND SCALE

Description	① Model	Specifications				List Price Per Grade	
Grand Scale Management Mid Back 	NW5130 • armless • black polyurethane base • overall height range is 37 1/2 - 41 1/4 • seat height range is 16 3/4 - 20 1/2	Dimensions		D	W	H	COM \$881 A \$897 B \$928 COL/C \$981 D \$1,049 E \$1,118 F \$1,190 G \$1,292 H \$1,402 I \$1,573 J \$1,778 L1 \$1,313 L2 \$1,422
		Overall		26 1/2	26 1/2	41 1/4	
		Seat		19 1/4	21 1/4	20 1/2	
		Upholstery		Shipping			
		COM Ydg	1 3/4	Ctn Wt	36		
COL Sq Ft	32	Cu Ft	17				
Grand Scale Management Mid Back 	NW5140 • black polyurethane arms and base • overall height range is 37 1/2 - 41 1/4 • seat height range is 16 3/4 - 20 1/2 • arm height range is 25 1/4 - 29	Dimensions		D	W	H	COM \$994 A \$1,010 B \$1,040 COL/C \$1,094 D \$1,162 E \$1,230 F \$1,302 G \$1,404 H \$1,515 I \$1,686 J \$1,890 L1 \$1,425 L2 \$1,535
		Overall		26 1/2	26 1/2	41 1/4	
		Seat		19 1/4	21 1/4	20 1/2	
		Arm				29	
		Upholstery		Shipping			
COM Ydg	1 3/4	Ctn Wt	40				
COL Sq Ft	32	Cu Ft	17				
Grand Scale Executive High Back 	NW5151 • black polyurethane arms and base • overall height range is 45 3/4 - 49 1/2 • seat height range is 16 3/4 - 20 1/2 • arm height range is 25 1/4 - 29	Dimensions		D	W	H	COM \$1,191 A \$1,211 B \$1,250 COL/C \$1,319 D \$1,406 E \$1,495 F \$1,588 G \$1,719 H \$1,860 I \$2,081 J \$2,344 L1 \$1,746 L2 \$1,886
		Overall		26 1/2	26 1/2	49 1/2	
		Seat		19 1/4	21 1/4	20 1/2	
		Arm				29	
		Upholstery		Shipping			
COM Ydg	2 1/4	Ctn Wt	48				
COL Sq Ft	41	Cu Ft	19				

SWIVEL

To Order, Specify:

- ① Model Number
- ② Fabric Selection - vendor, pattern and color
- ③ Base and Arm Selections - standard with black polyurethane base and arms
 - A. Aluminum Base Only - add \$84 list
 - B. Aluminum Base and Arms - add \$223 list
 - C. Base Glides - add \$10 list
 - D. Black Pneumatic Jury Base - add \$164 list
- ④ Optional Mid-Pivot Mechanism (MP) - add \$108 list

- ② See a selection of graded in fabric manufacturers and patterns on pages 12-20. Contact Customer Service for additional fabric options.

Specifications

- Wood species - Solid Birch plywood.
- Mortise and tenon construction with corner blocks, glue and screws.
- Seat has 3 1/2" polyurethane foam with Dacron® wrap.
- Back has synthetic sheet webbing and 1" polyurethane foam.
- All models standard with swivel, tilt, pneumatic lift, tension adjustment and dual wheel casters.

When ordering Quickship products, place a "Q" in front of model number.
 Example: QGT4901D

NOW!
Need it.
 JSI Quickship

Portrait Order Check List:



SWIVEL

Specify:

- 1. Model Number
- 2. Wood Species - Maple (M)
- 3. Wood Finish
- 4. Fabric Selection - vendor, pattern and color
- 5. Button/Reverse Diamond Detail - add \$139 list
- 6. Optional Conference Self-Return Swivel Mechanism - add \$112 list

Example:

P09012 | **M** | **AUB** | **MOMENTUM** | **VOX** | **MYSTIC**
 (model #) | (wood species) | (finish) | (fabric vendor) | (pattern name) | (pattern color)

1. Model Number

2. Wood Species - Maple (M)

3. Wood Finish Options:

ALE Ale	FLX Flax
AUB Auburn	CGR Graphite Coordinate
AUT Autumn	CHL High Line Coordinate
BRL Barley	CKC Khaki Coordinate
CBE Blonde Echo Coordinate	LGC Legacy
BBN Bourbon	MCH Mocha
CBZ Brazilwood Coordinate	NTO Night Owl
BRG Brighton	PRL Praline
BUT Butterscotch	SAF Saffron
CIN Cinnamon	SIE Sienna
CLA Classic	CST Studio Teak Coordinate
CCF Coffee Coordinate	TOF Toffee
CCR Cremello Coordinate	TRF Truffle
EAR Earthy	VEN Venetian
ESP Espresso	CWH Walnut Heights Coordinate

4. Fabric Selection - Please supply the following:

- Vendor name
- Pattern name
- Pattern color

When specifying contrasting upholstery, indicate clearly which upholstery is to be applied to the seat and back. Use higher grade pricing.

- Indicate direction of fabric - Railroaded or Up the Roll
- Please provide illustration, if available

All COM orders must include the following:

- Vendor's name, pattern name and color
- Sample of the fabric attached to order
- Model numbers of items for fabric application
- Special application instructions (e.g., all stripes will be applied front to back unless specified otherwise)
- Customer and purchase order number

Ship prepaid COM material to:
 JSI
 Attn: COM Dept
 932 Mill Street
 Jasper, IN 47546

Application of fabric:
 Railroaded Up the Roll

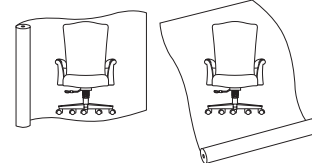

All COM orders will ship at standard lead time from receipt of COM except for orders requiring special custom matched finishes.

5. Button/Reverse Diamond Detail - add \$139 list.



Fabric direction on top and bottom sections run with the nap. Side sections run railroad. EX: stripes run vertical on top and bottom sections and horizontal on side sections.

6. Optional Conference Self-Return Mechanism - add \$112 list. Conference self-return mechanisms have a fixed seat height

For Portrait Guest Seating, see page 113.

For Portrait Lounge Seating, see page 390.

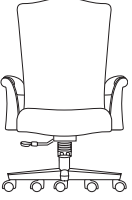
Description	Model	Specifications			List Price Per Grade		
		Dimensions	D	W	H	COM	
Executive High Back 	P09012 <ul style="list-style-type: none"> · scroll arm · open wood arm with upholstered arm rest · arm is carved and shaped maple with foam wrap upholstered arm rest · seat height range is 17 ½ - 20 ¾ ▲ · arm height range is 25 ¼ - 28 ½ ▲ · back height range is 40 - 43 ¼ ▲ 	Overall	28 ½	28 ¾	43 ¼ ▲	COM	\$2,170
		Seat	17 ½	20 ¾	20 ¾	A	\$2,196
		Arm			24 ½	B	\$2,249
		Upholstery		Shipping		COL/C	\$2,340
		COM Ydg	3	Ctn Wt	67	D	\$2,457
		COL Sq Ft	54	Cu Ft	23	E	\$2,574
						F	\$2,698
						G	\$2,874
						H	\$3,061
						I	\$3,355
						J	\$3,707
						L1	\$2,909
						L2	\$3,097

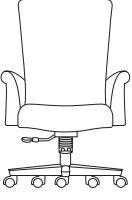
Description	Model	Specifications			List Price Per Grade		
		Dimensions	D	W	H	COM	
Executive High Back 	P09013 <ul style="list-style-type: none"> · scroll arm, fully upholstered · arm interior is framed hardwood with foam wrap · seat height range is 17 ½ - 20 ¾ ▲ · arm height range is 25 ¼ - 28 ½ ▲ · back height range is 40 - 43 ¼ ▲ 	Overall	28 ½	28 ¾	43 ¼ ▲	COM	\$2,163
		Seat	17 ½	20 ¼	20 ¾	A	\$2,197
		Arm			24 ½	B	\$2,262
		Upholstery		Shipping		COL/C	\$2,376
		COM Ydg	3 ¾	Ctn Wt	67	D	\$2,523
		COL Sq Ft	68	Cu Ft	23	E	\$2,670
						F	\$2,824
						G	\$3,043
						H	\$3,279
						I	\$3,645
						J	\$4,085
						L1	\$3,087
						L2	\$3,322

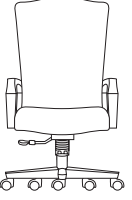
Description	Model	Specifications			List Price Per Grade		
		Dimensions	D	W	H	COM	
Executive High Back 	P09016 <ul style="list-style-type: none"> · regency arm, open wood arm · arm exterior is carved and shaped maple · seat height range is 17 ½ - 20 ¾ ▲ · arm height range is 25 ¼ - 28 ½ ▲ · back height range is 40 - 43 ¼ ▲ 	Overall	28 ½	25 ¼	43 ¼ ▲	COM	\$1,986
		Seat	17 ½	20 ½	20 ¾	A	\$2,012
		Arm			24 ½	B	\$2,065
		Upholstery		Shipping		COL/C	\$2,156
		COM Ydg	3	Ctn Wt	67	D	\$2,274
		COL Sq Ft	54	Cu Ft	21	E	\$2,390
						F	\$2,514
						G	\$2,691
						H	\$2,877
						I	\$3,171
						J	\$3,523
						L1	\$2,725
						L2	\$2,913

To Order, Specify:

- 1 Model Number
- 2 Wood Species - Maple (M)
- 3 Wood Finish
- 4 Fabric Selection - vendor, pattern and color
- 5 Button/Reverse Diamond Detail - add \$139 list
- 6 Optional Conference Self - Return Swivel Mechanism - add \$112 list

3 Wood Finish Options:



- | | |
|----------------------------|-------------------------------|
| ALE Ale | FLX Flax |
| AUB Auburn | CGR Graphite Coordinate |
| AUT Autumn | CHL High Line Coordinate |
| BRL Barley | CKC Khaki Coordinate |
| CBE Blonde Echo Coordinate | LGC Legacy |
| BBN Bourbon | MCH Mocha |
| CBZ Brazilwood Coordinate | NTO Night Owl |
| BRG Brighton | PRL Praline |
| BUT Butterscotch | SAF Saffron |
| CIN Cinnamon | SIE Sienna |
| CLA Classic | CST Studio Teak Coordinate |
| CCF Coffee Coordinate | TOF Toffee |
| CCR Cremello Coordinate | TRF Truffle |
| EAR Earthy | VEN Venetian |
| ESP Espresso | CWH Walnut Heights Coordinate |

- 4 See a selection of graded in fabric manufacturers and patterns on pages 12-20. Contact Customer Service for additional fabric options.

Specifications

- Wood species - Maple.
- Seat has synthetic sheet webbing with high resiliency seat polyurethane foam and Dacron® wrap.
- Frame interior is hardwood joined with double dowels.
- Back has polypropylene webbing and polyurethane foam with Dacron® wrap.
- All backs have button/reverse diamond detail option.
- Adjustment is mid-pivot, mid-knee tilt with gas height adjustment.
- C706, wood base cap.
- C10, hooded black double wheel caster.
- Caster is hard tread.

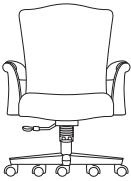
SWIVEL

Description	① Model	Specifications	List Price Per Grade																												
Management Mid Back 	P09022 · scroll arm · open wood arm with upholstered arm rest · arm is carved and shaped maple with foam wrap upholstered arm rest · seat height range is 17 ½ - 20 ¾ · arm height range is 21 - 24 ¼	<table border="1"> <thead> <tr> <th>Dimensions</th> <th>D</th> <th>W</th> <th>H</th> </tr> </thead> <tbody> <tr> <td>Overall</td> <td>28 ½</td> <td>28 ¾</td> <td>40 ¼</td> </tr> <tr> <td>Seat</td> <td>17 ½</td> <td>20 ¾</td> <td>20 ¾</td> </tr> <tr> <td>Arm</td> <td></td> <td></td> <td>24 ¼</td> </tr> </tbody> </table>	Dimensions	D	W	H	Overall	28 ½	28 ¾	40 ¼	Seat	17 ½	20 ¾	20 ¾	Arm			24 ¼	<table border="1"> <thead> <tr> <th colspan="2">Upholstery</th> <th colspan="2">Shipping</th> </tr> </thead> <tbody> <tr> <td>COM Ydg</td> <td>2 ¾</td> <td>Ctn Wt</td> <td>59</td> </tr> <tr> <td>COL Sq Ft</td> <td>50</td> <td>Cu Ft</td> <td>21</td> </tr> </tbody> </table>	Upholstery		Shipping		COM Ydg	2 ¾	Ctn Wt	59	COL Sq Ft	50	Cu Ft	21
		Dimensions	D	W	H																										
Overall	28 ½	28 ¾	40 ¼																												
Seat	17 ½	20 ¾	20 ¾																												
Arm			24 ¼																												
Upholstery		Shipping																													
COM Ydg	2 ¾	Ctn Wt	59																												
COL Sq Ft	50	Cu Ft	21																												
			<table border="1"> <tbody> <tr><td>COM</td><td>\$2,092</td></tr> <tr><td>A</td><td>\$2,116</td></tr> <tr><td>B</td><td>\$2,165</td></tr> <tr><td>COL/C</td><td>\$2,249</td></tr> <tr><td>D</td><td>\$2,356</td></tr> <tr><td>E</td><td>\$2,463</td></tr> <tr><td>F</td><td>\$2,576</td></tr> <tr><td>G</td><td>\$2,738</td></tr> <tr><td>H</td><td>\$2,910</td></tr> <tr><td>I</td><td>\$3,179</td></tr> <tr><td>J</td><td>\$3,501</td></tr> <tr><td>L1</td><td>\$2,770</td></tr> <tr><td>L2</td><td>\$2,942</td></tr> </tbody> </table>	COM	\$2,092	A	\$2,116	B	\$2,165	COL/C	\$2,249	D	\$2,356	E	\$2,463	F	\$2,576	G	\$2,738	H	\$2,910	I	\$3,179	J	\$3,501	L1	\$2,770	L2	\$2,942		
COM	\$2,092																														
A	\$2,116																														
B	\$2,165																														
COL/C	\$2,249																														
D	\$2,356																														
E	\$2,463																														
F	\$2,576																														
G	\$2,738																														
H	\$2,910																														
I	\$3,179																														
J	\$3,501																														
L1	\$2,770																														
L2	\$2,942																														
Management Mid Back 	P09023 · scroll arm, fully upholstered · arm interior is framed hardwood with foam wrap · seat height range is 17 ½ - 20 ¾ · arm height range is 21 - 24 ¼	<table border="1"> <thead> <tr> <th>Dimensions</th> <th>D</th> <th>W</th> <th>H</th> </tr> </thead> <tbody> <tr> <td>Overall</td> <td>28 ½</td> <td>28 ¾</td> <td>40 ¼</td> </tr> <tr> <td>Seat</td> <td>17 ½</td> <td>20 ¼</td> <td>20 ¾</td> </tr> <tr> <td>Arm</td> <td></td> <td></td> <td>24 ¼</td> </tr> </tbody> </table>	Dimensions	D	W	H	Overall	28 ½	28 ¾	40 ¼	Seat	17 ½	20 ¼	20 ¾	Arm			24 ¼	<table border="1"> <thead> <tr> <th colspan="2">Upholstery</th> <th colspan="2">Shipping</th> </tr> </thead> <tbody> <tr> <td>COM Ydg</td> <td>3</td> <td>Ctn Wt</td> <td>59</td> </tr> <tr> <td>COL Sq Ft</td> <td>54</td> <td>Cu Ft</td> <td>21</td> </tr> </tbody> </table>	Upholstery		Shipping		COM Ydg	3	Ctn Wt	59	COL Sq Ft	54	Cu Ft	21
		Dimensions	D	W	H																										
Overall	28 ½	28 ¾	40 ¼																												
Seat	17 ½	20 ¼	20 ¾																												
Arm			24 ¼																												
Upholstery		Shipping																													
COM Ydg	3	Ctn Wt	59																												
COL Sq Ft	54	Cu Ft	21																												
			<table border="1"> <tbody> <tr><td>COM</td><td>\$2,073</td></tr> <tr><td>A</td><td>\$2,099</td></tr> <tr><td>B</td><td>\$2,152</td></tr> <tr><td>COL/C</td><td>\$2,243</td></tr> <tr><td>D</td><td>\$2,361</td></tr> <tr><td>E</td><td>\$2,477</td></tr> <tr><td>F</td><td>\$2,601</td></tr> <tr><td>G</td><td>\$2,778</td></tr> <tr><td>H</td><td>\$2,965</td></tr> <tr><td>I</td><td>\$3,259</td></tr> <tr><td>J</td><td>\$3,610</td></tr> <tr><td>L1</td><td>\$2,812</td></tr> <tr><td>L2</td><td>\$3,000</td></tr> </tbody> </table>	COM	\$2,073	A	\$2,099	B	\$2,152	COL/C	\$2,243	D	\$2,361	E	\$2,477	F	\$2,601	G	\$2,778	H	\$2,965	I	\$3,259	J	\$3,610	L1	\$2,812	L2	\$3,000		
COM	\$2,073																														
A	\$2,099																														
B	\$2,152																														
COL/C	\$2,243																														
D	\$2,361																														
E	\$2,477																														
F	\$2,601																														
G	\$2,778																														
H	\$2,965																														
I	\$3,259																														
J	\$3,610																														
L1	\$2,812																														
L2	\$3,000																														
Management Mid Back 	P09026 · regency arm, open wood arm · arm exterior is carved and shaped maple · seat height range is 17 ½ - 20 ¾ · arm height range is 21 - 24 ¼	<table border="1"> <thead> <tr> <th>Dimensions</th> <th>D</th> <th>W</th> <th>H</th> </tr> </thead> <tbody> <tr> <td>Overall</td> <td>28 ½</td> <td>25 ¼</td> <td>40 ¼</td> </tr> <tr> <td>Seat</td> <td>17 ½</td> <td>20 ½</td> <td>20 ¾</td> </tr> <tr> <td>Arm</td> <td></td> <td></td> <td>24 ¼</td> </tr> </tbody> </table>	Dimensions	D	W	H	Overall	28 ½	25 ¼	40 ¼	Seat	17 ½	20 ½	20 ¾	Arm			24 ¼	<table border="1"> <thead> <tr> <th colspan="2">Upholstery</th> <th colspan="2">Shipping</th> </tr> </thead> <tbody> <tr> <td>COM Ydg</td> <td>2 ¾</td> <td>Ctn Wt</td> <td>59</td> </tr> <tr> <td>COL Sq Ft</td> <td>50</td> <td>Cu Ft</td> <td>19</td> </tr> </tbody> </table>	Upholstery		Shipping		COM Ydg	2 ¾	Ctn Wt	59	COL Sq Ft	50	Cu Ft	19
		Dimensions	D	W	H																										
Overall	28 ½	25 ¼	40 ¼																												
Seat	17 ½	20 ½	20 ¾																												
Arm			24 ¼																												
Upholstery		Shipping																													
COM Ydg	2 ¾	Ctn Wt	59																												
COL Sq Ft	50	Cu Ft	19																												
			<table border="1"> <tbody> <tr><td>COM</td><td>\$1,907</td></tr> <tr><td>A</td><td>\$1,931</td></tr> <tr><td>B</td><td>\$1,980</td></tr> <tr><td>COL/C</td><td>\$2,064</td></tr> <tr><td>D</td><td>\$2,171</td></tr> <tr><td>E</td><td>\$2,278</td></tr> <tr><td>F</td><td>\$2,391</td></tr> <tr><td>G</td><td>\$2,553</td></tr> <tr><td>H</td><td>\$2,725</td></tr> <tr><td>I</td><td>\$2,994</td></tr> <tr><td>J</td><td>\$3,316</td></tr> <tr><td>L1</td><td>\$2,586</td></tr> <tr><td>L2</td><td>\$2,757</td></tr> </tbody> </table>	COM	\$1,907	A	\$1,931	B	\$1,980	COL/C	\$2,064	D	\$2,171	E	\$2,278	F	\$2,391	G	\$2,553	H	\$2,725	I	\$2,994	J	\$3,316	L1	\$2,586	L2	\$2,757		
COM	\$1,907																														
A	\$1,931																														
B	\$1,980																														
COL/C	\$2,064																														
D	\$2,171																														
E	\$2,278																														
F	\$2,391																														
G	\$2,553																														
H	\$2,725																														
I	\$2,994																														
J	\$3,316																														
L1	\$2,586																														
L2	\$2,757																														

To Order, Specify:

- ① Model Number
- ② Wood Species - Maple (M)
- ③ Wood Finish
- ④ Fabric Selection - vendor, pattern and color
- ⑤ Button/Reverse Diamond Detail - add \$139 list
- ③ Optional Conference Self - Return Swivel Mechanism - add \$112 list

③ Wood Finish Options:

ALE	Ale	FLX	Flax
AUB	Auburn	CGR	Graphite Coordinate
AUT	Autumn	CHL	High Line Coordinate
BRL	Barley	CKK	Khaki Coordinate
CBE	Blonde Echo Coordinate	LGC	Legacy
BBN	Bourbon	MCH	Mocha
CBZ	Brazilwood Coordinate	NTO	Night Owl
BRG	Brighton	PRL	Praline
BUT	Butterscotch	SAF	Saffron
CIN	Cinnamon	SIE	Sienna
CLA	Classic	CST	Studio Teak Coordinate
CCF	Coffee Coordinate	TOF	Toffee
CCR	Cremello Coordinate	TRF	Truffle
EAR	Earthy	VEN	Venetian
ESP	Espresso	CWH	Walnut Heights Coordinate

- ④ See a selection of graded in fabric manufacturers and patterns on pages 12-20. Contact Customer Service for additional fabric options.

Specifications

- Wood species - Maple.
- Seat has synthetic sheet webbing with high resiliency seat polyurethane foam and Dacron® wrap.
- Frame interior is hardwood joined with double dowels.
- Back has polypropylene webbing and polyurethane foam with Dacron® wrap.
- All backs have button/reverse diamond detail option.
- Adjustment is mid-pivot, mid-knee tilt with gas height adjustment.
- C706, wood base cap.
- C10, hooded black double wheel caster.
- Caster is hard tread.

Protocol Order Check List:



SWIVEL

Specify:

- 1. Model Number
- 2. Wood Species - Maple (M)
- 3. Arm Wood Cap/Crown Finish
- 4. Fabric Selection - vendor, pattern and color
- 5. Optional Aluminum Base - add \$84 list, or Optional Wood Base - add \$84 list
- 6. Optional Mid-Pivot Mechanism Upgrade - add \$108 list (swivel tilt models only)
- 7. Optional Seat Depth Slide - add \$31 (synchro models only)
- 8. Optional Conference Preset Height Cylinder - add \$23 list
- 9. Optional T Arm Wood Cap - add \$35 list

Example:

PT5600 (model #)	M (wood species)	AUB (finish) arm wood cap/crown	MOMENTUM (fabric vendor)	VOX (pattern name)	MYSTIC (pattern color)
---------------------	---------------------	---------------------------------------	-----------------------------	-----------------------	---------------------------

1. Model Number

- Special application instructions (e.g., all stripes will be applied front to back unless specified otherwise)
- Customer and purchase order number

2. Wood Species - Maple (M)

3. Arm Wood Cap/Crown Finish Options:

ALE Ale	FLX Flax
AUB Auburn	CGR Graphite Coordinate
AUT Autumn	CHL High Line Coordinate
BRL Barley	CKC Khaki Coordinate
CBE Blonde Echo Coordinate	LGC Legacy
BBN Bourbon	MCH Mocha
CBZ Brazilwood Coordinate	NTO Night Owl
BRG Brighton	PRL Praline
BUT Butterscotch	SAF Saffron
CIN Cinnamon	SIE Sienna
CLA Classic	CST Studio Teak Coordinate
CCF Coffee Coordinate	TOF Toffee
CCR Cremello Coordinate	TRF Truffle
EAR Earthy	VEN Venetian
ESP Espresso	CWH Walnut Heights Coordinate

Ship prepaid COM material to:
 JSI
 Attn: COM Dept
 932 Mill Street
 Jasper, IN 47546

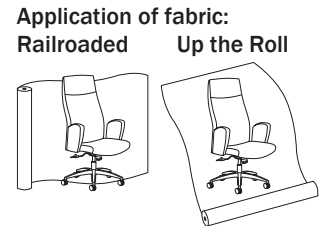

All COM orders will ship at standard lead time from receipt of COM except for orders requiring special custom matched finishes.

4. Fabric Selection - Please supply the following:

- Vendor name
- Pattern name
- Pattern color

When specifying contrasting upholstery, indicate clearly which upholstery is to be applied to the seat, back and arms. Use higher grade pricing.

- Indicate direction of fabric - Railroaded or Up the Roll
- Please provide illustration, if available

All COM orders must include the following:

- Vendor's name, pattern name and color
- Sample of the fabric attached to order
- Model numbers of items for fabric application

5. Optional Aluminum Base (A) - add \$84 list
Optional Wood Base (W) (seat height ranges from 16 3/4" to 20 1/2") - add \$84 list





6. Optional Mid-Pivot Mechanism Upgrade - add \$108 list (swivel tilt models only)

7. Optional Seat Depth Slide - add \$31 list (synchro models only)

8. Optional Conference Preset Height Cylinder - add \$23 list
 - arm height preset to 27"

9. Optional T Arm Wood Cap - add \$35 list

SWIVEL

Description	① Model	Specifications	List Price Per Grade																												
Management Mid Back 	PT5610 · synchro/adjustable height back · armless · polyurethane base · overall height range is 41 - 46 ½ · seat height range is 16 ½ - 22	<table border="1"> <thead> <tr> <th>Dimensions</th> <th>D</th> <th>W</th> <th>H</th> </tr> </thead> <tbody> <tr> <td>Overall</td> <td>26</td> <td>26</td> <td>46 ½</td> </tr> <tr> <td>Seat</td> <td>19 ¼</td> <td>19 ¼</td> <td>22</td> </tr> <tr> <th colspan="2">Upholstery</th> <th colspan="2">Shipping</th> </tr> <tr> <td>COM Ydg</td> <td>2 ¼</td> <td>Ctn Wt</td> <td>58</td> </tr> <tr> <td>COL Sq Ft</td> <td>41</td> <td>Cu Ft</td> <td>18</td> </tr> </tbody> </table>	Dimensions	D	W	H	Overall	26	26	46 ½	Seat	19 ¼	19 ¼	22	Upholstery		Shipping		COM Ydg	2 ¼	Ctn Wt	58	COL Sq Ft	41	Cu Ft	18	COM \$1,304 A \$1,323 B \$1,362 COL/C \$1,432 D \$1,519 E \$1,607 F \$1,700 G \$1,832 H \$1,972 I \$2,193 J \$2,456 L1 \$1,858 L2 \$1,999				
		Dimensions	D	W	H																										
Overall	26	26	46 ½																												
Seat	19 ¼	19 ¼	22																												
Upholstery		Shipping																													
COM Ydg	2 ¼	Ctn Wt	58																												
COL Sq Ft	41	Cu Ft	18																												
Management Mid Back 	PT5600 · swivel tilt/ fixed back · armless · polyurethane base · overall height range is 41 - 46 ½ · seat height range is 16 ½ - 22	<table border="1"> <thead> <tr> <th>Dimensions</th> <th>D</th> <th>W</th> <th>H</th> </tr> </thead> <tbody> <tr> <td>Overall</td> <td>26</td> <td>26</td> <td>46 ½</td> </tr> <tr> <td>Seat</td> <td>19 ¼</td> <td>19 ¼</td> <td>22</td> </tr> <tr> <th colspan="2">Upholstery</th> <th colspan="2">Shipping</th> </tr> <tr> <td>COM Ydg</td> <td>2 ¼</td> <td>Ctn Wt</td> <td>58</td> </tr> <tr> <td>COL Sq Ft</td> <td>41</td> <td>Cu Ft</td> <td>18</td> </tr> </tbody> </table>	Dimensions	D	W	H	Overall	26	26	46 ½	Seat	19 ¼	19 ¼	22	Upholstery		Shipping		COM Ydg	2 ¼	Ctn Wt	58	COL Sq Ft	41	Cu Ft	18	COM \$1,208 A \$1,228 B \$1,267 COL/C \$1,336 D \$1,423 E \$1,511 F \$1,605 G \$1,736 H \$1,877 I \$2,097 J \$2,361 L1 \$1,762 L2 \$1,903				
		Dimensions	D	W	H																										
Overall	26	26	46 ½																												
Seat	19 ¼	19 ¼	22																												
Upholstery		Shipping																													
COM Ydg	2 ¼	Ctn Wt	58																												
COL Sq Ft	41	Cu Ft	18																												
Management Mid Back 	PT5610T · synchro/adjustable height back · adjustable urethane T arm · polyurethane base · arm post matches base color · overall height range is 41 - 46 ½ · seat height range is 16 ½ - 22 · arm height range is 25 ½ - 31	<table border="1"> <thead> <tr> <th>Dimensions</th> <th>D</th> <th>W</th> <th>H</th> </tr> </thead> <tbody> <tr> <td>Overall</td> <td>26</td> <td>26</td> <td>46 ½</td> </tr> <tr> <td>Seat</td> <td>19 ¼</td> <td>19 ¼</td> <td>22</td> </tr> <tr> <td>Arm</td> <td></td> <td></td> <td>31</td> </tr> <tr> <th colspan="2">Upholstery</th> <th colspan="2">Shipping</th> </tr> <tr> <td>COM Ydg</td> <td>2 ¼</td> <td>Ctn Wt</td> <td>65</td> </tr> <tr> <td>COL Sq Ft</td> <td>41</td> <td>Cu Ft</td> <td>18</td> </tr> </tbody> </table>	Dimensions	D	W	H	Overall	26	26	46 ½	Seat	19 ¼	19 ¼	22	Arm			31	Upholstery		Shipping		COM Ydg	2 ¼	Ctn Wt	65	COL Sq Ft	41	Cu Ft	18	COM \$1,509 A \$1,529 B \$1,568 COL/C \$1,637 D \$1,725 E \$1,813 F \$1,906 G \$2,037 H \$2,178 I \$2,399 J \$2,662 L1 \$2,064 L2 \$2,204
		Dimensions	D	W	H																										
Overall	26	26	46 ½																												
Seat	19 ¼	19 ¼	22																												
Arm			31																												
Upholstery		Shipping																													
COM Ydg	2 ¼	Ctn Wt	65																												
COL Sq Ft	41	Cu Ft	18																												
Management Mid Back 	PT5600T · swivel tilt/ fixed back · adjustable urethane T arm · polyurethane base · arm post matches base color · overall height range is 41 - 46 ½ · seat height range is 16 ½ - 22 · arm height range is 25 ½ - 31	<table border="1"> <thead> <tr> <th>Dimensions</th> <th>D</th> <th>W</th> <th>H</th> </tr> </thead> <tbody> <tr> <td>Overall</td> <td>26</td> <td>26</td> <td>46 ½</td> </tr> <tr> <td>Seat</td> <td>19 ¼</td> <td>19 ¼</td> <td>22</td> </tr> <tr> <td>Arm</td> <td></td> <td></td> <td>31</td> </tr> <tr> <th colspan="2">Upholstery</th> <th colspan="2">Shipping</th> </tr> <tr> <td>COM Ydg</td> <td>2 ¼</td> <td>Ctn Wt</td> <td>65</td> </tr> <tr> <td>COL Sq Ft</td> <td>41</td> <td>Cu Ft</td> <td>18</td> </tr> </tbody> </table>	Dimensions	D	W	H	Overall	26	26	46 ½	Seat	19 ¼	19 ¼	22	Arm			31	Upholstery		Shipping		COM Ydg	2 ¼	Ctn Wt	65	COL Sq Ft	41	Cu Ft	18	COM \$1,417 A \$1,437 B \$1,476 COL/C \$1,545 D \$1,632 E \$1,720 F \$1,814 G \$1,945 H \$2,086 I \$2,306 J \$2,570 L1 \$1,971 L2 \$2,112
		Dimensions	D	W	H																										
Overall	26	26	46 ½																												
Seat	19 ¼	19 ¼	22																												
Arm			31																												
Upholstery		Shipping																													
COM Ydg	2 ¼	Ctn Wt	65																												
COL Sq Ft	41	Cu Ft	18																												

Description	Model	Specifications			List Price Per Grade	
Management Mid Back 	PT5610U • synchro/adjustable height back • fixed height upholstered arm • polyurethane base • overall height range is 41 - 46 1/2 • seat height range is 16 1/2 - 22 • arm height range is 25 1/2 - 31	Dimensions	D	W	H	COM \$1,641
		Overall	26	26	46 1/2	A \$1,668
		Seat	19 1/4	19 1/4	22	B \$1,722
		Arm			31	COL/C \$1,818
		Upholstery	Shipping			D \$1,940
		COM Ydg	3 1/8	Ctn Wt	64	E \$2,062
		COL Sq Ft	57	Cu Ft	18	F \$2,191
						G \$2,375
						H \$2,570
						I \$2,875
						J \$3,242
						L1 \$2,411
						L2 \$2,607

Management Mid Back 	PT5600U • swivel tilt/fixed back • fixed height upholstered arm • polyurethane base • overall height range is 41 - 46 1/2 • seat height range is 16 1/2 - 22 • arm height range is 25 1/2 - 31	Dimensions	D	W	H	COM \$1,439
		Overall	26	26	46 1/2	A \$1,466
		Seat	19 1/4	19 1/4	22	B \$1,521
		Arm			31	COL/C \$1,616
		Upholstery	Shipping			D \$1,738
		COM Ydg	3 1/8	Ctn Wt	64	E \$1,860
		COL Sq Ft	57	Cu Ft	18	F \$1,989
						G \$2,173
						H \$2,368
						I \$2,674
						J \$3,040
						L1 \$2,210
						L2 \$2,405

Executive High Back 	PT5615T • synchro/adjustable height back • adjustable urethane T arm • polyurethane base • arm post matches base color • overall height range is 46 - 51 1/2 • seat height range is 16 1/2 - 22 • arm height range is 25 1/2 - 31	Dimensions	D	W	H	COM \$1,575
		Overall	26	26	51 1/2	A \$1,598
		Seat	19 1/4	19 1/4	22	B \$1,642
		Arm			31	COL/C \$1,717
		Upholstery	Shipping			D \$1,815
		COM Ydg	2 1/2	Ctn Wt	68	E \$1,913
		COL Sq Ft	45	Cu Ft	18	F \$2,015
						G \$2,162
						H \$2,319
						I \$2,564
						J \$2,856
						L1 \$2,192
						L2 \$2,348

To Order, Specify:

- 1 Model Number
- 2 Wood Species - Maple (M)
- 3 Arm Wood Cap/Crown Finish
- 4 Fabric Selection - vendor, pattern and color
- 5 Optional Aluminum Base (A) - add \$84 list
Optional Wood Base (W) - add \$84 list
- 6 Optional Mid-Pivot Mechanism - add \$108 list
(swivel tilt models only)
- 7 Optional Seat Depth Slide - add \$31 list
(synchro models only)
- 8 Optional Conference Preset Height Cylinder - add \$23 list
- 9 Optional T Arm Wood Cap - add \$35 list

When ordering Quickship products, place a "Q" in front of model number.
Example: QGT4901D

NOW!
Need it.
JSI Quickship

3 Arm Wood Cap/Crown Finish Options:





- | | |
|----------------------------|-------------------------------|
| ALE Ale | FLX Flax |
| AUB Auburn | CGR Graphite Coordinate |
| AUT Autumn | CHL High Line Coordinate |
| BRL Barley | CKC Khaki Coordinate |
| CBE Blonde Echo Coordinate | LGC Legacy |
| BBN Bourbon | MCH Mocha |
| CBZ Brazilwood Coordinate | NTO Night Owl |
| BRG Brighton | PRL Praline |
| BUT Butterscotch | SAF Saffron |
| CIN Cinnamon | SIE Sienna |
| CLA Classic | CST Studio Teak Coordinate |
| CCF Coffee Coordinate | TOF Toffee |
| CCR Cremello Coordinate | TRF Truffle |
| EAR Earthy | VEN Venetian |
| ESP Espresso | CWH Walnut Heights Coordinate |

- 4 See a selection of graded in fabric manufacturers and patterns on pages 12-20. Contact Customer Service for additional fabric options.

Specifications

- Wood species - Maple.
- Two piece molded plywood seat and back.
- Base has 2" to 1" tapered high density polyurethane foam with 1/4" overlay.
- Seat has 3 1/2" high density polyurethane foam.
- Swivel tilt models are standard with tilt, lock, pneumatic lift, tension adjustment.
- Synchro models are standard with synchronized independent seat and back recline, lock, pneumatic lift, tensions adjustment, 6 position, 2 1/2" back height adjustment.
- Polyurethane base - glass reinforced nylon / 5-prong / grip ring caster insertion.
- All models standard with 60 mm dual wheel non-hooded black nylon plastic casters.

SWIVEL

Description	① Model	Specifications	List Price Per Grade																												
Executive High Back 	PT5605T · swivel tilt/fixed back · adjustable urethane T arm · polyurethane base · arm post matches base color · overall height range is 46-51 1/2 · seat height range is 16 1/2-22 · arm height range is 25 1/2-31	<table border="1"> <thead> <tr> <th>Dimensions</th> <th>D</th> <th>W</th> <th>H</th> </tr> </thead> <tbody> <tr> <td>Overall</td> <td>26</td> <td>26</td> <td>51 1/2</td> </tr> <tr> <td>Seat</td> <td>19 1/4</td> <td>19 1/4</td> <td>22</td> </tr> <tr> <td>Arm</td> <td></td> <td></td> <td>31</td> </tr> <tr> <th colspan="2">Upholstery</th> <th colspan="2">Shipping</th> </tr> <tr> <td>COM Ydg</td> <td>2 1/2</td> <td>Ctn Wt</td> <td>68</td> </tr> <tr> <td>COL Sq Ft</td> <td>45</td> <td>Cu Ft</td> <td>18</td> </tr> </tbody> </table>	Dimensions	D	W	H	Overall	26	26	51 1/2	Seat	19 1/4	19 1/4	22	Arm			31	Upholstery		Shipping		COM Ydg	2 1/2	Ctn Wt	68	COL Sq Ft	45	Cu Ft	18	COM \$1,488 A \$1,510 B \$1,554 COL/C \$1,630 D \$1,728 E \$1,825 F \$1,928 G \$2,075 H \$2,232 I \$2,476 J \$2,769 L1 \$2,105 L2 \$2,261
		Dimensions	D	W	H																										
Overall	26	26	51 1/2																												
Seat	19 1/4	19 1/4	22																												
Arm			31																												
Upholstery		Shipping																													
COM Ydg	2 1/2	Ctn Wt	68																												
COL Sq Ft	45	Cu Ft	18																												
Executive High Back 	PT5615U · synchro/adjustable height back · upholstered arm · polyurethane base · overall height range is 46-51 1/2 · seat height range is 16 1/2-22 · arm height range is 25 1/2-31	<table border="1"> <thead> <tr> <th>Dimensions</th> <th>D</th> <th>W</th> <th>H</th> </tr> </thead> <tbody> <tr> <td>Overall</td> <td>26</td> <td>26</td> <td>51 1/2</td> </tr> <tr> <td>Seat</td> <td>19 1/4</td> <td>19 1/4</td> <td>22</td> </tr> <tr> <td>Arm</td> <td></td> <td></td> <td>31</td> </tr> <tr> <th colspan="2">Upholstery</th> <th colspan="2">Shipping</th> </tr> <tr> <td>COM Ydg</td> <td>3 1/4</td> <td>Ctn Wt</td> <td>67</td> </tr> <tr> <td>COL Sq Ft</td> <td>59</td> <td>Cu Ft</td> <td>18</td> </tr> </tbody> </table>	Dimensions	D	W	H	Overall	26	26	51 1/2	Seat	19 1/4	19 1/4	22	Arm			31	Upholstery		Shipping		COM Ydg	3 1/4	Ctn Wt	67	COL Sq Ft	59	Cu Ft	18	COM \$1,701 A \$1,731 B \$1,787 COL/C \$1,885 D \$2,012 E \$2,139 F \$2,274 G \$2,465 H \$2,667 I \$2,986 J \$3,367 L1 \$2,503 L2 \$2,705
		Dimensions	D	W	H																										
Overall	26	26	51 1/2																												
Seat	19 1/4	19 1/4	22																												
Arm			31																												
Upholstery		Shipping																													
COM Ydg	3 1/4	Ctn Wt	67																												
COL Sq Ft	59	Cu Ft	18																												
Executive High Back 	PT5605U · swivel tilt/fixed back · upholstered arm · polyurethane base · overall height range is 46-51 1/2 · seat height range is 16 1/2-22 · arm height range is 25 1/2-31	<table border="1"> <thead> <tr> <th>Dimensions</th> <th>D</th> <th>W</th> <th>H</th> </tr> </thead> <tbody> <tr> <td>Overall</td> <td>26</td> <td>26</td> <td>51 1/2</td> </tr> <tr> <td>Seat</td> <td>19 1/4</td> <td>19 1/4</td> <td>22</td> </tr> <tr> <td>Arm</td> <td></td> <td></td> <td>31</td> </tr> <tr> <th colspan="2">Upholstery</th> <th colspan="2">Shipping</th> </tr> <tr> <td>COM Ydg</td> <td>3 1/4</td> <td>Ctn Wt</td> <td>67</td> </tr> <tr> <td>COL Sq Ft</td> <td>59</td> <td>Cu Ft</td> <td>18</td> </tr> </tbody> </table>	Dimensions	D	W	H	Overall	26	26	51 1/2	Seat	19 1/4	19 1/4	22	Arm			31	Upholstery		Shipping		COM Ydg	3 1/4	Ctn Wt	67	COL Sq Ft	59	Cu Ft	18	COM \$1,624 A \$1,653 B \$1,709 COL/C \$1,808 D \$1,935 E \$2,062 F \$2,196 G \$2,387 H \$2,590 I \$2,908 J \$3,289 L1 \$2,425 L2 \$2,628
		Dimensions	D	W	H																										
Overall	26	26	51 1/2																												
Seat	19 1/4	19 1/4	22																												
Arm			31																												
Upholstery		Shipping																													
COM Ydg	3 1/4	Ctn Wt	67																												
COL Sq Ft	59	Cu Ft	18																												
Management Mid Back 	PT5660 · solid maple crown · synchro/adjustable height back · armless · polyurethane base · overall height range is 41-46 1/2 · seat height range is 16 1/2-22	<table border="1"> <thead> <tr> <th>Dimensions</th> <th>D</th> <th>W</th> <th>H</th> </tr> </thead> <tbody> <tr> <td>Overall</td> <td>26</td> <td>26</td> <td>46 1/2</td> </tr> <tr> <td>Seat</td> <td>19 1/4</td> <td>19 1/4</td> <td>22</td> </tr> <tr> <th colspan="2">Upholstery</th> <th colspan="2">Shipping</th> </tr> <tr> <td>COM Ydg</td> <td>2 1/8</td> <td>Ctn Wt</td> <td>59</td> </tr> <tr> <td>COL Sq Ft</td> <td>39</td> <td>Cu Ft</td> <td>18</td> </tr> </tbody> </table>	Dimensions	D	W	H	Overall	26	26	46 1/2	Seat	19 1/4	19 1/4	22	Upholstery		Shipping		COM Ydg	2 1/8	Ctn Wt	59	COL Sq Ft	39	Cu Ft	18	COM \$1,444 A \$1,463 B \$1,500 COL/C \$1,565 D \$1,648 E \$1,731 F \$1,819 G \$1,943 H \$2,076 I \$2,284 J \$2,533 L1 \$1,968 L2 \$2,102				
		Dimensions	D	W	H																										
Overall	26	26	46 1/2																												
Seat	19 1/4	19 1/4	22																												
Upholstery		Shipping																													
COM Ydg	2 1/8	Ctn Wt	59																												
COL Sq Ft	39	Cu Ft	18																												

Specification information shown at right.

Description	Model	Specifications				List Price Per Grade	
		Dimensions	D	W	H	COM	
Management Mid Back 	PT5650 • solid maple crown • swivel tilt/ fixed back • armless • polyurethane base • overall height range is 41 - 46½ • seat height range is 16½ - 22	Overall	26	26	46½	COM	\$1,349
		Seat	19¼	19¼	22	A	\$1,368
		Upholstery		Shipping		B	\$1,404
		COM Ydg	2⅞	Ctn Wt	59	COL/C	\$1,469
		COL Sq Ft	39	Cu Ft	18	D	\$1,552
						E	\$1,635
						F	\$1,724
						G	\$1,847
						H	\$1,981
						I	\$2,189
						J	\$2,438
						L1	\$1,873
						L2	\$2,006

Description	Model	Specifications				List Price Per Grade	
		Dimensions	D	W	H	COM	
Management Mid Back 	PT5660T • solid maple crown • synchro/ adjustable height back • adjustable urethane T arm • polyurethane base • arm post matches base color • overall height range is 41 - 46½ • seat height range is 16½ - 22 • arm height range is 25½ - 31	Overall	26	26	46½	COM	\$1,651
		Seat	19¼	19¼	22	A	\$1,670
		Arm		31		B	\$1,707
		Upholstery		Shipping		COL/C	\$1,772
		COM Ydg	2⅞	Ctn Wt	68	D	\$1,855
		COL Sq Ft	39	Cu Ft	18	E	\$1,938
						F	\$2,026
						G	\$2,150
						H	\$2,283
						I	\$2,491
						J	\$2,740
						L1	\$2,175
						L2	\$2,308

Description	Model	Specifications				List Price Per Grade	
		Dimensions	D	W	H	COM	
Management Mid Back 	PT5650T • solid maple crown • swivel tilt/ fixed back • adjustable urethane T arm • polyurethane base • arm post matches base color • overall height range is 41 - 46½ • seat height range is 16½ - 22 • arm height range is 25½ - 31	Overall	26	26	46½	COM	\$1,553
		Seat	19¼	19¼	22	A	\$1,572
		Arm		31		B	\$1,609
		Upholstery		Shipping		COL/C	\$1,674
		COM Ydg	2⅞	Ctn Wt	68	D	\$1,757
		COL Sq Ft	39	Cu Ft	18	E	\$1,840
						F	\$1,928
						G	\$2,052
						H	\$2,186
						I	\$2,393
						J	\$2,642
						L1	\$2,077
						L2	\$2,211

To Order, Specify:

- 1 Model Number
- 2 Wood Species - Maple (M)
- 3 Arm Wood Cap/Crown Finish
- 4 Fabric Selection - vendor, pattern and color
- 5 Optional Aluminum Base (A) - add \$84 list
Optional Wood Base (W) - add \$84 list
- 6 Optional Mid-Pivot Mechanism - add \$108 list
(swivel tilt models only)
- 7 Optional Seat Depth Slide - add \$31 list
(synchro models only)
- 8 Optional Conference Preset Height Cylinder - add \$23 list
- 9 Optional T Arm Wood Cap - add \$35 list

When ordering Quickship products, place a "Q" in front of model number.
Example: QGT4901D

NOW!
Need it.
JSI Quickship

3 Arm Wood Cap/Crown Finish Options:





- | | |
|----------------------------|-------------------------------|
| ALE Ale | FLX Flax |
| AUB Auburn | CGR Graphite Coordinate |
| AUT Autumn | CHL High Line Coordinate |
| BRL Barley | CKC Khaki Coordinate |
| CBE Blonde Echo Coordinate | LGC Legacy |
| BBN Bourbon | MCH Mocha |
| CBZ Brazilwood Coordinate | NTO Night Owl |
| BRG Brighton | PRL Praline |
| BUT Butterscotch | SAF Saffron |
| CIN Cinnamon | SIE Sienna |
| CLA Classic | CST Studio Teak Coordinate |
| CCF Coffee Coordinate | TOF Toffee |
| CCR Cremello Coordinate | TRF Truffle |
| EAR Earthy | VEN Venetian |
| ESP Espresso | CWH Walnut Heights Coordinate |

- 4 See a selection of graded in fabric manufacturers and patterns on pages 12-20. Contact Customer Service for additional fabric options.

Specifications

- Wood species - Maple.
- Two piece molded plywood seat and back.
- Base has 2" to 1" tapered high density polyurethane foam with ¼" overlay.
- Seat has 3½" high density polyurethane foam.
- Swivel tilt models are standard with tilt, lock, pneumatic lift, tension adjustment.
- Synchro models are standard with synchronized independent seat and back recline, lock, pneumatic lift, tensions adjustment, 6 position, 2½" back height adjustment.
- Polyurethane base - glass reinforced nylon / 5-prong / grip ring caster insertion.
- All models standard with 60 mm dual wheel non-hooded black nylon plastic casters.

SWIVEL

Description	① Model	Specifications	List Price Per Grade																												
Management Mid Back 	PT5660U · solid maple crown · synchro/adjustable height back · fixed height upholstered arm · polyurethane base · overall height range is 41 - 46 ½ · seat height range is 16 ½ - 22 · arm height range is 25 ½ - 31	<table border="1"> <thead> <tr> <th>Dimensions</th> <th>D</th> <th>W</th> <th>H</th> </tr> </thead> <tbody> <tr> <td>Overall</td> <td>26</td> <td>26</td> <td>46 ½</td> </tr> <tr> <td>Seat</td> <td>19 ¼</td> <td>19 ¼</td> <td>22</td> </tr> <tr> <td>Arm</td> <td colspan="3">31</td> </tr> <tr> <th colspan="2">Upholstery</th> <th colspan="2">Shipping</th> </tr> <tr> <td>COM Ydg</td> <td>3</td> <td>Ctn Wt</td> <td>67</td> </tr> <tr> <td>COL Sq Ft</td> <td>54</td> <td>Cu Ft</td> <td>18</td> </tr> </tbody> </table>	Dimensions	D	W	H	Overall	26	26	46 ½	Seat	19 ¼	19 ¼	22	Arm	31			Upholstery		Shipping		COM Ydg	3	Ctn Wt	67	COL Sq Ft	54	Cu Ft	18	COM \$1,782 A \$1,809 B \$1,861 COL/C \$1,952 D \$2,070 E \$2,187 F \$2,310 G \$2,487 H \$2,674 I \$2,968 J \$3,320 L1 \$2,522 L2 \$2,709
		Dimensions	D	W	H																										
Overall	26	26	46 ½																												
Seat	19 ¼	19 ¼	22																												
Arm	31																														
Upholstery		Shipping																													
COM Ydg	3	Ctn Wt	67																												
COL Sq Ft	54	Cu Ft	18																												
Management Mid Back 	PT5650U · solid maple crown · swivel tilt/fixed back · fixed height upholstered arm · polyurethane base · overall height range is 41 - 46 ½ · seat height range is 16 ½ - 22 · arm height range is 25 ½ - 31	<table border="1"> <thead> <tr> <th>Dimensions</th> <th>D</th> <th>W</th> <th>H</th> </tr> </thead> <tbody> <tr> <td>Overall</td> <td>26</td> <td>26</td> <td>46 ½</td> </tr> <tr> <td>Seat</td> <td>19 ¼</td> <td>19 ¼</td> <td>22</td> </tr> <tr> <td>Arm</td> <td colspan="3">31</td> </tr> <tr> <th colspan="2">Upholstery</th> <th colspan="2">Shipping</th> </tr> <tr> <td>COM Ydg</td> <td>3</td> <td>Ctn Wt</td> <td>67</td> </tr> <tr> <td>COL Sq Ft</td> <td>54</td> <td>Cu Ft</td> <td>18</td> </tr> </tbody> </table>	Dimensions	D	W	H	Overall	26	26	46 ½	Seat	19 ¼	19 ¼	22	Arm	31			Upholstery		Shipping		COM Ydg	3	Ctn Wt	67	COL Sq Ft	54	Cu Ft	18	COM \$1,684 A \$1,710 B \$1,762 COL/C \$1,854 D \$1,971 E \$2,088 F \$2,212 G \$2,388 H \$2,575 I \$2,869 J \$3,221 L1 \$2,423 L2 \$2,611
		Dimensions	D	W	H																										
Overall	26	26	46 ½																												
Seat	19 ¼	19 ¼	22																												
Arm	31																														
Upholstery		Shipping																													
COM Ydg	3	Ctn Wt	67																												
COL Sq Ft	54	Cu Ft	18																												
Executive High Back 	PT5665T · solid maple crown · synchro/adjustable height back · adjustable urethane T arm · polyurethane base · arm post matches base color · overall height range is 46 - 51 ½ · seat height range is 16 ½ - 22 · arm height range is 25 ½ - 31	<table border="1"> <thead> <tr> <th>Dimensions</th> <th>D</th> <th>W</th> <th>H</th> </tr> </thead> <tbody> <tr> <td>Overall</td> <td>26</td> <td>26</td> <td>51 ½</td> </tr> <tr> <td>Seat</td> <td>19 ¼</td> <td>19 ¼</td> <td>22</td> </tr> <tr> <td>Arm</td> <td colspan="3">31</td> </tr> <tr> <th colspan="2">Upholstery</th> <th colspan="2">Shipping</th> </tr> <tr> <td>COM Ydg</td> <td>2 ½</td> <td>Ctn Wt</td> <td>69</td> </tr> <tr> <td>COL Sq Ft</td> <td>45</td> <td>Cu Ft</td> <td>18</td> </tr> </tbody> </table>	Dimensions	D	W	H	Overall	26	26	51 ½	Seat	19 ¼	19 ¼	22	Arm	31			Upholstery		Shipping		COM Ydg	2 ½	Ctn Wt	69	COL Sq Ft	45	Cu Ft	18	COM \$1,712 A \$1,734 B \$1,778 COL/C \$1,854 D \$1,951 E \$2,049 F \$2,152 G \$2,299 H \$2,455 I \$2,700 J \$2,993 L1 \$2,328 L2 \$2,485
		Dimensions	D	W	H																										
Overall	26	26	51 ½																												
Seat	19 ¼	19 ¼	22																												
Arm	31																														
Upholstery		Shipping																													
COM Ydg	2 ½	Ctn Wt	69																												
COL Sq Ft	45	Cu Ft	18																												
Executive High Back 	PT5655T · solid maple crown · swivel tilt/fixed back · adjustable urethane T arm · polyurethane base · arm post matches base color · overall height range is 46 - 51 ½ · seat height range is 16 ½ - 22 · arm height range is 25 ½ - 31	<table border="1"> <thead> <tr> <th>Dimensions</th> <th>D</th> <th>W</th> <th>H</th> </tr> </thead> <tbody> <tr> <td>Overall</td> <td>26</td> <td>26</td> <td>51 ½</td> </tr> <tr> <td>Seat</td> <td>19 ¼</td> <td>19 ¼</td> <td>22</td> </tr> <tr> <td>Arm</td> <td colspan="3">31</td> </tr> <tr> <th colspan="2">Upholstery</th> <th colspan="2">Shipping</th> </tr> <tr> <td>COM Ydg</td> <td>2 ½</td> <td>Ctn Wt</td> <td>69</td> </tr> <tr> <td>COL Sq Ft</td> <td>45</td> <td>Cu Ft</td> <td>18</td> </tr> </tbody> </table>	Dimensions	D	W	H	Overall	26	26	51 ½	Seat	19 ¼	19 ¼	22	Arm	31			Upholstery		Shipping		COM Ydg	2 ½	Ctn Wt	69	COL Sq Ft	45	Cu Ft	18	COM \$1,636 A \$1,658 B \$1,703 COL/C \$1,778 D \$1,876 E \$1,973 F \$2,076 G \$2,223 H \$2,380 I \$2,624 J \$2,917 L1 \$2,253 L2 \$2,409
		Dimensions	D	W	H																										
Overall	26	26	51 ½																												
Seat	19 ¼	19 ¼	22																												
Arm	31																														
Upholstery		Shipping																													
COM Ydg	2 ½	Ctn Wt	69																												
COL Sq Ft	45	Cu Ft	18																												

Description	Model	Specifications				List Price Per Grade	
		Dimensions	D	W	H	COM	
Executive High Back 	PT5665U • solid maple crown • synchro/adjustable height back • fixed height upholstered arm • polyurethane base • overall height range is 46 - 51 1/2 • seat height range is 16 1/2 - 22 • arm height range is 25 1/2 - 31	Overall	26	26	51 1/2	COM	\$1,839
		Seat	19 1/4	19 1/4	22	COL/C	\$2,023
		Arm			31	D	\$2,150
		Upholstery		Shipping		E	\$2,277
		COM Ydg	3 1/4	Ctn Wt	68	F	\$2,411
		COL Sq Ft	59	Cu Ft	18	G	\$2,602
						H	\$2,805
						I	\$3,123
						J	\$3,504
						L1	\$2,640
				L2	\$2,843		

Description	Model	Specifications				List Price Per Grade	
		Dimensions	D	W	H	COM	
Executive High Back 	PT5655U • solid maple crown • swivel tilt/fixed back • fixed height upholstered arm • polyurethane base • overall height range is 46 - 51 1/2 • seat height range is 16 1/2 - 22 • arm height range is 25 1/2 - 31	Overall	26	26	51 1/2	COM	\$1,774
		Seat	19 1/4	19 1/4	22	COL/C	\$1,958
		Arm			31	D	\$2,085
		Upholstery		Shipping		E	\$2,212
		COM Ydg	3 1/4	Ctn Wt	68	F	\$2,346
		COL Sq Ft	59	Cu Ft	18	G	\$2,537
						H	\$2,740
						I	\$3,058
						J	\$3,439
						L1	\$2,575
				L2	\$2,778		

To Order, Specify:

- 1 Model Number
- 2 Wood Species - Maple (M)
- 3 Arm Wood Cap/Crown Finish
- 4 Fabric Selection - vendor, pattern and color
- 5 Optional Aluminum Base (A) - add \$84 list
Optional Wood Base (W) - add \$84 list
- 6 Optional Mid-Pivot Mechanism - add \$108 list
(swivel tilt models only)
- 7 Optional Seat Depth Slide - add \$31 list
(synchro models only)
- 8 Optional Conference Preset Height Cylinder - add \$23 list
- 9 Optional T Arm Wood Cap - add \$35 list

When ordering Quickship products, place a "Q" in front of model number.
 Example: QGT4901D

NOW!
 Need it.
 JSI Quickship

3 Arm Wood Cap/Crown Finish Options:

- | | |
|----------------------------|-------------------------------|
| ALE Ale | FLX Flax |
| AUB Auburn | CGR Graphite Coordinate |
| AUT Autumn | CHL High Line Coordinate |
| BRL Barley | CKC Khaki Coordinate |
| CBE Blonde Echo Coordinate | LGC Legacy |
| BBN Bourbon | MCH Mocha |
| CBZ Brazilwood Coordinate | NTO Night Owl |
| BRG Brighton | PRL Praline |
| BUT Butterscotch | SAF Saffron |
| CIN Cinnamon | SIE Sienna |
| CLA Classic | CST Studio Teak Coordinate |
| CCF Coffee Coordinate | TOF Toffee |
| CCR Cremello Coordinate | TRF Truffle |
| EAR Earthy | VEN Venetian |
| ESP Espresso | CWH Walnut Heights Coordinate |

- 4 See a selection of graded in fabric manufacturers and patterns on pages 12-20. Contact Customer Service for additional fabric options.

Specifications

- Wood species - Maple.
- Two piece molded plywood seat and back.
- Base has 2" to 1" tapered high density polyurethane foam with 1/4" overlay.
- Seat has 3 1/2" high density polyurethane foam.
- Swivel tilt models are standard with tilt, lock, pneumatic lift, tension adjustment.
- Synchro models are standard with synchronized independent seat and back recline, lock, pneumatic lift, tensions adjustment, 6 position, 2 1/2" back height adjustment.
- Polyurethane base - glass reinforced nylon / 5-prong / grip ring caster insertion.
- All models standard with 60 mm dual wheel non-hooded black nylon plastic casters.

Proxy Order Check List:



SWIVEL

Specify:

- 1. Model Number
- 2. Seat Fabric Selection - vendor, pattern and color
- 3. Knit Back Color Selection
- 4. Optional Aluminum Base - add \$84 list,
- 5. Optional Seat Depth Slide - add \$31 list (synchro tilt models only)
- 6. Optional Metal Handle - Black Sandtex (BSX) add \$47 list, Nearly Chrome (NCH) add \$61 list

Example:

PX810T (model #)	MOMENTUM (fabric vendor)	VOX (pattern name)	MYSTIC (pattern color)	WR (knit color)
----------------------------	------------------------------------	------------------------------	----------------------------------	---------------------------

1. Model Number

2. Fabric Selection - Please supply the following:

- Vendor name
- Pattern name
- Pattern color

- Indicate direction of fabric - Railroaded or Up the Roll
- Please provide illustration, if available

All COM orders must include the following:

- Vendor's name, pattern name and color
- Sample of the fabric attached to order
- Model numbers of items for fabric application
- Special application instructions (e.g., all stripes will be applied front to back unless specified otherwise)
- Customer and purchase order number

Ship prepaid COM material to:
 JSI
 Attn: COM Dept
 932 Mill Street
 Jasper, IN 47546

Application of fabric:
 Railroaded Up the Roll



All COM orders will ship at standard lead time from receipt of COM.

3. Knit Back Color Selection:

BA	Barely Blue	RR	Rockin' Red
DA	Dancing Silver	SB	Sandy Beige
JB	Jet Black	WR	White River

4. Optional Aluminum Base - add \$84 list





5 Optional Seat Depth Slide - add \$31 list (synchro tilt models only)

6. Optional Metal Handle - Black Sandtex (BSX) add \$47 list or Nearly Chrome (NCH) add \$61 list



Description	① Model	Specifications				List Price Per Grade	
		Dimensions	D	W	H	COM	
Management Mid Back 	PX800 <ul style="list-style-type: none"> knit back armless swivel tilt black polyurethane base overall height range is 39 13/16 - 45 1/4 seat height range is 16 15/16 - 19 3/4 	Overall	28 1/2	28 1/2	45 1/4	COM	\$794
		Seat	16 5/8	20 3/4	19 3/4	COL/C	\$854
		Arm			D	\$888	
		Upholstery		Shipping		E	\$920
		COM Ydg	3/4	Ctn Wt	41	F	\$972
		COL Sq Ft	14	Cu Ft	20	G	\$1,026
						H	\$1,085
						I	\$1,176
						J	\$1,287
						L1	\$1,038
						L2	\$1,097

Description	① Model	Specifications				List Price Per Grade	
		Dimensions	D	W	H	COM	
Management Mid Back 	PX810 <ul style="list-style-type: none"> knit back armless synchro tilt black polyurethane base overall height range is 39 13/16 - 45 1/4 seat height range is 16 15/16 - 19 3/4 	Overall	28 1/2	28 1/2	45 1/4	COM	\$864
		Seat	16 5/8	20 3/4	19 3/4	COL/C	\$924
		Arm			D	\$958	
		Upholstery		Shipping		E	\$991
		COM Ydg	3/4	Ctn Wt	46	F	\$1,042
		COL Sq Ft	14	Cu Ft	20	G	\$1,097
						H	\$1,155
						I	\$1,247
						J	\$1,357
						L1	\$1,108
						L2	\$1,167

Description	① Model	Specifications				List Price Per Grade	
		Dimensions	D	W	H	COM	
Management Mid Back 	PX800L <ul style="list-style-type: none"> knit back swivel tilt black urethane loop arms black polyurethane base overall height range is 39 13/16 - 45 1/4 seat height range is 16 15/16 - 19 3/4 arm height range is 26 1/2 - 31 15/16 	Overall	28 1/2	28 1/2	45 1/4	COM	\$915
		Seat	16 5/8	20 3/4	19 3/4	COL/C	\$977
		Arm		31 15/16	D	\$1,010	
		Upholstery		Shipping		E	\$1,043
		COM Ydg	3/4	Ctn Wt	44	F	\$1,095
		COL Sq Ft	14	Cu Ft	20	G	\$1,149
						H	\$1,208
						I	\$1,299
						J	\$1,410
						L1	\$1,160
						L2	\$1,218

To Order, Specify:

- Model Number
- Seat Fabric Selection - vendor, pattern and color
- Knit Back Color Selection
- Optional Aluminum Base - add \$84 list
- Optional Seat Depth Slide - add \$31 list (synchro tilt models only)
- Optional Metal Handle - Black Sandtex (BSX) add \$47 list, Nearly Chrome (NCH) add \$61 list

- See a selection of graded in fabric manufacturers and patterns on pages 12-20. Contact Customer Service for additional fabric options.



③ Knit Color Selection:

BA	Barely Blue	RR	Rockin' Red
DA	Dancing Silver	SB	Sandy Beige
JB	Jet Black	WR	White River

Specifications

- Molded plywood seat.
- Seat has 2" high density polyurethane foam.
- Knit back conforms to shape of back for optimal comfort.
- Swivel tilt models are standard with tilt, lock, pneumatic lift, tension adjustment.
- Synchro models are standard with synchronized independent seat and back recline, lock, pneumatic lift, tensions adjustment, 6 position.
- Polyurethane base, glass reinforced nylon/5-prong/grip ring caster insertion.
- All models standard with 60 mm dual wheel non-hooded black nylon plastic casters.

SWIVEL

Description	① Model	Specifications	List Price Per Grade																
Management Mid Back 	PX810L · knit back · synchro tilt · black urethane loop arms · black polyurethane base · overall height range is 39 13/16 - 45 1/4 · seat height range is 16 15/16 - 19 3/4 · arm height range is 26 1/2 - 31 15/16	<table border="1"> <thead> <tr> <th>Dimensions</th> <th>D</th> <th>W</th> <th>H</th> </tr> </thead> <tbody> <tr> <td>Overall</td> <td>28 1/2</td> <td>28 1/2</td> <td>45 1/4</td> </tr> <tr> <td>Seat</td> <td>16 5/8</td> <td>20 3/4</td> <td>19 3/4</td> </tr> <tr> <td>Arm</td> <td colspan="3">31 15/16</td> </tr> </tbody> </table>	Dimensions	D	W	H	Overall	28 1/2	28 1/2	45 1/4	Seat	16 5/8	20 3/4	19 3/4	Arm	31 15/16			COM \$984 A \$1,007 B \$1,021 COL/C \$1,047 D \$1,080 E \$1,113 F \$1,165 G \$1,220 H \$1,278 I \$1,370 J \$1,480 L1 \$1,230 L2 \$1,289
		Dimensions	D	W	H														
Overall	28 1/2	28 1/2	45 1/4																
Seat	16 5/8	20 3/4	19 3/4																
Arm	31 15/16																		
<table border="1"> <thead> <tr> <th>Upholstery</th> <th colspan="3">Shipping</th> </tr> </thead> <tbody> <tr> <td>COM Ydg</td> <td>3/4</td> <td>Ctn Wt</td> <td>49</td> </tr> <tr> <td>COL Sq Ft</td> <td>14</td> <td>Cu Ft</td> <td>20</td> </tr> </tbody> </table>	Upholstery	Shipping			COM Ydg	3/4	Ctn Wt	49	COL Sq Ft	14	Cu Ft	20							
Upholstery	Shipping																		
COM Ydg	3/4	Ctn Wt	49																
COL Sq Ft	14	Cu Ft	20																
Management Mid Back 	PX800T · knit back · swivel tilt · adjustable black urethane T arm · black polyurethane base · arm post matches base color · overall height range is 39 13/16 - 45 1/4 · seat height range is 16 15/16 - 19 3/4 · arm height range is 30 13/16 - 33 7/8	<table border="1"> <thead> <tr> <th>Dimensions</th> <th>D</th> <th>W</th> <th>H</th> </tr> </thead> <tbody> <tr> <td>Overall</td> <td>28 1/2</td> <td>28 1/2</td> <td>45 1/4</td> </tr> <tr> <td>Seat</td> <td>16 5/8</td> <td>20 3/4</td> <td>19 3/4</td> </tr> <tr> <td>Arm</td> <td colspan="3">33 7/8</td> </tr> </tbody> </table>	Dimensions	D	W	H	Overall	28 1/2	28 1/2	45 1/4	Seat	16 5/8	20 3/4	19 3/4	Arm	33 7/8			COM \$962 A \$984 B \$999 COL/C \$1,025 D \$1,058 E \$1,090 F \$1,142 G \$1,197 H \$1,256 I \$1,348 J \$1,457 L1 \$1,208 L2 \$1,267
		Dimensions	D	W	H														
Overall	28 1/2	28 1/2	45 1/4																
Seat	16 5/8	20 3/4	19 3/4																
Arm	33 7/8																		
<table border="1"> <thead> <tr> <th>Upholstery</th> <th colspan="3">Shipping</th> </tr> </thead> <tbody> <tr> <td>COM Ydg</td> <td>3/4</td> <td>Ctn Wt</td> <td>47</td> </tr> <tr> <td>COL Sq Ft</td> <td>14</td> <td>Cu Ft</td> <td>20</td> </tr> </tbody> </table>	Upholstery	Shipping			COM Ydg	3/4	Ctn Wt	47	COL Sq Ft	14	Cu Ft	20							
Upholstery	Shipping																		
COM Ydg	3/4	Ctn Wt	47																
COL Sq Ft	14	Cu Ft	20																
Management Mid Back 	PX810T · knit back · synchro tilt · adjustable black urethane T arm · black polyurethane base · arm post matches base color · overall height range is 39 13/16 - 45 1/4 · seat height range is 16 15/16 - 19 3/4 · arm height range is 30 13/16 - 33 7/8	<table border="1"> <thead> <tr> <th>Dimensions</th> <th>D</th> <th>W</th> <th>H</th> </tr> </thead> <tbody> <tr> <td>Overall</td> <td>28 1/2</td> <td>28 1/2</td> <td>45 1/4</td> </tr> <tr> <td>Seat</td> <td>16 5/8</td> <td>20 3/4</td> <td>19 3/4</td> </tr> <tr> <td>Arm</td> <td colspan="3">33 7/8</td> </tr> </tbody> </table>	Dimensions	D	W	H	Overall	28 1/2	28 1/2	45 1/4	Seat	16 5/8	20 3/4	19 3/4	Arm	33 7/8			COM \$1,032 A \$1,055 B \$1,069 COL/C \$1,096 D \$1,128 E \$1,161 F \$1,212 G \$1,268 H \$1,326 I \$1,418 J \$1,527 L1 \$1,278 L2 \$1,337
		Dimensions	D	W	H														
Overall	28 1/2	28 1/2	45 1/4																
Seat	16 5/8	20 3/4	19 3/4																
Arm	33 7/8																		
<table border="1"> <thead> <tr> <th>Upholstery</th> <th colspan="3">Shipping</th> </tr> </thead> <tbody> <tr> <td>COM Ydg</td> <td>3/4</td> <td>Ctn Wt</td> <td>52</td> </tr> <tr> <td>COL Sq Ft</td> <td>14</td> <td>Cu Ft</td> <td>20</td> </tr> </tbody> </table>	Upholstery	Shipping			COM Ydg	3/4	Ctn Wt	52	COL Sq Ft	14	Cu Ft	20							
Upholstery	Shipping																		
COM Ydg	3/4	Ctn Wt	52																
COL Sq Ft	14	Cu Ft	20																

To Order, Specify:

- ① Model Number
- ② Seat Fabric Selection - vendor, pattern and color
- ③ Knit Back Color Selection
- ④ Optional Aluminum Base - add \$84 list
- ⑤ Optional Seat Depth Slide - add \$31 list (synchro tilt models only)
- ⑥ Optional Metal Handle - Black Sandtex (BSX) add \$47 list, Nearly Chrome (NCH) add \$61 list

- ② See a selection of graded in fabric manufacturers and patterns on pages 12-20. Contact Customer Service for additional fabric options.

③ Knit Color Selection:

BA	Barely Blue	RR	Rockin' Red
DA	Dancing Silver	SB	Sandy Beige
JB	Jet Black		

Specifications

- Molded plywood seat.
- Seat has 2" high density polyurethane foam.
- Knit back conforms to shape of back for optimal comfort.
- Swivel tilt models are standard with tilt, lock, pneumatic lift, tension adjustment.
- Synchro models are standard with synchronized independent seat and back recline, lock, pneumatic lift, tensions adjustment, 6 position.
- Polyurethane base, glass reinforced nylon/5-prong/grip ring caster insertion.
- All models standard with 60 mm dual wheel non-hooded black nylon plastic casters.

Tara Order Check List:



SWIVEL

Specify:

- 1. Model Number
- 2. Wood Species - Maple (M)
- 3. Wood Base Finish
- 4. Fabric Selection - vendor, pattern and color
- 5. Base Selection - wood base standard; specify wood finish
 - A. Black Polyurethane Base - no upcharge
 - B. Black Pneumatic Jury Base - add \$164 list
- 6. Optional Plastic Bumper Guard - add \$17 list

Example:

TA6095P (model #)	M (wood species)	AUB (finish) wood base	MOMENTUM (fabric vendor)	VOX (pattern name)	MYSTIC (pattern color)
-----------------------------	----------------------------	-------------------------------------	------------------------------------	------------------------------	----------------------------------

1. Model Number

- Special application instructions (e.g., all stripes will be applied front to back unless specified otherwise)
- Customer and purchase order number

2. Wood Species - Maple (M)

3. Wood Base Finish Options:

ALE Ale	FLX Flax
AUB Auburn	CGR Graphite Coordinate
AUT Autumn	CHL High Line Coordinate
BRL Barley	CKC Khaki Coordinate
CBE Blonde Echo Coordinate	LGC Legacy
BBN Bourbon	MCH Mocha
CBZ Brazilwood Coordinate	NTO Night Owl
BRG Brighton	PRL Praline
BUT Butterscotch	SAF Saffron
CIN Cinnamon	SIE Sienna
CLA Classic	CST Studio Teak Coordinate
CCF Coffee Coordinate	TOF Toffee
CCR Cremello Coordinate	TRF Truffle
EAR Earthy	VEN Venetian
ESP Espresso	CWH Walnut Heights Coordinate

Ship prepaid COM material to:
 JSI
 Attn: COM Dept
 932 Mill Street
 Jasper, IN 47546

Application of fabric:
 Railroaded Up the Roll

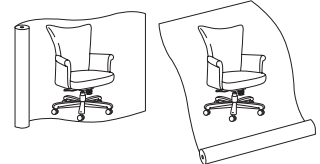

All COM orders will ship at standard lead time from receipt of COM except for orders requiring special custom matched finishes.

4. Fabric Selection - Please supply the following:

- Fabric vendor
- Pattern name
- Pattern color

When specifying contrasting upholstery, indicate clearly which upholstery is to be applied to the seat, back and arms. Use higher grade pricing.

- Indicate direction of fabric - Railroaded or Up the Roll
- Please provide illustration, if available

All COM orders must include the following:

- Vendor's name, pattern name and color
- Sample of the fabric attached to order
- Model numbers of items for fabric application

- 5. Base Selection - wood base standard; specify wood finish**
- A. Black Polyurethane Base - no upcharge
 - B. Black Pneumatic Jury Base - add \$164 list





Pneumatic lift-
 NOT self-centering -
 Standard

- 6. Optional Plastic Bumper Guard - add \$17 list**

For Tara Guest Seating, see page 125.

Description	① Model	Specifications				List Price Per Grade	
Executive Posture 	TA6095P · plain back · standard size · synchro control · adjustable back height · overall height range is 43 ½ - 47 · seat height range is 19 ½ - 23 · arm height range is 26 ½ - 30	Dimensions		D	W	H	COM \$1,838
		Overall	27 ½	30	47	A \$1,874	
		Seat	19 ½	20 ½	23	B \$1,943	
		Arm			30	COL/C \$2,065	
		Upholstery		Shipping		D \$2,221	
		COM Ydg	4	Ctn Wt	55	E \$2,378	
		COL Sq Ft	72	Cu Ft	19	F \$2,543	
						G \$2,777	
						H \$3,027	
						I \$3,418	
				J \$3,888			
				L1 \$2,824			
				L2 \$3,074			

Executive Posture 	TA6095S · single stitch · standard size · synchro control · adjustable back height · overall height range is 43 ½ - 47 · seat height range is 19 ½ - 23 · arm height range is 26 ½ - 30	Dimensions		D	W	H	COM \$1,885
		Overall	27 ½	30	47	A \$1,921	
		Seat	19 ½	20 ½	23	B \$1,990	
		Arm			30	COL/C \$2,112	
		Upholstery		Shipping		D \$2,268	
		COM Ydg	4	Ctn Wt	55	E \$2,425	
		COL Sq Ft	72	Cu Ft	19	F \$2,590	
						G \$2,824	
						H \$3,074	
						I \$3,465	
				J \$3,935			
				L1 \$2,871			
				L2 \$3,121			

Executive Posture 	TA6095B · button stitch · standard size · synchro control · adjustable back height · overall height range is 43 ½ - 47 · seat height range is 19 ½ - 23 · arm height range is 26 ½ - 30	Dimensions		D	W	H	COM \$1,887
		Overall	27 ½	30	47	A \$1,923	
		Seat	19 ½	20 ½	23	B \$1,992	
		Arm			30	COL/C \$2,114	
		Upholstery		Shipping		D \$2,271	
		COM Ydg	4	Ctn Wt	55	E \$2,427	
		COL Sq Ft	72	Cu Ft	19	F \$2,592	
						G \$2,826	
						H \$3,076	
						I \$3,468	
				J \$3,937			
				L1 \$2,873			
				L2 \$3,123			

Executive Swivel 	TA6085P · plain back · standard size · mid-pivot · overall height range is 43 ½ - 47 · seat height range is 19 ½ - 23 · arm height range is 26 ½ - 30	Dimensions		D	W	H	COM \$1,672
		Overall	26 ½	30	47	A \$1,708	
		Seat	19 ½	20 ½	23	B \$1,777	
		Arm			30	COL/C \$1,899	
		Upholstery		Shipping		D \$2,055	
		COM Ydg	4	Ctn Wt	55	E \$2,212	
		COL Sq Ft	72	Cu Ft	19	F \$2,377	
						G \$2,611	
						H \$2,861	
						I \$3,252	
				J \$3,722			
				L1 \$2,658			
				L2 \$2,908			

Description	Model	Specifications				List Price Per Grade	
		Dimensions	D	W	H	COM	
Executive Swivel 	TA6085S • single stitch • standard size • mid-pivot • overall height range is 43 ½ - 47 • seat height range is 19 ½ - 23 • arm height range is 26 ½ - 30	Overall	26 ½	30	47	COM	\$1,718
		Seat	19 ½	20 ½	23	COL/C	\$1,945
		Arm			30	D	\$2,102
		Upholstery		Shipping		E	\$2,258
		COM Ydg	4	Ctn Wt	55	F	\$2,423
		COL Sq Ft	72	Cu Ft	19	G	\$2,657
						H	\$2,907
						I	\$3,299
						J	\$3,768
						L1	\$2,704
				L2	\$2,954		

Description	Model	Specifications				List Price Per Grade	
		Dimensions	D	W	H	COM	
Executive Swivel 	TA6085B • button stitch • standard size • mid-pivot • overall height range is 43 ½ - 47 • seat height range is 19 ½ - 23 • arm height range is 26 ½ - 30	Overall	26 ½	30	47	COM	\$1,720
		Seat	19 ½	20 ½	23	COL/C	\$1,947
		Arm			30	D	\$2,104
		Upholstery		Shipping		E	\$2,260
		COM Ydg	4	Ctn Wt	55	F	\$2,425
		COL Sq Ft	72	Cu Ft	19	G	\$2,659
						H	\$2,909
						I	\$3,301
						J	\$3,770
						L1	\$2,706
				L2	\$2,956		

Description	Model	Specifications				List Price Per Grade	
		Dimensions	D	W	H	COM	
Executive Swivel 	TA6075P • plain back • smaller scale • mid-pivot • overall height range is 43 ½ - 47 • seat height range is 19 ½ - 23 • arm height range is 26 ½ - 30	Overall	26	28	47	COM	\$1,603
		Seat	18 ½	18 ½	23	COL/C	\$1,830
		Arm			30	D	\$1,986
		Upholstery		Shipping		E	\$2,142
		COM Ydg	4	Ctn Wt	55	F	\$2,307
		COL Sq Ft	72	Cu Ft	19	G	\$2,541
						H	\$2,791
						I	\$3,183
						J	\$3,652
						L1	\$2,589
				L2	\$2,839		

To Order, Specify:

- 1 Model Number
- 2 Wood Species - Maple (M)
- 3 Wood Base Finish
- 4 Fabric Selection - vendor, pattern and color
- 5 Base Selection - wood base standard; specify wood finish
 - A. Black Polyurethane Base - no upcharge
 - B. Black Pneumatic Jury Base - add \$164 list
- 6 Optional Plastic Bumper Guard - add \$17 list

3 Wood Base Finish Options:

- | | |
|----------------------------|-------------------------------|
| ALE Ale | FLX Flax |
| AUB Auburn | CGR Graphite Coordinate |
| AUT Autumn | CHL High Line Coordinate |
| BRL Barley | CKC Khaki Coordinate |
| CBE Blonde Echo Coordinate | LGC Legacy |
| BBN Bourbon | MCH Mocha |
| CBZ Brazilwood Coordinate | NTO Night Owl |
| BRG Brighton | PRL Praline |
| BUT Butterscotch | SAF Saffron |
| CIN Cinnamon | SIE Sienna |
| CLA Classic | CST Studio Teak Coordinate |
| CCF Coffee Coordinate | TOF Toffee |
| CCR Cremello Coordinate | TRF Truffle |
| EAR Earthy | VEN Venetian |
| ESP Espresso | CWH Walnut Heights Coordinate |

- 4 See a selection of graded in fabric manufacturers and patterns on pages 12-20. Contact Customer Service for additional fabric options.

Specifications

- Wood species - Maple.
- Seat has synthetic sheet webbing and 4" polyurethane foam.
- Back has synthetic sheet webbing and 1 ¼" polyurethane foam with Dacron® wrap.
- Arms have 1" polyurethane padding with Dacron® wrap.
- Swivel models revolve, have tension control, pneumatic lift, mid-pivot-tilt with a non-locking mechanism and wood cap base with black dual wheel casters.
- Posture models revolve, have back height adjustment, tension control, pneumatic lift, 22° range of travel and multiple position tilt lock.
- Spiral grooved hardwood dowels with corner blocks, glue and screws.

Description	① Model	Specifications				List Price Per Grade		
Executive Swivel 	TA6075S · single stitch · smaller scale · mid-pivot · overall height range is 43 ½ - 47 · seat height range is 19 ½ - 23 · arm height range is 26 ½ - 30	Dimensions		D	W	H	COM \$1,649	
		Overall		26	28	47	A \$1,685	
		Seat		18 ½	18 ½	23	B \$1,754	
		Arm					30	COL/C \$1,876
		Upholstery		Shipping				D \$2,032
		COM Ydg		4	Ctn Wt		55	E \$2,189
		COL Sq Ft		72	Cu Ft		19	F \$2,354
								G \$2,588
								H \$2,838
								I \$3,229
						J \$3,699		
						L1 \$2,635		
						L2 \$2,885		

Executive Swivel 	TA6075B · button stitch · smaller scale · mid-pivot · overall height range is 43 ½ - 47 · seat height range is 19 ½ - 23 · arm height range is 26 ½ - 30	Dimensions		D	W	H	COM \$1,651	
		Overall		26	28	47	A \$1,687	
		Seat		18 ½	18 ½	23	B \$1,756	
		Arm					30	COL/C \$1,878
		Upholstery		Shipping				D \$2,034
		COM Ydg		4	Ctn Wt		55	E \$2,191
		COL Sq Ft		72	Cu Ft		19	F \$2,356
								G \$2,590
								H \$2,840
								I \$3,231
						J \$3,701		
						L1 \$2,637		
						L2 \$2,887		

Management Posture 	TA6090P · plain back · standard size · synchro control · adjustable back height · overall height range is 40 - 44 · seat height range is 19 ½ - 23 · arm height range is 26 ½ - 30	Dimensions		D	W	H	COM \$1,763	
		Overall		27 ½	30	44	A \$1,799	
		Seat		19 ½	20 ½	23	B \$1,868	
		Arm					30	COL/C \$1,990
		Upholstery		Shipping				D \$2,147
		COM Ydg		4	Ctn Wt		50	E \$2,303
		COL Sq Ft		72	Cu Ft		14	F \$2,468
								G \$2,702
								H \$2,952
								I \$3,344
						J \$3,813		
						L1 \$2,749		
						L2 \$2,999		

Management Posture 	TA6090S · single stitch · standard size · synchro control · adjustable back height · overall height range is 40 - 44 · seat height range is 19 ½ - 23 · arm height range is 26 ½ - 30	Dimensions		D	W	H	COM \$1,811	
		Overall		27 ½	30	44	A \$1,846	
		Seat		19 ½	20 ½	23	B \$1,916	
		Arm					30	COL/C \$2,037
		Upholstery		Shipping				D \$2,194
		COM Ydg		4	Ctn Wt		50	E \$2,350
		COL Sq Ft		72	Cu Ft		14	F \$2,515
								G \$2,749
								H \$2,999
								I \$3,391
						J \$3,860		
						L1 \$2,797		
						L2 \$3,047		

Description	Model	Specifications				List Price Per Grade		
Management Posture 	TA6090B • button stitch • standard size • synchro control • adjustable back height • overall height range is 40 - 44 • seat height range is 19 1/2 - 23 • arm height range is 26 1/2 - 30	Dimensions		D	W	H	COM	\$1,813
		Overall		27 1/2	30	44	A	\$1,848
		Seat		19 1/2	20 1/2	23	B	\$1,918
		Arm				30	COL/C	\$2,040
		Upholstery		Shipping				
		COM Ydg		4	Ctn Wt	50	D	\$2,196
		COL Sq Ft		72	Cu Ft	14	E	\$2,352
							F	\$2,517
							G	\$2,751
							H	\$3,001
					I	\$3,393		
					J	\$3,862		
					L1	\$2,799		
					L2	\$3,049		

Description	Model	Specifications				List Price Per Grade		
Management Swivel 	TA6080P • plain back • standard size • mid-pivot • overall height range is 39 1/2 - 43 • seat height range is 19 1/2 - 23 • arm height range is 26 1/2 - 30	Dimensions		D	W	H	COM	\$1,598
		Overall		25 1/2	30	43	A	\$1,633
		Seat		19 1/2	20 1/2	23	B	\$1,703
		Arm				30	COL/C	\$1,824
		Upholstery		Shipping				
		COM Ydg		4	Ctn Wt	50	D	\$1,981
		COL Sq Ft		72	Cu Ft	14	E	\$2,137
							F	\$2,302
							G	\$2,536
							H	\$2,786
					I	\$3,178		
					J	\$3,647		
					L1	\$2,583		
					L2	\$2,833		

Description	Model	Specifications				List Price Per Grade		
Management Swivel 	TA6080S • single stitch • standard size • mid-pivot • overall height range is 39 1/2 - 43 • seat height range is 19 1/2 - 23 • arm height range is 26 1/2 - 30	Dimensions		D	W	H	COM	\$1,644
		Overall		25 1/2	30	43	A	\$1,679
		Seat		19 1/2	20 1/2	23	B	\$1,749
		Arm				30	COL/C	\$1,871
		Upholstery		Shipping				
		COM Ydg		4	Ctn Wt	50	D	\$2,027
		COL Sq Ft		72	Cu Ft	14	E	\$2,183
							F	\$2,348
							G	\$2,582
							H	\$2,832
					I	\$3,224		
					J	\$3,693		
					L1	\$2,630		
					L2	\$2,880		

To Order, Specify:

- 1 Model Number
- 2 Wood Species - Maple (M)
- 3 Wood Base Finish
- 4 Fabric Selection - vendor, pattern and color
- 5 Base Selection - wood base standard; specify wood finish
 - A. Black Polyurethane Base - no upcharge
 - B. Black Pneumatic Jury Base - add \$164 list
- 6 Optional Plastic Bumper Guard - add \$17 list

3 Wood Base Finish Options:



- | | |
|----------------------------|-------------------------------|
| ALE Ale | FLX Flax |
| AUB Auburn | CGR Graphite Coordinate |
| AUT Autumn | CHL High Line Coordinate |
| BRL Barley | CKC Khaki Coordinate |
| CBE Blonde Echo Coordinate | LGC Legacy |
| BBN Bourbon | MCH Mocha |
| CBZ Brazilwood Coordinate | NTO Night Owl |
| BRG Brighton | PRL Praline |
| BUT Butterscotch | SAF Saffron |
| CIN Cinnamon | SIE Sienna |
| CLA Classic | CST Studio Teak Coordinate |
| CCF Coffee Coordinate | TOF Toffee |
| CCR Cremello Coordinate | TRF Truffle |
| EAR Earthy | VEN Venetian |
| ESP Espresso | CWH Walnut Heights Coordinate |

- 4 See a selection of graded in fabric manufacturers and patterns on pages 12-20. Contact Customer Service for additional fabric options.

Specifications

- Wood species - Maple.
- Seat has synthetic sheet webbing and 4" polyurethane foam.
- Back has synthetic sheet webbing and 1 1/4" polyurethane foam with Dacron® wrap.
- Arms have 1" polyurethane padding with Dacron® wrap.
- Swivel models revolve, have tension control, pneumatic lift, mid-pivot-tilt with a non-locking mechanism and wood cap base with black dual wheel casters.
- Posture models revolve, have back height adjustment, tension control, pneumatic lift, 22° range of travel and multiple position tilt lock.
- Spiral grooved hardwood dowels with corner blocks, glue and screws.

SWIVEL

Description	① Model	Specifications				List Price Per Grade	
Management Swivel 	TA6080B · button stitch · standard size · mid-pivot · overall height range is 39½ - 43 · seat height range is 19½ - 23 · arm height range is 26½ - 30	Dimensions		D	W	H	COM \$1,646
		Overall	25 ½	30	43	A \$1,682	
		Seat	19 ½	20 ½	23	B \$1,751	
		Arm			30	COL/C \$1,873	
		Upholstery		Shipping		D \$2,029	
		COM Ydg	4	Ctn Wt	50	E \$2,186	
		COL Sq Ft	72	Cu Ft	14	F \$2,350	
						G \$2,585	
						H \$2,834	
						I \$3,226	
Management Swivel 	TA6070P · plain back · smaller scale · mid-pivot · overall height range is 39½ - 43 · seat height range is 19½ - 23 · arm height range is 26½ - 30	Dimensions		D	W	H	COM \$1,526
		Overall	25	28	43	A \$1,562	
		Seat	18 ½	18 ½	23	B \$1,631	
		Arm			30	COL/C \$1,753	
		Upholstery		Shipping		D \$1,909	
		COM Ydg	4	Ctn Wt	50	E \$2,066	
		COL Sq Ft	72	Cu Ft	14	F \$2,231	
						G \$2,465	
						H \$2,715	
						I \$3,106	
Management Swivel 	TA6070S · single stitch · smaller scale · mid-pivot · overall height range is 39½ - 43 · seat height range is 19½ - 23 · arm height range is 26½ - 30	Dimensions		D	W	H	COM \$1,572
		Overall	25	28	43	A \$1,608	
		Seat	18 ½	18 ½	23	B \$1,677	
		Arm			30	COL/C \$1,799	
		Upholstery		Shipping		D \$1,956	
		COM Ydg	4	Ctn Wt	50	E \$2,112	
		COL Sq Ft	72	Cu Ft	14	F \$2,277	
						G \$2,511	
						H \$2,761	
						I \$3,153	

Description	Model	Specifications				List Price Per Grade	
		Dimensions	D	W	H	COM	
Management Swivel	TA6070B • button stitch • smaller scale • mid-pivot • overall height range is 39 ½ - 43 • seat height range is 19 ½ - 23 • arm height range is 26 ½ - 30	Overall	25	28	43	A	\$1,610
		Seat	18 ½	18 ½	23	B	\$1,679
		Arm	30			COL/C	\$1,801
		Upholstery		Shipping		D	\$1,958
		COM Ydg	4	Ctn Wt	50	E	\$2,114
		COL Sq Ft	72	Cu Ft	14	F	\$2,279
						G	\$2,513
						H	\$2,763
						I	\$3,155
						J	\$3,624
						L1	\$2,560
						L2	\$2,810

SWIVEL

To Order, Specify:

- ① Model Number
- ② Wood Species - Maple (M)
- ③ Wood Base Finish
- ④ Fabric Selection - vendor, pattern and color
- ⑤ Base Selection - wood base standard; specify wood finish
 - A. Black Polyurethane Base - no upcharge
 - B. Black Pneumatic Jury Base - add \$164 list
- ⑥ Optional Plastic Bumper Guard - add \$17 list

③ Wood Base Finish Options:

ALE Ale	FLX Flax
AUB Auburn	CGR Graphite Coordinate
AUT Autumn	CHL High Line Coordinate
BRL Barley	CKC Khaki Coordinate
CBE Blonde Echo Coordinate	LGC Legacy
BBN Bourbon	MCH Mocha
CBZ Brazilwood Coordinate	NTO Night Owl
BRG Brighton	PRL Praline
BUT Butterscotch	SAF Saffron
CIN Cinnamon	SIE Sienna
CLA Classic	CST Studio Teak Coordinate
CCF Coffee Coordinate	TOF Toffee
CCR Cremello Coordinate	TRF Truffle
EAR Earthy	VEN Venetian
ESP Espresso	CWH Walnut Heights Coordinate

- ④ See a selection of graded in fabric manufacturers and patterns on pages 12-20. Contact Customer Service for additional fabric options.

Specifications

- Wood species - Maple.
- Seat has synthetic sheet webbing and 4" polyurethane foam.
- Back has synthetic sheet webbing and 1 ¼" polyurethane foam with Dacron® wrap.
- Arms have 1" polyurethane padding with Dacron® wrap.
- Swivel models revolve, have tension control, pneumatic lift, mid-pivot-tilt with a non-locking mechanism and wood cap base with black dual wheel casters.
- Posture models revolve, have back height adjustment, tension control, pneumatic lift, 22° range of travel and multiple position tilt lock.
- Spiral grooved hardwood dowels with corner blocks, glue and screws.

Tyler Order Check List:



SWIVEL

Specify:

- 1. Model Number
- 2. Fabric Selection - vendor, pattern and color
- 3. Base Selection - black polyurethane base standard
 - A. Aluminum Base - add \$84 list
 - B. Black Pneumatic Jury Base - add \$164 list
- 4. Optional Mid-Pivot Swivel-Tilt Mechanism - add \$108 list
- 5. Optional Base Glides - add \$10 list

Example:

TY8600 | **MOMENTUM** | **VOX** | **MYSTIC**
 (model #) | (fabric vendor) | (pattern name) | (pattern color)

1. Model Number

2. Fabric Selection - Please supply the following:

- Fabric vendor
- Pattern name
- Pattern color

When specifying contrasting upholstery, indicate clearly which upholstery is to be applied to the seat, back and arms. Use higher grade pricing.

- Indicate direction of fabric - Railroaded or Up the Roll
- Please provide illustration, if available

All COM orders must include the following:

- Vendor's name, pattern name and color
- Sample of the fabric attached to order
- Model numbers of items for fabric application
- Special application instructions (e.g., all stripes will be applied front to back unless specified otherwise)
- Customer and purchase order number

Ship prepaid COM material to:
 JSI
 Attn: COM Dept
 932 Mill Street
 Jasper, IN 47546

Application of fabric:
 Railroaded Up the Roll

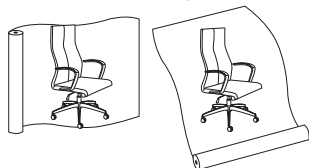

All COM orders will ship at standard lead time from receipt of COM except for orders requiring special custom matched finishes.

3. Base Selections - black polyurethane base standard

- A. Aluminum base - add \$84 list
- B. Black pneumatic jury base - add \$164 list

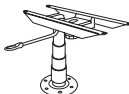

Pneumatic lift- NOT self-centering - Standard

4. Pneumatic Swivel Tilt Control (Standard) -





Optional mid-pivot swivel-tilt mechanism - add \$108 list

5. Optional Base Glides - add \$10 list



Description	1 Model	Specifications			List Price Per Grade	
Management Mid Back 	TY8600 · armless · overall height range is 37 - 42 · seat height range is 17 - 22	Dimensions			COM \$775	
			D	W	H	A \$789
		Overall	26	26	42	B \$815
		Seat	18	19½	22	COL/C \$860
		Arm				D \$919
		Upholstery		Shipping		E \$978
		COM Ydg	1¾ ▲	Ctn Wt	28	F \$1,040
		COL Sq Ft	32 ▲	Cu Ft	14	G \$1,128
						H \$1,222
						I \$1,369
				J \$1,544		
				L1 \$1,145		
				L2 \$1,239		

Management Mid Back 	TY8610T · adjustable T arm · overall height range is 37 - 42 · seat height range is 17 - 22 · arm height range is 24¼ - 32¾	Dimensions			COM \$848	
			D	W	H	A \$861
		Overall	26	26	42	B \$888
		Seat	18	19½	22	COL/C \$933
		Arm			32¾	D \$992
		Upholstery		Shipping		E \$1,050
		COM Ydg	1¾ ▲	Ctn Wt	35	F \$1,112
		COL Sq Ft	32 ▲	Cu Ft	14	G \$1,201
						H \$1,294
						I \$1,441
				J \$1,616		
				L1 \$1,217		
				L2 \$1,312		

Management Mid Back 	TY8610L · fixed height loop arm · overall height range is 37 - 42 · seat height range is 17 - 22 · arm height range is 25 - 30	Dimensions			COM \$848	
			D	W	H	A \$861
		Overall	26	26	42	B \$888
		Seat	18	19½	22	COL/C \$933
		Arm			30	D \$992
		Upholstery		Shipping		E \$1,050
		COM Ydg	1¾ ▲	Ctn Wt	35	F \$1,112
		COL Sq Ft	32 ▲	Cu Ft	14	G \$1,201
						H \$1,294
						I \$1,441
				J \$1,616		
				L1 \$1,217		
				L2 \$1,312		

To Order, Specify:

- 1 Model Number
- 2 Fabric Selection - vendor, pattern and color
- 3 Base Selection - black polyurethane base standard
 - A. Aluminum Base - add \$84 list
 - B. Black Pneumatic Jury Base - add \$164 list
- 4 Optional Mid-Pivot Swivel-Tilt Mechanism (MP) - add \$108 list
- 4 Optional Base Glides (G) - add \$10 list

- 2 See a selection of graded in fabric manufacturers and patterns on pages 12-20. Contact Customer Service for additional fabric options.

Specifications

- One piece solid plywood construction.
- Seat has 2½" polyurethane foam.
- Back has 1½" polyurethane foam and vertical stitch detail.
- All models standard with swivel tilt, lock, pneumatic lift, tension adjustment and a black polyurethane base with dual wheel casters.

When ordering Quickship products, place a "Q" in front of model number.
Example: QGT4901D

NOW!
Need it.
JSI Quickship

SWIVEL

Description	① Model	Specifications	List Price Per Grade												
Executive High Back 	TY8620 · armless · overall height range is 44 - 49 · seat height range is 17 - 22	<table border="1"> <thead> <tr> <th>Dimensions</th> <th>D</th> <th>W</th> <th>H</th> </tr> </thead> <tbody> <tr> <td>Overall</td> <td>26</td> <td>26</td> <td>49</td> </tr> <tr> <td>Seat</td> <td>18</td> <td>19½</td> <td>22</td> </tr> </tbody> </table>	Dimensions	D	W	H	Overall	26	26	49	Seat	18	19½	22	COM \$803 A \$818 B \$849 COL/C \$902 D \$971 E \$1,039 F \$1,111 G \$1,213 H \$1,323 I \$1,495 J \$1,699 L1 \$1,234 L2 \$1,343
		Dimensions	D	W	H										
Overall	26	26	49												
Seat	18	19½	22												
<table border="1"> <thead> <tr> <th>Upholstery</th> <th colspan="3">Shipping</th> </tr> </thead> <tbody> <tr> <td>COM Ydg</td> <td>2 ▲</td> <td>Ctn Wt</td> <td>36</td> </tr> <tr> <td>COL Sq Ft</td> <td>36 ▲</td> <td>Cu Ft</td> <td>14</td> </tr> </tbody> </table>	Upholstery	Shipping			COM Ydg	2 ▲	Ctn Wt	36	COL Sq Ft	36 ▲	Cu Ft	14			
Upholstery	Shipping														
COM Ydg	2 ▲	Ctn Wt	36												
COL Sq Ft	36 ▲	Cu Ft	14												

Executive High Back 	TY8630T · adjustable T-arm · overall height range is 44 - 49 · seat height range is 17 - 22 · arm height range is 24¼ - 32¾	<table border="1"> <thead> <tr> <th>Dimensions</th> <th>D</th> <th>W</th> <th>H</th> </tr> </thead> <tbody> <tr> <td>Overall</td> <td>26</td> <td>26</td> <td>49</td> </tr> <tr> <td>Seat</td> <td>18</td> <td>19½</td> <td>22</td> </tr> <tr> <td>Arm</td> <td></td> <td></td> <td>32¾</td> </tr> </tbody> </table>	Dimensions	D	W	H	Overall	26	26	49	Seat	18	19½	22	Arm			32¾	COM \$873 A \$889 B \$919 COL/C \$973 D \$1,041 E \$1,109 F \$1,182 G \$1,284 H \$1,394 I \$1,565 J \$1,770 L1 \$1,305 L2 \$1,414
		Dimensions	D	W	H														
Overall	26	26	49																
Seat	18	19½	22																
Arm			32¾																
<table border="1"> <thead> <tr> <th>Upholstery</th> <th colspan="3">Shipping</th> </tr> </thead> <tbody> <tr> <td>COM Ydg</td> <td>2 ▲</td> <td>Ctn Wt</td> <td>43</td> </tr> <tr> <td>COL Sq Ft</td> <td>36 ▲</td> <td>Cu Ft</td> <td>14</td> </tr> </tbody> </table>	Upholstery	Shipping			COM Ydg	2 ▲	Ctn Wt	43	COL Sq Ft	36 ▲	Cu Ft	14							
Upholstery	Shipping																		
COM Ydg	2 ▲	Ctn Wt	43																
COL Sq Ft	36 ▲	Cu Ft	14																

Executive High Back 	TY8630L · fixed height loop arm · overall height range is 44 - 49 · seat height range is 17 - 22 · arm height range is 25 - 30	<table border="1"> <thead> <tr> <th>Dimensions</th> <th>D</th> <th>W</th> <th>H</th> </tr> </thead> <tbody> <tr> <td>Overall</td> <td>26</td> <td>26</td> <td>49</td> </tr> <tr> <td>Seat</td> <td>18</td> <td>19½</td> <td>22</td> </tr> <tr> <td>Arm</td> <td></td> <td></td> <td>30</td> </tr> </tbody> </table>	Dimensions	D	W	H	Overall	26	26	49	Seat	18	19½	22	Arm			30	COM \$873 A \$889 B \$919 COL/C \$973 D \$1,041 E \$1,109 F \$1,182 G \$1,284 H \$1,394 I \$1,565 J \$1,770 L1 \$1,305 L2 \$1,414
		Dimensions	D	W	H														
Overall	26	26	49																
Seat	18	19½	22																
Arm			30																
<table border="1"> <thead> <tr> <th>Upholstery</th> <th colspan="3">Shipping</th> </tr> </thead> <tbody> <tr> <td>COM Ydg</td> <td>2 ▲</td> <td>Ctn Wt</td> <td>43</td> </tr> <tr> <td>COL Sq Ft</td> <td>36 ▲</td> <td>Cu Ft</td> <td>14</td> </tr> </tbody> </table>	Upholstery	Shipping			COM Ydg	2 ▲	Ctn Wt	43	COL Sq Ft	36 ▲	Cu Ft	14							
Upholstery	Shipping																		
COM Ydg	2 ▲	Ctn Wt	43																
COL Sq Ft	36 ▲	Cu Ft	14																

To Order, Specify:

- ① Model Number
- ② Fabric Selection - vendor, pattern and color
- ③ Base Selection - black polyurethane base standard
 - A. Aluminum Base - add \$84 list
 - B. Black Pneumatic Jury Base - add \$164 list
- ④ Optional Mid-Pivot Swivel-Tilt Mechanism (MP) - add \$108 list
- ④ Optional Base Glides (G) - add \$10 list

- ② See a selection of graded in fabric manufacturers and patterns on pages 12-20. Contact Customer Service for additional fabric options.

Specifications

- One piece solid plywood construction.
- Seat has 2½" polyurethane foam.
- Back has 1½" polyurethane foam and vertical stitch detail.
- All models standard with swivel tilt, lock, pneumatic lift, tension adjustment and a black polyurethane base with dual wheel casters.

When ordering Quickship products, place a "Q" in front of model number.
 Example: QGT4901D



Waltham Order Check List:



SWIVEL

Specify:

- 1. Model Number
- 2. Wood Species - Maple (M)
- 3. Wood Finish
- 4. Fabric Selection - vendor, pattern and color
- 5. Optional Knee Tilt/Gas Mechanism - add \$180 list
- 6. Optional Conference Self-Return Swivel Mechanism - add \$112 list
- 7. Optional Antique Brass Hood over Black Ball Caster - add \$36 list

Example:

WA4013 (model #)	M (wood species)	AUB (finish)	MOMENTUM (fabric vendor)	VOX (pattern name)	MYSTIC (pattern color)
----------------------------	----------------------------	------------------------	------------------------------------	------------------------------	----------------------------------

1. Model Number

2. Wood Species - Maple (M)

3. Wood Finish Options:

ALE Ale	FLX Flax
AUB Auburn	CGR Graphite Coordinate
AUT Autumn	CHL High Line Coordinate
BRL Barley	CKC Khaki Coordinate
CBE Blonde Echo Coordinate	LGC Legacy
BBN Bourbon	MCH Mocha
CBZ Brazilwood Coordinate	NTO Night Owl
BRG Brighton	PRL Praline
BUT Butterscotch	SAF Saffron
CIN Cinnamon	SIE Sienna
CLA Classic	CST Studio Teak Coordinate
CCF Coffee Coordinate	TOF Toffee
CCR Cremello Coordinate	TRF Truffle
EAR Earthy	VEN Venetian
ESP Espresso	CWH Walnut Heights Coordinate

4. Fabric Selection - Please supply the following:

- Vendor name
- Pattern name
- Pattern color

When specifying contrasting upholstery, indicate clearly which upholstery is to be applied to the seat, back and arms. Use higher grade pricing.

- Indicate direction of fabric - Railroaded or Up the Roll
- Please provide illustration, if available

All COM orders must include the following:

- Vendor's name, pattern name and color
- Sample of the fabric attached to order
- Model numbers of items for fabric application
- Special application instructions (e.g., all stripes will be applied front to back unless specified otherwise)
- Customer and purchase order number

Ship prepaid COM material to:
 JSI
 Attn: COM Dept
 932 Mill Street
 Jasper, IN 47546

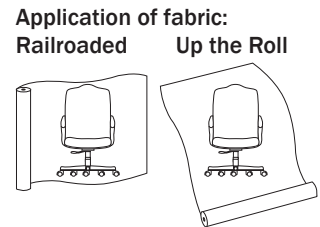

All COM orders will ship at standard lead time from receipt of COM except for orders requiring special custom matched finishes.

5. Optional Knee Tilt/Gas Mechanism - add \$180 list

6. Optional Conference Self-Return Swivel Mechanism - add \$112 list

7. Optional Antique Brass Hood over Black Ball Caster - add \$36 list

For Waltham Guest Seating, see page 129.

SWIVEL

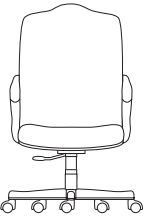
Description	① Model	Specifications				List Price Per Grade	
Executive High Back 	WA4013 · upholstered arm cap, back and seat · open wood arm · seat height range is 17-21▲ · arm height range is 26½-29½▲	Dimensions		D	W	H	COM \$2,309
		Overall	28	24½	45¾▲		A \$2,339
		Seat	18¾	21¾	21		B \$2,394
		Arm			29½		COL/C \$2,493
		Upholstery		Shipping			D \$2,620
		COM Ydg	3¼	Ctn Wt	59		E \$2,747
		COL Sq Ft	59	Cu Ft	21		F \$2,882
							G \$3,073
							H \$3,275
							I \$3,594
							J \$3,975
							L1 \$3,111
							L2 \$3,313

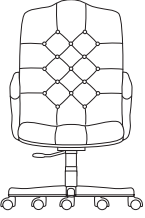
Executive High Back 	WA4018 · upholstered arm cap, back and seat · tufted · open wood arm · seat height range is 17-21▲ · arm height range is 26½-29½▲	Dimensions		D	W	H	COM \$2,702
		Overall	28	24½	45¾▲		A \$2,732
		Seat	18¾	21¾	21		B \$2,787
		Arm			29½		COL/C \$2,886
		Upholstery		Shipping			D \$3,013
		COM Ydg	3¼	Ctn Wt	60		E \$3,140
		COL Sq Ft	59	Cu Ft	21		F \$3,274
							G \$3,465
							H \$3,668
							I \$3,986
							J \$4,367
							L1 \$3,503
							L2 \$3,706

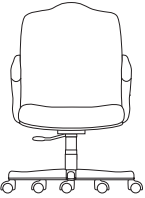
Management Mid Back 	WA4023 · upholstered arm cap, back and seat · open wood arm · seat height range is 17-21▲ · arm height range is 26½-29½▲	Dimensions		D	W	H	COM \$2,136
		Overall	27½	24½	41▲		A \$2,162
		Seat	18¾	21¾	21		B \$2,215
		Arm			29½		COL/C \$2,306
		Upholstery		Shipping			D \$2,424
		COM Ydg	3	Ctn Wt	56		E \$2,540
		COL Sq Ft	54	Cu Ft	19		F \$2,664
							G \$2,841
							H \$3,028
							I \$3,322
							J \$3,673
							L1 \$2,875
							L2 \$3,063

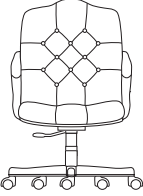
Description	Model	Specifications				List Price Per Grade	
		Dimensions	D	W	H	COM	
Management Mid Back 	WA4028 · upholstered arm cap, back and seat · tufted · open wood arm · seat height range is 17-21 · arm height range is 26 ½ - 29 ½	Overall	27 ½	24 ½	41 [▲]	COM	\$2,528
		Seat	18 ¾	21 ¾	21	A	\$2,554
		Arm			29 ½	B	\$2,607
		Upholstery		Shipping		COL/C	\$2,698
		COM Ydg	3	Ctn Wt	60	D	\$2,816
		COL Sq Ft	54	Cu Ft	19	E	\$2,932
						F	\$3,056
						G	\$3,232
						H	\$3,419
						I	\$3,713
						J	\$4,065
						L1	\$3,267
						L2	\$3,455

SWIVEL

To Order, Specify:

- 1 Model Number
- 2 Wood Species - Maple (M)
- 3 Wood Finish
- 4 Fabric Selection - vendor, pattern and color
- 5 Optional Knee Tilt/Gas Mechanism - add \$180 list
- 6 Optional Conference Self-Return Swivel Mechanism - add \$112 list
- 7 Optional Antique Brass Hood over Black Ball Caster - add \$36 list

3 Wood Finish Options:

ALE	Ale	FLX	Flax
AUB	Auburn	CGR	Graphite Coordinate
AUT	Autumn	CHL	High Line Coordinate
BRL	Barley	CKC	Khaki Coordinate
CBE	Blonde Echo Coordinate	LGC	Legacy
BBN	Bourbon	MCH	Mocha
CBZ	Brazilwood Coordinate	NTO	Night Owl
BRG	Brighton	PRL	Praline
BUT	Butterscotch	SAF	Saffron
CIN	Cinnamon	SIE	Sienna
CLA	Classic	CST	Studio Teak Coordinate
CCF	Coffee Coordinate	TOF	Toffee
CCR	Cremello Coordinate	TRF	Truffle
EAR	Earthy	VEN	Venetian
ESP	Espresso	CWH	Walnut Heights Coordinate

- 4 See a selection of graded in fabric manufacturers and patterns on pages 12-20. Contact Customer Service for additional fabric options.

Specifications

- Wood species - Maple.
- One piece solid plywood construction.
- Seat is high resiliency multi-density polyurethane foam.
- Back interior is multi-density polyurethane foam with foam lumbar support.
- Adjustment is mid-pivot, mid-knee tilt with gas height adjustment.
- Wood arm has biscuit reinforcement.
- Arm cap is rigid urethane with neoprene foam.
- C316, wood base cap.
- C10, hooded black double wheel caster.
- Caster is hard tread.

Notes

SMVEL

Guest Seating Overview



Accent 78



Cabaret **NOW!** 80



Collective 82



Gallery 84



Gatsby **NOW!** 86



Harbor 96



Kendall **NOW!** 98



Laurel **NOW!** 101



Madison **NOW!** 107



Portrait 113



Profile **NOW!** 115



Rio 117



Solara 119



Sosa 121



Sultan 123



Tara 125



Totem 127



Waltham 129

Guest Seating Specifications (Unique features for a model will be cited on the price pages for that model).

Rights and Lefts

The handedness of the chair is determined by seated position.

Exterior Wood Materials

All materials used in our guest seating are kiln dried lumber from suppliers practicing forest sustainability. Any defects in the wood that are removed during our process are utilized in other areas of production.

Some of our guest seating may contain steam bent lumber from our proprietary process. Steam bending allows us to provide additional strength, increase our lumber yield, and provide seamless beauty in the chair.

Interior Frame Materials

A combination of materials are used to create interior frame components, including solid lumber, plywood, metal plates, and high grade upholstery board.

Construction

Tenon style joinery is used in most frame construction for our seating products; however, dowel pin joinery may also be used. Engineering will determine, based on design which joinery is best for the frame design of each particular design. Critical joints are reinforced with mechanical fastening.

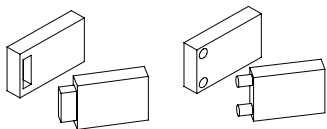

Tenon

Dowels

Upholstery Details

Seat webbing is either applied to a seat pan or frame depending upon the style. High resilience foam rides on the sheet webbing suspension. Several of our guest seating models utilize solid plywood for the seat platform and this is done to meet a needed criteria.

High density foam is used on back, arms and deck. Dual density foam is also used to provide for additional comfort.

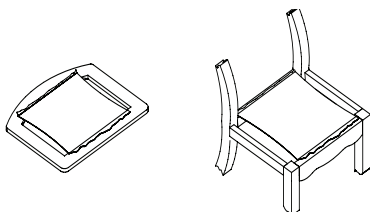

Finish

Each of the wood components that goes into a chair will have unique characteristic; the process of shaping and machining these parts may expose additional natural characteristics. To accentuate the beauty of the wood, special care is taken in selecting the frame component for each finish color.

Finish colors may vary slightly when comparing solid wood product finish to our casegoods veneer product finish. Exceptional care is taken to assure a uniform color on solid wood products.

Former finish names are listed in parentheses for reference.

Seating Finishes

ALE	Ale (Natural Maple)	FLX	Flax
AUB	Auburn (Windsor Mahogany)	LGC	Legacy (Legacy Cherry)
AUT	Autumn (Autumn Cherry)	MCH	Mocha
BRL	Barley	NTO	Night Owl (Vintage Walnut)
BBN	Bourbon (Natural Cherry)	PRL	Praline (Vintage Cherry)
BRG	Brighton (Brighton Cherry)	SAF	Saffron (Medium Cherry)
BUT	Butterscotch	SIE	Sienna
CIN	Cinnamon	TOF	Toffee
CLA	Classic (Classic Cherry)	TRF	Truffle
EAR	Earthy	VEN	Venetian (Dark Mahogany)
ESP	Espresso		

Color Coordinates

Color Coordinate Finishes are intended to coordinate with select laminate and double cut veneer casegood finishes. They represent an average color and do not match the grain pattern of the coordinating laminate or double cut veneer.

CBE	Blonde Echo Coordinate	CHL	High Line Coordinate
CBZ	Brazilwood Coordinate	CKC	Khaki Coordinate
CCF	Coffee Coordinate	CST	Studio Teak Coordinate
CCR	Cremello Coordinate	CWH	Walnut Heights Coordinate
CGR	Graphite Coordinate		

Not all finishes are available in every seating series. Reference the Order Check List at the beginning of each series.

Protective Top Coat

We are proud that our finish is GreenGuard certified. To reduce hazardous formaldehyde emission we use our proprietary specially designed top coat, DuraTex™. Our DuraTex™ top coat offers exceptional hardness along with abrasion and impact resistance, but has been formulated to eliminate the hazardous and harmful gases that are normally associated with wood finish.

DuraTex™ Features

Safety - Significantly reduces hazardous formaldehyde emissions which help improve the quality of the of the indoor air we breathe.

Quality - Developed to be tough and durable with special attention to appearance. The DuraTex™ finish provides a safe solution and still preserves the natural beauty of wood.

Durability - Designed to meet a wide range of demanding performance and environmental standards to withstand even the highest wear and tear.

Guest Seating Specifications (Unique features for a model will be cited on the price pages for that model)

Upholstery Cover Application

Unless a customer specifies the fabric to be run “railroad”, the fabric will be “cut up the roll”. Additional seaming may be needed, pending fabric width and textile repeat match. Contact Customer Service with questions.

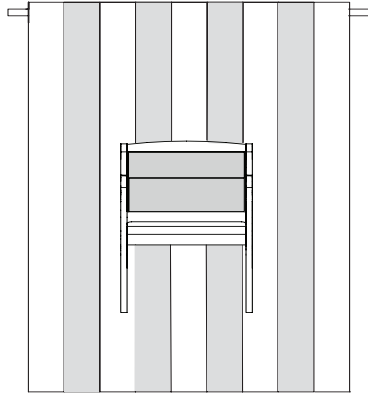

Care of Upholstery Surfaces

Cleanability will vary based on the fabric type. For best results, a professional service is recommended. Dirt and crumbs may be gently brushed or vacuumed off. Spills should be wiped up immediately with a cloth. Vinyl textiles can be cleaned with warm soapy water and wiped down with a warm damp cloth. For more details on any JSI carded fabric and vinyl, please visit our website at jsifurniture.com or consult the back of the appropriate swatch card for cleaning codes and any specific instructions. For COM materials, consult with the individual textile manufacturer for cleaning codes and any specific instructions pertaining to your particular fabric.

Care of Wood Edges and Veneer Surfaces

Clean all surfaces frequently with water dampened soft cloth, moving the cloth with the grain direction. Immediately remove any liquids that come in contact with wood surfaces, with a blotting action to absorb liquid. Buff dry. Lift objects to move them, never pull them across the finished surface. Avoid exposure of furniture to extremes of heat, cold, and wide variance of humidity. Avoid exposure of furniture to strong sunlight. Avoid exposure of furniture to harsh solvents such as nail polish remover, acetates, etc., as it will cause finish deterioration.

Wipe smooth powder coat finishes and textured metals with a damp cloth. For stubborn stains and grease marks, use soap and water. Lightly brush textured metals with a soft, dry brush to remove dirt will cause finish deterioration.

Accent Order Check List:



Specify:

- 1. Model Number
- 2. Wood Species - Beech (B)
- 3. Wood Finish
- 4. Fabric Selection - vendor, pattern and color
- 5. Optional Rubber Cushion Nylon Glides - no upcharge

Example:

AC6381C | B | AUB | MOMENTUM | VOX | MYSTIC
 (model #) | (wood species) | (finish) | (fabric vendor) | (pattern name) | (pattern color)

1. Model Number

2. Wood Species - Beech (B)

3. Wood Finish Options:

ALE Ale	FLX Flax
AUB Auburn	CGR Graphite Coordinate
AUT Autumn	CHL High Line Coordinate
BRL Barley	CKC Khaki Coordinate
CBE Blonde Echo Coordinate	LGC Legacy
BBN Bourbon	MCH Mocha
CBZ Brazilwood Coordinate	NTO Night Owl
BRG Brighton	PRL Praline
BUT Butterscotch	SAF Saffron
CIN Cinnamon	SIE Sienna
CLA Classic	CST Studio Teak Coordinate
CCF Coffee Coordinate	TOF Toffee
CCR Cremello Coordinate	TRF Truffle
EAR Earthy	VEN Venetian
ESP Espresso	CWH Walnut Heights Coordinate

4. Fabric Selection - Please supply the following:

- Fabric vendor
- Pattern name
- Pattern color

When specifying contrasting upholstery, indicate clearly which upholstery is to be applied to the seat, back and arms. Use higher grade pricing.

- Indicate direction of fabric - Railroaded or Up the Roll
- Please provide illustration, if available

All COM orders must include the following:

- Vendor's name, pattern name and color
- Sample of the fabric attached to order
- Model numbers of items for fabric application
- Special application instructions (e.g., all stripes will be applied front to back unless specified otherwise)
- Customer and purchase order number

Ship prepaid COM material to:
 JSI
 Attn: COM Dept
 932 Mill Street
 Jasper, IN 47546

Application of fabric:
 Railroaded Up the Roll

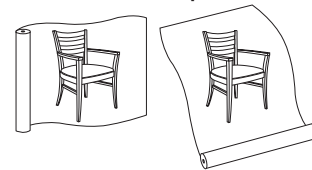

All COM orders will ship at standard lead time from receipt of COM except for orders requiring special custom matched finishes.

5. Optional Rubber Cushion Nylon Glides - no upcharge

GUEST

Description	Model	Specifications				List Price Per Grade	
		Dimensions	D	W	H	COM	
Guest Chair 	AC6381C · upholstered seat · wood back	Overall	22 ½	23	33 ½	COM	\$716
		Seat	18 ¾	19 ½	18 ½	COL/C	\$759
		Arm			25 ¼	D	\$788
		Upholstery		Shipping		E	\$817
		COM Ydg	¾	Ctn Wt	26	F	\$848
		COL Sq Ft	14	Cu Ft	12	G	\$892
						H	\$939
						I	\$1,013
						J	\$1,100
						L1	\$900
						L2	\$948

Description	Model	Specifications				List Price Per Grade	
		Dimensions	D	W	H	COM	
Guest Chair 	AC6381D · upholstered seat and back	Overall	22 ½	23	33 ½	COM	\$793
		Seat	18 ¾	19 ½	18 ½	COL/C	\$850
		Arm			25 ¼	D	\$890
		Upholstery		Shipping		E	\$929
		COM Ydg	1	Ctn Wt	26	F	\$970
		COL Sq Ft	18	Cu Ft	12	G	\$1,028
						H	\$1,090
						I	\$1,189
						J	\$1,306
						L1	\$1,040
						L2	\$1,103

GUEST

To Order, Specify:

- 1 Model Number
- 2 Wood Species - Beech (B)
- 3 Wood Finish
- 4 Fabric Selection - vendor, pattern and color
- 5 Optional Rubber Cushion Nylon Glides - no upcharge

3 Wood Finish Options:

ALE Ale	FLX Flax
AUB Auburn	CGR Graphite Coordinate
AUT Autumn	CHL High Line Coordinate
BRL Barley	CKC Khaki Coordinate
CBE Blonde Echo Coordinate	LGC Legacy
BBN Bourbon	MCH Mocha
CBZ Brazilwood Coordinate	NTO Night Owl
BRG Brighton	PRL Praline
BUT Butterscotch	SAF Saffron
CIN Cinnamon	SIE Sienna
CLA Classic	CST Studio Teak Coordinate
CCF Coffee Coordinate	TOF Toffee
CCR Cremello Coordinate	TRF Truffle
EAR Earthy	VEN Venetian
ESP Espresso	CWH Walnut Heights Coordinate

Specifications

- Wood species - Beech.
- Seat has 1 ½" polyurethane foam.
- Back has ½" polyurethane foam.
- Mortise and tenon construction with corner blocks, glue and screws.
- Standard with rubber cushion metal glides.

- 4 See a selection of graded in fabric manufacturers and patterns on pages 12-20. Contact Customer Service for additional fabric options.

Cabaret Order Check List:



Specify:

- 1. Model Number
- 2. Wood Species - Maple (M)
- 3. Wood Leg Finish
- 4. Fabric Selection - vendor, pattern and color
- 5. Optional Rubber Cushion Nylon Glides - no upcharge

Example:

CR1271 (model #)	M (wood species)	AUB (finish) wood legs	MOMENTUM (fabric vendor)	VOX (pattern name)	MYSTIC (pattern color)
----------------------------	----------------------------	-------------------------------------	------------------------------------	------------------------------	----------------------------------

1. Model Number

2. Wood Species - Maple (M)

3. Wood Leg Finish Options:

ALE Ale	FLX Flax
AUB Auburn	CGR Graphite Coordinate
AUT Autumn	CHL High Line Coordinate
BRL Barley	CKC Khaki Coordinate
CBE Blonde Echo Coordinate	LGC Legacy
BBN Bourbon	MCH Mocha
CBZ Brazilwood Coordinate	NTO Night Owl
BRG Brighton	PRL Praline
BUT Butterscotch	SAF Saffron
CIN Cinnamon	SIE Sienna
CLA Classic	CST Studio Teak Coordinate
CCF Coffee Coordinate	TOF Toffee
CCR Cremello Coordinate	TRF Truffle
EAR Earthy	VEN Venetian
ESP Espresso	CWH Walnut Heights Coordinate

4. Fabric Selection - Please supply the following:

- Fabric vendor
- Pattern name
- Pattern color

When specifying contrasting upholstery, indicate clearly which upholstery is to be applied to the seat, back and arms. Use higher grade pricing.

- Indicate direction of fabric - Railroaded or Up the Roll
- Please provide illustration, if available

All COM orders must include the following:

- Vendor's name, pattern name and color
- Sample of the fabric attached to order
- Model numbers of items for fabric application
- Special application instructions (e.g., all stripes will be applied front to back unless specified otherwise)
- Customer and purchase order number

Ship prepaid COM material to:
 JSI
 Attn: COM Dept
 932 Mill Street
 Jasper, IN 47546

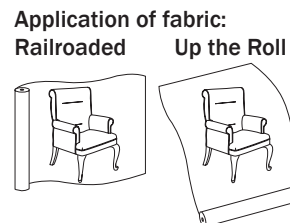

All COM orders will ship at standard lead time from receipt of COM except for orders requiring special custom matched finishes.

5. Optional Rubber Cushion Nylon Glides - no upcharge

For Cabaret Swivel Seating, see page 37.

Description	Model	Specifications				List Price Per Grade	
		Dimensions	D	W	H	COM	
Guest Chair	CR1271	Overall	31	29	38	A	\$1,233
		Seat	19½	19	19½	B	\$1,269
		Arm			27	C	\$1,338
		Upholstery		Shipping		COL/C	\$1,460
		COM Ydg	4	Ctn Wt	40	D	\$1,616
		COL Sq Ft	72	Cu Ft	14	E	\$1,773
						F	\$1,938
						G	\$2,172
						H	\$2,422
						I	\$2,813
						J	\$3,283
					L1	\$2,219	
					L2	\$2,469	

GUEST

To Order, Specify:

- 1 Model Number
- 2 Wood Species - Maple (M)
- 3 Wood Leg Finish
- 4 Fabric Selection - vendor, pattern and color
- 5 Optional Rubber Cushion Nylon Glides - no upcharge

3 Wood Leg Finish Options:

ALE Ale	FLX Flax
AUB Auburn	CGR Graphite Coordinate
AUT Autumn	CHL High Line Coordinate
BRL Barley	CKC Khaki Coordinate
CBE Blonde Echo Coordinate	LGC Legacy
BBN Bourbon	MCH Mocha
CBZ Brazilwood Coordinate	NTO Night Owl
BRG Brighton	PRL Praline
BUT Butterscotch	SAF Saffron
CIN Cinnamon	SIE Sienna
CLA Classic	CST Studio Teak Coordinate
CCF Coffee Coordinate	TOF Toffee
CCR Cremello Coordinate	TRF Truffle
EAR Earthy	VEN Venetian
ESP Espresso	CWH Walnut Heights Coordinate

Specifications

- Wood species - Maple.
- Seat has synthetic sheet webbing and 4" polyurethane foam.
- Back has polypropylene webbing and 2" polyurethane foam and integrated lumbar support.
- Spiral grooved hardwood dowels with corner blocks, glue and screws.
- Standard with rubber cushion metal glides.

When ordering Quickship products, place a "Q" in front of model number.
Example: QGT4901D



- 4 See a selection of graded in fabric manufacturers and patterns on pages 12-20. Contact Customer Service for additional fabric options.

Collective Order Check List:



Specify:

- 1. Model Number
- 2. Wood Species - Maple (M)
- 3. Wood Finish
- 4. Fabric Selection - vendor, pattern and color

Example:

CM4517 (model #)	M (wood species)	AUB (finish)	MOMENTUM (fabric vendor)	VOX (pattern name)	MYSTIC (pattern color)
----------------------------	----------------------------	------------------------	------------------------------------	------------------------------	----------------------------------

1. Model Number

2. Wood Species - Maple (M)

3. Wood Finish Options:

ALE Ale	FLX Flax
AUB Auburn	CGR Graphite Coordinate
AUT Autumn	CHL High Line Coordinate
BRL Barley	CKC Khaki Coordinate
CBE Blonde Echo Coordinate	LGC Legacy
BBN Bourbon	MCH Mocha
CBZ Brazilwood Coordinate	NTO Night Owl
BRG Brighton	PRL Praline
BUT Butterscotch	SAF Saffron
CIN Cinnamon	SIE Sienna
CLA Classic	CST Studio Teak Coordinate
CCF Coffee Coordinate	TOF Toffee
CCR Cremello Coordinate	TRF Truffle
EAR Earthy	VEN Venetian
ESP Espresso	CWH Walnut Heights Coordinate

4. Fabric Selection - Please supply the following:

- Fabric vendor
- Pattern name
- Pattern color

When specifying contrasting upholstery, indicate clearly which upholstery is to be applied to the seat and base or back and seat. Use higher grade pricing.

- Indicate direction of fabric - Railroaded or Up the Roll
- Please provide illustration, if available

All COM orders must include the following:

- Vendor's name, pattern name and color
- Sample of the fabric attached to order
- Model numbers of items for fabric application
- Special application instructions (e.g., all stripes will be applied front to back unless specified otherwise)
- Customer and purchase order number

Ship prepaid COM material to:
 JSI
 Attn: COM Dept
 932 Mill Street
 Jasper, IN 47546

Application of fabric:
 Railroaded Up the Roll

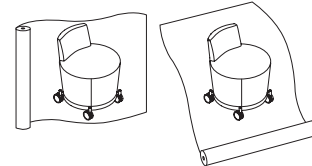

All COM orders will ship at standard lead time from receipt of COM except for orders requiring special custom matched finishes.

Description	Model	Specifications				List Price Per Grade	
		Dimensions	D	W	H	COM	
Mini Mobile Stool 	CM4517 · upholstered seat · four casters	Overall	18 3/8	18 3/8	20 1/2	COM	\$1,004
		Upholstery COM Ydg 1 1/4		Shipping Ctn Wt 31		COL/C	\$1,076
		COL Sq Ft	25	Cu Ft	5	D	\$1,124
						E	\$1,173
						F	\$1,225
						G	\$1,298
						H	\$1,376
						I	\$1,499
						J	\$1,645
						L1	\$1,352
						L2	\$1,440

Description	Model	Specifications				List Price Per Grade	
		Dimensions	D	W	H	COM	
Mini Mobile Stool with Backrest 	CM4519 · upholstered seat and backrest · backrest is 8" high · five casters	Overall	22	21	25	COM	\$1,437
		Upholstery COM Ydg 2		Shipping Ctn Wt 35		COL/C	\$1,550
		COL Sq Ft	40	Cu Ft	8	D	\$1,629
						E	\$1,707
						F	\$1,790
						G	\$1,906
						H	\$2,031
						I	\$2,228
						J	\$2,462
						L1	\$1,992
						L2	\$2,133

GUEST

To Order, Specify:

- 1 Model Number
- 2 Wood Species - Maple (M)
- 3 Wood Finish
- 4 Fabric Selection - vendor, pattern and color

3 Wood Finish Options:

ALE Ale	FLX Flax
AUB Auburn	CGR Graphite Coordinate
AUT Autumn	CHL High Line Coordinate
BRL Barley	CKC Khaki Coordinate
CBE Blonde Echo Coordinate	LGC Legacy
BBN Bourbon	MCH Mocha
CBZ Brazilwood Coordinate	NTO Night Owl
BRG Brighton	PRL Praline
BUT Butterscotch	SAF Saffron
CIN Cinnamon	SIE Sienna
CLA Classic	CST Studio Teak Coordinate
CCF Coffee Coordinate	TOF Toffee
CCR Cremello Coordinate	TRF Truffle
EAR Earthy	VEN Venetian
ESP Espresso	CWH Walnut Heights Coordinate

Specifications

- Exposed wood platform species - Maple.
- Arctic Silver powder coated legs with non-locking casters.
- Frame interior is upholstery grade plywood with hardwood cross members.
- Seat interior is high resilient foam with super soft wrap.

- 4 See a selection of graded in fabric manufacturers and patterns on pages 12-20. Contact Customer Service for additional fabric options.

Gallery Order Check List:



Specify:

- 1. Model Number
- 2. Wood Species - Maple (M)
- 3. Wood Finish
- 4. Fabric Selection - vendor, pattern and color
- 5. Optional Casters - add \$92 list; specify color
- 6. Optional Rubber Cushion Nylon Glides - no upcharge

Example:

GL6481P | M | AUB | MOMENTUM | VOX | MYSTIC
 (model #) | (wood species) | (finish) | (fabric vendor) | (pattern name) | (pattern color)

1. Model Number

2. Wood Species - Maple (M)

3. Wood Finish Options:

ALE	Ale	FLX	Flax
AUB	Auburn	CGR	Graphite Coordinate
AUT	Autumn	CHL	High Line Coordinate
BRL	Barley	CKC	Khaki Coordinate
CBE	Blonde Echo Coordinate	LGC	Legacy
BBN	Bourbon	MCH	Mocha
CBZ	Brazilwood Coordinate	NTO	Night Owl
BRG	Brighton	PRL	Praline
BUT	Butterscotch	SAF	Saffron
CIN	Cinnamon	SIE	Sienna
CLA	Classic	CST	Studio Teak Coordinate
CCF	Coffee Coordinate	TOF	Toffee
CCR	Cremello Coordinate	TRF	Truffle
EAR	Earthy	VEN	Venetian
ESP	Espresso	CWH	Walnut Heights Coordinate

4. Fabric Selection - Please supply the following:

- Fabric vendor
- Pattern name
- Pattern color

When specifying contrasting upholstery, indicate clearly which upholstery is to be applied to the seat, back and arms. Use higher grade pricing.

- Indicate direction of fabric - Railroaded or Up the Roll
- Please provide illustration, if available

All COM orders must include the following:

- Vendor's name, pattern name and color
- Sample of the fabric attached to order
- Model numbers of items for fabric application

- Special application instructions (e.g., all stripes will be applied front to back unless specified otherwise)
- Customer and purchase order number

Ship prepaid COM material to:
 JSI
 Attn: COM Dept
 932 Mill Street
 Jasper, IN 47546

Application of fabric:
 Railroaded Up the Roll

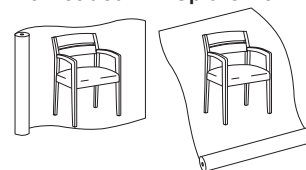

All COM orders will ship at standard lead time from receipt of COM except for orders requiring special custom matched finishes.

5. Optional Casters - add \$92 list; specify color.

- Color:**
- Black
 - Antique Brass

6. Optional Rubber Cushion Nylon Glides - no upcharge

GUEST

Description	1 Model	Specifications			List Price Per Grade	
Guest Chair 	GL6481P · plain back slats · upholstered seat	Dimensions	D	W	H	COM \$831
		Overall	24 ¼	21	32 ¾	A \$840
		Seat	20	18 ¾	19 ¾	B \$857
		Arm			26 ¼	COL/C \$888
		Upholstery	Shipping			D \$928
		COM Ydg	1	Ctn Wt	26	E \$966
		COL Sq Ft	18	Cu Ft	20	F \$1,007
						G \$1,066
						H \$1,128
						I \$1,227
				J \$1,343		
				L1 \$1,078		
				L2 \$1,141		

Description	1 Model	Specifications			List Price Per Grade	
Guest Chair 	GL6481C · circle detail back · upholstered seat	Dimensions	D	W	H	COM \$831
		Overall	24 ¼	21	32 ¾	A \$840
		Seat	20	18 ¾	19 ¾	B \$857
		Arm			26 ¼	COL/C \$888
		Upholstery	Shipping			D \$928
		COM Ydg	1	Ctn Wt	26	E \$966
		COL Sq Ft	18	Cu Ft	20	F \$1,007
						G \$1,066
						H \$1,128
						I \$1,227
				J \$1,343		
				L1 \$1,078		
				L2 \$1,141		

GUEST

To Order, Specify:

- 1 Model Number
- 2 Wood Species - Maple (M)
- 3 Wood Finish
- 4 Fabric Selection - vendor, pattern and color
- 5 Optional Casters - add \$92 list; specify color
- 6 Optional Rubber Cushion Nylon Glides - no upcharge

3 Wood Finish Options:

ALE Ale	FLX Flax
AUB Auburn	CGR Graphite Coordinate
AUT Autumn	CHL High Line Coordinate
BRL Barley	CKC Khaki Coordinate
CBE Blonde Echo Coordinate	LGC Legacy
BBN Bourbon	MCH Mocha
CBZ Brazilwood Coordinate	NTO Night Owl
BRG Brighton	PRL Praline
BUT Butterscotch	SAF Saffron
CIN Cinnamon	SIE Sienna
CLA Classic	CST Studio Teak Coordinate
CCF Coffee Coordinate	TOF Toffee
CCR Cremello Coordinate	TRF Truffle
EAR Earthy	VEN Venetian
ESP Espresso	CWH Walnut Heights Coordinate

Specifications

- Wood species - Maple.
- Seat has synthetic sheet webbing and 2 ½" high density polyurethane foam and polyurethane overlay.
- Back has steam bent back slats.
- Mortise and tenon construction with corner blocks, glue and screws.
- Standard with rubber cushion metal glides.

- 4 See a selection of graded in fabric manufacturers and patterns on pages 12-20. Contact Customer Service for additional fabric options.

Gatsby Order Check List:



Specify:

- 1. Model Number
- 2. Wood Species - Maple (M)
- 3. Wood Finish
- 4. Fabric Selection - vendor, pattern and color
- 5. Optional Black Anti-Microbial Polyurethane Arm Caps
 - A. Single Seat - add \$91 list
 - B. Two Seat Tandem - add \$136 list
 - C. Three Seat Tandem - add \$181 list
 - D. Four Seat Tandem - add \$226 list
- 6. Optional Rubber Cushion Nylon Glides - no upcharge

Example:

GT4901E | M | AUB | MOMENTUM | VOX | MYSTIC
 (model #) | (wood species) | (finish) | (fabric vendor) | (pattern name) | (pattern color)

1. Model Number

2. Wood Species - Maple (M)

3. Wood Finish Options:

ALE Ale	FLX Flax
AUB Auburn	CGR Graphite Coordinate
AUT Autumn	CHL High Line Coordinate
BRL Barley	CKC Khaki Coordinate
CBE Blonde Echo Coordinate	LGC Legacy
BBN Bourbon	MCH Mocha
CBZ Brazilwood Coordinate	NTO Night Owl
BRG Brighton	PRL Praline
BUT Butterscotch	SAF Saffron
CIN Cinnamon	SIE Sienna
CLA Classic	CST Studio Teak Coordinate
CCF Coffee Coordinate	TOF Toffee
CCR Cremello Coordinate	TRF Truffle
EAR Earthy	VEN Venetian
ESP Espresso	CWH Walnut Heights Coordinate

4. Fabric Selection - Please supply the following:

- Fabric vendor
- Pattern name
- Pattern color

When specifying contrasting upholstery, indicate clearly which upholstery is to be applied to the seat and back. Use higher grade pricing.

- Indicate direction of fabric - Railroaded or Up the Roll
- Please provide illustration, if available

All COM orders must include the following:

- Vendor's name, pattern name and color
- Sample of the fabric attached to order
- Model numbers of items for fabric application
- Special application instructions (e.g., all stripes will be applied front to back unless specified otherwise)
- Customer and purchase order number

Ship prepaid COM material to:
 JSI
 Attn: COM Dept
 932 Mill Street
 Jasper, IN 47546

Application of fabric:
 Railroaded Up the Roll

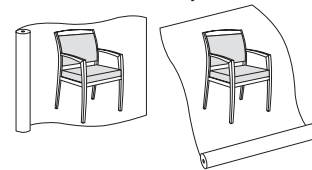

All COM orders will ship at standard lead time from receipt of COM except for orders requiring special custom matched finishes.

5. Optional Black Anti-Microbial Polyurethane Arm Caps

- A. Single Seat - add \$91 list
- B. Two Seat Tandem - add \$136 list
- C. Three Seat Tandem - add \$181 list
- D. Four Seat Tandem - add \$226 list



6. Optional Rubber Cushion Nylon Glides - no upcharge

7. Product Options - Special Finish: \$289 list upcharge

Description	1 Model	Specifications	List Price Per Grade												
Guest Chair 	GT4903D · upholstered seat · fully upholstered back · armless · solid hardwood back frame with synthetic sheet webbing and 3/4" high density polyurethane foam · pre-drilled to accept linking kit, see page 95 for kit	<table border="1"> <thead> <tr> <th>Dimensions</th> <th>D</th> <th>W</th> <th>H</th> </tr> </thead> <tbody> <tr> <td>Overall</td> <td>24 1/2</td> <td>22 1/8</td> <td>35 3/8</td> </tr> <tr> <td>Seat</td> <td>18 1/2</td> <td>20</td> <td>19</td> </tr> </tbody> </table>	Dimensions	D	W	H	Overall	24 1/2	22 1/8	35 3/8	Seat	18 1/2	20	19	COM 710 A 737 B 766 COL/C 816 D 882 E 949 F 1,052 G 1,162 H 1,278 I 1,462 J 1,682 L1 1,183 L2 1,300
		Dimensions	D	W	H										
Overall	24 1/2	22 1/8	35 3/8												
Seat	18 1/2	20	19												
<table border="1"> <thead> <tr> <th>Upholstery</th> <th colspan="2">Shipping</th> </tr> </thead> <tbody> <tr> <td>COM Ydg</td> <td>1 1/2</td> <td>Ctn Wt 30</td> </tr> <tr> <td>COL Sq Ft</td> <td>27</td> <td>Cu Ft 17</td> </tr> </tbody> </table>	Upholstery	Shipping		COM Ydg	1 1/2	Ctn Wt 30	COL Sq Ft	27	Cu Ft 17						
Upholstery	Shipping														
COM Ydg	1 1/2	Ctn Wt 30													
COL Sq Ft	27	Cu Ft 17													

Description	1 Model	Specifications	List Price Per Grade												
Guest Chair 	GT4903E · upholstered seat · 3/4 upholstered back · armless · solid hardwood back frame with synthetic sheet webbing and 3/4" high density polyurethane foam · pre-drilled to accept linking kit, see page 95 for kit	<table border="1"> <thead> <tr> <th>Dimensions</th> <th>D</th> <th>W</th> <th>H</th> </tr> </thead> <tbody> <tr> <td>Overall</td> <td>24 1/2</td> <td>22 1/8</td> <td>35 3/8</td> </tr> <tr> <td>Seat</td> <td>18 1/2</td> <td>20</td> <td>19</td> </tr> </tbody> </table>	Dimensions	D	W	H	Overall	24 1/2	22 1/8	35 3/8	Seat	18 1/2	20	19	COM 703 A 729 B 758 COL/C 809 D 875 E 941 F 1,044 G 1,153 H 1,271 I 1,455 J 1,674 L1 1,175 L2 1,293
		Dimensions	D	W	H										
Overall	24 1/2	22 1/8	35 3/8												
Seat	18 1/2	20	19												
<table border="1"> <thead> <tr> <th>Upholstery</th> <th colspan="2">Shipping</th> </tr> </thead> <tbody> <tr> <td>COM Ydg</td> <td>1 1/2</td> <td>Ctn Wt 29</td> </tr> <tr> <td>COL Sq Ft</td> <td>27</td> <td>Cu Ft 17</td> </tr> </tbody> </table>	Upholstery	Shipping		COM Ydg	1 1/2	Ctn Wt 29	COL Sq Ft	27	Cu Ft 17						
Upholstery	Shipping														
COM Ydg	1 1/2	Ctn Wt 29													
COL Sq Ft	27	Cu Ft 17													

Description	1 Model	Specifications	List Price Per Grade												
Guest Chair 	GT4903F · upholstered seat · veneer plywood back panel · armless · pre-drilled to accept linking kit, see page 95 for kit	<table border="1"> <thead> <tr> <th>Dimensions</th> <th>D</th> <th>W</th> <th>H</th> </tr> </thead> <tbody> <tr> <td>Overall</td> <td>24 1/2</td> <td>22 1/8</td> <td>35 3/8</td> </tr> <tr> <td>Seat</td> <td>18 1/2</td> <td>20</td> <td>19</td> </tr> </tbody> </table>	Dimensions	D	W	H	Overall	24 1/2	22 1/8	35 3/8	Seat	18 1/2	20	19	COM 640 A 659 B 676 COL/C 706 D 744 E 783 F 843 G 907 H 975 I 1,082 J 1,210 L1 919 L2 987
		Dimensions	D	W	H										
Overall	24 1/2	22 1/8	35 3/8												
Seat	18 1/2	20	19												
<table border="1"> <thead> <tr> <th>Upholstery</th> <th colspan="2">Shipping</th> </tr> </thead> <tbody> <tr> <td>COM Ydg</td> <td>7/8</td> <td>Ctn Wt 26</td> </tr> <tr> <td>COL Sq Ft</td> <td>16</td> <td>Cu Ft 17</td> </tr> </tbody> </table>	Upholstery	Shipping		COM Ydg	7/8	Ctn Wt 26	COL Sq Ft	16	Cu Ft 17						
Upholstery	Shipping														
COM Ydg	7/8	Ctn Wt 26													
COL Sq Ft	16	Cu Ft 17													

To Order, Specify:

- 1 Model Number
- 2 Wood Species - Maple (M)
- 3 Wood Finish
- 4 Fabric Selection - vendor, pattern and color
- 5 Optional Rubber Cushion Nylon Glides - no upcharge

3 Wood Finish Options:

ALE Ale	FLX Flax
AUB Auburn	CGR Graphite Coordinate
AUT Autumn	CHL High Line Coordinate
BRL Barley	CKC Khaki Coordinate
CBE Blonde Echo Coordinate	LGC Legacy
BBN Bourbon	MCH Mocha
CBZ Brazilwood Coordinate	NTO Night Owl
BRG Brighton	PRL Praline
BUT Butterscotch	SAF Saffron
CIN Cinnamon	SIE Sienna
CLA Classic	CST Studio Teak Coordinate
CCF Coffee Coordinate	TOF Toffee
CCR Cremello Coordinate	TRF Truffle
EAR Earthy	VEN Venetian
ESP Espresso	CWH Walnut Heights Coordinate

Specifications

- Wood species - Maple.
- Mortise and tenon construction with corner blocks, glue and screws.
- Seat has 1/2" plywood with synthetic sheet webbing and 2 1/2" high density polyurethane foam.
- Wall saver feature.
- Standard with rubber cushion metal glides.

When ordering Quickship products, place a "Q" in front of model number.
 Example: QGT4901D

Need it.
 JSI Quickship **NOW!**

- 4 See a selection of graded fabric manufacturers and patterns on pages 12-20. Contact Customer Service for additional fabric options.

Description	① Model	Specifications				List Price Per Grade
		Dimensions	D	W	H	
Guest Chair 	GT4903G · upholstered seat · upholstered plywood back panel with 1/2" high density polyurethane foam · armless · pre-drilled to accept linking kit, see page 95 for kit	Overall	24 1/2	22 1/8	35 3/8	COM 655
		Seat	18 1/2	20	19	A 674
		Upholstery		Shipping		B 690
		COM Ydg	7/8	Ctn Wt	27	COL/C 721
		COL Sq Ft	16	Cu Ft	17	D 759
						E 797
						F 857
						G 921
						H 990
						I 1,097
						J 1,225
						L1 934
						L2 1,003

Description	① Model	Specifications				List Price Per Grade
		Dimensions	D	W	H	
Guest Chair 	GT4903I · upholstered seat · vertical slat back · steam bent slats · armless · pre-drilled to accept linking kit, see page 95 for kit	Overall	24 1/2	22 1/8	35 3/8	COM 714
		Seat	18 1/2	20	19	A 734
		Upholstery		Shipping		B 751
		COM Ydg	7/8	Ctn Wt	26	COL/C 782
		COL Sq Ft	16	Cu Ft	17	D 819
						E 858
						F 918
						G 982
						H 1,050
						I 1,158
						J 1,286
						L1 995
						L2 1,063

Description	① Model	Specifications				List Price Per Grade
		Dimensions	D	W	H	
Guest Chair 	GT4903J · upholstered seat · upholstered vertical slat back · steam bent slats with 3/4" high density polyurethane foam · armless · pre-drilled to accept linking kit, see page 95 for kit	Overall	24 1/2	22 1/8	35 3/8	COM 752
		Seat	18 1/2	20	19	A 779
		Upholstery		Shipping		B 808
		COM Ydg	1 1/2	Ctn Wt	29	COL/C 859
		COL Sq Ft	27	Cu Ft	17	D 926
						E 992
						F 1,094
						G 1,204
						H 1,321
						I 1,504
						J 1,725
						L1 1,226
						L2 1,343

GUEST

Description	1 Model	Specifications			List Price Per Grade	
Guest Chair 	GT4901D · upholstered seat · fully upholstered back · solid hardwood back frame with synthetic sheet webbing and ¾" high density polyurethane foam · pre-drilled to accept linking kit, see page 95 for kit	Dimensions	D	W	H	COM \$710
		Overall	24 ½	22 ½	35 ¾	A \$737
		Seat	18 ¼	20	19	B \$766
		Arm			25 ¾	COL/C \$816
		Upholstery	Shipping			D \$882
		COM Ydg	1 ½	Ctn Wt	30	E \$949
		COL Sq Ft	27	Cu Ft	17	F \$1,052
						G \$1,162
						H \$1,278
						I \$1,462
				J \$1,682		
				L1 \$1,183		
				L2 \$1,300		

Guest Chair 	GT4901E · upholstered seat · ¾ upholstered back · solid hardwood back frame with synthetic sheet webbing and ¾" high density polyurethane foam · pre-drilled to accept linking kit, see page 95 for kit	Dimensions	D	W	H	COM \$703
		Overall	24 ½	22 ½	35 ¾	A \$729
		Seat	18 ¼	20	19	B \$758
		Arm			25 ¾	COL/C \$809
		Upholstery	Shipping			D \$875
		COM Ydg	1 ½	Ctn Wt	29	E \$941
		COL Sq Ft	27	Cu Ft	17	F \$1,044
						G \$1,153
						H \$1,271
						I \$1,455
				J \$1,674		
				L1 \$1,175		
				L2 \$1,293		

Guest Chair 	GT4901F · upholstered seat · veneer plywood back panel · pre-drilled to accept linking kit, see page 95 for kit	Dimensions	D	W	H	COM \$640
		Overall	24 ½	22 ½	35 ¾	A \$659
		Seat	19	20	19	B \$676
		Arm			25 ¾	COL/C \$706
		Upholstery	Shipping			D \$744
		COM Ydg	¾	Ctn Wt	26	E \$783
		COL Sq Ft	16	Cu Ft	17	F \$843
						G \$907
						H \$975
						I \$1,082
				J \$1,210		
				L1 \$919		
				L2 \$987		

To Order, Specify:

- 1 Model Number
- 2 Wood Species - Maple (M)
- 3 Wood Finish
- 4 Fabric Selection - vendor, pattern and color
- 5 Optional Black Anti-Microbial Polyurethane Arm Caps - add \$91 list
- 6 Optional Rubber Cushion Nylon Glides - no upcharge

3 Wood Finish Options:

ALE Ale	FLX Flax
AUB Auburn	CGR Graphite Coordinate
AUT Autumn	CHL High Line Coordinate
BRL Barley	CKC Khaki Coordinate
CBE Blonde Echo Coordinate	LGC Legacy
BBN Bourbon	MCH Mocha
CBZ Brazilwood Coordinate	NTO Night Owl
BRG Brighton	PRL Praline
BUT Butterscotch	SAF Saffron
CIN Cinnamon	SIE Sienna
CLA Classic	CST Studio Teak Coordinate
CCF Coffee Coordinate	TOF Toffee
CCR Cremello Coordinate	TRF Truffle
EAR Earthy	VEN Venetian
ESP Espresso	CWH Walnut Heights Coordinate

Specifications

- Wood species - Maple.
- Mortise and tenon construction with corner blocks, glue and screws.
- Seat has ½" plywood with synthetic sheet webbing and 2 ½" high density polyurethane foam.
- Wall saver feature.
- Standard with rubber cushion metal glides.

When ordering Quickship products, place a "Q" in front of model number.
 Example: QGT4901D

NOW!
Need it.
 JSI Quickship

- 4 See a selection of graded fabric manufacturers and patterns on pages 12-20. Contact Customer Service for additional fabric options.

Description	① Model	Specifications				List Price Per Grade
		Dimensions	D	W	H	
Guest Chair 	GT4901G · upholstered seat · upholstered plywood back panel with ½" high density polyurethane foam · pre-drilled to accept linking kit, see page 95 for kit	Overall	24 ½	22 ⅛	35 ⅜	COM \$655
		Seat	18 ½	20	19	A \$674
		Arm			25 ⅞	B \$690
		Upholstery		Shipping		COL/C \$721
		COM Ydg	⅞	Ctn Wt	27	D \$759
		COL Sq Ft	16	Cu Ft	17	E \$797
						F \$857
						G \$921
						H \$990
						I \$1,097
						J \$1,225
						L1 \$934
						L2 \$1,003

Description	① Model	Specifications				List Price Per Grade
		Dimensions	D	W	H	
Guest Chair 	GT4901I · upholstered seat · vertical slat back · steam bent slats · pre-drilled to accept linking kit, see page 95 for kit	Overall	24 ½	22 ⅛	35 ⅜	COM \$714
		Seat	19	20	19	A \$734
		Arm			25 ⅞	B \$751
		Upholstery		Shipping		COL/C \$782
		COM Ydg	⅞	Ctn Wt	26	D \$819
		COL Sq Ft	16	Cu Ft	17	E \$858
						F \$918
						G \$982
						H \$1,050
						I \$1,158
						J \$1,286
						L1 \$995
						L2 \$1,063

Description	① Model	Specifications				List Price Per Grade
		Dimensions	D	W	H	
Guest Chair 	GT4901J · upholstered seat · upholstered vertical slat back · steam bent slats with ¾" high density polyurethane foam · pre-drilled to accept linking kit, see page 95 for kit	Overall	24 ½	22 ⅛	35 ⅜	COM \$752
		Seat	18 ¼	20	19	A \$779
		Arm			25 ⅞	B \$808
		Upholstery		Shipping		COL/C \$859
		COM Ydg	1 ½	Ctn Wt	29	D \$926
		COL Sq Ft	27	Cu Ft	17	E \$992
						F \$1,094
						G \$1,204
						H \$1,321
						I \$1,504
						J \$1,725
						L1 \$1,226
						L2 \$1,343



upholstered vertical slat back

GUEST

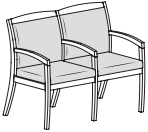
Description	Model	Specifications			List Price Per Grade		
		Dimensions	D	W	H	COM	
Two Seat Tandem Guest Chair 	GT4992D <ul style="list-style-type: none"> · upholstered seat · fully upholstered back · solid hardwood back frame with synthetic sheet webbing and 3/4" high density polyurethane foam · pre-drilled to accept linking kit, see page 95 for kit 	Overall	24 1/2	43 1/8	35 3/8	COM	\$1,275
		Seat	18 1/4	20	19	A	\$1,325
		Arm			25 7/8	B	\$1,383
		Upholstery		Shipping		COL/C	\$1,485
		COM Ydg	3	Ctn Wt	48	D	\$1,617
		COL Sq Ft	54	Cu Ft	25	E	\$1,750
						F	\$1,955
						G	\$2,175
						H	\$2,409
						I	\$2,776
						J	\$3,216
						L1	\$2,218
						L2	\$2,453

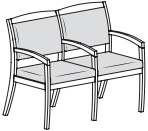
Description	Model	Specifications			List Price Per Grade		
		Dimensions	D	W	H	COM	
Two Seat Tandem Guest Chair 	GT4992E <ul style="list-style-type: none"> · upholstered seat · 3/4 upholstered back · solid hardwood back frame with synthetic sheet webbing and 3/4" high density polyurethane foam · pre-drilled to accept linking kit, see page 95 for kit 	Overall	24 1/2	43 1/8	35 3/8	COM	\$1,264
		Seat	18 1/4	20	19	A	\$1,313
		Arm			25 7/8	B	\$1,371
		Upholstery		Shipping		COL/C	\$1,474
		COM Ydg	3	Ctn Wt	47	D	\$1,606
		COL Sq Ft	54	Cu Ft	25	E	\$1,737
						F	\$1,943
						G	\$2,162
						H	\$2,398
						I	\$2,764
						J	\$3,204
						L1	\$2,207
						L2	\$2,441

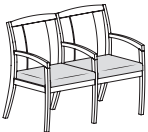
Description	Model	Specifications			List Price Per Grade		
		Dimensions	D	W	H	COM	
Two Seat Tandem Guest Chair 	GT4992F <ul style="list-style-type: none"> · upholstered seat · veneer plywood back panel · pre-drilled to accept linking kit, see page 95 for kit 	Overall	24 1/2	43 1/8	35 3/8	COM	\$1,175
		Seat	19	20	19	A	\$1,211
		Arm			25 7/8	B	\$1,245
		Upholstery		Shipping		COL/C	\$1,305
		COM Ydg	1 3/4	Ctn Wt	44	D	\$1,381
		COL Sq Ft	32	Cu Ft	25	E	\$1,459
						F	\$1,579
						G	\$1,707
						H	\$1,843
						I	\$2,057
						J	\$2,314
						L1	\$1,732
						L2	\$1,869

To Order, Specify:

- Model Number
- Wood Species - Maple (M)
- Wood Finish
- Fabric Selection - vendor, pattern and color
- Optional Black Anti-Microbial Polyurethane Arm Caps
 - A. Single Seat - add \$91 list
 - B. Two Seat Tandem - add \$136 list
- Optional Rubber Cushion Nylon Glides - no upcharge

Wood Finish Options:

- | | |
|----------------------------|-------------------------------|
| ALE Ale | FLX Flax |
| AUB Auburn | CGR Graphite Coordinate |
| AUT Autumn | CHL High Line Coordinate |
| BRL Barley | CKC Khaki Coordinate |
| CBE Blonde Echo Coordinate | LGC Legacy |
| BBN Bourbon | MCH Mocha |
| CBZ Brazilwood Coordinate | NTO Night Owl |
| BRG Brighton | PRL Praline |
| BUT Butterscotch | SAF Saffron |
| CIN Cinnamon | SIE Sienna |
| CLA Classic | CST Studio Teak Coordinate |
| CCF Coffee Coordinate | TOF Toffee |
| CCR Cremello Coordinate | TRF Truffle |
| EAR Earthy | VEN Venetian |
| ESP Espresso | CWH Walnut Heights Coordinate |

Specifications

- Wood species - Maple.
- Mortise and tenon construction with corner blocks, glue and screws.
- Seat has 1/2" plywood with synthetic sheet webbing and 2 1/2" high density polyurethane foam.
- Wall saver feature.
- Standard with rubber cushion metal glides.

When ordering Quickship products, place a "Q" in front of model number.
Example: QGT4901D

Now!
Need it.
JSI Quickship

- See a selection of graded in fabric manufacturers and patterns on pages 12-20. Contact Customer Service for additional fabric options.

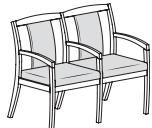
Description	① Model	Specifications			List Price Per Grade	
		Dimensions	D	W		H
Two Seat Tandem Guest Chair 	GT4992G · upholstered seat · upholstered plywood back panel with 1/2" high density polyurethane foam · pre-drilled to accept linking kit, see page 95 for kit	Overall	24 1/2	43 1/8	35 3/8	COM \$1,260
		Seat	18 1/2	20	19	A \$1,297
		Arm			25 7/8	B \$1,331
		Upholstery		Shipping		COL/C \$1,391
		COM Ydg	1 3/4	Ctn Wt	46	D \$1,468
		COL Sq Ft	32	Cu Ft	25	E \$1,545
						F \$1,665
						G \$1,793
						H \$1,930
						I \$2,144
						J \$2,400
						L1 \$1,819
						L2 \$1,956

Description	① Model	Specifications			List Price Per Grade	
		Dimensions	D	W		H
Two Seat Tandem Guest Chair 	GT4992I · upholstered seat · vertical slat back · steam bent slats · pre-drilled to accept linking kit, see page 95 for kit	Overall	24 1/2	43 1/8	35 3/8	COM \$1,335
		Seat	19	20	19	A \$1,373
		Arm			25 7/8	B \$1,406
		Upholstery		Shipping		COL/C \$1,466
		COM Ydg	1 3/4	Ctn Wt	46	D \$1,544
		COL Sq Ft	32	Cu Ft	25	E \$1,621
						F \$1,740
						G \$1,868
						H \$2,006
						I \$2,219
						J \$2,476
						L1 \$1,895
						L2 \$2,031

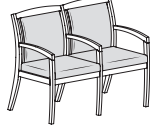
Description	① Model	Specifications			List Price Per Grade	
		Dimensions	D	W		H
Two Seat Tandem Guest Chair 	GT4992J · upholstered seat · upholstered vertical slat back · steam bent slats with 3/4" high density polyurethane foam · pre-drilled to accept linking kit, see page 95 for kit	Overall	24 1/2	43 1/8	35 3/8	COM \$1,370
		Seat	18 1/4	20	19	A \$1,420
		Arm			25 7/8	B \$1,479
		Upholstery		Shipping		COL/C \$1,582
		COM Ydg	3	Ctn Wt	48	D \$1,713
		COL Sq Ft	54	Cu Ft	25	E \$1,845
						F \$2,050
						G \$2,271
						H \$2,505
						I \$2,871
						J \$3,311
						L1 \$2,315
						L2 \$2,549

GUEST

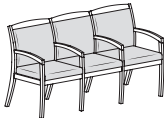
Description	Model	Specifications			List Price Per Grade		
Three Seat Tandem Guest Chair 	GT4993D · upholstered seat · fully upholstered back · solid hardwood back frame with synthetic sheet webbing and ¾" high density polyurethane foam · pre-drilled to accept linking kit, see page 95 for kit	Dimensions	D	W	H	COM	\$1,796
		Overall	24 ½	64 ½	35 ¾	A	\$1,867
		Seat	18 ¼	20	19	B	\$1,956
		Arm			25 ¾	COL/C	\$2,110
		Upholstery	Shipping		D	\$2,307	
		COM Ydg	4 ½	Ctn Wt	68	E	\$2,506
		COL Sq Ft	81	Cu Ft	37	F	\$2,813
						G	\$3,143
						H	\$3,495
						I	\$4,045
				J	\$4,704		
				L1	\$3,209		
				L2	\$3,561		

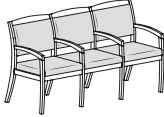
Description	Model	Specifications			List Price Per Grade		
Three Seat Tandem Guest Chair 	GT4993E · upholstered seat · ¾ upholstered back · solid hardwood back frame with synthetic sheet webbing and ¾" high density polyurethane foam · pre-drilled to accept linking kit, see page 95 for kit	Dimensions	D	W	H	COM	\$1,779
		Overall	24 ½	64 ½	35 ¾	A	\$1,851
		Seat	18 ¼	20	19	B	\$1,939
		Arm			25 ¾	COL/C	\$2,092
		Upholstery	Shipping		D	\$2,291	
		COM Ydg	4 ½	Ctn Wt	67	E	\$2,488
		COL Sq Ft	81	Cu Ft	37	F	\$2,796
						G	\$3,126
						H	\$3,478
						I	\$4,027
				J	\$4,688		
				L1	\$3,191		
				L2	\$3,543		

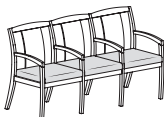
Description	Model	Specifications			List Price Per Grade		
Three Seat Tandem Guest Chair 	GT4993F · upholstered seat · veneer plywood back panel · pre-drilled to accept linking kit, see page 95 for kit	Dimensions	D	W	H	COM	\$1,622
		Overall	24 ½	64 ½	35 ¾	A	\$1,672
		Seat	19	20	19	B	\$1,724
		Arm			25 ¾	COL/C	\$1,814
		Upholstery	Shipping		D	\$1,929	
		COM Ydg	2 ¾	Ctn Wt	62	E	\$2,044
		COL Sq Ft	48	Cu Ft	37	F	\$2,223
						G	\$2,417
						H	\$2,621
						I	\$2,943
				J	\$3,327		
				L1	\$2,454		
				L2	\$2,660		

To Order, Specify:

- 1 Model Number
- 2 Wood Species - Maple (M)
- 3 Wood Finish
- 4 Fabric Selection - vendor, pattern and color
- 5 Optional Black Anti-Microbial Polyurethane Arm Caps
 - A. Two Seat Tandem - add \$136 list
 - B. Three Seat Tandem - add \$181 list
- 6 Optional Rubber Cushion Nylon Glides - no upcharge

3 Wood Finish Options:

- | | |
|----------------------------|-------------------------------|
| ALE Ale | FLX Flax |
| AUB Auburn | CGR Graphite Coordinate |
| AUT Autumn | CHL High Line Coordinate |
| BRL Barley | CKC Khaki Coordinate |
| CBE Blonde Echo Coordinate | LGC Legacy |
| BBN Bourbon | MCH Mocha |
| CBZ Brazilwood Coordinate | NTO Night Owl |
| BRG Brighton | PRL Praline |
| BUT Butterscotch | SAF Saffron |
| CIN Cinnamon | SIE Sienna |
| CLA Classic | CST Studio Teak Coordinate |
| CCF Coffee Coordinate | TOF Toffee |
| CCR Cremello Coordinate | TRF Truffle |
| EAR Earthy | VEN Venetian |
| ESP Espresso | CWH Walnut Heights Coordinate |

- 4 See a selection of graded fabric manufacturers and patterns on pages 12-20. Contact Customer Service for additional fabric options.

Specifications

- Wood species - Maple.
- Mortise and tenon construction with corner blocks, glue and screws.
- Seat has ½" plywood with synthetic sheet webbing and 2 ½" high density polyurethane foam.
- Wall saver feature.
- Standard with rubber cushion metal glides.

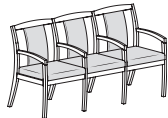
Description	① Model	Specifications			List Price Per Grade	
Three Seat Tandem Guest Chair 	GT4993G · upholstered seat · upholstered plywood back panel with 1/2" high density polyurethane foam · pre-drilled to accept linking kit, see page 95 for kit	Dimensions	D	W	H	COM \$1,768
		Overall	24 1/2	64 1/8	35 3/8	A \$1,820
		Seat	18 1/2	20	19	B \$1,872
		Arm			25 7/8	COL/C \$1,962
		Upholstery	Shipping			D \$2,077
		COM Ydg	2 5/8	Ctn Wt	65	E \$2,193
		COL Sq Ft	48	Cu Ft	37	F \$2,372
						G \$2,565
						H \$2,769
						I \$3,091
						J \$3,475
						L1 \$2,602
						L2 \$2,808

Description	① Model	Specifications			List Price Per Grade	
Three Seat Tandem Guest Chair 	GT4993I · upholstered seat · vertical slat back · steam bent slats · pre-drilled to accept linking kit, see page 95 for kit	Dimensions	D	W	H	COM \$1,853
		Overall	24 1/2	64 1/8	35 3/8	A \$1,906
		Seat	19	20	19	B \$1,958
		Arm			25 7/8	COL/C \$2,048
		Upholstery	Shipping			D \$2,163
		COM Ydg	2 5/8	Ctn Wt	65	E \$2,279
		COL Sq Ft	48	Cu Ft	37	F \$2,459
						G \$2,651
						H \$2,855
						I \$3,177
						J \$3,561
						L1 \$2,690
						L2 \$2,894

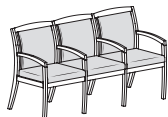
Description	① Model	Specifications			List Price Per Grade	
Three Seat Tandem Guest Chair 	GT4993J · upholstered seat · upholstered vertical slat back · steam bent slats with 3/4" high density polyurethane foam · pre-drilled to accept linking kit, see page 95 for kit	Dimensions	D	W	H	COM \$1,939
		Overall	24 1/2	64 1/8	35 3/8	A \$2,012
		Seat	18 1/4	20	19	B \$2,100
		Arm			25 7/8	COL/C \$2,255
		Upholstery	Shipping			D \$2,452
		COM Ydg	4 1/2	Ctn Wt	68	E \$2,651
		COL Sq Ft	81	Cu Ft	37	F \$2,958
						G \$3,288
						H \$3,640
						I \$4,190
						J \$4,849
						L1 \$3,354
						L2 \$3,706

GUEST

Description	Model	Specifications				List Price Per Grade	
		Dimensions	D	W	H	COM	
Four Seat Tandem Guest Chair 	GT4994D <ul style="list-style-type: none"> upholstered seat fully upholstered back solid hardwood back frame with synthetic sheet webbing and 3/4" high density polyurethane foam pre-drilled to accept linking kit, see page 95 for kit 	Overall	24 1/2	85 1/8	35 3/8	COM	\$2,325
		Seat	18 1/4	20	19	A	\$2,420
		Arm			25 7/8	B	\$2,536
		Upholstery		Shipping		COL/C	\$2,742
		COM Ydg	6	Ctn Wt	88	D	\$3,006
		COL Sq Ft	108	Cu Ft	49	E	\$3,270
						F	\$3,680
						G	\$4,120
						H	\$4,589
						I	\$5,322
						J	\$6,202
						L1	\$4,208
						L2	\$4,677

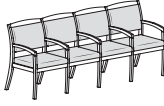
Description	Model	Specifications				List Price Per Grade	
		Dimensions	D	W	H	COM	
Four Seat Tandem Guest Chair 	GT4994E <ul style="list-style-type: none"> upholstered seat 3/4 upholstered back solid hardwood back frame with synthetic sheet webbing and 3/4" high density polyurethane foam pre-drilled to accept linking kit, see page 95 for kit 	Overall	24 1/2	85 1/8	35 3/8	COM	\$2,302
		Seat	18 1/4	20	19	A	\$2,396
		Arm			25 7/8	B	\$2,513
		Upholstery		Shipping		COL/C	\$2,719
		COM Ydg	6	Ctn Wt	86	D	\$2,982
		COL Sq Ft	108	Cu Ft	49	E	\$3,246
						F	\$3,657
						G	\$4,097
						H	\$4,566
						I	\$5,299
						J	\$6,179
						L1	\$4,185
						L2	\$4,653

Description	Model	Specifications				List Price Per Grade	
		Dimensions	D	W	H	COM	
Four Seat Tandem Guest Chair 	GT4994F <ul style="list-style-type: none"> upholstered seat veneer plywood back panel pre-drilled to accept linking kit, see page 95 for kit 	Overall	24 1/2	85 1/8	35 3/8	COM	\$2,064
		Seat	19	20	19	A	\$2,130
		Arm			25 7/8	B	\$2,198
		Upholstery		Shipping		COL/C	\$2,318
		COM Ydg	3 1/2	Ctn Wt	79	D	\$2,471
		COL Sq Ft	63	Cu Ft	49	E	\$2,625
						F	\$2,865
						G	\$3,121
						H	\$3,395
						I	\$3,822
						J	\$4,336
						L1	\$3,173
						L2	\$3,447

To Order, Specify:

- 1 Model Number
- 2 Wood Species - Maple (M)
- 3 Wood Finish
- 4 Fabric Selection - vendor, pattern and color
- 5 Optional Black Anti-Microbial Polyurethane Arm Caps
 - A. Three Seat Tandem - add \$181 list
 - B. Four Seat Tandem - add \$226 list
- 6 Optional Rubber Cushion Nylon Glides - no upcharge

3 Wood Finish Options:

- | | |
|----------------------------|-------------------------------|
| ALE Ale | FLX Flax |
| AUB Auburn | CGR Graphite Coordinate |
| AUT Autumn | CHL High Line Coordinate |
| BRL Barley | CKC Khaki Coordinate |
| CBE Blonde Echo Coordinate | LGC Legacy |
| BBN Bourbon | MCH Mocha |
| CBZ Brazilwood Coordinate | NTO Night Owl |
| BRG Brighton | PRL Praline |
| BUT Butterscotch | SAF Saffron |
| CIN Cinnamon | SIE Sienna |
| CLA Classic | CST Studio Teak Coordinate |
| CCF Coffee Coordinate | TOF Toffee |
| CCR Cremello Coordinate | TRF Truffle |
| EAR Earthy | VEN Venetian |
| ESP Espresso | CWH Walnut Heights Coordinate |

Specifications

- Wood species - Maple.
- Mortise and tenon construction with corner blocks, glue and screws.
- Seat has 1/2" plywood with synthetic sheet webbing and 2 1/2" high density polyurethane foam.
- Wall saver feature.
- Standard with rubber cushion metal glides.

- 4 See a selection of graded fabric manufacturers and patterns on pages 12-20. Contact Customer Service for additional fabric options.

GUEST

Description	① Model	Specifications			List Price Per Grade	
		Dimensions	D	W		H
Four Seat Tandem Guest Chair 	GT4994G · upholstered seat · upholstered plywood back panel with 1/2" high density polyurethane foam · pre-drilled to accept linking kit, see page 95 for kit	Overall	24 1/2	85 1/8	35 3/8	COM \$2,272
		Seat	18 1/2	20	19	A \$2,341
		Arm			25 7/8	B \$2,409
		Upholstery		Shipping		COL/C \$2,529
		COM Ydg	3 1/2	Ctn Wt	85	D \$2,682
		COL Sq Ft	63	Cu Ft	49	E \$2,837
						F \$3,076
						G \$3,332
						H \$3,606
						I \$4,034
						J \$4,547
						L1 \$3,384
						L2 \$3,658

Description	① Model	Specifications			List Price Per Grade	
		Dimensions	D	W		H
Four Seat Tandem Guest Chair 	GT4994I · upholstered seat · vertical slat back · steam bent slats · pre-drilled to accept linking kit, see page 95 for kit	Overall	24 1/2	85 1/8	35 3/8	COM \$2,366
		Seat	19	20	19	A \$2,436
		Arm			25 7/8	B \$2,505
		Upholstery		Shipping		COL/C \$2,624
		COM Ydg	3 1/2	Ctn Wt	85	D \$2,779
		COL Sq Ft	63	Cu Ft	49	E \$2,932
						F \$3,171
						G \$3,429
						H \$3,702
						I \$4,130
						J \$4,643
						L1 \$3,480
						L2 \$3,753

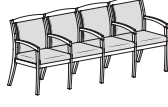
Description	① Model	Specifications			List Price Per Grade	
		Dimensions	D	W		H
Four Seat Tandem Guest Chair 	GT4994J · upholstered seat · upholstered vertical slat back · steam bent slats with 3/4" high density polyurethane foam · pre-drilled to accept linking kit, see page 95 for kit	Overall	24 1/2	85 1/8	35 3/8	COM \$2,506
		Seat	18 1/4	20	19	A \$2,602
		Arm			25 7/8	B \$2,720
		Upholstery		Shipping		COL/C \$2,926
		COM Ydg	6	Ctn Wt	88	D \$3,189
		COL Sq Ft	108	Cu Ft	49	E \$3,453
						F \$3,863
						G \$4,303
						H \$4,773
						I \$5,506
						J \$6,384
						L1 \$4,392
						L2 \$4,860

GUEST

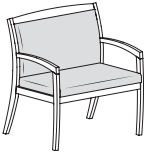
Description	Model	Specifications			List Price Per Grade		
		Dimensions	D	W	H	COM	
30" Bariatric Guest Chair 	GT4951D · upholstered seat · fully upholstered back · solid hardwood back frame with synthetic sheet webbing and ¾" high density polyurethane foam · pre-drilled to accept linking kit, see page 95 for kit · meets BIFMA x5.11 large occupant standard (253-400 lb individual)	Overall	24 ½	32 ½	35 ¾	COM	\$1,379
		Seat	18 ¼	30	19	COL/C	\$1,560
		Arm			25 ¾	D	\$1,669
		Upholstery		Shipping		E	\$1,779
		COM Ydg	2 ½	Ctn Wt	46	F	\$1,950
		COL Sq Ft	45	Cu Ft	19	G	\$2,133
						H	\$2,329
						I	\$2,634
						J	\$3,000
						L1	\$2,170
						L2	\$2,365

Description	Model	Specifications			List Price Per Grade		
		Dimensions	D	W	H	COM	
30" Bariatric Guest Chair 	GT4951E · upholstered seat · ¾ upholstered back · solid hardwood back frame with synthetic sheet webbing and ¾" high density polyurethane foam · pre-drilled to accept linking kit, see page 95 for kit · meets BIFMA x5.11 large occupant standard (253-400 lb individual)	Overall	24 ½	32 ½	35 ¾	COM	\$1,351
		Seat	18 ¼	30	19	COL/C	\$1,530
		Arm			25 ¾	D	\$1,641
		Upholstery		Shipping		E	\$1,751
		COM Ydg	2 ½	Ctn Wt	45	F	\$1,921
		COL Sq Ft	45	Cu Ft	19	G	\$2,105
						H	\$2,300
						I	\$2,606
						J	\$2,972
						L1	\$2,141
						L2	\$2,337

To Order, Specify:

- 1 Model Number
- 2 Wood Species - Maple (M)
- 3 Wood Finish
- 4 Fabric Selection - vendor, pattern and color
- 5 Optional Black Anti-Microbial Polyurethane Arm Caps
 - A. Single Seat - add \$91 list
 - B. Four Seat Tandem - add \$226 list
- 6 Optional Rubber Cushion Nylon Glides - no upcharge

3 Wood Finish Options:

ALE Ale	FLX Flax
AUB Auburn	CGR Graphite Coordinate
AUT Autumn	CHL High Line Coordinate
BRL Barley	CKC Khaki Coordinate
CBE Blonde Echo Coordinate	LGC Legacy
BBN Bourbon	MCH Mocha
CBZ Brazilwood Coordinate	NTO Night Owl
BRG Brighton	PRL Praline
BUT Butterscotch	SAF Saffron
CIN Cinnamon	SIE Sienna
CLA Classic	CST Studio Teak Coordinate
CCF Coffee Coordinate	TOF Toffee
CCR Cremello Coordinate	TRF Truffle
EAR Earthy	VEN Venetian
ESP Espresso	CWH Walnut Heights Coordinate

- 4 See a selection of graded in fabric manufacturers and patterns on pages 80-82. Contact Customer Service for additional fabric options.

Specifications

- Wood species - Maple.
- Mortise and tenon construction with corner blocks, glue and screws.
- Seat has ½" plywood with synthetic sheet webbing and 2 ½" high density polyurethane foam.
- Wall saver feature.
- Standard with rubber cushion metal glides.

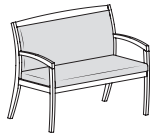
Description	① Model	Specifications				List Price Per Grade	
41" Bariatric Guest Chair 	GT4952D · upholstered seat · fully upholstered back · solid hardwood back frame with synthetic sheet webbing and ¾" high density polyurethane foam · pre-drilled to accept linking kit, see page 95 for kit · meets BIFMA x5.11 large occupant standard (253-400 lb individual)	Dimensions		D	W	H	COM \$1,511
		Overall	24 ½	43 ⅛	35 ⅜	A \$1,559	
		Seat	18 ¼	41	19	B \$1,608	
		Arm			25 ⅞	COL/C \$1,693	
		Upholstery		Shipping		D \$1,803	
		COM Ydg	2 ½	Ctn Wt	56	E \$1,914	
		COL Sq Ft	45	Cu Ft	25	F \$2,085	
						G \$2,267	
						H \$2,463	
						I \$2,768	
				J \$3,135			
				L1 \$2,304			
				L2 \$2,499			

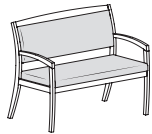
41" Bariatric Guest Chair 	GT4952E · upholstered seat · ¾ upholstered back · solid hardwood back frame with synthetic sheet webbing and ¾" high density polyurethane foam · pre-drilled to accept linking kit, see page 95 for kit · meets BIFMA x5.11 large occupant standard (253-400 lb individual)	Dimensions		D	W	H	COM \$1,484
		Overall	24 ½	43 ⅛	35 ⅜	A \$1,531	
		Seat	18 ¼	41	19	B \$1,581	
		Arm			25 ⅞	COL/C \$1,666	
		Upholstery		Shipping		D \$1,776	
		COM Ydg	2 ½	Ctn Wt	55	E \$1,885	
		COL Sq Ft	45	Cu Ft	25	F \$2,056	
						G \$2,240	
						H \$2,435	
						I \$2,741	
				J \$3,107			
				L1 \$2,277			
				L2 \$2,472			

GUEST

Description	D	W	H	CTN WT	CU FT	① Model	List Price
20" Center Linking Table	20 3/8	21 1/8	3 5/8	19	2	GT2021LT	\$660

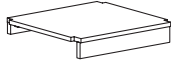

- attaches between single, bariatric or tandem units
- linking hardware included
- no tools required for installation
- ships KD

Comer Linking Table	31	31	16 7/8	35	4	GT3131CT	\$806
---------------------	----	----	--------	----	---	----------	-------

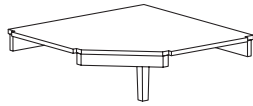

- attaches between single, bariatric or tandem units
- linking hardware included
- no tools required for installation
- ships KD

Chair Linking Kit						GT49BRKT	\$109
-------------------	--	--	--	--	--	----------	-------

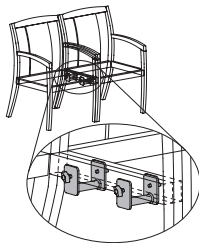
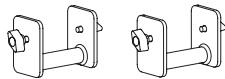

- kit contains two brackets and four thumb screws
- no tools required
- one kit required for each two guest chairs, bariatric chairs or tandem models that are to be linked together
- three models linked together require two kits, four models linked together require three kits, etc.

To Order, Specify:

- ① Model Number
- ② Wood Species - Maple (M)
- ③ Wood Finish
- ④ Fabric Selection - vendor, pattern and color
- ⑤ Optional Black Anti-Microbial Polyurethane Arm Caps - add \$91 list
- ⑥ Optional Rubber Cushion Nylon Glides - no upcharge

③ Wood Finish Options:

ALE Ale	FLX Flax
AUB Auburn	CGR Graphite Coordinate
AUT Autumn	CHL High Line Coordinate
BRL Barley	CKC Khaki Coordinate
CBE Blonde Echo Coordinate	LGC Legacy
BBN Bourbon	MCH Mocha
CBZ Brazilwood Coordinate	NTO Night Owl
BRG Brighton	PRL Praline
BUT Butterscotch	SAF Saffron
CIN Cinnamon	SIE Sienna
CLA Classic	CST Studio Teak Coordinate
CCF Coffee Coordinate	TOF Toffee
CCR Cremello Coordinate	TRF Truffle
EAR Earthy	VEN Venetian
ESP Espresso	CWH Walnut Heights Coordinate

Specifications

- Wood species - Maple.
- Mortise and tenon construction with corner blocks, glue and screws.
- Seat has a solid plywood seat board reinforced with a steel sub frame and 2 1/2" high density polyurethane foam.
- Standard with rubber cushion metal glides.
- Chair has a wall saver feature.
- Table has plain sliced book matched veneer tops.

- ④ See a selection of graded in fabric manufacturers and patterns on pages 12-20. Contact Customer Service for additional fabric options.

Harbor Order Check List:



Specify:

- 1. Model Number
- 2. Wood Species - Maple (M)
- 3. Wood Finish
- 4. Fabric Selection - vendor, pattern and color
- 5. Optional Casters - add \$92 list; specify color
- 6. Optional Rubber Cushion Nylon Glides - no upcharge

Example:

HB2901 | **M** | **AUB** | **MOMENTUM** | **VOX** | **MYSTIC**
 (model #) | (wood species) | (finish) | (fabric vendor) | (pattern name) | (pattern color)

1. Model Number

- Special application instructions (e.g., all stripes will be applied front to back unless specified otherwise)
- Customer and purchase order number

2. Wood Species - Maple (M)

3. Wood Finish Options:

ALE Ale	FLX Flax
AUB Auburn	CGR Graphite Coordinate
AUT Autumn	CHL High Line Coordinate
BRL Barley	CKC Khaki Coordinate
CBE Blonde Echo Coordinate	LGC Legacy
BBN Bourbon	MCH Mocha
CBZ Brazilwood Coordinate	NTO Night Owl
BRG Brighton	PRL Praline
BUT Butterscotch	SAF Saffron
CIN Cinnamon	SIE Sienna
CLA Classic	CST Studio Teak Coordinate
CCF Coffee Coordinate	TOF Toffee
CCR Cremello Coordinate	TRF Truffle
EAR Earthy	VEN Venetian
ESP Espresso	CWH Walnut Heights Coordinate

Ship prepaid COM material to:
 JSI
 Attn: COM Dept
 932 Mill Street
 Jasper, IN 47546

Application of fabric:
 Railroaded Up the Roll

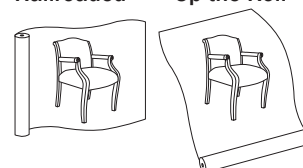

All COM orders will ship at standard lead time from receipt of COM except for orders requiring special custom matched finishes.

4. Fabric Selection - Please supply the following:

- Fabric vendor
- Pattern name
- Pattern color

When specifying contrasting upholstery, indicate clearly which upholstery is to be applied to the seat, back and arms. Use higher grade pricing.

- Indicate direction of fabric - Railroaded or Up the Roll
- Please provide illustration, if available

All COM orders must include the following:

- Vendor's name, pattern name and color
- Sample of the fabric attached to order
- Model numbers of items for fabric application

5. Optional Casters - add \$92 list; specify color.

- Color:**
- Black
 - Antique Brass

6. Optional Rubber Cushion Nylon Glides - no upcharge

For Harbor Swivel Seating, see page 39.

For Harbor Lounge Seating, see page 312.

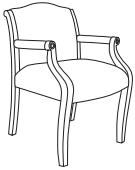
Description	Model	Specifications			List Price Per Grade		
		Dimensions	D	W	H	COM	
Guest Chair 	HB2901	Overall	26	24 3/4	34	COM	\$996
		Seat	18 1/2	20	19	A	\$1,014
		Arm			26 1/2	B	\$1,048
		Upholstery		Shipping		COL/C	\$1,109
		COM Ydg	2	Ctn Wt	40	D	\$1,188
		COL Sq Ft	36	Cu Ft	16	E	\$1,266
						F	\$1,349
						G	\$1,465
						H	\$1,590
						I	\$1,787
				J	\$2,021		
				L1	\$1,489		
				L2	\$1,614		

GUEST

To Order, Specify:

- 1 Model Number
- 2 Wood Species - Maple (M)
- 3 Wood Finish
- 4 Fabric Selection - vendor, pattern and color
- 5 Optional Casters - add \$92 list; specify color
- 6 Optional Rubber Cushion Nylon Glides - no upcharge

3 Wood Finish Options:

ALE Ale	FLX Flax
AUB Auburn	CGR Graphite Coordinate
AUT Autumn	CHL High Line Coordinate
BRL Barley	CKC Khaki Coordinate
CBE Blonde Echo Coordinate	LGC Legacy
BBN Bourbon	MCH Mocha
CBZ Brazilwood Coordinate	NTO Night Owl
BRG Brighton	PRL Praline
BUT Butterscotch	SAF Saffron
CIN Cinnamon	SIE Sienna
CLA Classic	CST Studio Teak Coordinate
CCF Coffee Coordinate	TOF Toffee
CCR Cremello Coordinate	TRF Truffle
EAR Earthy	VEN Venetian
ESP Espresso	CWH Walnut Heights Coordinate

- 4 See a selection of graded in fabric manufacturers and patterns on pages 12-20. Contact Customer Service for additional fabric options.

Specifications

- Wood species - Maple.
- Seat has synthetic sheet webbing and 2" polyurethane foam.
- Back has polypropylene webbing and 3 1/2" polyurethane foam.
- Spiral grooved hardwood dowels with corner blocks, glue and screws.
- Standard with rubber cushion metal glides.

Kendall Order Check List:



Specify:

- 1. Model Number
- 2. Wood Species - Beech (B)
- 3. Wood Finish
- 4. Fabric Selection - vendor, pattern and color
- 5. Optional Rubber Cushion Nylon Glides - no upcharge

Example:

KE6551D | B | AUB | MOMENTUM | VOX | MYSTIC
 (model #) | (wood species) | (finish) | (fabric vendor) | (pattern name) | (pattern color)

1. Model Number

2. Wood Species - Beech (B)

3. Wood Finish Options:

ALE Ale	FLX Flax
AUB Auburn	CGR Graphite Coordinate
AUT Autumn	CHL High Line Coordinate
BRL Barley	CKC Khaki Coordinate
CBE Blonde Echo Coordinate	LGC Legacy
BBN Bourbon	MCH Mocha
CBZ Brazilwood Coordinate	NTO Night Owl
BRG Brighton	PRL Praline
BUT Butterscotch	SAF Saffron
CIN Cinnamon	SIE Sienna
CLA Classic	CST Studio Teak Coordinate
CCF Coffee Coordinate	TOF Toffee
CCR Cremello Coordinate	TRF Truffle
EAR Earthy	VEN Venetian
ESP Espresso	CWH Walnut Heights Coordinate

4. Fabric Selection - Please supply the following:

- Fabric vendor
- Pattern name
- Pattern color

When specifying contrasting upholstery, indicate clearly which upholstery is to be applied to the seat, back and arms. Use higher grade pricing.

- Indicate direction of fabric - Railroaded or Up the Roll
- Please provide illustration, if available

All COM orders must include the following:

- Vendor's name, pattern name and color
- Sample of the fabric attached to order
- Model numbers of items for fabric application
- Special application instructions (e.g., all stripes will be applied front to back unless specified otherwise)
- Customer and purchase order number

Ship prepaid COM material to:
 JSI
 Attn: COM Dept
 932 Mill Street
 Jasper, IN 47546

Application of fabric:
 Railroaded Up the Roll

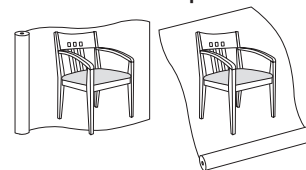

All COM orders will ship at standard lead time from receipt of COM except for orders requiring special custom matched finishes.

5. Optional Rubber Cushion Nylon Glides - no upcharge

GUEST

Description	Model	Specifications			List Price Per Grade		
		Dimensions	D	W	H	COM	
Guest Chair 	KE6551D · upholstered seat and back	Overall	23 1/2	22 1/2	33 1/4	COM	\$851
		Seat	18	18 1/2	18	A	\$860
		Arm			26 3/4	B	\$877
		Upholstery		Shipping		COL/C	\$908
		COM Ydg	1	Ctn Wt	30	D	\$948
		COL Sq Ft	18	Cu Ft	15	E	\$986
						F	\$1,027
						G	\$1,086
						H	\$1,148
						I	\$1,247
						J	\$1,363
						L1	\$1,098
						L2	\$1,161

Description	Model	Specifications			List Price Per Grade		
		Dimensions	D	W	H	COM	
Guest Chair 	KE6561C · upholstered seat · wood fan back	Overall	23 1/2	22 1/2	33 1/4	COM	\$773
		Seat	18	18 1/2	18	A	\$781
		Arm			26 3/4	B	\$793
		Upholstery		Shipping		COL/C	\$816
		COM Ydg	3/4	Ctn Wt	30	D	\$846
		COL Sq Ft	14	Cu Ft	15	E	\$875
						F	\$906
						G	\$950
						H	\$997
						I	\$1,070
						J	\$1,158
						L1	\$958
						L2	\$1,005

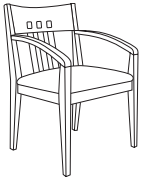
Description	Model	Specifications			List Price Per Grade		
		Dimensions	D	W	H	COM	
Guest Chair 	KE6571C · upholstered seat · vertical slat back/square detail	Overall	22 1/2	22 1/4	33 1/2	COM	\$773
		Seat	19	19	19	A	\$781
		Arm			27	B	\$793
		Upholstery		Shipping		COL/C	\$816
		COM Ydg	3/4	Ctn Wt	30	D	\$846
		COL Sq Ft	14	Cu Ft	15	E	\$875
						F	\$906
						G	\$950
						H	\$997
						I	\$1,070
						J	\$1,158
						L1	\$958
						L2	\$1,005

To Order, Specify:

- 1 Model Number
- 2 Wood Species - Beech (B)
- 3 Wood Finish
- 4 Fabric Selection - vendor, pattern and color
- 5 Optional Rubber Cushion Nylon Glides - no upcharge

3 Wood Finish Options:

ALE Ale	FLX Flax
AUB Auburn	CGR Graphite Coordinate
AUT Autumn	CHL High Line Coordinate
BRL Barley	CKC Khaki Coordinate
CBE Blonde Echo Coordinate	LGC Legacy
BBN Bourbon	MCH Mocha
CBZ Brazilwood Coordinate	NTO Night Owl
BRG Brighton	PRL Praline
BUT Butterscotch	SAF Saffron
CIN Cinnamon	SIE Sienna
CLA Classic	CST Studio Teak Coordinate
CCF Coffee Coordinate	TOF Toffee
CCR Cremello Coordinate	TRF Truffle
EAR Earthy	VEN Venetian
ESP Espresso	CWH Walnut Heights Coordinate



Specifications

- Wood species - Beech.
- Seat has 1 1/2" polyurethane foam.
- Back has 1" polyurethane foam.
- Mortise and tenon construction with corner blocks, glue and screws.
- Standard with rubber cushion metal glides.

When ordering Quickship products, place a "Q" in front of model number.
 Example: QGT4901D

Need it.
 JSI Quickship

- 4 See a selection of graded fabric manufacturers and patterns on pages 12-20. Contact Customer Service for additional fabric options.

Description	① Model	Specifications				List Price Per Grade	
		Dimensions	D	W	H	COM	
Guest Chair    exposed back design	KE6581D · upholstered seat and back · exposed horizontal slat back-side	Overall	22 ¼	22 ¾	32 ¾	COM	\$851
		Seat	16 ½	18 ¾	19 ¾	COL/C	\$908
		Arm	28 ¼			D	\$948
		Upholstery			Shipping	E	\$986
		COM Ydg	1	Ctn Wt	30	F	\$1,027
		COL Sq Ft	18	Cu Ft	12	G	\$1,086
						H	\$1,148
						I	\$1,247
						J	\$1,363
						L1	\$1,098
						L2	\$1,161

GUEST

To Order, Specify:

- ① Model Number
- ② Wood Species - Beech (B)
- ③ Wood Finish
- ④ Fabric Selection - vendor, pattern and color
- ⑤ Optional Rubber Cushion Nylon Glides - no upcharge

③ Wood Finish Options:

ALE Ale	FLX Flax
AUB Auburn	CGR Graphite Coordinate
AUT Autumn	CHL High Line Coordinate
BRL Barley	CKK Khaki Coordinate
CBE Blonde Echo Coordinate	LGC Legacy
BBN Bourbon	MCH Mocha
CBZ Brazilwood Coordinate	NTO Night Owl
BRG Brighton	PRL Praline
BUT Butterscotch	SAF Saffron
CIN Cinnamon	SIE Sienna
CLA Classic	CST Studio Teak Coordinate
CCF Coffee Coordinate	TOF Toffee
CCR Cremello Coordinate	TRF Truffle
EAR Earthy	VEN Venetian
ESP Espresso	CWH Walnut Heights Coordinate

Specifications

- Wood species - Beech.
- Seat has 1 ½" polyurethane foam.
- Back has 1" polyurethane foam.
- Mortise and tenon construction with corner blocks, glue and screws.
- Standard with rubber cushion metal glides.

When ordering Quickship products, place a "Q" in front of model number.
 Example: QGT4901D



- ④ See a selection of graded in fabric manufacturers and patterns on pages 12-20. Contact Customer Service for additional fabric options.

Laurel Order Check List:



Specify:

- 1. Model Number
- 2. Wood Species - Beech (B) (chairs) or Maple (M) (tables)
- 3. Wood Finish
- 4. Fabric Selection - vendor, pattern and color
- 5. Optional Anti-Microbial Arm Cap - add \$61 list per arm cap
- 6. Optional Rubber Cushion Nylon Glides - no upcharge; chairs only
- 7. Optional Coordinating Wood Grain Laminate Table Tops - no upcharge; tables only

Example:

LA1281 (model #)	B (wood species)	AUB (finish)	MOMENTUM (fabric vendor)	VOX (pattern name)	MYSTIC (pattern color)
----------------------------	----------------------------	------------------------	------------------------------------	------------------------------	----------------------------------

1. Model Number

- Special application instructions (e.g., all stripes will be applied front to back unless specified otherwise)
- Customer and purchase order number

2. Wood Species - Beech (B) (chairs) and Maple (M) (tables)

3. Wood Finish Options:

ALE Ale*	FLX Flax
AUB Auburn*	CGR Graphite Coordinate
AUT Autumn*	CHL High Line Coordinate*
BRL Barley*	CKC Khaki Coordinate
CBE Blonde Echo Coordinate*	LGC Legacy*
BBN Bourbon*	MCH Mocha*
CBZ Brazilwood Coordinate*	NTO Night Owl*
BRG Brighton*	PRL Praline*
BUT Butterscotch	SAF Saffron*
CIN Cinnamon*	SIE Sienna*
CLA Classic*	CST Studio Teak Coordinate*
CCF Coffee Coordinate	TOF Toffee*
CCR Cremello Coordinate	TRF Truffle*
EAR Earthy	VEN Venetian*
ESP Espresso	CWH Walnut Heights Coordinate*

Ship prepaid COM material to:
 JSI
 Attn: COM Dept
 932 Mill Street
 Jasper, IN 47546

Application of fabric:
 Railroaded Up the Roll

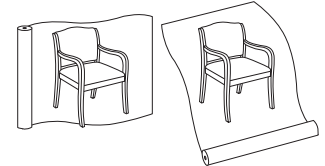

All COM orders will ship at standard lead time from receipt of COM except for orders requiring special custom matched finishes.

4. Fabric Selection - Please supply the following:

- Fabric vendor
- Pattern name
- Pattern color

When specifying contrasting upholstery, indicate clearly which upholstery is to be applied to the seat, back and arms. Use higher grade pricing.

- Indicate direction of fabric - Railroaded or Up the Roll
- Please provide illustration, if available

All COM orders must include the following:



- Fabric vendor's name, pattern name and color
- Sample of the fabric attached to order
- Model numbers of items for fabric application

5. Optional Anti-Microbial Arm Cap - add \$61 list per arm cap. Available on any Laurel model.

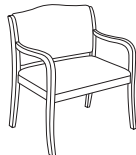
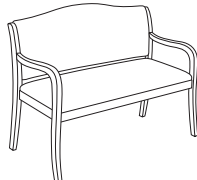

6. Optional Rubber Cushion Nylon Glides - no upcharge; chairs only

***7. Optional Coordinating Wood Grain Laminate Table Top - no upcharge; tables only. Finishes with an asterisk (*) have a coordinating laminate available.**

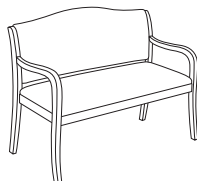
Description	① Model	Specifications	List Price Per Grade																
30" Bariatric 	LA1281B · meets BIFMA x5.11 large occupant standard (253-400 lb individual) · optional anti-microbial arm cap - add \$122 list	<table border="1"> <thead> <tr> <th>Dimensions</th> <th>D</th> <th>W</th> <th>H</th> </tr> </thead> <tbody> <tr> <td>Overall</td> <td>26</td> <td>32 ½</td> <td>34 ½</td> </tr> <tr> <td>Seat</td> <td>18 ¼</td> <td>30</td> <td>18</td> </tr> <tr> <td>Arm</td> <td></td> <td></td> <td>27 ½</td> </tr> </tbody> </table>	Dimensions	D	W	H	Overall	26	32 ½	34 ½	Seat	18 ¼	30	18	Arm			27 ½	COM \$1,448 A \$1,468 B \$1,507 COL/C \$1,577 D \$1,664 E \$1,752 F \$1,845 G \$1,977 H \$2,117 I \$2,338 J \$2,601 L1 \$2,003 L2 \$2,144
		Dimensions	D	W	H														
Overall	26	32 ½	34 ½																
Seat	18 ¼	30	18																
Arm			27 ½																
<table border="1"> <thead> <tr> <th>Upholstery</th> <th colspan="3">Shipping</th> </tr> </thead> <tbody> <tr> <td>COM Ydg</td> <td>2 ¼</td> <td>Ctn Wt</td> <td>43</td> </tr> <tr> <td>COL Sq Ft</td> <td>41</td> <td>Cu Ft</td> <td>23</td> </tr> </tbody> </table>	Upholstery	Shipping			COM Ydg	2 ¼	Ctn Wt	43	COL Sq Ft	41	Cu Ft	23							
Upholstery	Shipping																		
COM Ydg	2 ¼	Ctn Wt	43																
COL Sq Ft	41	Cu Ft	23																
42" Bariatric 	LA1282B · meets BIFMA x5.11 large occupant standard (253-400 lb individual) · optional anti-microbial arm cap - add \$122 list	<table border="1"> <thead> <tr> <th>Dimensions</th> <th>D</th> <th>W</th> <th>H</th> </tr> </thead> <tbody> <tr> <td>Overall</td> <td>26</td> <td>43 ½</td> <td>34 ½</td> </tr> <tr> <td>Seat</td> <td>18 ¼</td> <td>41</td> <td>18</td> </tr> <tr> <td>Arm</td> <td></td> <td></td> <td>27 ½</td> </tr> </tbody> </table>	Dimensions	D	W	H	Overall	26	43 ½	34 ½	Seat	18 ¼	41	18	Arm			27 ½	COM \$1,581 A \$1,601 B \$1,640 COL/C \$1,709 D \$1,796 E \$1,884 F \$1,978 G \$2,109 H \$2,250 I \$2,470 J \$2,734 L1 \$2,205 L2 \$2,364
		Dimensions	D	W	H														
Overall	26	43 ½	34 ½																
Seat	18 ¼	41	18																
Arm			27 ½																
<table border="1"> <thead> <tr> <th>Upholstery</th> <th colspan="3">Shipping</th> </tr> </thead> <tbody> <tr> <td>COM Ydg</td> <td>2 ¼</td> <td>Ctn Wt</td> <td>51</td> </tr> <tr> <td>COL Sq Ft</td> <td>45</td> <td>Cu Ft</td> <td>30</td> </tr> </tbody> </table>	Upholstery	Shipping			COM Ydg	2 ¼	Ctn Wt	51	COL Sq Ft	45	Cu Ft	30							
Upholstery	Shipping																		
COM Ydg	2 ¼	Ctn Wt	51																
COL Sq Ft	45	Cu Ft	30																
Guest Chair 	LA1281 · optional anti-microbial arm cap - add \$122 list	<table border="1"> <thead> <tr> <th>Dimensions</th> <th>D</th> <th>W</th> <th>H</th> </tr> </thead> <tbody> <tr> <td>Overall</td> <td>26</td> <td>22 ½</td> <td>34 ½</td> </tr> <tr> <td>Seat</td> <td>18 ¼</td> <td>20</td> <td>18</td> </tr> <tr> <td>Arm</td> <td></td> <td></td> <td>27 ½</td> </tr> </tbody> </table>	Dimensions	D	W	H	Overall	26	22 ½	34 ½	Seat	18 ¼	20	18	Arm			27 ½	COM \$741 A \$754 B \$781 COL/C \$826 D \$885 E \$943 F \$1,005 G \$1,094 H \$1,187 I \$1,334 J \$1,509 L1 \$1,110 L2 \$1,205
		Dimensions	D	W	H														
Overall	26	22 ½	34 ½																
Seat	18 ¼	20	18																
Arm			27 ½																
<table border="1"> <thead> <tr> <th>Upholstery</th> <th colspan="3">Shipping</th> </tr> </thead> <tbody> <tr> <td>COM Ydg</td> <td>1 ½</td> <td>Ctn Wt</td> <td>22</td> </tr> <tr> <td>COL Sq Ft</td> <td>27</td> <td>Cu Ft</td> <td>15</td> </tr> </tbody> </table>	Upholstery	Shipping			COM Ydg	1 ½	Ctn Wt	22	COL Sq Ft	27	Cu Ft	15							
Upholstery	Shipping																		
COM Ydg	1 ½	Ctn Wt	22																
COL Sq Ft	27	Cu Ft	15																
Loveseat 	LA1282 · optional anti-microbial arm cap - add \$122 list	<table border="1"> <thead> <tr> <th>Dimensions</th> <th>D</th> <th>W</th> <th>H</th> </tr> </thead> <tbody> <tr> <td>Overall</td> <td>26</td> <td>43 ½</td> <td>34 ½</td> </tr> <tr> <td>Seat</td> <td>18 ¼</td> <td>41</td> <td>18</td> </tr> <tr> <td>Arm</td> <td></td> <td></td> <td>27 ½</td> </tr> </tbody> </table>	Dimensions	D	W	H	Overall	26	43 ½	34 ½	Seat	18 ¼	41	18	Arm			27 ½	COM \$1,284 A \$1,304 B \$1,342 COL/C \$1,412 D \$1,499 E \$1,587 F \$1,680 G \$1,812 H \$1,952 I \$2,173 J \$2,436 L1 \$1,908 L2 \$2,067
		Dimensions	D	W	H														
Overall	26	43 ½	34 ½																
Seat	18 ¼	41	18																
Arm			27 ½																
<table border="1"> <thead> <tr> <th>Upholstery</th> <th colspan="3">Shipping</th> </tr> </thead> <tbody> <tr> <td>COM Ydg</td> <td>2 ¼</td> <td>Ctn Wt</td> <td>46</td> </tr> <tr> <td>COL Sq Ft</td> <td>45</td> <td>Cu Ft</td> <td>30</td> </tr> </tbody> </table>	Upholstery	Shipping			COM Ydg	2 ¼	Ctn Wt	46	COL Sq Ft	45	Cu Ft	30							
Upholstery	Shipping																		
COM Ydg	2 ¼	Ctn Wt	46																
COL Sq Ft	45	Cu Ft	30																

GUEST

Description	Model	Specifications			List Price Per Grade	
		Dimensions	D	W		H
Guest Chair 	LA1301 • optional anti-microbial arm cap - add \$122 list • full back • no exposed wood rails	Overall	26	22 ½	34 ½	COM \$744
		Seat	18 ¼	20	18	A \$760
		Arm			27 ½	B \$790
		Upholstery		Shipping		COL/C \$844
		COM Ydg	1 ¾	Ctn Wt	22	D \$912
		COL Sq Ft	32	Cu Ft	15	E \$980
						F \$1,053
						G \$1,154
						H \$1,265
						I \$1,436
						J \$1,641
						L1 \$1,175
						L2 \$1,285

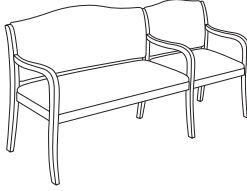
Description	Model	Specifications			List Price Per Grade	
		Dimensions	D	W		H
Loveseat/Chair Unit 	LA1283 • sequence facing unit • optional anti-microbial arm cap - add \$183 list	Overall	26	64 ½	34 ½	COM \$1,876
		Seat	18 ¼	41/20	18	A \$1,909
		Arm			27 ½	B \$1,974
		Upholstery		Shipping		COL/C \$2,088
		COM Ydg	3 ¾	Ctn Wt	64	D \$2,235
		COL Sq Ft	75	Cu Ft	44	E \$2,382
						F \$2,536
						G \$2,756
						H \$2,991
						I \$3,357
						J \$3,797
						L1 \$2,917
						L2 \$3,181

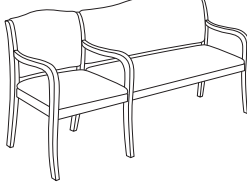
Description	Model	Specifications			List Price Per Grade	
		Dimensions	D	W		H
Chair Unit/Loveseat 	LA1284 • sequence facing unit • optional anti-microbial arm cap - add \$183 list	Overall	26	64 ½	34 ½	COM \$1,876
		Seat	18 ¼	20/41	18	A \$1,909
		Arm			27 ½	B \$1,974
		Upholstery		Shipping		COL/C \$2,088
		COM Ydg	3 ¾	Ctn Wt	64	D \$2,235
		COL Sq Ft	75	Cu Ft	44	E \$2,382
						F \$2,536
						G \$2,756
						H \$2,991
						I \$3,357
						J \$3,797
						L1 \$2,917
						L2 \$3,181

To Order, Specify:

- Model Number
- Wood Species - Beech (B) (chairs)
- Wood Finish
- Fabric Selection - vendor, pattern and color
- Optional Anti-Microbial Arm Cap - add \$61 list per arm cap
- Optional Rubber Cushion Nylon Glides - no upcharge; chairs only

Wood Finish Options:

ALE Ale*	FLX Flax
AUB Auburn*	CGR Graphite Coordinate
AUT Autumn*	CHL High Line Coordinate*
BRL Barley*	CKC Khaki Coordinate
CBE Blonde Echo Coordinate*	LGC Legacy*
BBN Bourbon*	MCH Mocha*
CBZ Brazilwood Coordinate*	NTO Night Owl*
BRG Brighton*	PRL Praline*
BUT Butterscotch	SAF Saffron*
CIN Cinnamon*	SIE Sienna*
CLA Classic*	CST Studio Teak Coordinate*
CCF Coffee Coordinate	TOF Toffee*
CCR Cremello Coordinate	TRF Truffle*
EAR Earthy	VEN Venetian*
ESP Espresso	CWH Walnut Heights Coordinate*

Specifications

- Wood species - Beech (chairs).
- Seat has synthetic sheet webbing and 2" high density polyurethane foam.
- Back has polypropylene webbing and 1 ½" polyurethane foam.
- Mortise and tenon construction with corner blocks, glue and screws.
- Solid one piece steam bent arms with front leg assembly.
- Standard with rubber cushion metal glides.

When ordering Quickship products, place a "Q" in front of model number.
 Example: QGT4901D

Need it.
 JSI Quickship

- See a selection of graded in fabric manufacturers and patterns on pages 12-20. Contact Customer Service for additional fabric options.

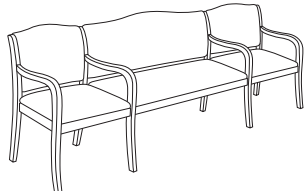
Description	① Model	Specifications				List Price Per Grade
		Dimensions	D	W	H	
Chair/Loveseat/Chair Unit 	LA1285 · optional anti-microbial arm cap - add \$244 list	Overall	26	85 ¾	34 ½	COM \$2,465
		Seat	18 ¼	20/41/20	18	A \$2,511
		Arm			27 ½	B \$2,602
		Upholstery		Shipping		COL/C \$2,762
		COM Ydg	5 ¼	Ctn Wt	82	D \$2,968
		COL Sq Ft	105	Cu Ft	58	E \$3,173
						F \$3,389
						G \$3,696
						H \$4,025
						I \$4,539
						J \$5,154
						L1 \$3,922
						L2 \$4,292

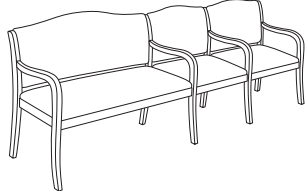
Description	① Model	Specifications				List Price Per Grade
		Dimensions	D	W	H	
Loveseat/Chair/Chair Unit 	LA1286 · sequence facing unit · optional anti-microbial arm cap - add \$244 list	Overall	26	85 ¾	34 ½	COM \$2,465
		Seat	18 ¼	41/20/20	18	A \$2,511
		Arm			27 ½	B \$2,602
		Upholstery		Shipping		COL/C \$2,762
		COM Ydg	5 ¼	Ctn Wt	82	D \$2,968
		COL Sq Ft	105	Cu Ft	58	E \$3,173
						F \$3,389
						G \$3,696
						H \$4,025
						I \$4,539
						J \$5,154
						L1 \$3,922
						L2 \$4,292

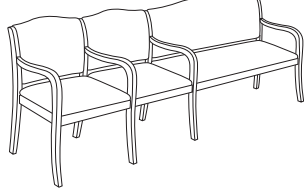
Description	① Model	Specifications				List Price Per Grade
		Dimensions	D	W	H	
Chair/Chair/Loveseat Unit 	LA1287 · sequence facing unit · optional anti-microbial arm cap - add \$244 list	Overall	26	85 ¾	34 ½	COM \$2,465
		Seat	18 ¼	20/20/41	18	A \$2,511
		Arm			27 ½	B \$2,602
		Upholstery		Shipping		COL/C \$2,762
		COM Ydg	5 ¼	Ctn Wt	82	D \$2,968
		COL Sq Ft	105	Cu Ft	58	E \$3,173
						F \$3,389
						G \$3,696
						H \$4,025
						I \$4,539
						J \$5,154
						L1 \$3,922
						L2 \$4,292

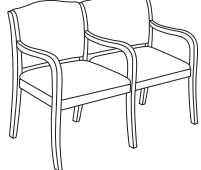
Description	① Model	Specifications				List Price Per Grade
		Dimensions	D	W	H	
Two Seat Unit 	LA1292 · optional anti-microbial arm cap - add \$183 list	Overall	26	43 ½	34 ½	COM \$1,333
		Seat	18 ¼	20	18	A \$1,359
		Arm			27 ½	B \$1,412
		Upholstery		Shipping		COL/C \$1,503
		COM Ydg	3	Ctn Wt	42	D \$1,621
		COL Sq Ft	54	Cu Ft	30	E \$1,737
						F \$1,861
						G \$2,037
						H \$2,224
						I \$2,518
						J \$2,870
						L1 \$2,072
						L2 \$2,260

GUEST

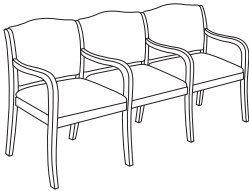
Description	Model	Specifications			List Price Per Grade		
		Dimensions	D	W	H	COM	
Three Seat Unit 	LA1293 • optional anti-microbial arm cap - add \$244 list	Overall	26	64 7/8	34 1/2	COM	\$1,923
		Seat	18 1/4	20	18	A	\$1,963
		Arm			27 1/2	B	\$2,041
		Upholstery		Shipping		COL/C	\$2,178
		COM Ydg	4 1/2	Ctn Wt	60	D	\$2,354
		COL Sq Ft	81	Cu Ft	44	E	\$2,530
						F	\$2,716
						G	\$2,979
						H	\$3,261
						I	\$3,701
				J	\$4,228		
				L1	\$3,032		
				L2	\$3,313		

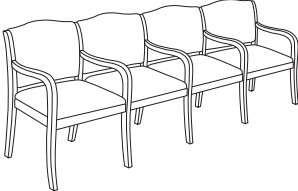
Description	Model	Specifications			List Price Per Grade		
		Dimensions	D	W	H	COM	
Four Seat Unit 	LA1294 • optional anti-microbial arm cap - add \$305 list	Overall	26	86 1/8	34 1/2	COM	\$2,512
		Seat	18 1/4	20	18	A	\$2,565
		Arm			27 1/2	B	\$2,670
		Upholstery		Shipping		COL/C	\$2,851
		COM Ydg	6	Ctn Wt	78	D	\$3,086
		COL Sq Ft	108	Cu Ft	58	E	\$3,321
						F	\$3,568
						G	\$3,920
						H	\$4,295
						I	\$4,882
				J	\$5,585		
				L1	\$3,990		
				L2	\$4,365		

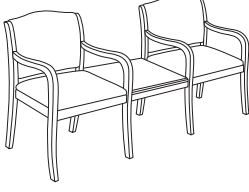
Description	Model	Specifications			List Price Per Grade		
		Dimensions	D	W	H	COM	
Chair/Table/Chair Unit 	LA1295 • optional anti-microbial arm cap - add \$244 list • table - optional coordinating wood grain laminate - no upcharge	Overall	26	64 1/2	34 1/2	COM	\$1,795
		Seat	18 1/4	20	18	A	\$1,821
		Arm			27 1/2	B	\$1,874
		Upholstery		Shipping		COL/C	\$1,965
		COM Ydg	3	Ctn Wt	58	D	\$2,083
		COL Sq Ft	54	Cu Ft	44	E	\$2,199
						F	\$2,323
						G	\$2,499
						H	\$2,686
						I	\$2,980
				J	\$3,332		
				L1	\$2,534		
				L2	\$2,722		

To Order, Specify:

- 1 Model Number
- 2 Wood Species - Beech (B) (chairs)
- 3 Wood Finish
- 4 Fabric Selection - vendor, pattern and color
- 5 Optional Anti-Microbial Arm Cap - add \$61 list per arm cap
- 6 Optional Rubber Cushion Nylon Glides - no upcharge; chairs only
- 7 Optional Coordinating Wood Grain Laminate
Table Tops - no upcharge; tables only. Finishes with an asterisk have a coordinating laminate available.

3 Wood Finish Options:

ALE Ale*	FLX Flax
AUB Auburn*	CGR Graphite Coordinate
AUT Autumn*	CHL High Line Coordinate*
BRL Barley*	CKC Khaki Coordinate
CBE Blonde Echo Coordinate*	LGC Legacy*
BBN Bourbon*	MCH Mocha*
CBZ Brazilwood Coordinate*	NTO Night Owl*
BRG Brighton*	PRL Praline*
BUT Butterscotch	SAF Saffron*
CIN Cinnamon*	SIE Sienna*
CLA Classic*	CST Studio Teak Coordinate*
CCF Coffee Coordinate	TOF Toffee*
CCR Cremello Coordinate	TRF Truffle*
EAR Earthy	VEN Venetian*
ESP Espresso	CWH Walnut Heights Coordinate*

- 4 See a selection of graded fabric manufacturers and patterns on pages 12-20. Contact Customer Service for additional fabric options.

Specifications

- Wood species - Beech (chairs).
- Seat has synthetic sheet webbing and 2" high density polyurethane foam.
- Back has polypropylene webbing and 1 1/2" polyurethane foam.
- Mortise and tenon construction with corner blocks, glue and screws.
- Solid one piece steam bent arms with front leg assembly.
- Standard with rubber cushion metal glides.

Description	D	W	H	CTN WT	CU FT	① Model	List Price
End Table	24	24	17	25	4	LA2424ET	\$637

NOW!

- maple veneer top
- ships KD

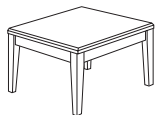

End Table	30	30	17	40	6	LA3030ET	\$746
-----------	----	----	----	----	---	----------	-------

NOW!

- maple veneer top
- ships KD

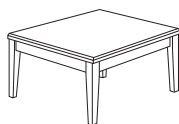

Magazine Table	20	42	17	45	6	LA2042MT	\$753
----------------	----	----	----	----	---	----------	-------

NOW!

- maple veneer top
- ships KD

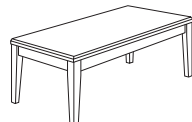

Corner Table	36	36	17	50	8	LA3636CT	\$878
--------------	----	----	----	----	---	----------	-------

NOW!

- maple veneer top
- ships KD



To Order, Specify:

- ① Model Number
- ② Wood Species - Maple (M)
- ③ Wood Finish
- ④ Optional Coordinating Wood Grain Laminate
Table Tops - no upcharge; tables only. Finishes with an asterisk have a coordinating laminate available.

③ Wood Finish Options:

ALE Ale*	FLX Flax
AUB Auburn*	CGR Graphite Coordinate
AUT Autumn*	CHL High Line Coordinate*
BRL Barley*	CKC Khaki Coordinate
CBE Blonde Echo Coordinate*	LGC Legacy*
BBN Bourbon*	MCH Mocha*
CBZ Brazilwood Coordinate*	NTO Night Owl*
BRG Brighton*	PRL Praline*
BUT Butterscotch	SAF Saffron*
CIN Cinnamon*	SIE Sienna*
CLA Classic*	CST Studio Teak Coordinate*
CCF Coffee Coordinate	TOF Toffee*
CCR Cremello Coordinate	TRF Truffle*
EAR Earthy	VEN Venetian*
ESP Espresso	CWH Walnut Heights Coordinate*

Specifications

- Wood species - Maple veneer (tables).
- Top core material is 1 1/8" thick with 45 lb. density industrial grade particle board.
- Face is wood veneer or .050 horizontal grade HPL.
- Backer is bonded to bottom side to ensure balanced construction.
- All tops have internal solid lumber bands with overlay laminate or veneer.

When ordering Quickship products, place a "Q" in front of model number.
Example: QGT4901D

NOW!
Need it.
JSI Quickship

Madison Order Check List:



Specify:

- 1. Model Number
- 2. Wood Species - Maple (M)
- 3. Wood Leg/Arm Detail Finish
- 4. Fabric Selection - vendor, pattern and color
- 5. Optional Black Antique Trim Nails - no upcharge
(Replaces standard antique brass trim nails)
- 6. Optional Casters - add \$92 list; specify color
- 7. Optional Rubber Cushion Nylon Glides - no upcharge

Example:

MA1501F (model #)	M (wood species)	AUB (finish) wood leg/arm detail	MOMENTUM (fabric vendor)	VOX (pattern name)	MYSTIC (pattern color)
-----------------------------	----------------------------	---	------------------------------------	------------------------------	----------------------------------

1. Model Number

2. Wood Species - Maple (M)

3. Wood Leg/Arm Detail Finish Options:

ALE Ale	FLX Flax
AUB Auburn	CGR Graphite Coordinate
AUT Autumn	CHL High Line Coordinate
BRL Barley	CKC Khaki Coordinate
CBE Blonde Echo Coordinate	LGC Legacy
BBN Bourbon	MCH Mocha
CBZ Brazilwood Coordinate	NTO Night Owl
BRG Brighton	PRL Praline
BUT Butterscotch	SAF Saffron
CIN Cinnamon	SIE Sienna
CLA Classic	CST Studio Teak Coordinate
CCF Coffee Coordinate	TOF Toffee
CCR Cremello Coordinate	TRF Truffle
EAR Earthy	VEN Venetian
ESP Espresso	CWH Walnut Heights Coordinate

4. Fabric Selection - Please supply the following:

- Fabric vendor
- Pattern name
- Pattern color

When specifying contrasting upholstery, indicate clearly which upholstery is to be applied to the seat, back and arms. Use higher grade pricing.

- Indicate direction of fabric - Railroaded or Up the Roll
- Please provide illustration, if available

All COM orders must include the following:

- Vendor's name, pattern name and color
- Sample of the fabric attached to order
- Model numbers of items for fabric application

- Special application instructions (e.g., all stripes will be applied front to back unless specified otherwise)
- Customer and purchase order number

Ship prepaid COM material to:
JSI
 Attn: COM Dept
 932 Mill Street
 Jasper, IN 47546

Application of fabric:
 Railroaded Up the Roll

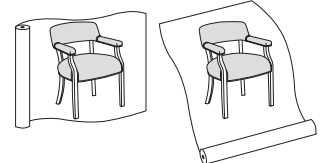

All COM orders will ship at standard lead time from receipt of COM except for orders requiring special custom matched finishes.

5. Optional Black Antique Trim Nails - no upcharge
(Replaces standard antique brass trim nails)

6. Optional Casters - add \$92 list; specify color.

- Color:**
- Black
 - Antique Brass

7. Optional Rubber Cushion Nylon Glides - no upcharge

For Madison Swivel Seating, see page 41.

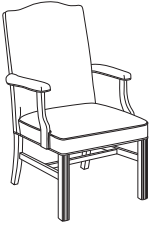
Description	① Model	Specifications			List Price Per Grade	
Guest Chair 	MA1501F · plain seat and back · upholstered arm cap	Dimensions	D	W	H	COM \$796
		Overall	27 ½	26 ½	40 ½	A \$818
		Seat	18 ½	21	18 ¾	B \$863
		Arm			25 ½	COL/C \$938
		Upholstery	Shipping			D \$1,036
		COM Ydg	2 ½	Ctn Wt	37	E \$1,133
		COL Sq Ft	45	Cu Ft	15	F \$1,236
						G \$1,383
						H \$1,540
						I \$1,784
						J \$2,077
						L1 \$1,413
						L2 \$1,569

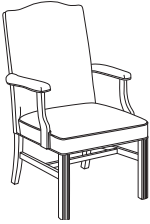
Description	① Model	Specifications			List Price Per Grade	
Guest Chair with Trim Nails 	MA1501J · plain seat and back · upholstered arm cap · Antique Brass trim nails	Dimensions	D	W	H	COM \$899
		Overall	27 ½	26 ½	40 ½	A \$921
		Seat	18 ½	21	18 ¾	B \$965
		Arm			25 ½	COL/C \$1,041
		Upholstery	Shipping			D \$1,139
		COM Ydg	2 ½	Ctn Wt	37	E \$1,236
		COL Sq Ft	45	Cu Ft	15	F \$1,339
						G \$1,486
						H \$1,643
						I \$1,887
						J \$2,180
						L1 \$1,516
						L2 \$1,672

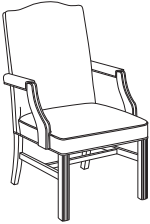
Description	① Model	Specifications			List Price Per Grade	
Guest Chair 	MA1531F · plain seat and back · upholstered arm rest	Dimensions	D	W	H	COM \$915
		Overall	27 ½	26 ½	40 ½	A \$937
		Seat	18 ½	21	18 ¾	B \$981
		Arm			25 ½	COL/C \$1,057
		Upholstery	Shipping			D \$1,154
		COM Ydg	2 ½	Ctn Wt	37	E \$1,252
		COL Sq Ft	45	Cu Ft	15	F \$1,355
						G \$1,502
						H \$1,658
						I \$1,903
						J \$2,196
						L1 \$1,531
						L2 \$1,688

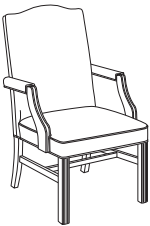
Description	① Model	Specifications			List Price Per Grade	
Guest Chair with Trim Nails 	MA1531J · plain seat and back · upholstered arm rest · Antique Brass trim nails	Dimensions	D	W	H	COM \$1,018
		Overall	27 ½	26 ½	40 ½	A \$1,040
		Seat	18 ½	21	18 ¾	B \$1,084
		Arm			25 ½	COL/C \$1,160
		Upholstery	Shipping			D \$1,257
		COM Ydg	2 ½	Ctn Wt	37	E \$1,355
		COL Sq Ft	45	Cu Ft	15	F \$1,458
						G \$1,605
						H \$1,761
						I \$2,006
						J \$2,299
						L1 \$1,634
						L2 \$1,791

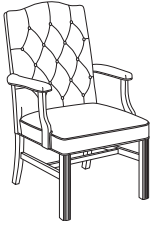
Description	Model	Specifications				List Price Per Grade	
Guest Chair 	MA1501G · fold tufted back · plain seat · upholstered arm cap	Dimensions		D	W	H	COM \$915
		Overall	27 1/2	26 1/2	40 1/2	A \$941	
		Seat	18 1/2	21	18 3/4	B \$994	
		Arm			25 1/2	COL/C \$1,085	
		Upholstery		Shipping		D \$1,203	
		COM Ydg	3	Ctn Wt	37	E \$1,319	
		COL Sq Ft	54	Cu Ft	15	F \$1,443	
						G \$1,620	
						H \$1,806	
						I \$2,100	
				J \$2,452			
				L1 \$1,654			
				L2 \$1,842			

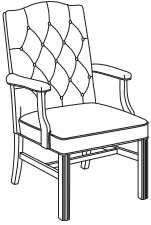
Description	Model	Specifications				List Price Per Grade	
Guest Chair with Trim Nails 	MA1501K · fold tufted back · plain seat · upholstered arm cap · Antique Brass trim nails	Dimensions		D	W	H	COM \$1,006
		Overall	27 1/2	26 1/2	40 1/2	A \$1,033	
		Seat	18 1/2	21	18 3/4	B \$1,085	
		Arm			25 1/2	COL/C \$1,176	
		Upholstery		Shipping		D \$1,294	
		COM Ydg	3	Ctn Wt	37	E \$1,411	
		COL Sq Ft	54	Cu Ft	15	F \$1,535	
						G \$1,711	
						H \$1,898	
						I \$2,192	
				J \$2,544			
				L1 \$1,746			
				L2 \$1,934			

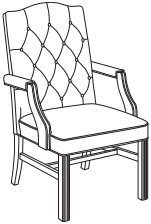
Description	Model	Specifications				List Price Per Grade	
Guest Chair 	MA1531G · fold tufted back · plain seat · upholstered arm rest	Dimensions		D	W	H	COM \$1,034
		Overall	27 1/2	26 1/2	40 1/2	A \$1,060	
		Seat	18 1/2	21	18 3/4	B \$1,112	
		Arm			25 1/2	COL/C \$1,204	
		Upholstery		Shipping		D \$1,321	
		COM Ydg	3	Ctn Wt	37	E \$1,438	
		COL Sq Ft	54	Cu Ft	15	F \$1,562	
						G \$1,738	
						H \$1,925	
						I \$2,219	
				J \$2,571			
				L1 \$1,773			
				L2 \$1,961			

To Order, Specify:

- 1 Model Number
- 2 Wood Species - Maple (M)
- 3 Wood Leg/Arm Detail Finish
- 4 Fabric Selection - vendor, pattern and color
- 5 Optional black antique trim nails - no upcharge (Replaces standard antique brass trim nails)
- 6 Optional Casters - add \$92 list; specify color
- 7 Optional Rubber Cushion Nylon Glides - no upcharge

3 Wood Leg/Arm Detail Finish Options:

ALE Ale	FLX Flax
AUB Auburn	CGR Graphite Coordinate
AUT Autumn	CHL High Line Coordinate
BRL Barley	CKC Khaki Coordinate
CBE Blonde Echo Coordinate	LGC Legacy
BBN Bourbon	MCH Mocha
CBZ Brazilwood Coordinate	NTO Night Owl
BRG Brighton	PRL Praline
BUT Butterscotch	SAF Saffron
CIN Cinnamon	SIE Sienna
CLA Classic	CST Studio Teak Coordinate
CCF Coffee Coordinate	TOF Toffee
CCR Cremello Coordinate	TRF Truffle
EAR Earthy	VEN Venetian
ESP Espresso	CWH Walnut Heights Coordinate

Specifications

- Wood species - Maple.
- Seat has synthetic sheet webbing and 3" polyurethane foam.
- Back has polypropylene webbing and 2" polyurethane foam.
- Arms have 1 1/2" polyurethane foam.
- Mortise and tenon construction with corner blocks, glue and screws.
- Standard with rubber cushion metal glides.

- 4 See a selection of graded in fabric manufacturers and patterns on pages 12-20. Contact Customer Service for additional fabric options.

When ordering Quickship products, place a "Q" in front of model number. Example: QGT4901D

NOW!
Need it.
JSI Quickship

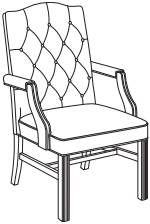
Description	① Model	Specifications				List Price Per Grade	
Guest Chair with Trim Nails 	MA1531K · fold tufted back · plain seat · upholstered arm rest · Antique Brass trim nails	Dimensions		D	W	H	COM \$1,125 A \$1,151 B \$1,204 COL/C \$1,295 D \$1,413 E \$1,529 F \$1,653 G \$1,830 H \$2,016 I \$2,310 J \$2,662 L1 \$1,864 L2 \$2,052
		Overall	27 ½	26 ½	40 ½		
		Seat	18 ½	21	18 ¾		
		Arm			25 ½		
		Upholstery		Shipping			
		COM Ydg	3	Ctn Wt	37		
		COL Sq Ft	54	Cu Ft	15		

Description	① Model	Specifications				List Price Per Grade	
Guest Chair 	MA1533F · plain seat and back · armless	Dimensions		D	W	H	COM \$764 A \$780 B \$810 COL/C \$864 D \$932 E \$1,000 F \$1,073 G \$1,174 H \$1,285 I \$1,456 J \$1,661 L1 \$1,195 L2 \$1,305
		Overall	27 ½	20 ½ ▲	40 ½		
		Seat	18 ½	21	18 ¾		
		Upholstery		Shipping			
		COM Ydg	2 ½	Ctn Wt	34		
		COL Sq Ft	50	Cu Ft	15		

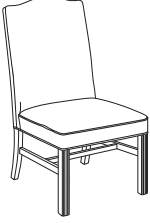
Description	① Model	Specifications				List Price Per Grade	
Guest Chair with Trim Nails 	MA1533J · plain seat and back · armless · Antique Brass trim nails	Dimensions		D	W	H	COM \$867 A \$882 B \$913 COL/C \$966 D \$1,035 E \$1,103 F \$1,175 G \$1,277 H \$1,388 I \$1,559 J \$1,763 L1 \$1,298 L2 \$1,407
		Overall	27 ½	20 ½ ▲	40 ½		
		Seat	18 ½	21	18 ¾		
		Upholstery		Shipping			
		COM Ydg	2 ½	Ctn Wt	34		
		COL Sq Ft	50	Cu Ft	15		

Description	① Model	Specifications				List Price Per Grade	
Guest Chair 	MA1533G · fold tufted back · plain seat · armless	Dimensions		D	W	H	COM \$882 A \$902 B \$941 COL/C \$1,011 D \$1,099 E \$1,186 F \$1,279 G \$1,411 H \$1,551 I \$1,772 J \$2,035 L1 \$1,437 L2 \$1,578
		Overall	27 ½	20 ½ ▲	40 ½		
		Seat	18 ½	21	18 ¾		
		Upholstery		Shipping			
		COM Ydg	3	Ctn Wt	34		
		COL Sq Ft	60	Cu Ft	15		

GUEST

Description	Model	Specifications			List Price Per Grade	
Guest Chair with Trim Nails 	MA1533K · fold tufted back · plain seat · armless · Antique Brass trim nails	Dimensions	D	W	H	COM \$974
		Overall	27 1/2	20 1/2	40 1/2	A \$994
		Seat	18 1/2	21	18 3/4	B \$1,033
		Upholstery	Shipping			COL/C \$1,102
		COM Ydg	3	Ctn Wt	34	D \$1,190
		COL Sq Ft	60	Cu Ft	15	E \$1,277
						F \$1,371
						G \$1,502
						H \$1,643
						I \$1,863
						J \$2,127
						L1 \$1,528
						L2 \$1,669

Description	Model	Specifications			List Price Per Grade	
Guest Chair 	MA1561F · plain seat and back	Dimensions	D	W	H	COM \$612
		Overall	25 1/4	24 1/2	30	A \$629
		Seat	20 1/4	18 1/4	19	B \$664
		Arm			25	COL/C \$725
		Upholstery	Shipping			D \$804
		COM Ydg	2	Ctn Wt	32	E \$881
		COL Sq Ft	36	Cu Ft	14	F \$964
						G \$1,081
						H \$1,206
						I \$1,402
						J \$1,636
						L1 \$1,105
						L2 \$1,230

Description	Model	Specifications			List Price Per Grade	
Guest Chair with Trim Nails 	MA1561J · plain seat and back · Antique Brass trim nails	Dimensions	D	W	H	COM \$665
		Overall	25 1/4	24 1/2	30	A \$683
		Seat	20 1/4	18 1/4	19	B \$718
		Arm			25	COL/C \$779
		Upholstery	Shipping			D \$857
		COM Ydg	2	Ctn Wt	32	E \$935
		COL Sq Ft	36	Cu Ft	14	F \$1,018
						G \$1,134
						H \$1,259
						I \$1,456
						J \$1,690
						L1 \$1,159
						L2 \$1,284

To Order, Specify:

- Model Number
- Wood Species - Maple (M)
- Wood Leg/Arm Detail Finish
- Fabric Selection - vendor, pattern and color
- Optional black antique trim nails - no upcharge (Replaces standard antique brass trim nails)
- Optional Casters - add \$92 list; specify color
- Optional Rubber Cushion Nylon Glides - no upcharge

Wood Leg/Arm Detail Finish Options:

ALE Ale	FLX Flax
AUB Auburn	CGR Graphite Coordinate
AUT Autumn	CHL High Line Coordinate
BRL Barley	CKC Khaki Coordinate
CBE Blonde Echo Coordinate	LGC Legacy
BBN Bourbon	MCH Mocha
CBZ Brazilwood Coordinate	NTO Night Owl
BRG Brighton	PRL Praline
BUT Butterscotch	SAF Saffron
CIN Cinnamon	SIE Sienna
CLA Classic	CST Studio Teak Coordinate
CCF Coffee Coordinate	TOF Toffee
CCR Cremello Coordinate	TRF Truffle
EAR Earthy	VEN Venetian
ESP Espresso	CWH Walnut Heights Coordinate

Specifications

- Wood species - Maple.
- Seat has synthetic sheet webbing and 3" polyurethane foam.
- Back has polypropylene webbing and 2" polyurethane foam.
- Arms have 1 1/2" polyurethane foam.
- Mortise and tenon construction with corner blocks, glue and screws.
- Standard with rubber cushion metal glides.

When ordering Quickship products, place a "Q" in front of model number.
 Example: QGT4901D

NOW!
 Need it.
 JSI Quickship

- See a selection of graded in fabric manufacturers and patterns on pages 12-20. Contact Customer Service for additional fabric options.

Description	1 Model	Specifications			List Price Per Grade	
Guest Chair 	MA1563F · plain seat and back · Antique Brass casters	Dimensions	D	W	H	COM \$713
		Overall	25 ¼	24 ½	30	A \$731
		Seat	20 ¼	18 ¼	19	B \$766
		Arm			25	COL/C \$827
		Upholstery		Shipping		D \$906
		COM Ydg	2	Ctn Wt	34	E \$983
		COL Sq Ft	36	Cu Ft	14	F \$1,066
						G \$1,183
						H \$1,308
						I \$1,504

Description	1 Model	Specifications			List Price Per Grade	
Guest Chair with Trim Nails 	MA1563J · plain seat and back · Antique Brass casters · Antique Brass trim nails	Dimensions	D	W	H	COM \$767
		Overall	25 ¼	24 ½	30	A \$785
		Seat	20 ¼	18 ¼	19	B \$819
		Arm			25	COL/C \$880
		Upholstery		Shipping		D \$959
		COM Ydg	2	Ctn Wt	34	E \$1,037
		COL Sq Ft	36	Cu Ft	14	F \$1,120
						G \$1,236
						H \$1,361
						I \$1,558

GUEST

To Order, Specify:

- 1 Model Number
- 2 Wood Species - Maple (M)
- 3 Wood Leg/Arm Detail Finish
- 4 Fabric Selection - vendor, pattern and color
- 5 Optional black antique trim nails - no upcharge (Replaces standard antique brass trim nails)
- 6 Optional Casters - add \$92 list; specify color
- 7 Optional Rubber Cushion Nylon Glides - no upcharge

3 Wood Leg/Arm Detail Finish Options:

ALE Ale	FLX Flax
AUB Auburn	CGR Graphite Coordinate
AUT Autumn	CHL High Line Coordinate
BRL Barley	CKC Khaki Coordinate
CBE Blonde Echo Coordinate	LGC Legacy
BBN Bourbon	MCH Mocha
CBZ Brazilwood Coordinate	NTO Night Owl
BRG Brighton	PRL Praline
BUT Butterscotch	SAF Saffron
CIN Cinnamon	SIE Sienna
CLA Classic	CST Studio Teak Coordinate
CCF Coffee Coordinate	TOF Toffee
CCR Cremello Coordinate	TRF Truffle
EAR Earthy	VEN Venetian
ESP Espresso	CWH Walnut Heights Coordinate

Specifications

- Wood species - Maple.
- Seat has synthetic sheet webbing and 3" polyurethane foam.
- Back has polypropylene webbing and 2" polyurethane foam.
- Arms have 1 ½" polyurethane foam.
- Mortise and tenon construction with corner blocks, glue and screws.
- Standard with rubber cushion metal glides.

When ordering Quickship products, place a "Q" in front of model number.
 Example: QGT4901D



- 4 See a selection of graded in fabric manufacturers and patterns on pages 12-20. Contact Customer Service for additional fabric options.

Portrait Order Check List:



Specify:

- 1. Model Number
- 2. Wood Species - Maple (M)
- 3. Wood Finish
- 4. Fabric Selection - vendor, pattern and color
- 5. Button/Reverse Diamond Detail - add \$139 list

Example:

PO9030 | M | AUB | MOMENTUM | VOX | MYSTIC
 (model #) | (wood species) | (finish) | (fabric vendor) | (pattern name) | (pattern color)

1. Model Number

2. Wood Species - Maple (M)

3. Wood Finish Options:

ALE Ale	FLX Flax
AUB Auburn	CGR Graphite Coordinate
AUT Autumn	CHL High Line Coordinate
BRL Barley	CKC Khaki Coordinate
CBE Blonde Echo Coordinate	LGC Legacy
BBN Bourbon	MCH Mocha
CBZ Brazilwood Coordinate	NTO Night Owl
BRG Brighton	PRL Praline
BUT Butterscotch	SAF Saffron
CIN Cinnamon	SIE Sienna
CLA Classic	CST Studio Teak Coordinate
CCF Coffee Coordinate	TOF Toffee
CCR Cremello Coordinate	TRF Truffle
EAR Earthy	VEN Venetian
ESP Espresso	CWH Walnut Heights Coordinate

4. Fabric Selection - Please supply the following:

- Vendor name
- Pattern name
- Pattern color

When specifying contrasting upholstery, indicate clearly which upholstery is to be applied to the seat and back. Use higher grade pricing.

- Indicate direction of fabric - Railroaded or Up the Roll
- Please provide illustration, if available

All COM orders must include the following:

- Vendor's name, pattern name and color
- Sample of the fabric attached to order
- Model numbers of items for fabric application
- Special application instructions (e.g., all stripes will be applied front to back unless specified otherwise)
- Customer and purchase order number

Ship prepaid COM material to:
 JSI
 Attn: COM Dept
 932 Mill Street
 Jasper, IN 47546

Application of fabric:
 Railroaded Up the Roll

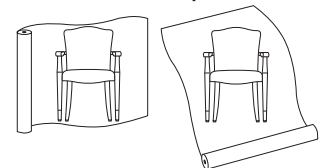

All COM orders will ship at standard lead time from receipt of COM except for orders requiring special custom matched finishes.

5. Button/Reverse Diamond Detail - add \$139 list. Fabric direction on top and bottom sections run with the nap. Side sections run railroad. Ex: stripes run vertical on top and bottom sections and horizontal on side sections.



For Portrait Swivel Seating, see page 48.

For Portrait Lounge Seating, see page 390.

Description	1 Model	Specifications				List Price Per Grade	
Guest Chair 	P09030 · scroll arm · upholstered seat and back	Dimensions		D	W	H	COM \$1,671
		Overall	25 ½	23	35	A \$1,689	
		Seat	17 ½	20	19	B \$1,724	
		Arm			25	COL/C \$1,784	
		Upholstery		Shipping		D \$1,863	
		COM Ydg	2	Ctn Wt	26	E \$1,941	
		COL Sq Ft	36	Cu Ft	14	F \$2,024	
						G \$2,140	
						H \$2,265	
						I \$2,462	
				J \$2,696			
				L1 \$2,165			
				L2 \$2,289			

Description	1 Model	Specifications				List Price Per Grade	
Guest Chair 	P09050 · armless · upholstered seat and back	Dimensions		D	W	H	COM \$1,690
		Overall	25 ½	22 ½	35	A \$1,708	
		Seat	17 ½	20	19	B \$1,742	
		Arm				COL/C \$1,803	
		Upholstery		Shipping		D \$1,882	
		COM Ydg	2	Ctn Wt	26	E \$1,960	
		COL Sq Ft	36	Cu Ft	14	F \$2,043	
						G \$2,159	
						H \$2,284	
						I \$2,481	
				J \$2,715			
				L1 \$2,183			
				L2 \$2,308			

GUEST

To Order, Specify:

- 1 Model Number
- 2 Wood Species - Maple (M)
- 3 Wood Finish
- 4 Fabric Selection - vendor, pattern and color
- 5 Button/Reverse Diamond Detail - add \$139 list

3 Wood Finish Options:

ALE Ale	FLX Flax
AUB Auburn	CGR Graphite Coordinate
AUT Autumn	CHL High Line Coordinate
BRL Barley	CKC Khaki Coordinate
CBE Blonde Echo Coordinate	LGC Legacy
BBN Bourbon	MCH Mocha
CBZ Brazilwood Coordinate	NTO Night Owl
BRG Brighton	PRL Praline
BUT Butterscotch	SAF Saffron
CIN Cinnamon	SIE Sienna
CLA Classic	CST Studio Teak Coordinate
CCF Coffee Coordinate	TOF Toffee
CCR Cremello Coordinate	TRF Truffle
EAR Earthy	VEN Venetian
ESP Espresso	CWH Walnut Heights Coordinate

Specifications

- Wood species - Maple.
- Seat has synthetic sheet webbing with high resiliency seat polyurethane foam and Dacron® wrap.
- Back has polypropylene webbing and polyurethane foam with Dacron® wrap.
- Hardwood interior frame is joined with dowels.

- 4 See a selection of graded in fabric manufacturers and patterns on pages 12-20. Contact Customer Service for additional fabric options.

Profile Order Check List:



Specify:

- 1. Model Number
- 2. Wood Species - Beech (B)
- 3. Wood Finish
- 4. Fabric Selection - vendor, pattern and color
- 5. Optional Rubber Cushion Nylon Glides - no upcharge

Example:

PR6631C | **B** | **AUB** | **MOMENTUM** | **VOX** | **MYSTIC**
 (model #) | (wood species) | (finish) | (fabric vendor) | (pattern name) | (pattern color)

1. Model Number

2. Wood Species - Beech (B)

3. Wood Finish Options:

ALE Ale	FLX Flax
AUB Auburn	CGR Graphite Coordinate
AUT Autumn	CHL High Line Coordinate
BRL Barley	CKC Khaki Coordinate
CBE Blonde Echo Coordinate	LGC Legacy
BBN Bourbon	MCH Mocha
CBZ Brazilwood Coordinate	NTO Night Owl
BRG Brighton	PRL Praline
BUT Butterscotch	SAF Saffron
CIN Cinnamon	SIE Sienna
CLA Classic	CST Studio Teak Coordinate
CCF Coffee Coordinate	TOF Toffee
CCR Cremello Coordinate	TRF Truffle
EAR Earthy	VEN Venetian
ESP Espresso	CWH Walnut Heights Coordinate

4. Fabric Selection - Please supply the following:

- Fabric vendor
- Pattern name
- Pattern color

When specifying contrasting upholstery, indicate clearly which upholstery is to be applied to the seat, back and arms. Use higher grade pricing.

- Indicate direction of fabric - Railroaded or Up the Roll
- Please provide illustration, if available

All COM orders must include the following:

- Vendor's name, pattern name and color
- Sample of the fabric attached to order
- Model numbers of items for fabric application
- Special application instructions (e.g., all stripes will be applied front to back unless specified otherwise)
- Customer and purchase order number

Ship prepaid COM material to:
 JSI
 Attn: COM Dept
 932 Mill Street
 Jasper, IN 47546

Application of fabric:
 Railroaded Up the Roll

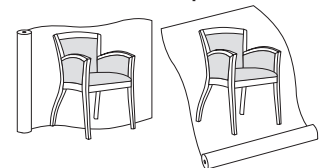

All COM orders will ship at standard lead time from receipt of COM except for orders requiring special custom matched finishes.

5. Optional Rubber Cushion Nylon Glides - no upcharge

Description	1 Model	Specifications			List Price Per Grade	
Guest Chair 	PR66310 · open arm	Dimensions	D	W	H	COM \$758
		Overall	23 ¼	23 ½	33 ¼	A \$771
		Seat	19 ¾	18	20 ¼	B \$797
		Arm			27 ¾	COL/C \$843
		Upholstery	Shipping			D \$901
		COM Ydg	1 ½	Ctn Wt	31	E \$960
		COL Sq Ft	27	Cu Ft	14	F \$1,022
						G \$1,110
						H \$1,204
						I \$1,351
				J \$1,526		
				L1 \$1,127		
				L2 \$1,222		

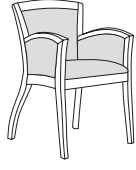
Description	1 Model	Specifications			List Price Per Grade	
Guest Chair 	PR6631C · closed arm	Dimensions	D	W	H	COM \$836
		Overall	23 ¼	23 ½	33 ¼	A \$854
		Seat	19 ¾	18	20 ¼	B \$889
		Arm			27 ¾	COL/C \$950
		Upholstery	Shipping			D \$1,028
		COM Ydg	2	Ctn Wt	31	E \$1,106
		COL Sq Ft	36	Cu Ft	14	F \$1,189
						G \$1,306
						H \$1,431
						I \$1,627
				J \$1,861		
				L1 \$1,330		
				L2 \$1,455		

Description	1 Model	Specifications			List Price Per Grade	
Guest Chair 	PR6631F · fully upholstered	Dimensions	D	W	H	COM \$878
		Overall	23 ¼	23 ½	33 ¼	A \$902
		Seat	19 ¾	18	20 ¼	B \$951
		Arm			27 ¾	COL/C \$1,035
		Upholstery	Shipping			D \$1,142
		COM Ydg	2 ¾	Ctn Wt	31	E \$1,249
		COL Sq Ft	50	Cu Ft	14	F \$1,362
						G \$1,524
						H \$1,696
						I \$1,965
				J \$2,287		
				L1 \$1,557		
				L2 \$1,728		

To Order, Specify:

- 1 Model Number
- 2 Wood Species - Beech (B)
- 3 Wood Finish
- 4 Fabric Selection - vendor, pattern and color
- 5 Optional Rubber Cushion Nylon Glides - no upcharge

3 Wood Finish Options:

ALE Ale	FLX Flax
AUB Auburn	CGR Graphite Coordinate
AUT Autumn	CHL High Line Coordinate
BRL Barley	CKC Khaki Coordinate
CBE Blonde Echo Coordinate	LGC Legacy
BBN Bourbon	MCH Mocha
CBZ Brazilwood Coordinate	NTO Night Owl
BRG Brighton	PRL Praline
BUT Butterscotch	SAF Saffron
CIN Cinnamon	SIE Sienna
CLA Classic	CST Studio Teak Coordinate
CCF Coffee Coordinate	TOF Toffee
CCR Cremello Coordinate	TRF Truffle
EAR Earthy	VEN Venetian
ESP Espresso	CWH Walnut Heights Coordinate

Specifications

- Wood species - Beech.
- Seat has synthetic sheet webbing, one layer of 2" polyurethane foam.
- Back has steam bent back posts and 1" polyurethane foam.
- Closed arms have ½" polyurethane foam.
- Fully upholstered arms have ½" polyurethane foam on sides and ¾" polyurethane foam on top.
- Mortise and tenon construction with corner blocks, glue and screws.
- Standard with rubber cushion metal glides.

When ordering Quickship products, place a "Q" in front of model number. Example: QGT4901D



- 4 See a selection of graded in fabric manufacturers and patterns on pages 12-20. Contact Customer Service for additional fabric options.

Ria Order Check List:



Specify:

- 1. Model Number
- 2. Wood Species - Maple (M)
- 3. Wood Finish
- 4. Fabric Selection - vendor, pattern and color
- 5. Optional Rubber Cushion Nylon Glides - no upcharge

Example:

RI2571 | M | AUB | MOMENTUM | VOX | MYSTIC
 (model #) | (wood species) | (finish) | (fabric vendor) | (pattern name) | (pattern color)

1. Model Number

- Special application instructions (e.g., all stripes will be applied front to back unless specified otherwise)
- Customer and purchase order number

2. Wood Species - Maple (M)

3. Wood Finish Options:

ALE Ale	FLX Flax
AUB Auburn	CGR Graphite Coordinate
AUT Autumn	CHL High Line Coordinate
BRL Barley	CKC Khaki Coordinate
CBE Blonde Echo Coordinate	LGC Legacy
BBN Bourbon	MCH Mocha
CBZ Brazilwood Coordinate	NTO Night Owl
BRG Brighton	PRL Praline
BUT Butterscotch	SAF Saffron
CIN Cinnamon	SIE Sienna
CLA Classic	CST Studio Teak Coordinate
CCF Coffee Coordinate	TOF Toffee
CCR Cremello Coordinate	TRF Truffle
EAR Earthy	VEN Venetian
ESP Espresso	CWH Walnut Heights Coordinate

Ship prepaid COM material to:
 JSI
 Attn: COM Dept
 932 Mill Street
 Jasper, IN 47546

Application of fabric:
 Railroaded Up the Roll

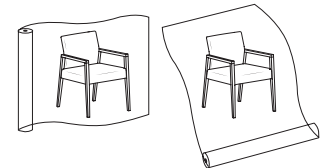

All COM orders will ship at standard lead time from receipt of COM except for orders requiring special custom matched finishes.

4. Fabric Selection - Please supply the following:

- Fabric vendor
- Pattern name
- Pattern color

When specifying contrasting upholstery, indicate clearly which upholstery is to be applied to the seat and back. Use higher grade pricing.

- Indicate direction of fabric - Railroaded or Up the Roll
- Please provide illustration, if available

All COM orders must include the following:

- Vendor's name, pattern name and color
- Sample of the fabric attached to order
- Model numbers of items for fabric application

5. Optional Rubber Cushion Nylon Glides - no upcharge

Description	① Model	Specifications			List Price Per Grade	
		Dimensions	D	W		H
Guest Chair	RI2571	Overall	25	22 ½	31 ½	COM \$768
		Seat	19	20	18 ¼	A \$794
		Arm			25 ½	B \$824
		Upholstery		Shipping		COL/C \$875
		COM Ydg	1 ½	Ctn Wt	20	D \$941
		COL Sq Ft	27	Cu Ft	12	E \$1,007
						F \$1,110
						G \$1,220
						H \$1,337
						I \$1,521
						J \$1,740
						L1 \$1,242
						L2 \$1,359

GUEST

To Order, Specify:

- ① Model Number
- ② Wood Species - Maple (M)
- ③ Wood Finish
- ④ Fabric Selection - vendor, pattern and color
- ⑤ Optional Rubber Cushion Nylon Glides - no upcharge

③ Wood Finish Options:

ALE Ale	FLX Flax
AUB Auburn	CGR Graphite Coordinate
AUT Autumn	CHL High Line Coordinate
BRL Barley	CKK Khaki Coordinate
CBE Blonde Echo Coordinate	LGC Legacy
BBN Bourbon	MCH Mocha
CBZ Brazilwood Coordinate	NTO Night Owl
BRG Brighton	PRL Praline
BUT Butterscotch	SAF Saffron
CIN Cinnamon	SIE Sienna
CLA Classic	CST Studio Teak Coordinate
CCF Coffee Coordinate	TOF Toffee
CCR Cremello Coordinate	TRF Truffle
EAR Earthy	VEN Venetian
ESP Espresso	CWH Walnut Heights Coordinate

Specifications

- Wood species - Maple.
- Solid Maple lumber exterior frame.
- Solid lumber interior frame.
- Seat has synthetic sheet webbing and 2" high density polyurethane foam.
- Back has synthetic sheet webbing and 1 ¼" polyurethane foam.
- Mortise and tenon construction with corner blocks, glue and screws.
- Wall saver feature.
- Standard with rubber cushion metal glides.

- ④ See a selection of graded in fabric manufacturers and patterns on pages 12-20. Contact Customer Service for additional fabric options.

Solara Order Check List:



Specify:

- 1. Model Number
- 2. Wood Species - Maple (M)
- 3. Wood Finish
- 4. Fabric Selection - vendor, pattern and color

Example:

S07335 | **M** | **AUB** | **MOMENTUM** | **VOX** | **MYSTIC**
 (model #) | (wood species) | (finish) | (fabric vendor) | (pattern name) | (pattern color)

1. Model Number

2. Wood Species - Maple (M)

3. Wood Finish Options:

ALE Ale	FLX Flax
AUB Auburn	CGR Graphite Coordinate
AUT Autumn	CHL High Line Coordinate
BRL Barley	CKC Khaki Coordinate
CBE Blonde Echo Coordinate	LGC Legacy
BBN Bourbon	MCH Mocha
CBZ Brazilwood Coordinate	NTO Night Owl
BRG Brighton	PRL Praline
BUT Butterscotch	SAF Saffron
CIN Cinnamon	SIE Sienna
CLA Classic	CST Studio Teak Coordinate
CCF Coffee Coordinate	TOF Toffee
CCR Cremello Coordinate	TRF Truffle
EAR Earthy	VEN Venetian
ESP Espresso	CWH Walnut Heights Coordinate

4. Fabric Selection - Please supply the following:

- Fabric vendor
- Pattern name
- Pattern color

When specifying contrasting upholstery, indicate clearly which upholstery is to be applied to the seat and back. Use higher grade pricing.

- Indicate direction of fabric - Railroaded or Up the Roll
- Please provide illustration, if available

All COM orders must include the following:

- Vendor's name, pattern name and color
- Sample of the fabric attached to order
- Model numbers of items for fabric application
- Special application instructions (e.g., all stripes will be applied front to back unless specified otherwise)
- Customer and purchase order number

Ship prepaid COM material to:
 JSI
 Attn: COM Dept
 932 Mill Street
 Jasper, IN 47546

Application of fabric:
 Railroaded Up the Roll

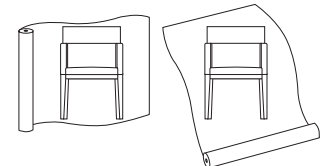

All COM orders will ship at standard lead time from receipt of COM except for orders requiring special custom matched finishes.

For Solara Lounge Seating, see page 393.

Description

1 Model

Specifications

List Price Per Grade

Guest Chair

S07335

- upholstered arms
- partially upholstered back
- back has polypropylene webbing and polyurethane foam with Dacron® wrap

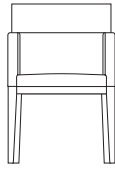

Dimensions			
	D	W	H
Overall	25	22 ½	32 ½
Seat	19	20	18 ½
Arm			26 ½
Upholstery		Shipping	
COM Ydg	2 ¼	Ctn Wt	46
COL Sq Ft	41	Cu Ft	13

COM	\$1,478
A	\$1,498
B	\$1,537
COL/C	\$1,606
D	\$1,693
E	\$1,781
F	\$1,875
G	\$2,006
H	\$2,147
I	\$2,367
J	\$2,631
L1	\$2,032
L2	\$2,173

GUEST

To Order, Specify:

- 1 Model Number
- 2 Wood Species - Maple (M)
- 3 Wood Finish
- 4 Fabric Selection - vendor, pattern and color

3 Wood Finish Options:

ALE	Ale	FLX	Flax
AUB	Auburn	CGR	Graphite Coordinate
AUT	Autumn	CHL	High Line Coordinate
BRL	Barley	CKK	Khaki Coordinate
CBE	Blonde Echo Coordinate	LGC	Legacy
BBN	Bourbon	MCH	Mocha
CBZ	Brazilwood Coordinate	NTO	Night Owl
BRG	Brighton	PRL	Praline
BUT	Butterscotch	SAF	Saffron
CIN	Cinnamon	SIE	Sienna
CLA	Classic	CST	Studio Teak Coordinate
CCF	Coffee Coordinate	TOF	Toffee
CCR	Cremello Coordinate	TRF	Truffle
EAR	Earthy	VEN	Venetian
ESP	Espresso	CWH	Walnut Heights Coordinate

Specifications

- Exposed wood seat frame species - Maple.
- Frame exterior is joined with dowels, seat base is reinforced with corner blocks.
- Seat has synthetic sheet webbing with high resiliency seat polyurethane foam and Dacron® wrap.

- 4 See a selection of graded in fabric manufacturers and patterns on pages 12-20. Contact Customer Service for additional fabric options.

Sosa Order Check List:



Specify:

- 1. Model Number
- 2. Wood Species - Maple (M)
- 3. Wood Finish
- 4. Fabric Selection - vendor, pattern and color
- 5. Optional Back Stitching Detail - Add \$40 list (model SA1061D only)
- 6. Optional Rubber Cushion Nylon Glides - no upcharge

Example:

SA1061D | M | AUB | MOMENTUM | VOX | MYSTIC
 (model #) | (wood species) | (finish) | (fabric vendor) | (pattern name) | (pattern color)

1. Model Number

2. Wood Species - Maple (M)

3. Wood Finish Options:

ALE Ale	FLX Flax
AUB Auburn	CGR Graphite Coordinate
AUT Autumn	CHL High Line Coordinate
BRL Barley	CKC Khaki Coordinate
CBE Blonde Echo Coordinate	LGC Legacy
BBN Bourbon	MCH Mocha
CBZ Brazilwood Coordinate	NTO Night Owl
BRG Brighton	PRL Praline
BUT Butterscotch	SAF Saffron
CIN Cinnamon	SIE Sienna
CLA Classic	CST Studio Teak Coordinate
CCF Coffee Coordinate	TOF Toffee
CCR Cremello Coordinate	TRF Truffle
EAR Earthy	VEN Venetian
ESP Espresso	CWH Walnut Heights Coordinate

4. Fabric Selection - Please supply the following:

- Fabric vendor
- Pattern name
- Pattern color

When specifying contrasting upholstery, indicate clearly which upholstery is to be applied to the seat and back. Use higher grade pricing.

- Indicate direction of fabric - Railroaded or Up the Roll
- Please provide illustration, if available

All COM orders must include the following:

- Vendor's name, pattern name and color
- Sample of the fabric attached to order
- Model numbers of items for fabric application
- Special application instructions (e.g., all stripes will be applied front to back unless specified otherwise)
- Customer and purchase order number

Ship prepaid COM material to:
 JSI
 Attn: COM Dept
 932 Mill Street
 Jasper, IN 47546

Application of fabric:
 Railroaded Up the Roll

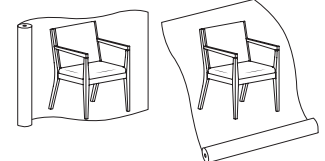

All COM orders will ship at standard lead time from receipt of COM except for orders requiring special custom matched finishes.

5. Optional Back Stitching Detail - add \$40 list (available on model SA1061D only). Specify SBS001 for Cross Stitch Detail or SBS002 for Dual Horizontal Stitch Detail.





SBS001-
Cross Stitch Detail





SBS002
Dual Horizontal Stitch Detail

6. Optional Rubber Cushion Nylon Glides - no upcharge

Description	1 Model	Specifications			List Price Per Grade	
Guest Chair 	SA1061C · upholstered seat · wood back	Dimensions	D	W	H	COM \$720
		Overall	23 ½	23	33 ¼	A \$739
		Seat	19 ½	22 ¾	18	B \$753
		Arm			26 ⅞	COL/C \$779
		Upholstery		Shipping		D \$812
		COM Ydg	¾	Ctn Wt	25	E \$845
		COL Sq Ft	14	Cu Ft	12	F \$896
						G \$951
						H \$1,010
						I \$1,101

Description	1 Model	Specifications			List Price Per Grade	
Guest Chair 	SA1061E · upholstered seat · partial upholstered back	Dimensions	D	W	H	COM \$821
		Overall	23 ½	23	33 ¼	A \$846
		Seat	18 ⅞	22 ¾	18	B \$870
		Arm			26 ⅞	COL/C \$913
		Upholstery		Shipping		D \$968
		COM Ydg	1 ¼	Ctn Wt	28	E \$1,023
		COL Sq Ft	23	Cu Ft	12	F \$1,108
						G \$1,200
						H \$1,297
						I \$1,451

Description	1 Model	Specifications			List Price Per Grade	
Guest Chair   	SA1061D · upholstered seat · fully upholstered back · optional back stitching detail available; specify SBS001 or SBS002 - add \$40 list	Dimensions	D	W	H	COM \$827
		Overall	23 ½	23	33 ¼	A \$854
		Seat	18 ⅞	22 ¾	18	B \$884
		Arm			26 ⅞	COL/C \$935
		Upholstery		Shipping		D \$1,001
		COM Ydg	1 ½	Ctn Wt	28	E \$1,067
		COL Sq Ft	27	Cu Ft	12	F \$1,169
						G \$1,279
						H \$1,397
						I \$1,580

To Order, Specify:

- 1 Model Number
- 2 Wood Species - Maple (M)
- 3 Wood Finish
- 4 Fabric Selection - vendor, pattern and color
- 5 Optional Back Stitching Detail - add \$40 list (model SA1061D only)
- 6 Optional Rubber Cushion Nylon Glides - no upcharge

3 Wood Finish Options:

- | | |
|----------------------------|-------------------------------|
| ALE Ale | FLX Flax |
| AUB Auburn | CGR Graphite Coordinate |
| AUT Autumn | CHL High Line Coordinate |
| BRL Barley | CKC Khaki Coordinate |
| CBE Blonde Echo Coordinate | LGC Legacy |
| BBN Bourbon | MCH Mocha |
| CBZ Brazilwood Coordinate | NTO Night Owl |
| BRG Brighton | PRL Praline |
| BUT Butterscotch | SAF Saffron |
| CIN Cinnamon | SIE Sienna |
| CLA Classic | CST Studio Teak Coordinate |
| CCF Coffee Coordinate | TOF Toffee |
| CCR Cremello Coordinate | TRF Truffle |
| EAR Earthy | VEN Venetian |
| ESP Espresso | CWH Walnut Heights Coordinate |

Specifications

- Wood species - Maple.
- Seat has ½" plywood with synthetic sheet webbing and 2" high density polyurethane foam.
- Solid hardwood back frame with synthetic sheet webbing and 1" polyurethane foam.
- Mortise and tenon construction with corner blocks, glue and screws.
- Wall saver feature.
- Standard with rubber cushion metal glides.

4 See a selection of graded in fabric manufacturers and patterns on pages 12-20. Contact Customer Service for additional fabric options.

GUEST

Sultan Order Check List:



Specify:

- 1. Model Number
- 2. Wood Species - Beech (B)
- 3. Wood Finish
- 4. Fabric Selection - vendor, pattern and color
- 5. Optional Ruber Cushion Nylon Glides - no upcharge

Example:

SL3101D | B | AUB | MOMENTUM | VOX | MYSTIC
 (model #) | (wood species) | (finish) | (fabric vendor) | (pattern name) | (pattern color)

1. Model Number

2. Wood Species - Beech (B)

3. Wood Finish Options:

ALE Ale	FLX Flax
AUB Auburn	CGR Graphite Coordinate
AUT Autumn	CHL High Line Coordinate
BRL Barley	CKC Khaki Coordinate
CBE Blonde Echo Coordinate	LGC Legacy
BBN Bourbon	MCH Mocha
CBZ Brazilwood Coordinate	NTO Night Owl
BRG Brighton	PRL Praline
BUT Butterscotch	SAF Saffron
CIN Cinnamon	SIE Sienna
CLA Classic	CST Studio Teak Coordinate
CCF Coffee Coordinate	TOF Toffee
CCR Cremello Coordinate	TRF Truffle
EAR Earthy	VEN Venetian
ESP Espresso	CWH Walnut Heights Coordinate

4. Fabric Selection - Please supply the following:

- Fabric vendor
- Pattern name
- Pattern color

When specifying contrasting upholstery, indicate clearly which upholstery is to be applied to the seat, back and arms. Use higher grade pricing.

- Indicate direction of fabric - Railroaded or Up the Roll
- Please provide illustration, if available

All COM orders must include the following:

- Vendor's name, pattern name and color
- Sample of the fabric attached to order
- Model numbers of items for fabric application
- Special application instructions (e.g., all stripes will be applied front to back unless specified otherwise)
- Customer and purchase order number

Ship prepaid COM material to:
 JSI
 Attn: COM Dept
 932 Mill Street
 Jasper, IN 47546

Application of fabric:
 Railroaded Up the Roll

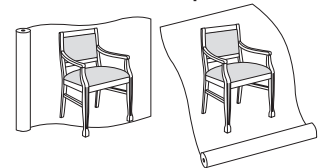

All COM orders will ship at standard lead time from receipt of COM except for orders requiring special custom matched finishes.

5. Optional Rubber Cushion Nylon Glides - no upcharge

Description	1 Model	Specifications			List Price Per Grade	
Guest Chair 	SL3101D · open arms · upholstered seat and back	Dimensions	D	W	H	COM \$753
		Overall	23	22 ¼	35 ½	A \$763
		Seat	19 ¼	18 ¼	19	B \$780
		Arm			26 ¼	COL/C \$810
		Upholstery	Shipping			D \$850
		COM Ydg	1	Ctn Wt	30	E \$889
		COL Sq Ft	18	Cu Ft	14	F \$930
						G \$989
						H \$1,050
						I \$1,149
				J \$1,266		
				L1 \$1,000		
				L2 \$1,063		

Description	1 Model	Specifications			List Price Per Grade	
Guest Chair 	SL3103D · armless · upholstered seat and back	Dimensions	D	W	H	COM \$679
		Overall	23	22 ¼	35 ½	A \$688
		Seat	19 ¼	18 ¼	19	B \$705
		Arm				COL/C \$735
		Upholstery	Shipping			D \$775
		COM Ydg	1	Ctn Wt	28	E \$814
		COL Sq Ft	18	Cu Ft	14	F \$855
						G \$914
						H \$976
						I \$1,075
				J \$1,191		
				L1 \$926		
				L2 \$989		

GUEST

To Order, Specify:

- 1 Model Number
- 2 Wood Species - Beech (B)
- 3 Wood Finish
- 4 Fabric Selection - vendor, pattern and color
- 5 Optional Rubber Cushion Nylon Glides - no upcharge

3 Wood Finish Options:

ALE Ale	FLX Flax
AUB Auburn	CGR Graphite Coordinate
AUT Autumn	CHL High Line Coordinate
BRL Barley	CKC Khaki Coordinate
CBE Blonde Echo Coordinate	LGC Legacy
BBN Bourbon	MCH Mocha
CBZ Brazilwood Coordinate	NTO Night Owl
BRG Brighton	PRL Praline
BUT Butterscotch	SAF Saffron
CIN Cinnamon	SIE Sienna
CLA Classic	CST Studio Teak Coordinate
CCF Coffee Coordinate	TOF Toffee
CCR Cremello Coordinate	TRF Truffle
EAR Earthy	VEN Venetian
ESP Espresso	CWH Walnut Heights Coordinate

Specifications

- Wood species - Beech.
- Seat has synthetic sheet webbing, one layer of 2" polyurethane foam.
- Back has 1" polyurethane foam.
- Mortise and tenon construction with corner blocks, glue and screws.
- Standard with rubber cushion metal glides.

- 4 See a selection of graded in fabric manufacturers and patterns on pages 12-20. Contact Customer Service for additional fabric options.

Tara Order Check List:



Specify:

- 1. Model Number
- 2. Wood Species - Maple (M)
- 3. Wood Finish
- 4. Fabric Selection - vendor, pattern and color
- 5. Optional Rubber Cushion Nylon Glides - no upcharge

Example:

TA6081P (model #)	M (wood species)	AUB (finish) wood legs	MOMENTUM (fabric vendor)	VOX (pattern name)	MYSTIC (pattern color)
-----------------------------	----------------------------	-------------------------------------	------------------------------------	------------------------------	----------------------------------

1. Model Number

- Special application instructions (e.g., all stripes will be applied front to back unless specified otherwise)
- Customer and purchase order number

2. Wood Species - Maple (M)

3. Wood Leg Finish Options:

ALE Ale	FLX Flax
AUB Auburn	CGR Graphite Coordinate
AUT Autumn	CHL High Line Coordinate
BRL Barley	CKC Khaki Coordinate
CBE Blonde Echo Coordinate	LGC Legacy
BBN Bourbon	MCH Mocha
CBZ Brazilwood Coordinate	NTO Night Owl
BRG Brighton	PRL Praline
BUT Butterscotch	SAF Saffron
CIN Cinnamon	SIE Sienna
CLA Classic	CST Studio Teak Coordinate
CCF Coffee Coordinate	TOF Toffee
CCR Cremello Coordinate	TRF Truffle
EAR Earthy	VEN Venetian
ESP Espresso	CWH Walnut Heights Coordinate

Ship prepaid COM material to:
 JSI
 Attn: COM Dept
 932 Mill Street
 Jasper, IN 47546

Application of fabric:
 Railroaded Up the Roll

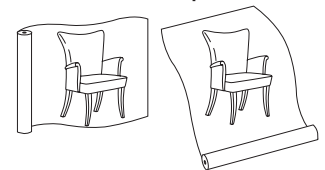

All COM orders will ship at standard lead time from receipt of COM except for orders requiring special custom matched finishes.

5. Optional Rubber Cushion Nylon Glides - no upcharge

For Tara Swivel Seating, see page 61.

4. Fabric Selection - Please supply the following:

- Fabric vendor
- Pattern name
- Pattern color

When specifying contrasting upholstery, indicate clearly which upholstery is to be applied to the seat, back and arms. Use higher grade pricing.

- Indicate direction of fabric - Railroaded or Up the Roll
- Please provide illustration, if available

All COM orders must include the following:

- Vendor's name, pattern name and color
- Sample of the fabric attached to order
- Model numbers of items for fabric application

Description	① Model	Specifications			List Price Per Grade	
Guest Chair 	TA6081P · plain back	Dimensions	D	W	H	COM \$1,340
		Overall	28	29 ½	39	A \$1,376
		Seat	20	19 ½	19	B \$1,445
		Arm			26 ½	COL/C \$1,567
		Upholstery	Shipping			D \$1,724
		COM Ydg	4	Ctn Wt	28	E \$1,880
		COL Sq Ft	72	Cu Ft	12	F \$2,045
						G \$2,279
						H \$2,529
						I \$2,921
				J \$3,390		
				L1 \$2,326		
				L2 \$2,576		

Description	① Model	Specifications			List Price Per Grade	
Guest Chair 	TA6081S · single stitch	Dimensions	D	W	H	COM \$1,386
		Overall	28	29 ½	39	A \$1,422
		Seat	20	19 ½	19	B \$1,491
		Arm			26 ½	COL/C \$1,613
		Upholstery	Shipping			D \$1,770
		COM Ydg	4	Ctn Wt	28	E \$1,926
		COL Sq Ft	72	Cu Ft	12	F \$2,091
						G \$2,325
						H \$2,575
						I \$2,967
				J \$3,436		
				L1 \$2,372		
				L2 \$2,622		

Description	① Model	Specifications			List Price Per Grade	
Guest Chair 	TA6081B · button stitch	Dimensions	D	W	H	COM \$1,389
		Overall	28	29 ½	39	A \$1,424
		Seat	20	19 ½	19	B \$1,494
		Arm			26 ½	COL/C \$1,615
		Upholstery	Shipping			D \$1,772
		COM Ydg	4	Ctn Wt	28	E \$1,928
		COL Sq Ft	72	Cu Ft	12	F \$2,093
						G \$2,327
						H \$2,577
						I \$2,969
				J \$3,438		
				L1 \$2,375		
				L2 \$2,624		

To Order, Specify:

- ① Model Number
- ② Wood Species - Maple (M)
- ③ Wood Finish
- ④ Fabric Selection - vendor, pattern and color
- ⑤ Optional Rubber Cushion Nylon Glides - no upcharge

③ Wood Finish Options:

ALE Ale	FLX Flax
AUB Auburn	CGR Graphite Coordinate
AUT Autumn	CHL High Line Coordinate
BRL Barley	CKC Khaki Coordinate
CBE Blonde Echo Coordinate	LGC Legacy
BBN Bourbon	MCH Mocha
CBZ Brazilwood Coordinate	NTO Night Owl
BRG Brighton	PRL Praline
BUT Butterscotch	SAF Saffron
CIN Cinnamon	SIE Sienna
CLA Classic	CST Studio Teak Coordinate
CCF Coffee Coordinate	TOF Toffee
CCR Cremello Coordinate	TRF Truffle
EAR Earthy	VEN Venetian
ESP Espresso	CWH Walnut Heights Coordinate

Specifications

- Wood species - Maple.
- Seat has synthetic sheet webbing and 4" polyurethane foam.
- Back has polypropylene webbing, 1 ¼" polyurethane foam with Dacron® wrap.
- Arms have 1" polyurethane foam with Dacron wrap.
- Spiral grooved hardwood dowels with corner blocks, glue and screws.
- Standard with rubber cushion metal glides.

④ See a selection of graded in fabric manufacturers and patterns on pages 12-20. Contact Customer Service for additional fabric options.

Totem Order Check List:



Specify:

- 1. Model Number
- 2. Fabric Selection - vendor, pattern and color

Example:

TM24R | MOMENTUM | VOX | MYSTIC
 (model #) | (fabric vendor) | (pattern name) | (pattern color)

1. Model Number

2. Fabric Selection - Please supply the following:

- Fabric vendor
- Pattern name
- Pattern color

When specifying contrasting upholstery, indicate clearly which upholstery is to be applied to the top and to the side. Use higher grade pricing.

- Indicate direction of fabric - Railroaded or Up the Roll
- Please provide illustration, if available

All COM orders must include the following:

- Vendor's name, pattern name and color
- Sample of the fabric attached to order
- Model numbers of items for fabric application
- Special application instructions (e.g., all stripes will be applied front to back unless specified otherwise)
- Customer and purchase order number

Ship prepaid COM material to:
 JSI
 Attn: COM Dept
 932 Mill Street
 Jasper, IN 47546

Application of fabric:
 Railroaded

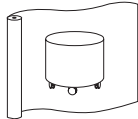

All COM orders will ship at standard lead time from receipt of COM.

GUEST

Description	① Model	Specifications				List Price Per Grade
		Dimensions	D	W	H	
Round Pod 	TM17 · upholstered base · five 1" diameter black nylon glides	Overall	17		18	COM \$495
		Seat			18	A \$522
		Upholstery		Shipping		B \$561
		COM Ydg	2	Ctn Wt	20	COL/C \$630
		COL Sq Ft	36	Cu Ft	5	D \$718
						E \$806
						F \$942
				G \$1,089		
				H \$1,246		
				I \$1,490		
				J \$1,783		
				L1 \$1,119		
				L2 \$1,275		

Description	① Model	Specifications				List Price Per Grade
		Dimensions	D	W	H	
Round Pod 	TM24 · upholstered base · five 1" diameter black nylon glides	Overall	24		18	COM \$625
		Seat			18	A \$661
		Upholstery		Shipping		B \$710
		COM Ydg	2 ½	Ctn Wt	32	COL/C \$795
		COL Sq Ft	45	Cu Ft	8	D \$906
						E \$1,016
						F \$1,187
				G \$1,370		
				H \$1,565		
				I \$1,871		
				J \$2,237		
				L1 \$1,406		
				L2 \$1,602		

Description	① Model	Specifications				List Price Per Grade
		Dimensions	D	W	H	
Mobile Round Pod 	TM24C · upholstered base · five 80 mm casters	Overall	24		18	COM \$733
		Seat			18	A \$769
		Upholstery		Shipping		B \$818
		COM Ydg	2 ½	Ctn Wt	32	COL/C \$903
		COL Sq Ft	45	Cu Ft	8	D \$1,014
						E \$1,124
						F \$1,295
				G \$1,478		
				H \$1,673		
				I \$1,979		
				J \$2,345		
				L1 \$1,515		
				L2 \$1,710		

To Order, Specify:

- ① Model Number
- ② Fabric Selection - vendor, pattern and color

② See a selection of graded in fabric manufacturers and patterns on pages 12-20. Contact Customer Service for additional fabric options.

Specifications

- Wood frame.
- Pod is upholstered with 2" high density polyurethane foam.

GUEST

Waltham Order Check List:



Specify:

- 1. Model Number
- 2. Wood Species - Maple (M)
- 3. Wood Finish
- 4. Fabric Selection - vendor, pattern and color

Example:

WA8060 (model #)	M (wood species)	AUB (finish)	MOMENTUM (fabric vendor)	VOX (pattern name)	MYSTIC (pattern color)
----------------------------	----------------------------	------------------------	------------------------------------	------------------------------	----------------------------------

1. Model Number

2. Wood Species - Maple (M)

3. Wood Finish Options:

ALE Ale	FLX Flax
AUB Auburn	CGR Graphite Coordinate
AUT Autumn	CHL High Line Coordinate
BRL Barley	CKC Khaki Coordinate
CBE Blonde Echo Coordinate	LGC Legacy
BBN Bourbon	MCH Mocha
CBZ Brazilwood Coordinate	NTO Night Owl
BRG Brighton	PRL Praline
BUT Butterscotch	SAF Saffron
CIN Cinnamon	SIE Sienna
CLA Classic	CST Studio Teak Coordinate
CCF Coffee Coordinate	TOF Toffee
CCR Cremello Coordinate	TRF Truffle
EAR Earthy	VEN Venetian
ESP Espresso	CWH Walnut Heights Coordinate

4. Fabric Selection - Please supply the following:

- Fabric vendor
- Pattern name
- Pattern color

When specifying contrasting upholstery, indicate clearly which upholstery is to be applied to the seat and back. Use higher grade pricing.

- Indicate direction of fabric - Railroaded or Up the Roll
- Please provide illustration, if available

All COM orders must include the following:

- Vendor's name, pattern name and color
- Sample of the fabric attached to order
- Model numbers of items for fabric application
- Special application instructions (e.g., all stripes will be applied front to back unless specified otherwise)
- Customer and purchase order number

Ship prepaid COM material to:
 JSI
 Attn: COM Dept
 932 Mill Street
 Jasper, IN 47546

Application of fabric:
 Railroaded Up the Roll

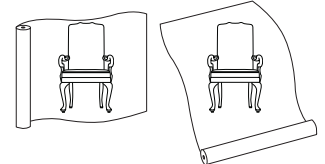

All COM orders will ship at standard lead time from receipt of COM except for orders requiring special custom matched finishes.

For Waltham Swivel Seating, see page 71.

Description

1 Model

Specifications

List Price Per Grade

Guest Chair

WA8060

- open wood arm
- upholstered seat and back

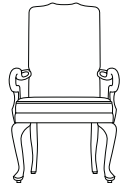

Dimensions	D	W	H
Overall	31	27	42 ½
Seat	17 ¾	22 ½	19 ¼
Arm			26
Upholstery		Shipping	
COM Ydg	2 ¼	Ctn Wt	37
COL Sq Ft	41	Cu Ft	23

COM	\$1,297
A	\$1,317
B	\$1,356
COL/C	\$1,425
D	\$1,512
E	\$1,601
F	\$1,694
G	\$1,825
H	\$1,966
I	\$2,187
J	\$2,450
L1	\$1,852
L2	\$1,992

GUEST

To Order, Specify:

- 1 Model Number
- 2 Wood Species - Maple (M)
- 3 Wood Finish
- 4 Fabric Selection - vendor, pattern and color

3 Wood Finish Options:

ALE	Ale	FLX	Flax
AUB	Auburn	CGR	Graphite Coordinate
AUT	Autumn	CHL	High Line Coordinate
BRL	Barley	CKK	Khaki Coordinate
CBE	Blonde Echo Coordinate	LGC	Legacy
BBN	Bourbon	MCH	Mocha
CBZ	Brazilwood Coordinate	NTO	Night Owl
BRG	Brighton	PRL	Praline
BUT	Butterscotch	SAF	Saffron
CIN	Cinnamon	SIE	Sienna
CLA	Classic	CST	Studio Teak Coordinate
CCF	Coffee Coordinate	TOF	Toffee
CCR	Cremello Coordinate	TRF	Truffle
EAR	Earthy	VEN	Venetian
ESP	Espresso	CWH	Walnut Heights Coordinate

Specifications

- Wood species - Maple.
- Frame exterior is joined with dowels.
- Seat box is reinforced with corner blocks.
- Hardwood interior frame is joined with double dowels.
- Seat has synthetic sheet webbing with high resiliency seat polyurethane foam.
- Back interior is polyurethane foam.

- 4 See a selection of graded in fabric manufacturers and patterns on pages 12-20. Contact Customer Service for additional fabric options.

Lounge Seating Overview



BeSPACE® 134



Collective Lounge 177



Collective Motion 182



Connect **NOW!** 200



Corbin **NOW!** 276



Encore **NOW!** 280



Finn 298



Finn Nu 304



Focus 309



Harbor 312

LOUNGE

Lounge Seating Overview



Hedron **NOW!** 314



Hudson 326



Luci 329



Moto 332



Olympian **NOW!** 376



Portrait 390



Solara 393



Ziva 397

LOUNGE

BeSPACE Order Check List:



Specify:

- 1. Model Number
- 2. Wood Species - Rift Cut White Oak (WK4) or Flat Cut Walnut (WA1)
- 3. Finish Option - CLK (Clear on Rift Cut White Oak) or CLW (Clear on Flat Cut Walnut)
- 4. Door or Drawer Front Optional Paint Color (see below for paint color options); no upcharge
- 5. Metal Leg Color - Matte Black (MBK), Soft Nickel (SNK) or Stardust Silver (STS)
- 6. Fabric Selection
 - A. Seat - Vendor, Pattern and Color
 - B. Back - Vendor, Pattern and Color
 - C. Deck or Deck and Arm (s) - Vendor, Pattern and Color
- 7. Glass Color - Clear (GTC01) or Smoke (GTC04)
- 8. Optional Power Center - Flush Mount (EC22) - Black (B) or White (W); add \$504 list each
- 9. Optional Black Grommet; add \$79 list each

Example:

BS2 (model #)	WA1 (wood species)	CLW (finish)	SNK (metal leg color)	MOMENTUM (fabric vendor)	INSIGHT (pattern name)	FOSSIL (pattern color)
-------------------------	------------------------------	------------------------	---------------------------------	------------------------------------	----------------------------------	----------------------------------

1. Model Number

2. Wood Species - Rift Cut White Oak (WK4) or Flat Cut Walnut (WA1)

3. Wood Finish Options:

- CLK Clear on Rift Cut White Oak
- CLW Clear on Flat Cut Walnut

4. Door or Drawer Front Optional Paint Color:

- | | |
|------------------|----------------------|
| BKD Backdrop | GRV Greek Villa |
| BFX Black Fox | NET Network Gray |
| BWH Bright White | NWH Nonchalant White |
| CGP Cargo Pants | STM Storm |
| CHT Chatroom | TRC Tricorn Black |
| FRR French Roast | |

5. Metal Leg Color - Matte Black (MBK), Soft Nickel (SNK) or Stardust Silver (STS)

6. Fabric Selection - Please supply the following:

- Fabric vendor
- Pattern name
- Pattern color

Contrasting Upholstery - Units can be specified with a contrasting upholstery feature. When this feature is desired the unit **will be priced based on the higher grade fabric** selected for the seat, back, deck or deck and arm (s).

When specifying contrasting upholstery, indicate clearly the upholstery to be applied to the seat, back, deck or deck and arm (s).

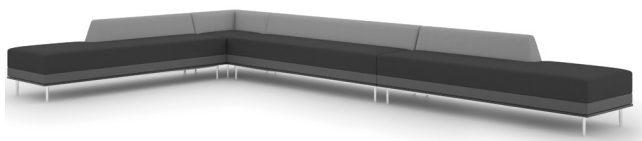

- Fabric will be applied "up the roll" unless specified "railroaded"
- Please provide illustration, if available

All COM orders must include the following:

- Fabric vendor's name, pattern name and color
- Sample of the fabric attached to order
- Model numbers of items for fabric application
- Special application instructions (e.g., all stripes will be applied front to back unless specified otherwise)
- Customer and purchase order number

Ship prepaid COM material to:
JSI
Attn: COM Dept
932 Mill Street
Jasper, IN 47546

Application of fabric:
Railroaded Up the Roll

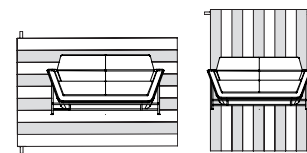

7. Glass Color:

- | | |
|-------------|-------------|
| GTC01 Clear | GTC04 Smoke |
|-------------|-------------|

8. Optional Power Center (EC22) - add \$504 list, specify color and location

9. Optional Black Grommet - add \$79 list

Seating

Wood Materials

Exterior surfaces are laminated veneers either in plain sliced walnut or rift cut white oak.

Seating exterior components are made up of layers of hardwood veneer molded to shape and RF cured. Outer veneers are matched for a uniform grain pattern. Exterior plywood is 5/8" thick.

Interior seating frame and support components are made from 3/4" interior grade plywood.

Metal Materials

Exterior feet and leg frames are fabricated from 14 gauge steel tubing and welded to pre-set standards.

Construction

Seating interior frames are constructed with upholstery grade plywood with precisely cut interlocking joints. All joints are glued and reinforced with staples. Critical joints are fastened with screws to reinforce the joint. Frame components are assembled using t-nuts for metal to metal connection.

Upholstery Details

Seating suspension for modular units has a 3-1/2" high-resilience seat foam placed onto sheet webbing for comfort and durability. Back and arm foam is a high density foam for comfort and durability.

Freestanding upholstered units have 6" thick high-resilience seat foam for durability. The bottom of the seat plywood is ventilated to allow the seat foam to breathe. Back and arm foam is a high density foam for comfort and durability.

Single needle top stitch is used on all BeSPACE models.

Exterior Metal Components

Leg frame is welded to pre-set standards and then the outer surfaces are prepared for powder coating. Leg frame and glide will be same color.

Three powder coat finishes are available:

Matte Black	MBK
Soft Nickel	SNK
Stardust Silver	STS

Legs with adjustable glides are mounted with internal connections which are embedded into the plywood exterior. The angular cut matches up with the plywood exterior for a floating appearance.

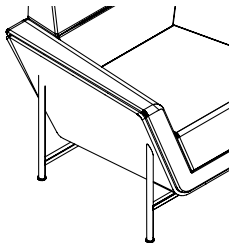

Special Features

Model BS-1 Lounge Chair with the swivel mechanism and four prong base with non-adjustable push-in glides features a 360° swivel. The standard 3.5° rearward tilt is welded in to the spindle of the mechanism plate, the spindle sits into a passive hub of the prong base.

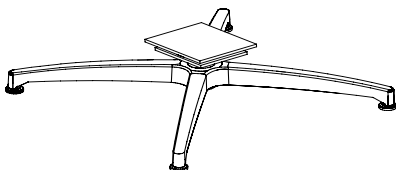

Finish

To accentuate the beauty of the walnut or white oak veneers a clear finish coat is applied to the exposed plywood shells and platforms.

Exterior Seating Plywood Shell and Platforms are available in two finishes:

Clear Coat on Walnut	CLW
Clear Coat on Rift Cut White Oak	CLK

To reduce hazardous formaldehyde emission we use our proprietary specially design top coat, DuraTex™. We are proud that our finish is GreenGuard certified.

DuraTex™, offers exceptional hardness along with abrasion and impact resistance, but has been formulated to eliminate hazardous and harmful gases that are normally associated with wood finish.

DuraTex™ Features

Safety - Significantly reduces hazardous formaldehyde emissions which help improve the quality of the indoor air we breathe.

Quality - Developed to be tough and durable with special attention to appearance. The DuraTex™ finish provides a safe solution and still preserves the natural beauty of wood.

Durability - Designed to meet a wide range of demanding performance and environmental standards to withstand even the highest wear and tear.

Care and Maintenance

Care of Upholstery Surfaces

Cleanability will vary based on the fabric type. For best results, a professional service is recommended. Dirt and crumbs may be gently brushed or vacuumed off. Spills should be wiped up immediately with a cloth. Vinyl textiles can be cleaned with warm soapy water and wiped down with a warm damp cloth. For more details on any JSI carded fabric and vinyl, please visit our website at www.jsifurniture.com or consult the back of the appropriate swatch card for cleaning codes and any specific instructions. For COM materials, consult with the individual textile manufacturer for cleaning codes and any specific instructions pertaining to your particular fabric.

Maintenance of Mechanical Parts

Clean any lint or debris from the moving parts of the base mechanisms. Mechanisms have been designed and tested to not require lubrication under normal conditions however lubricant can be used if needed.

Metal Components

Wipe smooth powder coat finishes and textured metals with a damp cloth. For stubborn stains and grease marks, use soap and water. Lightly brush textured metals with a soft, dry brush to remove dirt.

Casegoods

Wood Materials

Exterior surfaces are laminated veneers either in plain sliced walnut or rift cut white oak.

Casegood tops are made up of layers of hardwood veneers molded to shape and RF cured. Outer veneers are matched for uniform grain patterns. All casegood tops are 3/4" thick plywood.

Casegood chassis, doors and drawer fronts consist of veneer over composite wood core; all wood core components are 3/4" thick.

Metal Materials

Exterior feet are fabricated using 14 gauge steel tubing and 14 gauge flat stock.

Construction

Casegoods are constructed with a series of glued wood dowels and metal-to-wood fastening hardware to reinforce critical joints.

Feet are field installed to prevent shipping damage, pre-bored holes make installation easy. Instructions, feet, and other hardware will be packed inside the carton.

Drawer boxes are constructed from plywood components with dovetail joinery, providing superior tensile strength to the box. Under-mount drawer suspensions are "full extension" which allows the drawers to open fully. The "soft-close" mechanism allows the drawers to close with a slight push. Drawer and door fronts feature a finger pull and are non-locking. Drawers in the BeSPACE product line are not intended for filing.

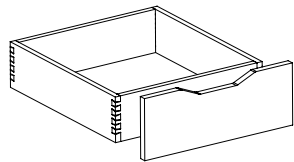

5-sided drawer box

Casegood Feet

Feet are fabricated with a flat plate which is screwed to the bottom of the casegoods. The feet have an adjustable glide for ease of leveling.

Three powder coat finishes are available.

Matte Black	MBK
Soft Nickel	SNK
Stardust Silver	STS

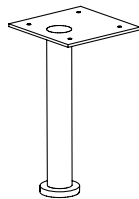

Glide matches powder coat finish selected on feet.

Credenza units have wire pass through incorporated into the interior dividers and bottom panels to allow for wiring to pass easily through the unit. A metal stress-bar runs the full length on the bottom side of the credenzas providing additional support.

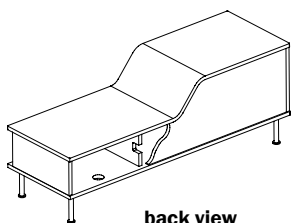

back view

Optional matte black grommets are available in the back panel but must be specified. Grommets are located as shown, center on single height units and two locations on transition height units.

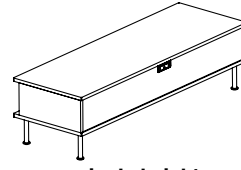
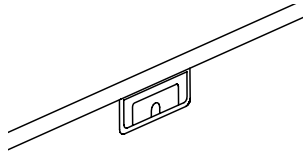

single height

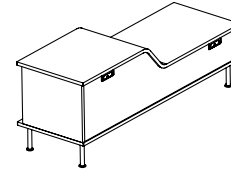

transition height

Finish

To accentuate the beauty of the walnut or white oak veneer a clear finish coat is applied to the chassis of the BeSPACE products. Drawer and door fronts can be matched with the same clear coat finish on the veneer or may be specified with a painted finish.

Chassis and Drawer or Door Fronts

Clear Coat on Rift Cut White Oak - CLW
Clear Coat on Walnut - CLK

Drawer or Door Fronts (Optional Paint on Maple Veneer)

Backdrop	BKD	Greek Villa	GRV
Black Fox	BFX	Network Gray	NET
Bright White	BWH	Nonchalant White	NWH
Cargo Pants	CGP	Storm	STM
Chatroom	CHT	Tricorn Black	TRC
French Roast	FRR		

To reduce hazardous formaldehyde emission we use our proprietary specially designed top coat, DuraTex™. We are proud that our finish is GreenGuard certified.

DuraTex™ offers exceptional hardness along with abrasion and impact resistance, but has been formulated to eliminate hazardous and harmful gases that are normally associated with wood finish.

DuraTex™ Features

Safety - Significantly reduces hazardous formaldehyde emissions which help improve the quality of the indoor air we breathe.

Quality - Developed to be tough and durable with special attention to appearance. The DuraTex™ finish provides a safe solution and still preserves the natural beauty of wood.

Durability - Designed to meet a wide range of demanding performance and environmental standards to withstand even the highest wear and tear.

Glass Tables

Glass Tops are 1/2" thick tempered and are available in Clear (low iron) or Smoke. Pliable polyurethane bumpers, along with the weight of the top, keeps the glass in place.

- Clear GTC01
- Smoke GTC04

Optional Data/Electrical Components

EC22 Power Center- Flush Mount

EC22 unit provides electric for two 110 devices and one USB 2-Port Simplex for charging. This factory installed unit is mounted in the front or back panel(s) of modular closed tables. When ordering specify color and location, see below. Power is connected to the building supply with 10' standard three prong cord. Access and storage of excess power cord is provided in the cavity of the tables.

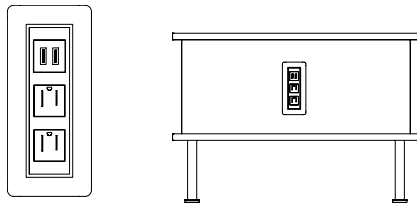

Note: Power Center color, Black (B) or White (W) must be specified.

EC21 Power Center - Under Mount

This accessory item features one 110 device and one USB 2-Port Simplex for charging. The EC21 unit is ordered separately and can be mounted on the bottom platform of casegoods and lounge seating, see "Power Center Under Mount" on page 176.

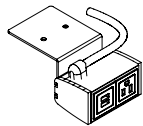

Credenza with Optional Cushions

Bench Height and Transitional Height credenza units can be ordered with an optional factory installed cushion. (Select appropriate fabric grade when pricing the unit). Cushion should not be removed due to permanent attachment.

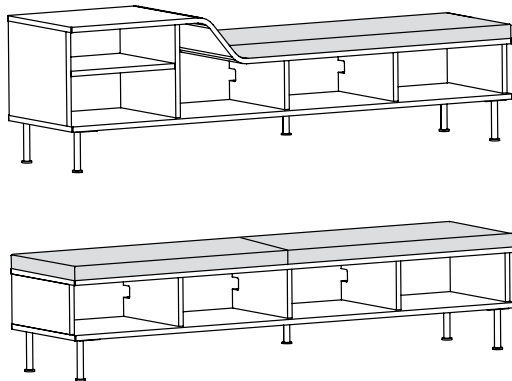

How to determine Left and Right

Left and right is determined by facing the unit; the transitional height unit determines the left or right orientation.

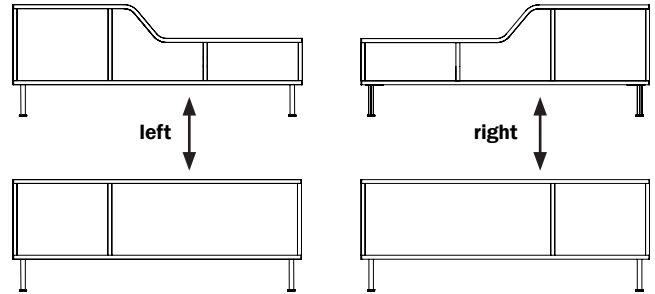

▲ Bookcase Back Heights

Bookcases are available in two heights, 48 and 68 inches tall. When ordering, please specify one of the three back height options; Full Back, Mid Back or Low Back.

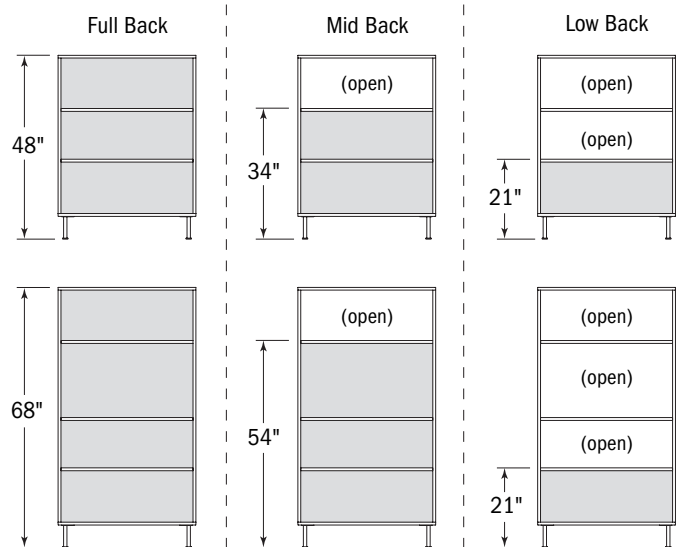

▲ Bookcase Shelving

All bookcase shelves are offered straight as standard. The lowest shelf is always fixed and straight. Upper shelves are adjustable and available with optional bent plywood. The bent plywood shelves are reversible, they can slope in either direction. When ordering bookcases with bent plywood shelves, please specify and add \$604 per shelf to list price.

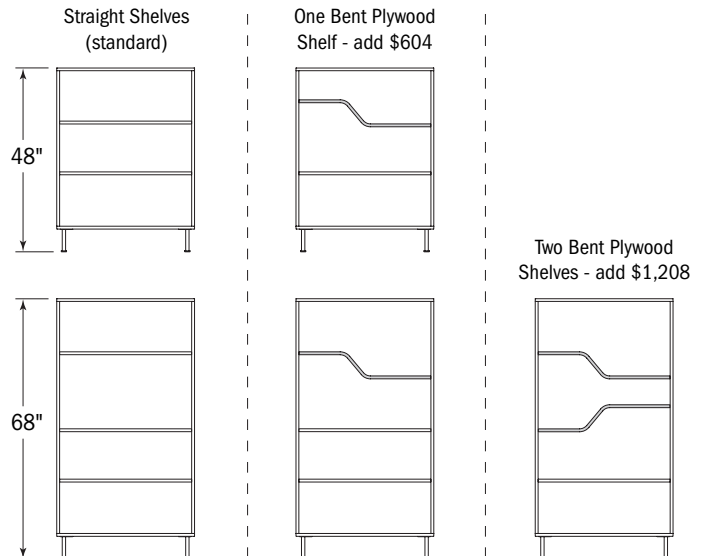

Modular Tables and Modular Lounge - Connecting

1. To create turns with in a product run, connect 120° units with other 120° units or 90° (square end) units with other 90° (square end) units to create turns.

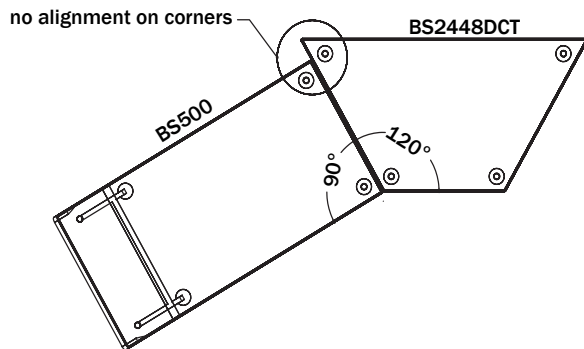
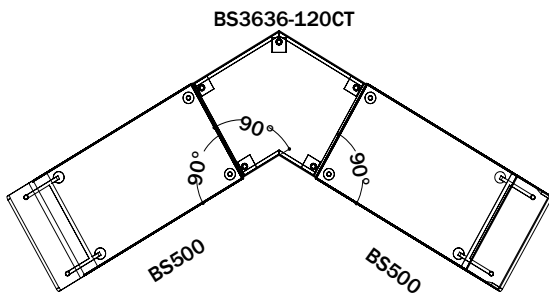
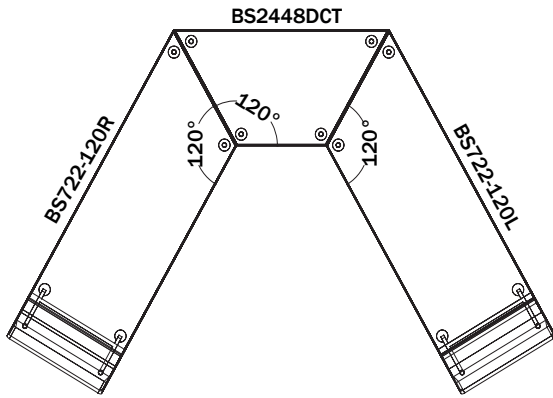

2. For a flat tailored surface corner units will have a seam on the linking side.

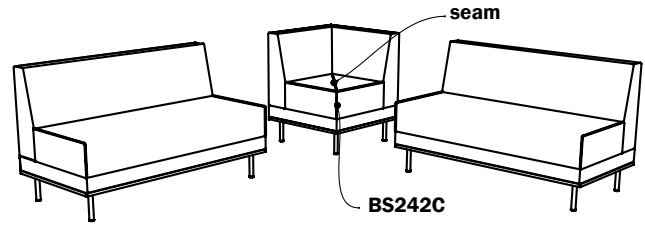
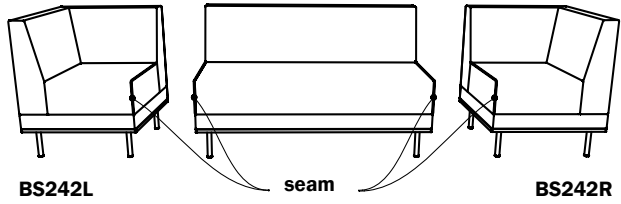

Note: 120° and 90° (square end) units cannot be connected to one another

- When using textiles with a pattern or large repeats we recommend specifying the corner units with "C" at the end of the model number. Note there will be a diagonal seam allowing for a textile match. If the upholstery cover is non-directional the diagonal seam will be eliminate

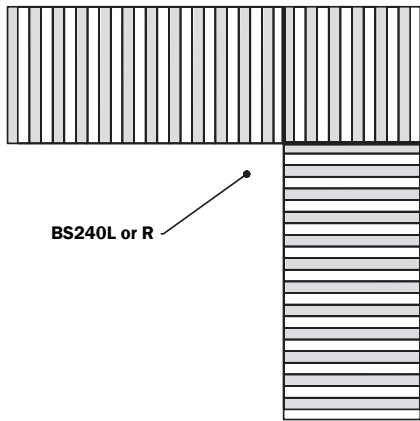
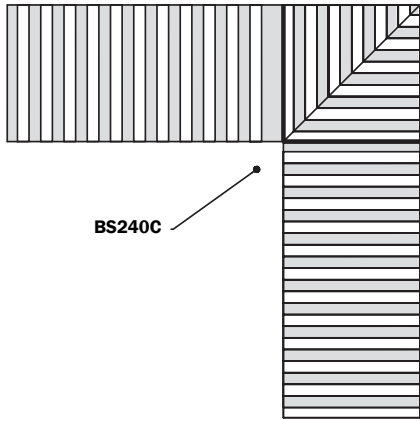

- Modular tables are shipped with connecting hardware to secure units together. The draw catch style hardware makes connection easy. Pre-bore holes are standard.

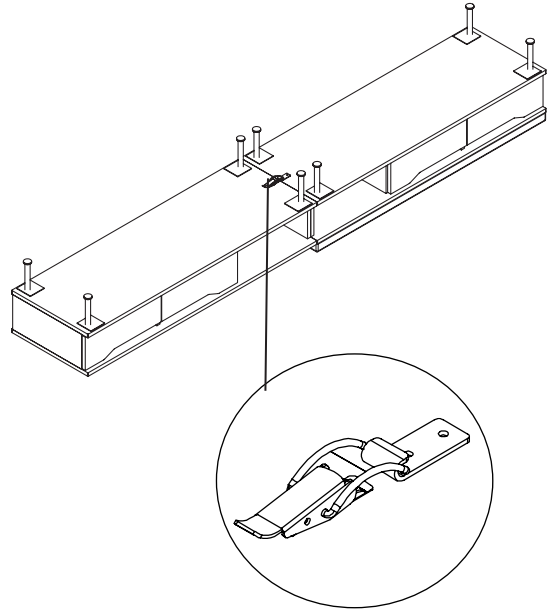

- Modular lounge units are shipped with two sets of connecting hardware to secure them together. The draw catch style hardware makes connection easy. Pre-bore holes are standard.

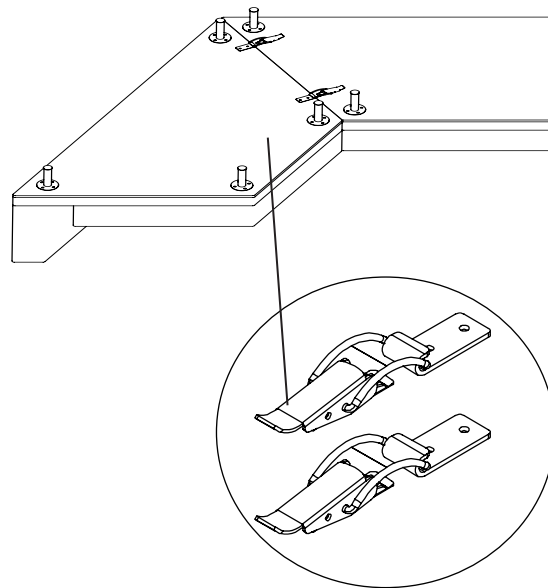

Upholstery Application

Unless the customer specifies the fabric to be "railroaded", the fabric will be "cut up the roll". Additional seaming may be needed pending fabric width and textile repeat match, contact Customer Service with questions.

"Nap" or "Up the Roll" (standard)

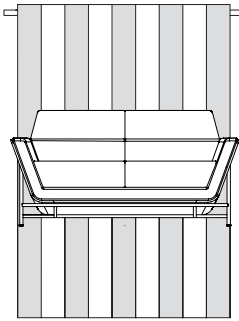

Railroaded (upon request)

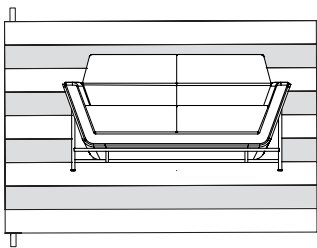

Contrasting Upholstery

Units can be specified with a contrasting upholstery feature. When this feature is desired the unit **will be priced based on the highest grade fabric**. At the time of ordering identify the location of each textile according to the following code.

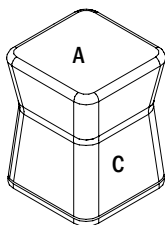
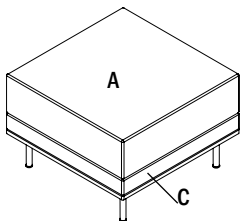
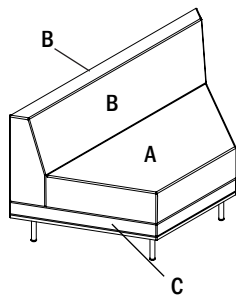
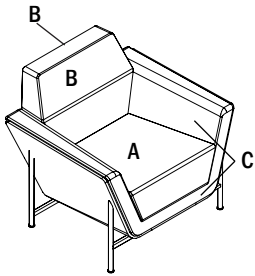

- A = Seat
- B = Front Back/Extreme Back
- C = Deck or Deck and Arm (s)

How to Determine Left and Rights

Left and right is determined as you are seated in the chair.

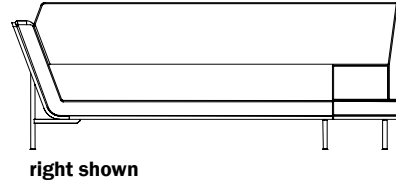
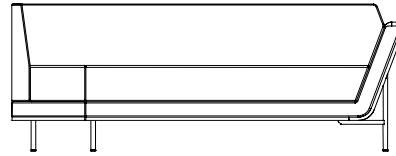

BS2424DCT Table

This corner table is designed to create a 90° (square end) turn with two modular components as shown in the example below. The "A" or "B" back panels are identified to help specify the location of the EC22 power data unit. When ordering an EC22 specify "A" and/or "B" location. The two back panels are slightly recessed. The grain runs diagonal on the table top.

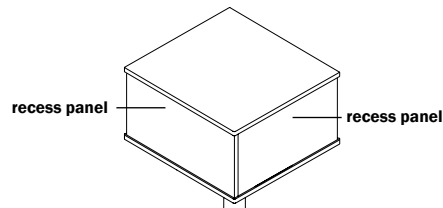
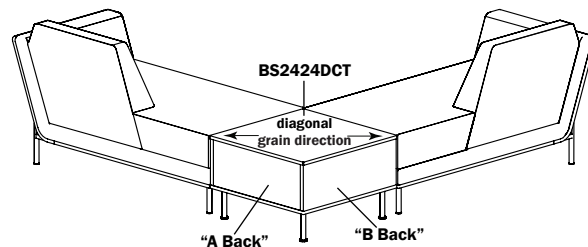

BS2424SCT Table

This table is designed to create a straight run of modular components as shown in the example below. The EC22 can be installed in the front or back panel. The front and back panel are slight recessed. The grain on this top runs side to side.

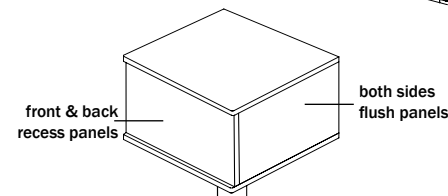
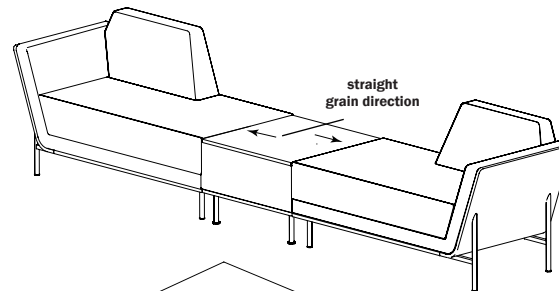

COM Yardage Requirements for Multiple Fabrics

▲ Revised 1/13/16

Model	Description	Seat Only COM Ydg	Back Only COM Ydg	Deck and Arm(s) Only COM Ydg	Deck Only COM Ydg
BS1	Lounge Chair	1.25	1	1.5	0
BS1-S	Swivel Lounge Chair	1.25	1	1.5	0
BS140	Upholstered Pod	0.75	0	0	0.75
BS140W	Upholstered Table	0.75	0	0	0.75
BS2	Sette Lounge	2.5	2	1.5	0
BS230	Ottoman	1	0	0	0
BS240	24" Straight Bench	1.25	0	0	0.5
BS240-122	120° Connecting Bench	2	0	0	0.5
BS240C	24" Corner Bench	1.25	0	0	0.5
BS242-122	120° Connecting Bench with Back	2	2	0	0.5
BS242C	Corner Bench with Back, Center	0.75	2	0	0.5
BS242L	Corner Bench with Back, Left	0.75	2	0	0.5
BS242R	Corner Bench with Back, Right	0.75	2	0	0.5
BS3	Sofa Lounge	3.75	3	1.5	0
BS480	48" Straight Bench	1.5	0	0	0.5
BS480-120L	48" Angled Bench, Left	1.5	0	0	0.5
BS480-120R	48" Angled Bench, Right	1.5	0	0	0.5
BS480-122	48" Dual Angled Bench	1.5	0	0	0.5
BS481L	48" Partial Back Bench, Left	1.5	1.5	0	0.5
BS481R	48" Partial Back Bench, Right	1.5	1.5	0	0.5
BS482	48" Straight Bench with Back	1.5	1.5	0	0.5
BS482-120L	48" Angled Bench with Back, Left	1.5	1.5	0	0.5
BS482-120R	48" Angled Bench with Back, Right	1.5	1.5	0	0.5
BS482-122	48" Dual Angled Bench with Back	1.5	1.5	0	0.5
BS500	50" Open Side Bench	1.5	0	1.25	0
BS500-120L	50" Angled Open Side Bench, Left	1.5	0	1.25	0
BS500-120R	50" Angled Open Side Bench, Right	1.5	0	1.25	0
BS501L	50" Chaise Bench with Partial Back, Left	1.5	1.75	1.25	0
BS501R	50" Chaise Bench with Partial Back, Right	1.5	1.75	1.25	0
BS502-120L	50" Angled Open Side Bench with Back, Left	1.5	1.75	1.25	0
BS502-120R	50" Angled Open Side Bench with Back, Right	1.5	1.75	1.25	0
BS502L	50" Open Side Bench with Back, Left	1.5	1.75	1.25	0
BS502R	50" Open Side Bench with Back, Right	1.5	1.75	1.25	0
BS720	72" Straight Bench	3	0	0	0.75
BS720-120L	72" Angled Bench, Left	3	0	0	0.75
BS720-120R	72" Angled Bench, Right	3	0	0	0.75
BS720-122	72" Dual Angled Bench	3	0	0	0.75
BS721L	72" Partial Back Bench, Left	3	2.25	0	0.75
BS721R	72" Partial Back Bench, Right	3	2.25	0	0.75
BS722	72" Straight Bench with Back	3	3	0	0.75
BS722-120L	72" Angled Bench with Back, Left	3	3	0	0.75
BS722-120R	72" Angled Bench with Back, Right	3	3	0	0.75
BS722-122	72" Dual Angled Bench with Back	3	3	0	0.75
BS740	74" Open Side Bench	3	0	1.5	0
BS740-120L	74" Angled Open Side Bench, Left	3	0	1.5	0
BS740-120R	74" Angled Open Side Bench, Right	3	0	1.5	0
BS741L	74" Chaise Bench with Partial Back, Left	3	2.25	1.5	0
BS741R	74" Chaise Bench with Partial Back, Right	3	2.25	1.5	0
BS742-120L	74" Angled Open Side Bench with Back, Left	2.75	3.5	1.5	0
BS742-120R	74" Angled Open Side Bench with Back, Right	2.75	3.5	1.5	0
BS742L	74" Open Side Bench with Back, Left	2.75	3.5	1.5	0
BS742R	74" Open Side Bench with Back, Right	2.75	3.5	1.5	0
BS750	Freestanding Bench	2.75	0	0	1

LOUNGE

BeSPACE – Compartment - Drawer Sizes

All sizes are rounded down to the nearest 1/4" - sizes for drawers are interior dimensions of drawer boxes.

Unless noted sizes listed are dimensions for the interior compartments – compartment shelves are fixed, shelves are non-adjustable.

	Models	A	B	C	D	E	F
	BS24240CT	9 H 22 W 22 1/4 D					
	BS24480CT	9 H 22 3/4 W 22 3/8 D					
	BS1854-16SOS	7 H 17 W 15 1/2 D					
	BS1872-16SOS	7 H 17 W 15 1/2 D					
	BS1854-16SDWR BS1854-16SDWL	4 1/4 H 15 1/4 W 10 3/4 D Drawer Interior	7 H 17 W 15 1/2 D				
	BS1872-16SDWR BS1872-16SDWL	4 1/4 H 15 1/4 W 10 3/4 D Drawer Interior	7 H 17 W 15 1/2 D				
	BS1872-16SFS	4 1/4 H 15 1/4 W 10 3/4 D Drawer Interior					
	BS1854-20SOSR BS1854-20SOSL	13 1/4 H 34 3/4 W 15 1/2 D	13 1/4 H 17 W 15 1/2 D				
	BS1872-20SOS	5 1/2 H 34 3/4 W 15 1/2 D	7 H 34 3/4 W 15 1/2 D				
	BS1854-20SDWR BS1854-20SDWL	8 1/2 H 33 W 10 3/4 D Drawer Interior	13 1/4 H 17 W 15 1/2 D				
	BS1872-20SDWR BS1872-20SDWL	8 1/2 H 33 W 10 3/4 D Drawer Interior	5 1/2 H 34 3/4 W 15 1/2 D	7 H 34 3/4 W 15 1/2 D			
	BS1872-20SFS	8 1/2 H 33 W 10 3/4 D Drawer Interior					
	BS1854-27SOSR BS1854-27SOSL	5 1/2 H 34 3/4 W 15 1/2 D	13 1/4 H 34 3/4 W 15 1/2 D	5 1/2 H 17 W 15 1/2 D	13 1/4 H 17 W 15 1/2 D		

LOUNGE

BeSPACE – Compartment - Drawer Sizes (continued)

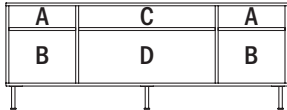
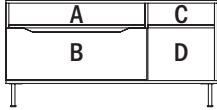
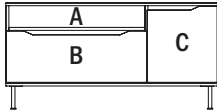
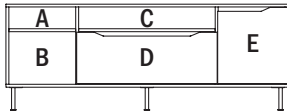
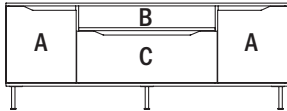
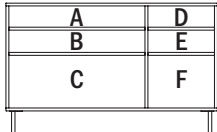
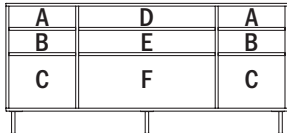
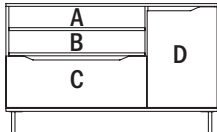
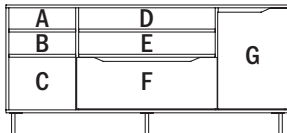
	Models	A	B	C	D	E	F
	BS1872-27SOS	5 1/2 H 17 W 15 1/2 D	13 1/4 H 17 W 15 1/2 D	5 1/2 H 34 3/4 W 15 1/2 D	13 1/4 H 34 3/4 W 15 1/2 D		
	BS1854-27SDWR BS1854-27SDWL	5 1/2 H 34 3/4 W 15 1/2 D	8 1/2 H 33 W 10 3/4 D Drawer Interior	5 1/2 H 17 W 15 1/2 D	13 1/4 H 17 W 15 1/2 D		
	BS1854-27SFSR BS1854-27SFSL	5 1/2 H 34 3/4 W 15 1/2 D	8 1/2 H 33 W 10 3/4 D Drawer Interior	5 1/2 H Top Section 13 1/4 H Bottom Section 17 W 14 3/4 D Hinge Door			
	BS1872-27SSR BS1872-27SSL	5 1/2 H 17 W 15 1/2 D	13 1/4 H 17 W 15 1/2 D	5 1/2 H 34 3/4 W 15 1/2 D	8 1/2 H 33 W 10 3/4 D Drawer Interior	5 1/2 H Top Section 13 1/4 H Bottom Section 17 W 14 3/4 D Hinge Door	
	BS1872-27SFS	5 1/2 H Top Section 13 1/4 H Bottom Section 17 W 14 3/4 D Hinge Door	5 1/2 H 34 3/4 W 15 1/2 D	8 1/2 H 33 W 10 3/4 D Drawer Interior			
	BS1854-33SOSR BS1854-33SOSL	5 1/2 H 34 3/4 W 15 1/2 D	5 1/2 H 34 3/4 W 15 1/2 D	13 1/4 H 34 3/4 W 15 1/2 D	5 1/4 H 17 W 15 1/2 D	5 1/2 H 17 W 15 1/2 D	13 1/4 H 17 W 15 1/2 D
	BS1872-33SOS	5 1/4 H 17 W 15 1/2 D	5 1/2 H 17 W 15 1/2 D	13 1/2 H 17 W 15 1/2 D	5 1/4 H 34 3/4 W 15 1/2 D	5 1/2 H 34 3/4 W 15 1/2 D	13 1/2 H 34 3/4 W 15 1/2 D
	BS1854-33SFSR BS1854-33SFSL	5 1/4 H 34 3/4 W 15 1/2 D	5 1/2 H 34 3/4 W 15 1/2 D	8 1/2 H 33 W 10 3/4 D Drawer Interior	5 1/4 H Top Section 5 1/2 H Middle Section 13 1/4 H Bottom Section 17 W 14 3/4 D Hinge Door		
	BS1872-33SSR BS1872-33SSL	5 1/4 H 17 W 15 1/2 D	5 1/2 H 17 W 15 1/2 D	13 1/4 H 17 W 15 1/2 D	5 1/4 H 34 3/4 W 15 1/2 D	5 1/2 H 34 3/4 W 15 1/2 D	8 1/2 H 33 W 10 3/4 D Drawer Interior G 5 1/4 H Top Section 5 1/2 H Middle Section 13 1/4 H Bottom Section 17 W 14 3/4 D Hinge Door

BeSPACE – Compartment - Drawer Sizes (continued)

	Models	A	B	C	D	E	F
	BS1872-33SFS	5 1/4 H Top Section 5 1/2 H Middle Section 13 1/4 H Bottom Section 17 W 14 3/4 D Hinge Door	5 1/4 H 34 3/4 W 15 1/2 D	5 1/2 H 34 3/4 W 15 1/2 D	8 1/2 H 33 W 10 3/4 D Drawer Interior		
	BS1854-20TOSR BS1854-20TOSL	7 H 17 W 15 1/2 D	7 H 13 1/4 H Transition 17 W 15 1/2 D	13 1/4 H 17 W 15 1/2 D			
	BS1872-20TOSR BS1872-20TOSL	7 H 17 W 15 1/2 D	7 H 13 1/4 H Transition 17 W 15 1/2 D	5 1/2 H 17 W 15 1/2 D	7 H 17 W 15 1/2 D		
	BS1872-20TSR BS1872-20TSL	7 H 17 W 15 1/2 D	4 1/4 H 15 1/4 W 10 3/4 D Drawer Interior	8 1/2 H 15 1/4 W 10 3/4 D Drawer Interior			
	BS1854-20TFSR BS1854-20TFSL	4 1/4 H 15 1/4 W 10 3/4 D Drawer Interior	4 1/4 H 15 1/4 W 10 3/4 D Drawer Interior	8 1/2 H 15 1/4 W 10 3/4 D Drawer Interior			
	BS1872-20TFSR BS1872-20TFSL	4 1/4 H 15 1/4 W 10 3/4 D Drawer Interior	4 1/4 H 15 1/4 W 10 3/4 D Drawer Interior	8 1/2 H 15 1/4 W 10 3/4 D Drawer Interior			
	BS1854-20TDSR BS1854-20TDLSL	4 1/4 H 15 1/4 W 10 3/4 D Drawer Interior	4 1/4 H 15 1/4 W 10 3/4 D Drawer Interior	13 1/4 H 17 W 14 3/4 D Hinge Door			
	BS1854-27TOSR BS1854-27TOSL	5 1/2 H 17 W 15 1/2 D	7 H 17 W 15 1/2 D	5 1/2 H 12 H Transition 17 W 15 1/2 D	5 1/2 H 17 W 15 1/2 D	5 1/2 H 17 W 15 1/2 D	
	BS1872-27TOSR BS1872-27TOSL	5 1/2 H 17 W 15 1/2 D	7 H 17 W 15 1/2 D	5 1/2 H 12 H Transition 17 W 15 1/2 D	5 1/2 H 17 W 15 1/2 D	5 1/2 H 17 W 15 1/2 D	
	BS1854-27THDR BS1854-27THDL	5 1/2 H 17 W 15 1/2 D	7 H 17 W 15 1/2 D	15 1/2 H 12 H Transition 17 W 15 1/2 D	5 1/2 H Top Section 5 1/2 H Middle Section 7 H Bottom Section 17 W 14 3/4 D Hinge Door		

LOUNGE

BeSPACE – Compartment - Drawer Sizes (continued)

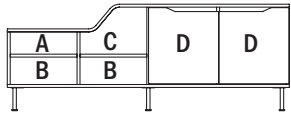
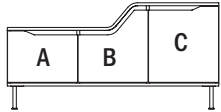
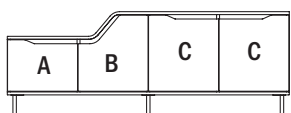
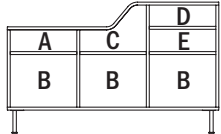
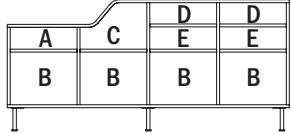
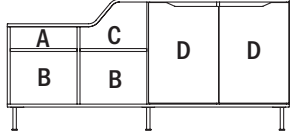
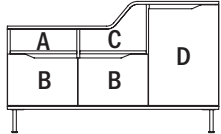
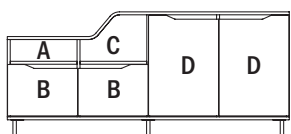
	Models	A	B	C	D	E	F
	BS1872-27TSR BS1872-27TSL	5 1/2 H 17 W 15 1/2 D	7 H 17 W 15 1/2 D	5 1/2 H 12 H Transition 17 W 15 1/2 D	5 1/2 H Top Section 5 1/2 H Middle Section 7 H Bottom Section 17 W 14 3/4 D Hinge Door		
	BS1854-27FSR BS1854-27FSL	8 1/2 H 15 1/4 W 10 3/4 D Drawer Interior	8 1/2 H 15 1/4 W 10 3/4 D Drawer Interior	5 1/2 H Top Section 5 1/2 H Middle Section 7 H Bottom Section 17 W 14 3/4 D Hinge Door			
	BS1872-27FSR BS1872-27FSL	8 1/2 H 15 1/4 W 10 3/4 D Drawer Interior	8 1/2 H 15 1/4 W 10 3/4 D Drawer Interior	5 1/2 H Top Section 5 1/2 H Middle Section 7 H Bottom Section 17 W 14 3/4 D Hinge Door			
	BS1854-33TSR BS1854-33TSL	5 1/2 H 17 W 15 1/2 D	13 1/2 H 17 W 15 1/2 D	5 1/2 H 11 3/4 H Transition 17 W 15 1/2 D	5 1/2 H 17 W 15 1/2 D	5 1/2 H 17 W 15 1/2 D	
	BS1872-33TSR BS1872-33TSL	5 1/2 H 17 W 15 1/2 D	13 1/2 H 17 W 15 1/2 D	5 1/2 H 11 3/4 H Transition 17 W 15 1/2 D	5 1/2 H 17 W 15 1/2 D	5 1/2 H 17 W 15 1/2 D	
	BS1872-33TSR BS1872-33TSL	5 1/2 H 17 W 15 1/2 D	13 1/2 H 17 W 15 1/2 D	5 1/2 H 11 3/4 H Transition 17 W 15 1/2 D	5 1/2 H Top Section 5 1/2 H Middle Section 13 1/2 H Bottom Section 17 W 14 3/4 D Hinge Door		
	BS1854-33FSR BS1854-33FSL	5 1/2 H 17 W 15 1/2 D	8 1/2 H 15 1/4 W 10 3/4 D Drawer Interior	5 1/2 H 11 3/4 H Transition 17 W 15 1/2 D	5 1/2 H Top Section 5 1/2 H Middle Section 13 1/2 H Bottom Section 17 W 14 3/4 D Hinge Door		
	BS1872-33FSR BS1872-33FSL	5 1/2 H 17 W 15 1/2 D	8 1/2 H 15 1/4 W 10 3/4 D Drawer Interior	5 1/2 H 11 3/4 H Transition 17 W 15 1/2 D	5 1/2 H Top Section 5 1/2 H Middle Section 13 1/2 H Bottom Section 17 W 14 3/4 D Hinge Door		

LOUNGE

**Typicals:
BS001**

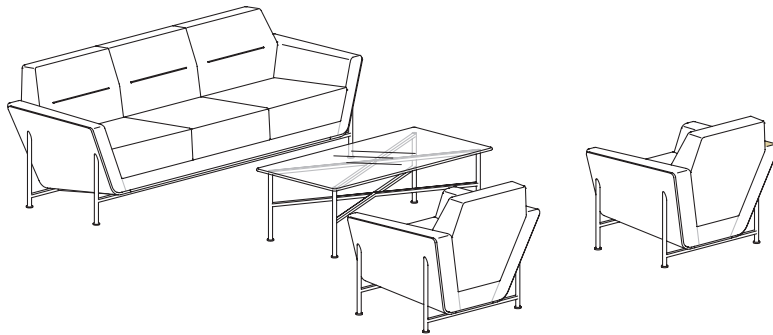
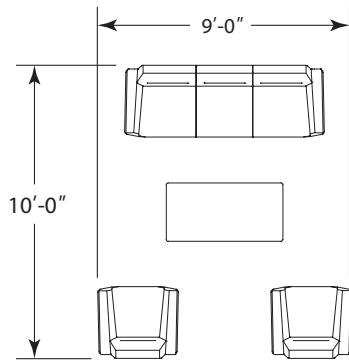

Total List: \$12,650

- Models**
 (2) BS1
 (1) BS3
 (1) BS2448GTT

BS002

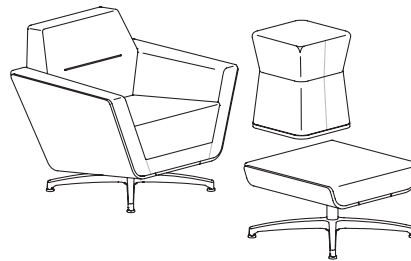
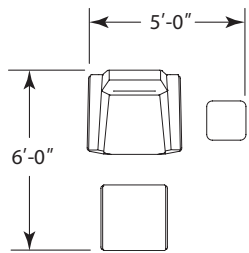

Total List: \$4,729

- Models**
 (1) BS1-S
 (1) BS140
 (1) BS230

BS003

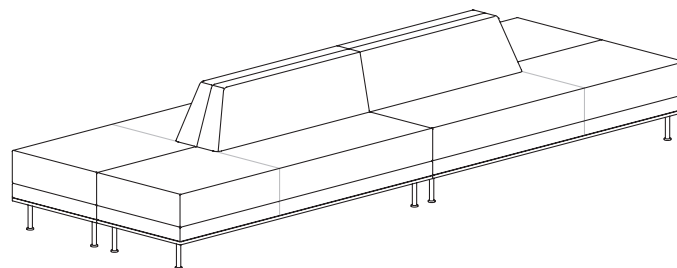
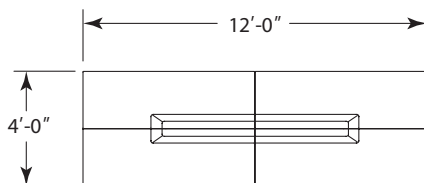

Total List: \$10,452

- Models**
 (2) BS721L
 (2) BS721R

Typicals:
BS004

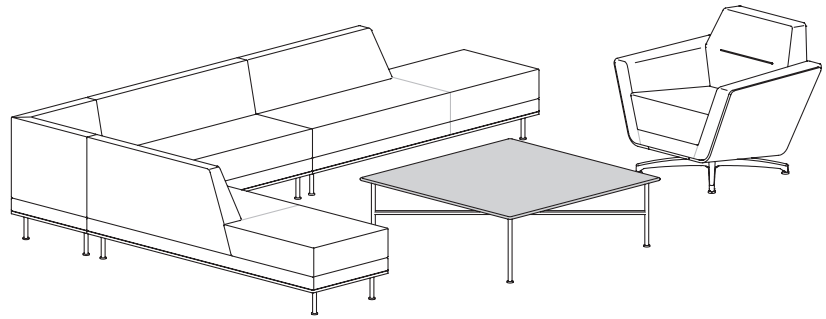
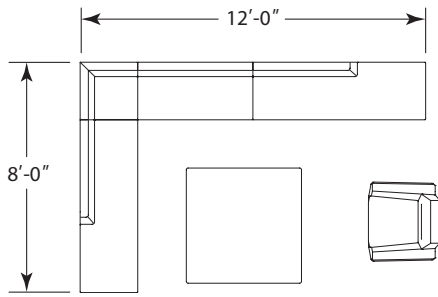

Total List: **\$13,939**

Models

- | | |
|------------|---------------|
| (1) BS1-S | (1) BS721L |
| (1) BS482 | (1) BS721R |
| (1) BS242C | (1) BS4848WTT |

BS005

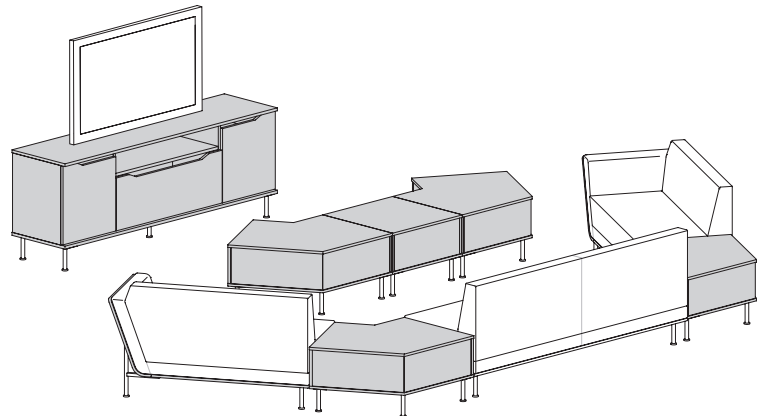
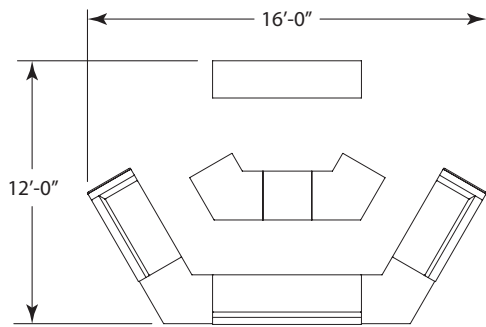

Total List: **\$15,865**

Models

- | | |
|--------------|--------------------|
| (1) BS722 | (1) BS2424SCT |
| (1) BS502L ▲ | (4) BS3636-120CT ▲ |
| (1) BS502R | (1) BS1872-27SFS |

BS006

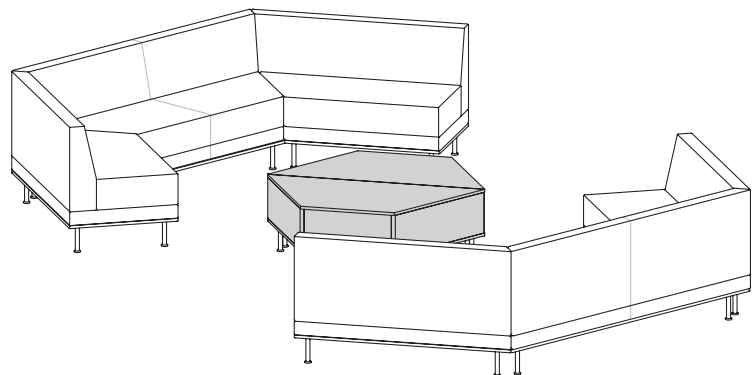
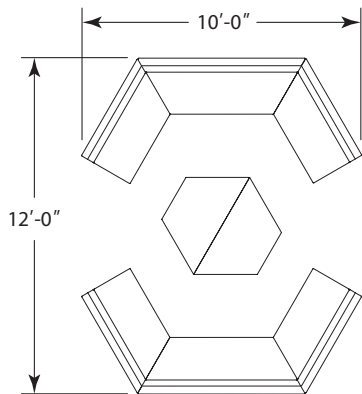

Total List: **\$14,590**

Models

- | | |
|---------------|----------------|
| (2) BS2448DCT | (2) BS482-120L |
| (2) BS722-122 | (2) BS482-120R |

LOUNGE

Typicals:
BS007

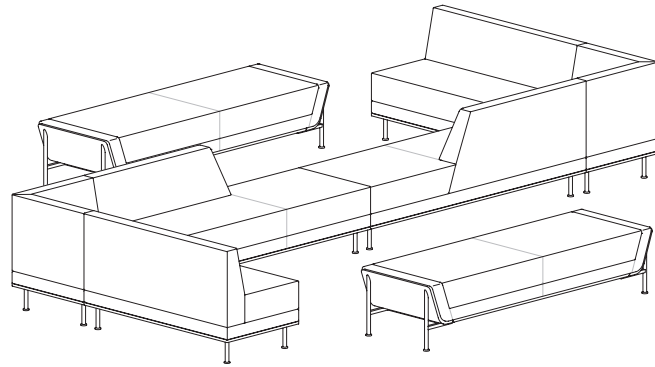
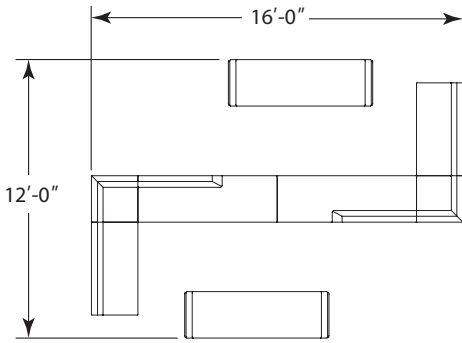

Total List: \$16,358

Models

- (2) BS242C
- (2) BS482
- (2) BS721L
- (2) BS750

BS008

LOUNGE

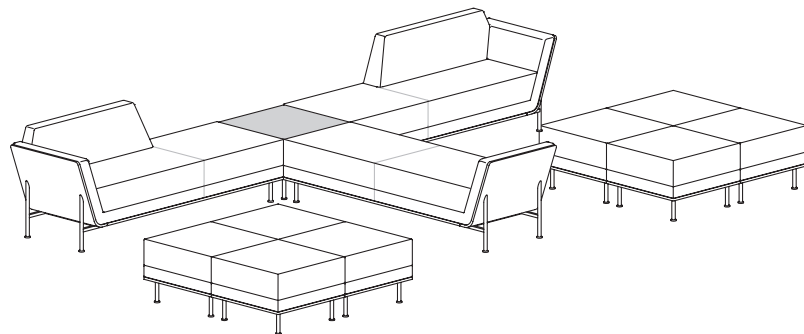
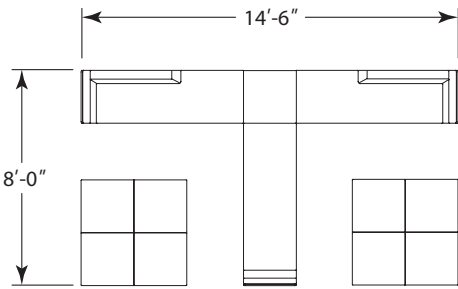

Total List: \$17,504

Models

- (1) BS740
- (1) BS741L
- (1) BS741R
- (8) BS240
- (1) BS2424SCT

**Typicals:
BS009**

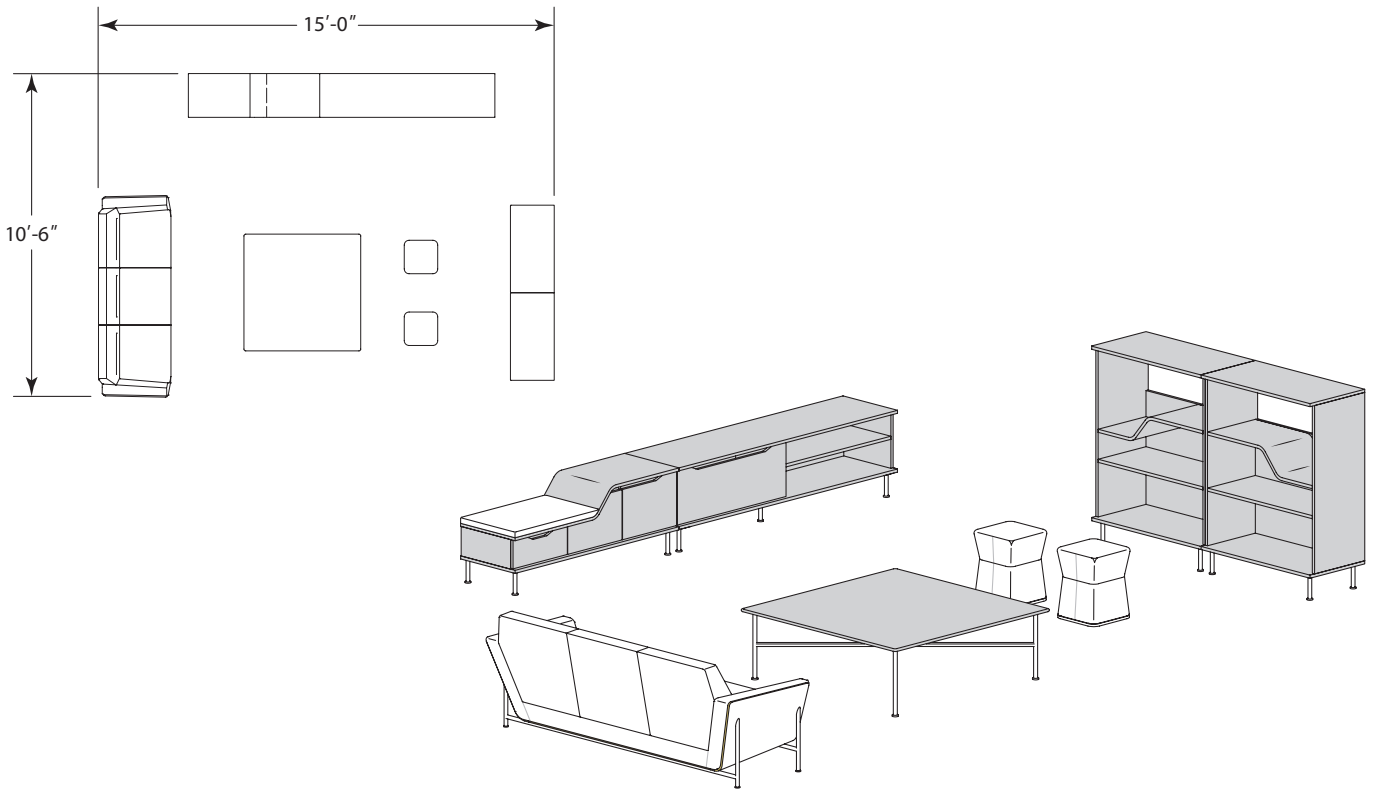

Total List: **\$17,835**

Models

- | | |
|---------------|-------------------|
| (1) BS3 | (1) BS1872-20SDWR |
| (2) BS140 | (1) BS1854-20TFSR |
| (1) BS4848WTT | (2) BS1836-480BC |

BS010





Total List: **\$8,690**

Models

- | |
|-------------------|
| (1) BS1-S |
| (1) BS230 |
| (1) BS1836-480BC |
| (1) BS1854-48SBCL |

Freestanding

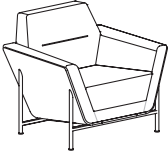
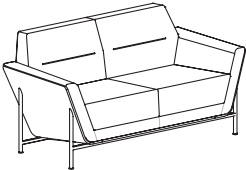
Description	Model	Specifications				List Price Per Grade	
Swivel Lounge Chair 	BS1-S · single seat lounge · four prong swivel base · bent ply shell · COM based on single fabric · multiple fabrics, see page 141 for yardage requirements	Dimensions		D	W	H	COM \$2,705 A \$2,743 B \$2,816 COL/C \$2,945 D \$3,110 E \$3,274 F \$3,531 G \$3,806 H \$4,099 I \$4,556 J \$5,107 L1 \$4,007 L2 \$4,337
		Overall	29 1/2	33 1/4	29 3/4		
		Seat	20 1/2	21 1/2	17		
		Arm			22 3/4		
		Upholstery		Shipping			
		COM Ydg	3 3/4	Ctn Wt	115		
		COL Sq Ft	75	Cu Ft	21		
Ottoman 	BS230 · four prong swivel base · bent ply shell	Dimensions		D	W	H	COM \$1,370 A \$1,380 B \$1,399 COL/C \$1,434 D \$1,478 E \$1,522 F \$1,590 G \$1,664 H \$1,741 I \$1,864 J \$2,010 L1 \$1,717 L2 \$1,805
		Overall	23	23 1/4	14		
		Upholstery		Shipping			
		COM Ydg	1	Ctn Wt	45		
		COL Sq Ft	20	Cu Ft	5		
Lounge Chair 	BS1 · single seat lounge · bent ply shell · COM based on single fabric · multiple fabrics, see page 141 for yardage requirements	Dimensions		D	W	H	COM \$2,705 A \$2,743 B \$2,816 COL/C \$2,945 D \$3,110 E \$3,274 F \$3,531 G \$3,806 H \$4,099 I \$4,556 J \$5,107 L1 \$4,007 L2 \$4,337
		Overall	29 1/2	33 1/4	29 3/4		
		Seat	20 1/2	21 1/2	17		
		Arm			22 3/4		
		Upholstery		Shipping			
		COM Ydg	3 3/4	Ctn Wt	115		
		COL Sq Ft	75	Cu Ft	21		
Settee Lounge 	BS2 · two seat lounge · bent ply shell · COM based on single fabric · multiple fabrics, see page 141 for yardage requirements	Dimensions		D	W	H	COM \$3,767 A \$3,827 B \$3,943 COL/C \$4,149 D \$4,413 E \$4,676 F \$5,087 G \$5,527 H \$5,996 I \$6,729 J \$7,609 L1 \$5,849 L2 \$6,377
		Overall	29 1/2	58 1/4	29 3/4		
		Seat	20 1/2	46 1/2	17		
		Arm			22 3/4		
		Upholstery		Shipping			
		COM Ydg	6	Ctn Wt	178		
		COL Sq Ft	120	Cu Ft	36		

LOUNGE

Freestanding

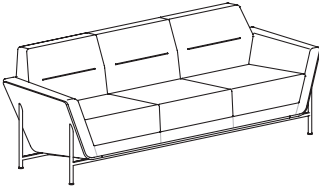
Description	1 Model	Specifications			List Price Per Grade		
Sofa Lounge 	BS3 • three seat lounge • bent ply shell • COM based on single fabric • multiple fabrics, see page 141 for yardage requirements	Dimensions	D	W	H	COM	\$4,507
		Overall	29 1/2	82 1/4	29 3/4	A	\$4,589
		Seat	20 1/2	70 1/2	17	B	\$4,750
		Arm			22 3/4	COL/C	\$5,032
		Upholstery	Shipping		D	\$5,395	
		COM Ydg	8 1/4	Ctn Wt	244	E	\$5,758
		COL Sq Ft	165	Cu Ft	50	F	\$6,323
						G	\$6,927
						H	\$7,572
						I	\$8,580
				J	\$9,790		
				L1	\$7,370		
				L2	\$8,096		

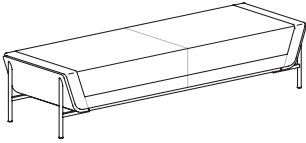
Description	1 Model	Specifications			List Price Per Grade		
Freestanding Bench 	BS750 • bent ply shell • COM based on single fabric • multiple fabrics, see page 141 for yardage requirements	Dimensions	D	W	H	COM	\$2,320
		Overall	24	74 1/2	17	A	\$2,350
		Seat	24	66 3/4	17	B	\$2,408
		Upholstery	Shipping		COL/C	\$2,511	
		COM Ydg	3	Ctn Wt	78	D	\$2,643
		COL Sq Ft	60	Cu Ft	22	E	\$2,775
						F	\$2,980
						G	\$3,200
						H	\$3,435
						I	\$3,801
				J	\$4,241		
				L1	\$3,479		
				L2	\$3,772		

To Order, Specify:

- 1 Model Number
- 2 Wood Species - Rift Cut White Oak (WK4) or Flat Cut Walnut (WA1)
- 3 Wood Finish
- 4 Metal Leg Color - Matte Black (MBK), Soft Nickel (SNK) or Stardust Silver (STS)
- 5 Fabric Selection - Vendor, Pattern and Color
 - A. Seat
 - B. Back
 - C. Deck or Deck and Arm(s)

3 Wood Finish Options:

- CLK Clear on Rift Cut White Oak
- CLW Clear on Flat Cut Walnut

5 Fabric Selection:

See a selection of graded in fabric manufacturers and patterns on pages 12-20. Contact Customer Service for additional fabric options.

Specifications:

- Wood species - Rift Cut White Oak or Flat Cut Walnut.
- 5/8" thick exterior plywood.
- Interior seating frame and support components are made from 3/4" interior grade plywood.
- Exterior feet and leg frames are fabricated from 14 guage steel tubing.
- Freestanding units have 6" thick high-resilience seat foam for durability.
- Freestanding back and arm foam is high density for comfort and durability.
- Ottoman and bench unit have a high-resilience seat foam placed onto sheet webbing for comfort and durability.

Modular

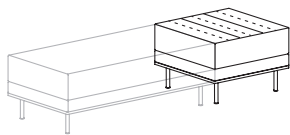
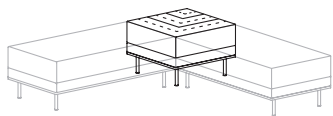
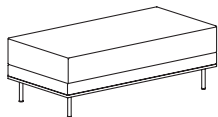
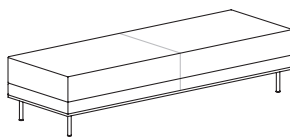
Description	Model	Specifications	List Price Per Grade																																								
24" Straight Bench 	BS240 · plywood platform · linking hardware · COM based on single fabric · multiple fabrics, see page 141 for yardage requirements · links only to other units with a square end, (cannot link to a 120° angled end)	<table border="1"> <thead> <tr> <th>Dimensions</th> <th>D</th> <th>W</th> <th>H</th> </tr> </thead> <tbody> <tr> <td>Overall</td> <td>24</td> <td>24</td> <td>16 1/2</td> </tr> <tr> <td>Seat</td> <td>24</td> <td>24</td> <td>16 1/2</td> </tr> </tbody> </table>	Dimensions	D	W	H	Overall	24	24	16 1/2	Seat	24	24	16 1/2	<table border="1"> <thead> <tr> <th colspan="2">List Price Per Grade</th> </tr> </thead> <tbody> <tr> <td>COM</td> <td>\$986</td> </tr> <tr> <td>A</td> <td>\$1,004</td> </tr> <tr> <td>B</td> <td>\$1,038</td> </tr> <tr> <td>COL/C</td> <td>\$1,098</td> </tr> <tr> <td>D</td> <td>\$1,175</td> </tr> <tr> <td>E</td> <td>\$1,252</td> </tr> <tr> <td>F</td> <td>\$1,372</td> </tr> <tr> <td>G</td> <td>\$1,500</td> </tr> <tr> <td>H</td> <td>\$1,637</td> </tr> <tr> <td>I</td> <td>\$1,851</td> </tr> <tr> <td>J</td> <td>\$2,107</td> </tr> <tr> <td>L1</td> <td>\$1,594</td> </tr> <tr> <td>L2</td> <td>\$1,748</td> </tr> </tbody> </table>	List Price Per Grade		COM	\$986	A	\$1,004	B	\$1,038	COL/C	\$1,098	D	\$1,175	E	\$1,252	F	\$1,372	G	\$1,500	H	\$1,637	I	\$1,851	J	\$2,107	L1	\$1,594	L2	\$1,748
		Dimensions	D	W	H																																						
Overall	24	24	16 1/2																																								
Seat	24	24	16 1/2																																								
List Price Per Grade																																											
COM	\$986																																										
A	\$1,004																																										
B	\$1,038																																										
COL/C	\$1,098																																										
D	\$1,175																																										
E	\$1,252																																										
F	\$1,372																																										
G	\$1,500																																										
H	\$1,637																																										
I	\$1,851																																										
J	\$2,107																																										
L1	\$1,594																																										
L2	\$1,748																																										
<table border="1"> <thead> <tr> <th>Upholstery</th> <th colspan="2">Shipping</th> </tr> </thead> <tbody> <tr> <td>COM Ydg</td> <td>1 3/4</td> <td>Ctn Wt 48</td> </tr> <tr> <td>COL Sq Ft</td> <td>35</td> <td>Cu Ft 6</td> </tr> </tbody> </table>	Upholstery	Shipping		COM Ydg	1 3/4	Ctn Wt 48	COL Sq Ft	35	Cu Ft 6																																		
Upholstery	Shipping																																										
COM Ydg	1 3/4	Ctn Wt 48																																									
COL Sq Ft	35	Cu Ft 6																																									
24" Corner Bench 	BS240C · diagonal seam · plywood platform · linking hardware · COM based on single fabric · multiple fabrics, see page 141 for yardage requirements · links only to other units with a square end, (cannot link to a 120° angled end)	<table border="1"> <thead> <tr> <th>Dimensions</th> <th>D</th> <th>W</th> <th>H</th> </tr> </thead> <tbody> <tr> <td>Overall</td> <td>24</td> <td>24</td> <td>16 1/2</td> </tr> <tr> <td>Seat</td> <td>24</td> <td>24</td> <td>16 1/2</td> </tr> </tbody> </table>	Dimensions	D	W	H	Overall	24	24	16 1/2	Seat	24	24	16 1/2	<table border="1"> <thead> <tr> <th colspan="2">List Price Per Grade</th> </tr> </thead> <tbody> <tr> <td>COM</td> <td>\$986</td> </tr> <tr> <td>A</td> <td>\$1,004</td> </tr> <tr> <td>B</td> <td>\$1,038</td> </tr> <tr> <td>COL/C</td> <td>\$1,098</td> </tr> <tr> <td>D</td> <td>\$1,175</td> </tr> <tr> <td>E</td> <td>\$1,252</td> </tr> <tr> <td>F</td> <td>\$1,372</td> </tr> <tr> <td>G</td> <td>\$1,500</td> </tr> <tr> <td>H</td> <td>\$1,637</td> </tr> <tr> <td>I</td> <td>\$1,851</td> </tr> <tr> <td>J</td> <td>\$2,107</td> </tr> <tr> <td>L1</td> <td>\$1,594</td> </tr> <tr> <td>L2</td> <td>\$1,748</td> </tr> </tbody> </table>	List Price Per Grade		COM	\$986	A	\$1,004	B	\$1,038	COL/C	\$1,098	D	\$1,175	E	\$1,252	F	\$1,372	G	\$1,500	H	\$1,637	I	\$1,851	J	\$2,107	L1	\$1,594	L2	\$1,748
		Dimensions	D	W	H																																						
Overall	24	24	16 1/2																																								
Seat	24	24	16 1/2																																								
List Price Per Grade																																											
COM	\$986																																										
A	\$1,004																																										
B	\$1,038																																										
COL/C	\$1,098																																										
D	\$1,175																																										
E	\$1,252																																										
F	\$1,372																																										
G	\$1,500																																										
H	\$1,637																																										
I	\$1,851																																										
J	\$2,107																																										
L1	\$1,594																																										
L2	\$1,748																																										
<table border="1"> <thead> <tr> <th>Upholstery</th> <th colspan="2">Shipping</th> </tr> </thead> <tbody> <tr> <td>COM Ydg</td> <td>1 3/4</td> <td>Ctn Wt 48</td> </tr> <tr> <td>COL Sq Ft</td> <td>35</td> <td>Cu Ft 6</td> </tr> </tbody> </table>	Upholstery	Shipping		COM Ydg	1 3/4	Ctn Wt 48	COL Sq Ft	35	Cu Ft 6																																		
Upholstery	Shipping																																										
COM Ydg	1 3/4	Ctn Wt 48																																									
COL Sq Ft	35	Cu Ft 6																																									
48" Straight Bench 	BS480 · plywood platform · linking hardware · COM based on single fabric · multiple fabrics, see page 141 for yardage requirements · links only to other units with a square end, (cannot link to a 120° angled end)	<table border="1"> <thead> <tr> <th>Dimensions</th> <th>D</th> <th>W</th> <th>H</th> </tr> </thead> <tbody> <tr> <td>Overall</td> <td>24</td> <td>48</td> <td>16 1/2</td> </tr> <tr> <td>Seat</td> <td>24</td> <td>48</td> <td>16 1/2</td> </tr> </tbody> </table>	Dimensions	D	W	H	Overall	24	48	16 1/2	Seat	24	48	16 1/2	<table border="1"> <thead> <tr> <th colspan="2">List Price Per Grade</th> </tr> </thead> <tbody> <tr> <td>COM</td> <td>\$1,417</td> </tr> <tr> <td>A</td> <td>\$1,437</td> </tr> <tr> <td>B</td> <td>\$1,476</td> </tr> <tr> <td>COL/C</td> <td>\$1,545</td> </tr> <tr> <td>D</td> <td>\$1,632</td> </tr> <tr> <td>E</td> <td>\$1,720</td> </tr> <tr> <td>F</td> <td>\$1,857</td> </tr> <tr> <td>G</td> <td>\$2,004</td> </tr> <tr> <td>H</td> <td>\$2,160</td> </tr> <tr> <td>I</td> <td>\$2,405</td> </tr> <tr> <td>J</td> <td>\$2,698</td> </tr> <tr> <td>L1</td> <td>\$2,111</td> </tr> <tr> <td>L2</td> <td>\$2,287</td> </tr> </tbody> </table>	List Price Per Grade		COM	\$1,417	A	\$1,437	B	\$1,476	COL/C	\$1,545	D	\$1,632	E	\$1,720	F	\$1,857	G	\$2,004	H	\$2,160	I	\$2,405	J	\$2,698	L1	\$2,111	L2	\$2,287
		Dimensions	D	W	H																																						
Overall	24	48	16 1/2																																								
Seat	24	48	16 1/2																																								
List Price Per Grade																																											
COM	\$1,417																																										
A	\$1,437																																										
B	\$1,476																																										
COL/C	\$1,545																																										
D	\$1,632																																										
E	\$1,720																																										
F	\$1,857																																										
G	\$2,004																																										
H	\$2,160																																										
I	\$2,405																																										
J	\$2,698																																										
L1	\$2,111																																										
L2	\$2,287																																										
<table border="1"> <thead> <tr> <th>Upholstery</th> <th colspan="2">Shipping</th> </tr> </thead> <tbody> <tr> <td>COM Ydg</td> <td>2</td> <td>Ctn Wt 61</td> </tr> <tr> <td>COL Sq Ft</td> <td>44</td> <td>Cu Ft 11</td> </tr> </tbody> </table>	Upholstery	Shipping		COM Ydg	2	Ctn Wt 61	COL Sq Ft	44	Cu Ft 11																																		
Upholstery	Shipping																																										
COM Ydg	2	Ctn Wt 61																																									
COL Sq Ft	44	Cu Ft 11																																									
72" Straight Bench 	BS720 · plywood platform · linking hardware · COM based on single fabric · multiple fabrics, see page 141 for yardage requirements · links only to other units with a square end, (cannot link to a 120° angled end)	<table border="1"> <thead> <tr> <th>Dimensions</th> <th>D</th> <th>W</th> <th>H</th> </tr> </thead> <tbody> <tr> <td>Overall</td> <td>24</td> <td>72</td> <td>16 1/2</td> </tr> <tr> <td>Seat</td> <td>24</td> <td>72</td> <td>16 1/2</td> </tr> </tbody> </table>	Dimensions	D	W	H	Overall	24	72	16 1/2	Seat	24	72	16 1/2	<table border="1"> <thead> <tr> <th colspan="2">List Price Per Grade</th> </tr> </thead> <tbody> <tr> <td>COM</td> <td>\$1,897</td> </tr> <tr> <td>A</td> <td>\$1,935</td> </tr> <tr> <td>B</td> <td>\$2,007</td> </tr> <tr> <td>COL/C</td> <td>\$2,136</td> </tr> <tr> <td>D</td> <td>\$2,301</td> </tr> <tr> <td>E</td> <td>\$2,466</td> </tr> <tr> <td>F</td> <td>\$2,722</td> </tr> <tr> <td>G</td> <td>\$2,997</td> </tr> <tr> <td>H</td> <td>\$3,290</td> </tr> <tr> <td>I</td> <td>\$3,748</td> </tr> <tr> <td>J</td> <td>\$4,298</td> </tr> <tr> <td>L1</td> <td>\$3,345</td> </tr> <tr> <td>L2</td> <td>\$3,711</td> </tr> </tbody> </table>	List Price Per Grade		COM	\$1,897	A	\$1,935	B	\$2,007	COL/C	\$2,136	D	\$2,301	E	\$2,466	F	\$2,722	G	\$2,997	H	\$3,290	I	\$3,748	J	\$4,298	L1	\$3,345	L2	\$3,711
		Dimensions	D	W	H																																						
Overall	24	72	16 1/2																																								
Seat	24	72	16 1/2																																								
List Price Per Grade																																											
COM	\$1,897																																										
A	\$1,935																																										
B	\$2,007																																										
COL/C	\$2,136																																										
D	\$2,301																																										
E	\$2,466																																										
F	\$2,722																																										
G	\$2,997																																										
H	\$3,290																																										
I	\$3,748																																										
J	\$4,298																																										
L1	\$3,345																																										
L2	\$3,711																																										
<table border="1"> <thead> <tr> <th>Upholstery</th> <th colspan="2">Shipping</th> </tr> </thead> <tbody> <tr> <td>COM Ydg</td> <td>3 3/4</td> <td>Ctn Wt 86</td> </tr> <tr> <td>COL Sq Ft</td> <td>83</td> <td>Cu Ft 17</td> </tr> </tbody> </table>	Upholstery	Shipping		COM Ydg	3 3/4	Ctn Wt 86	COL Sq Ft	83	Cu Ft 17																																		
Upholstery	Shipping																																										
COM Ydg	3 3/4	Ctn Wt 86																																									
COL Sq Ft	83	Cu Ft 17																																									

LOUNGE

Modular

Description

1 Model

Specifications

List Price Per Grade

50" Open Side Bench

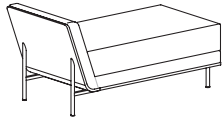

BS500

- bent ply shell
- linking hardware
- COM based on single fabric
- multiple fabrics, see page 141 for yardage requirements
- links only to other units with a square end, (cannot link to a 120° angled end)

Dimensions	D	W	H
Overall	24	49 3/4	24 3/4
Seat	24	42 3/4	16 1/2
Arm			24 3/4
Upholstery		Shipping	
COM Ydg	2 3/4	Ctn Wt	89
COL Sq Ft	60 1/2	Cu Ft	20

COM	\$2,016
A	\$2,044
B	\$2,097
COL/C	\$2,192
D	\$2,313
E	\$2,433
F	\$2,622
G	\$2,824
H	\$3,038
I	\$3,374
J	\$3,777
L1	\$3,079
L2	\$3,348

74" Open Side Bench

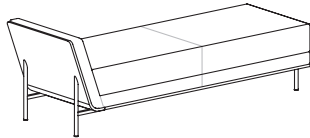

BS740

- bent ply shell
- linking hardware
- COM based on single fabric
- multiple fabrics, see page 141 for yardage requirements
- links only to other units with a square end, (cannot link to a 120° angled end)

Dimensions	D	W	H
Overall	24	73 3/4	24 3/4
Seat	24	66 3/4	16 1/2
Arm			24 3/4
Upholstery		Shipping	
COM Ydg	4 1/2	Ctn Wt	145
COL Sq Ft	99	Cu Ft	31

COM	\$2,507
A	\$2,552
B	\$2,639
COL/C	\$2,793
D	\$2,991
E	\$3,189
F	\$3,497
G	\$3,827
H	\$4,178
I	\$4,729
J	\$5,388
L1	\$4,245
L2	\$4,685

To Order, Specify:

- 1 Model Number
- 2 Wood Species - Rift Cut White Oak (WK4) or Flat Cut Walnut (WA1)
- 3 Wood Finish
- 4 Metal Leg Color - Matte Black (MBK), Soft Nickel (SNK) or Stardust Silver (STS)
- 5 Fabric Selection - Vendor, Pattern and Color
 - A. Seat
 - B. Back
 - C. Deck or Deck and Arm(s)

3 Wood Finish Options:

- CLK Clear on Rift Cut White Oak
- CLW Clear on Flat Cut Walnut



5 Fabric Selection:

See a selection of graded in fabric manufacturers and patterns on pages 12-20. Contact Customer Service for additional fabric options.

Specifications:

- Wood species - Rift Cut White Oak or Flat Cut Walnut.
- 5/8" thick exterior plywood.
- Interior seating frame and support components are made from 3/4" interior grade plywood.
- Exterior feet and leg frames are fabricated from 14 guage steel tubing.
- Modular seating units have a 3 1/2" high-resilience seat foam placed onto sheet webbing for comfort and durability.
- Modular back and arm foam is high density for comfort and durability.

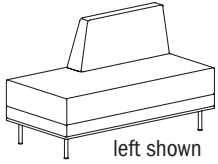
Modular

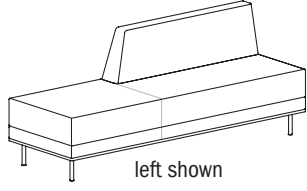
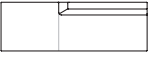
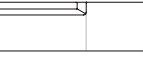
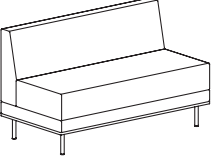
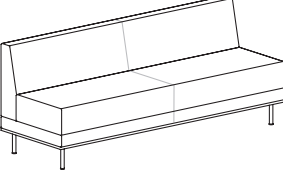
Description	Model	Specifications	List Price Per Grade												
48" Partial Back Bench  left shown  left  right	BS481R BS481L <ul style="list-style-type: none"> · plywood platform · linking hardware · COM based on single fabric · multiple fabrics, see page 141 for yardage requirements · links only to other units with a square end, (cannot link to a 120° angled end) 	<table border="1"> <thead> <tr> <th>Dimensions</th> <th>D</th> <th>W</th> <th>H</th> </tr> </thead> <tbody> <tr> <td>Overall</td> <td>24</td> <td>48</td> <td>28 1/2</td> </tr> <tr> <td>Seat</td> <td>17</td> <td>48</td> <td>16 1/2</td> </tr> </tbody> </table>	Dimensions	D	W	H	Overall	24	48	28 1/2	Seat	17	48	16 1/2	COM \$1,808 A \$1,842 B \$1,910 COL/C \$2,030 D \$2,184 E \$2,339 F \$2,578 G \$2,834 H \$3,108 I \$3,536 J \$4,048 L1 \$3,159 L2 \$3,501
		Dimensions	D	W	H										
Overall	24	48	28 1/2												
Seat	17	48	16 1/2												
<table border="1"> <thead> <tr> <th>Upholstery</th> <th colspan="3">Shipping</th> </tr> </thead> <tbody> <tr> <td>COM Ydg</td> <td>3 1/2</td> <td>Ctn Wt</td> <td>92</td> </tr> <tr> <td>COL Sq Ft</td> <td>77</td> <td>Cu Ft</td> <td>18</td> </tr> </tbody> </table>	Upholstery	Shipping			COM Ydg	3 1/2	Ctn Wt	92	COL Sq Ft	77	Cu Ft	18			
Upholstery	Shipping														
COM Ydg	3 1/2	Ctn Wt	92												
COL Sq Ft	77	Cu Ft	18												
72" Partial Back Bench  left shown  left  right	BS721R BS721L <ul style="list-style-type: none"> · plywood platform · linking hardware · COM based on single fabric · multiple fabrics, see page 141 for yardage requirements · links only to other units with a square end, (cannot link to a 120° angled end) 	<table border="1"> <thead> <tr> <th>Dimensions</th> <th>D</th> <th>W</th> <th>H</th> </tr> </thead> <tbody> <tr> <td>Overall</td> <td>24</td> <td>72</td> <td>28 1/2</td> </tr> <tr> <td>Seat</td> <td>17</td> <td>72</td> <td>16 1/2</td> </tr> </tbody> </table>	Dimensions	D	W	H	Overall	24	72	28 1/2	Seat	17	72	16 1/2	COM \$2,613 A \$2,673 B \$2,789 COL/C \$2,995 D \$3,259 E \$3,522 F \$3,933 G \$4,373 H \$4,842 I \$5,575 J \$6,455 L1 \$4,930 L2 \$5,516
		Dimensions	D	W	H										
Overall	24	72	28 1/2												
Seat	17	72	16 1/2												
<table border="1"> <thead> <tr> <th>Upholstery</th> <th colspan="3">Shipping</th> </tr> </thead> <tbody> <tr> <td>COM Ydg</td> <td>6</td> <td>Ctn Wt</td> <td>120</td> </tr> <tr> <td>COL Sq Ft</td> <td>132</td> <td>Cu Ft</td> <td>34</td> </tr> </tbody> </table>	Upholstery	Shipping			COM Ydg	6	Ctn Wt	120	COL Sq Ft	132	Cu Ft	34			
Upholstery	Shipping														
COM Ydg	6	Ctn Wt	120												
COL Sq Ft	132	Cu Ft	34												
48" Straight Bench with Back 	BS482 <ul style="list-style-type: none"> · plywood platform · linking hardware · COM based on single fabric · multiple fabrics, see page 141 for yardage requirements · links only to other units with a square end, (cannot link to a 120° angled end) 	<table border="1"> <thead> <tr> <th>Dimensions</th> <th>D</th> <th>W</th> <th>H</th> </tr> </thead> <tbody> <tr> <td>Overall</td> <td>24</td> <td>48</td> <td>28 1/2</td> </tr> <tr> <td>Seat</td> <td>17</td> <td>48</td> <td>16 1/2</td> </tr> </tbody> </table>	Dimensions	D	W	H	Overall	24	48	28 1/2	Seat	17	48	16 1/2	COM \$1,715 A \$1,750 B \$1,818 COL/C \$1,938 D \$2,092 E \$2,246 F \$2,486 G \$2,742 H \$3,016 I \$3,443 J \$3,956 L1 \$3,066 L2 \$3,409
		Dimensions	D	W	H										
Overall	24	48	28 1/2												
Seat	17	48	16 1/2												
<table border="1"> <thead> <tr> <th>Upholstery</th> <th colspan="3">Shipping</th> </tr> </thead> <tbody> <tr> <td>COM Ydg</td> <td>3 1/2</td> <td>Ctn Wt</td> <td>102</td> </tr> <tr> <td>COL Sq Ft</td> <td>77</td> <td>Cu Ft</td> <td>18</td> </tr> </tbody> </table>	Upholstery	Shipping			COM Ydg	3 1/2	Ctn Wt	102	COL Sq Ft	77	Cu Ft	18			
Upholstery	Shipping														
COM Ydg	3 1/2	Ctn Wt	102												
COL Sq Ft	77	Cu Ft	18												
72" Straight Bench with Back 	BS722 <ul style="list-style-type: none"> · plywood platform · linking hardware · COM based on single fabric · multiple fabrics, see page 141 for yardage requirements · links only to other units with a square end, (cannot link to a 120° angled end) 	<table border="1"> <thead> <tr> <th>Dimensions</th> <th>D</th> <th>W</th> <th>H</th> </tr> </thead> <tbody> <tr> <td>Overall</td> <td>24</td> <td>72</td> <td>28 1/2</td> </tr> <tr> <td>Seat</td> <td>17</td> <td>72</td> <td>16 1/2</td> </tr> </tbody> </table>	Dimensions	D	W	H	Overall	24	72	28 1/2	Seat	17	72	16 1/2	COM \$2,557 A \$2,624 B \$2,756 COL/C \$2,987 D \$3,284 E \$3,581 F \$4,042 G \$4,538 H \$5,065 I \$5,890 J \$6,879 L1 \$5,164 L2 \$5,823
		Dimensions	D	W	H										
Overall	24	72	28 1/2												
Seat	17	72	16 1/2												
<table border="1"> <thead> <tr> <th>Upholstery</th> <th colspan="3">Shipping</th> </tr> </thead> <tbody> <tr> <td>COM Ydg</td> <td>6 3/4</td> <td>Ctn Wt</td> <td>137</td> </tr> <tr> <td>COL Sq Ft</td> <td>149</td> <td>Cu Ft</td> <td>34</td> </tr> </tbody> </table>	Upholstery	Shipping			COM Ydg	6 3/4	Ctn Wt	137	COL Sq Ft	149	Cu Ft	34			
Upholstery	Shipping														
COM Ydg	6 3/4	Ctn Wt	137												
COL Sq Ft	149	Cu Ft	34												

LOUNGE

Modular

Description

1 Model

Specifications

List Price Per Grade

50" Chaise Bench with Partial Back

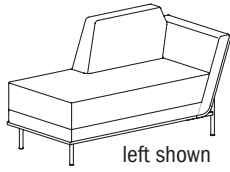

left shown

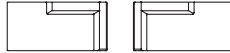

left

right

BS501R
BS501L

- bent ply shell
- linking hardware
- COM based on single fabric
- multiple fabrics, see page 141 for yardage requirements
- links only to other units with a square end, (cannot link to a 120° angled end)

Dimensions	D	W	H
Overall	24	49 3/4	28 1/2
Seat	17	42 3/4	16 1/2
Arm			24 3/4
Upholstery		Shipping	
COM Ydg	4 1/2	Ctn Wt	111
COL Sq Ft	99	Cu Ft	24

COM	\$2,314
A	\$2,359
B	\$2,446
COL/C	\$2,600
D	\$2,798
E	\$2,996
F	\$3,304
G	\$3,633
H	\$3,985
I	\$4,535
J	\$5,195
L1	\$4,051
L2	\$4,491

74" Chaise Bench with Partial Back

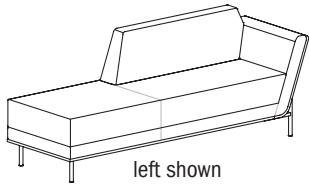

left shown

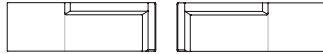

left

right

BS741R
BS741L

- bent ply shell
- linking hardware
- COM based on single fabric
- multiple fabrics, see page 141 for yardage requirements
- links only to other units with a square end, (cannot link to a 120° angled end)

Dimensions	D	W	H
Overall	24	73 3/4	28 1/2
Seat	17	66 3/4	16 1/2
Arm			24 3/4
Upholstery		Shipping	
COM Ydg	6 3/4	Ctn Wt	173
COL Sq Ft	149	Cu Ft	34

COM	\$3,101
A	\$3,168
B	\$3,300
COL/C	\$3,531
D	\$3,828
E	\$4,125
F	\$4,586
G	\$5,081
H	\$5,609
I	\$6,434
J	\$7,423
L1	\$5,708
L2	\$6,367

To Order, Specify:

- 1 Model Number
- 2 Wood Species - Rift Cut White Oak (WK4) or Flat Cut Walnut (WA1)
- 3 Wood Finish
- 4 Metal Leg Color - Matte Black (MBK), Soft Nickel (SNK) or Stardust Silver (STS)
- 5 Fabric Selection - Vendor, Pattern and Color
 - A. Seat
 - B. Back
 - C. Deck or Deck and Arm(s)

3 Wood Finish Options:

- CLK Clear on Rift Cut White Oak
CLW Clear on Flat Cut Walnut

5 Fabric Selection:

See a selection of graded in fabric manufacturers and patterns on pages 12-20. Contact Customer Service for additional fabric options.

Specifications:

- Wood species - Rift Cut White Oak or Flat Cut Walnut.
- 5/8" thick exterior plywood.
- Interior seating frame and support components are made from 3/4" interior grade plywood.
- Exterior feet and leg frames are fabricated from 14 guage steel tubing.
- Modular seating units have a 3 1/2" high-resilience seat foam placed onto sheet webbing for comfort and durability.
- Modular back and arm foam is high density for comfort and durability.

Modular

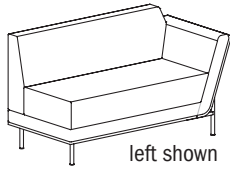
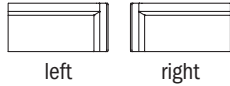
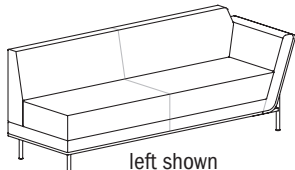
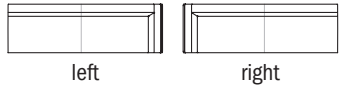
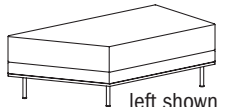
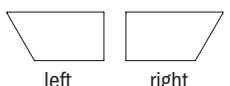
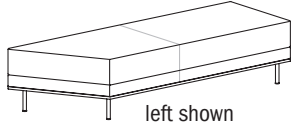
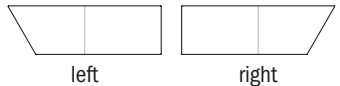
Description	Model	Specifications	List Price Per Grade																												
<p>50" Open Side Bench with Back</p>  <p>left shown</p>  <p>left right</p>	<p>BS502R BS502L</p> <ul style="list-style-type: none"> · bent ply shell · linking hardware · COM based on single fabric · multiple fabrics, see page 141 for yardage requirements · links only to other units with a square end, (cannot link to a 120° angled end) 	<table border="1"> <thead> <tr> <th>Dimensions</th> <th>D</th> <th>W</th> <th>H</th> </tr> </thead> <tbody> <tr> <td>Overall</td> <td>24</td> <td>49 ³/₄</td> <td>28 ¹/₂</td> </tr> <tr> <td>Seat</td> <td>17</td> <td>42 ³/₄</td> <td>16 ¹/₂</td> </tr> <tr> <td>Arm</td> <td></td> <td></td> <td>24 ³/₄</td> </tr> <tr> <th colspan="2">Upholstery</th> <th colspan="2">Shipping</th> </tr> <tr> <td>COM Ydg</td> <td>4 ¹/₂</td> <td>Ctn Wt</td> <td>122</td> </tr> <tr> <td>COL Sq Ft</td> <td>99</td> <td>Cu Ft</td> <td>24</td> </tr> </tbody> </table>	Dimensions	D	W	H	Overall	24	49 ³ / ₄	28 ¹ / ₂	Seat	17	42 ³ / ₄	16 ¹ / ₂	Arm			24 ³ / ₄	Upholstery		Shipping		COM Ydg	4 ¹ / ₂	Ctn Wt	122	COL Sq Ft	99	Cu Ft	24	<p>COM \$2,509 A \$2,554 B \$2,641 COL/C \$2,796 D \$2,993 E \$3,191 F \$3,499 G \$3,829 H \$4,181 I \$4,731 J \$5,390 L1 \$4,247 L2 \$4,687</p>
Dimensions	D	W	H																												
Overall	24	49 ³ / ₄	28 ¹ / ₂																												
Seat	17	42 ³ / ₄	16 ¹ / ₂																												
Arm			24 ³ / ₄																												
Upholstery		Shipping																													
COM Ydg	4 ¹ / ₂	Ctn Wt	122																												
COL Sq Ft	99	Cu Ft	24																												
<p>74" Open Side Bench with Back</p>  <p>left shown</p>  <p>left right</p>	<p>BS742R BS742L</p> <ul style="list-style-type: none"> · bent ply shell · linking hardware · COM based on single fabric · multiple fabrics, see page 141 for yardage requirements · links only to other units with a square end, (cannot link to a 120° angled end) 	<table border="1"> <thead> <tr> <th>Dimensions</th> <th>D</th> <th>W</th> <th>H</th> </tr> </thead> <tbody> <tr> <td>Overall</td> <td>24</td> <td>73 ³/₄</td> <td>28 ¹/₂</td> </tr> <tr> <td>Seat</td> <td>17</td> <td>66 ³/₄</td> <td>16 ¹/₂</td> </tr> <tr> <td>Arm</td> <td></td> <td></td> <td>24 ³/₄</td> </tr> <tr> <th colspan="2">Upholstery</th> <th colspan="2">Shipping</th> </tr> <tr> <td>COM Ydg</td> <td>7 ³/₄</td> <td>Ctn Wt</td> <td>188</td> </tr> <tr> <td>COL Sq Ft</td> <td>171</td> <td>Cu Ft</td> <td>34</td> </tr> </tbody> </table>	Dimensions	D	W	H	Overall	24	73 ³ / ₄	28 ¹ / ₂	Seat	17	66 ³ / ₄	16 ¹ / ₂	Arm			24 ³ / ₄	Upholstery		Shipping		COM Ydg	7 ³ / ₄	Ctn Wt	188	COL Sq Ft	171	Cu Ft	34	<p>COM \$3,200 A \$3,276 B \$3,428 COL/C \$3,693 D \$4,034 E \$4,375 F \$4,905 G \$5,473 H \$6,079 I \$7,026 J \$8,162 L1 \$6,192 L2 \$6,949</p>
Dimensions	D	W	H																												
Overall	24	73 ³ / ₄	28 ¹ / ₂																												
Seat	17	66 ³ / ₄	16 ¹ / ₂																												
Arm			24 ³ / ₄																												
Upholstery		Shipping																													
COM Ydg	7 ³ / ₄	Ctn Wt	188																												
COL Sq Ft	171	Cu Ft	34																												
<p>48" Angled Bench</p>  <p>left shown</p>  <p>left right</p>	<p>BS480-120R BS480-120L</p> <ul style="list-style-type: none"> · plywood platform · linking hardware · COM based on single fabric · multiple fabrics, see page 141 for yardage requirements · square end links only to other units with a square end · 120° angled end links only to other units with a 120° angled end 	<table border="1"> <thead> <tr> <th>Dimensions</th> <th>D</th> <th>W</th> <th>H</th> </tr> </thead> <tbody> <tr> <td>Overall</td> <td>24</td> <td>48</td> <td>16 ¹/₂</td> </tr> <tr> <td>Seat</td> <td>24</td> <td>48</td> <td>16 ¹/₂</td> </tr> <tr> <th colspan="2">Upholstery</th> <th colspan="2">Shipping</th> </tr> <tr> <td>COM Ydg</td> <td>2</td> <td>Ctn Wt</td> <td>59</td> </tr> <tr> <td>COL Sq Ft</td> <td>44</td> <td>Cu Ft</td> <td>11</td> </tr> </tbody> </table>	Dimensions	D	W	H	Overall	24	48	16 ¹ / ₂	Seat	24	48	16 ¹ / ₂	Upholstery		Shipping		COM Ydg	2	Ctn Wt	59	COL Sq Ft	44	Cu Ft	11	<p>COM \$1,489 A \$1,509 B \$1,548 COL/C \$1,617 D \$1,705 E \$1,793 F \$1,929 G \$2,076 H \$2,233 I \$2,477 J \$2,770 L1 \$2,183 L2 \$2,360</p>				
Dimensions	D	W	H																												
Overall	24	48	16 ¹ / ₂																												
Seat	24	48	16 ¹ / ₂																												
Upholstery		Shipping																													
COM Ydg	2	Ctn Wt	59																												
COL Sq Ft	44	Cu Ft	11																												
<p>72" Angled Bench</p>  <p>left shown</p>  <p>left right</p>	<p>BS720-120R BS720-120L</p> <ul style="list-style-type: none"> · plywood platform · linking hardware · COM based on single fabric · multiple fabrics, see page 141 for yardage requirements · square end links only to other units with a square end · 120° angled end links only to other units with a 120° angled end 	<table border="1"> <thead> <tr> <th>Dimensions</th> <th>D</th> <th>W</th> <th>H</th> </tr> </thead> <tbody> <tr> <td>Overall</td> <td>24</td> <td>72</td> <td>16 ¹/₂</td> </tr> <tr> <td>Seat</td> <td>24</td> <td>72</td> <td>16 ¹/₂</td> </tr> <tr> <th colspan="2">Upholstery</th> <th colspan="2">Shipping</th> </tr> <tr> <td>COM Ydg</td> <td>3 ³/₄</td> <td>Ctn Wt</td> <td>82</td> </tr> <tr> <td>COL Sq Ft</td> <td>83</td> <td>Cu Ft</td> <td>17</td> </tr> </tbody> </table>	Dimensions	D	W	H	Overall	24	72	16 ¹ / ₂	Seat	24	72	16 ¹ / ₂	Upholstery		Shipping		COM Ydg	3 ³ / ₄	Ctn Wt	82	COL Sq Ft	83	Cu Ft	17	<p>COM \$1,973 A \$2,011 B \$2,084 COL/C \$2,213 D \$2,378 E \$2,543 F \$2,799 G \$3,074 H \$3,367 I \$3,825 J \$4,375 L1 \$3,421 L2 \$3,788</p>				
Dimensions	D	W	H																												
Overall	24	72	16 ¹ / ₂																												
Seat	24	72	16 ¹ / ₂																												
Upholstery		Shipping																													
COM Ydg	3 ³ / ₄	Ctn Wt	82																												
COL Sq Ft	83	Cu Ft	17																												

LOUNGE

Modular

Description

1 Model

Specifications

List Price Per Grade

50" Angled Open Side Bench

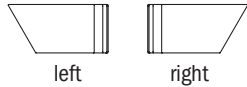
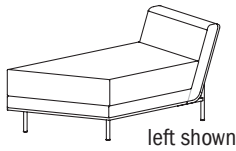

- BS500-120R**
BS500-120L
- bent ply shell
 - linking hardware
 - COM based on single fabric
 - multiple fabrics, see page 141 for yardage requirements
 - links only to other units with a 120° angled end, (cannot link to a square end)

Dimensions	D	W	H
Overall	24	49 3/4	24 3/4
Seat	24	42 3/4	16 1/2
Arm			24 3/4
Upholstery		Shipping	
COM Ydg	2 3/4	Ctn Wt	84
COL Sq Ft	60 1/2	Cu Ft	20

- COM \$2,061
A \$2,088
B \$2,141
COL/C \$2,236
D \$2,357
E \$2,477
F \$2,666
G \$2,868
H \$3,082
I \$3,418
J \$3,821
L1 \$3,123
L2 \$3,392

74" Angled Open Side Bench

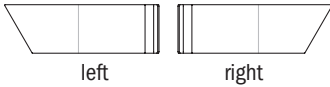
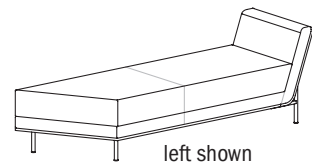

- BS740-120R**
BS740-120L
- bent ply shell
 - linking hardware
 - COM based on single fabric
 - multiple fabrics, see page 141 for yardage requirements
 - links only to other units with a 120° angled end, (cannot link to a square end)

Dimensions	D	W	H
Overall	24	73 3/4	24 3/4
Seat	24	66 3/4	16 1/2
Arm			24 3/4
Upholstery		Shipping	
COM Ydg	4 1/2	Ctn Wt	141
COL Sq Ft	99	Cu Ft	31

- COM \$2,562
A \$2,608
B \$2,695
COL/C \$2,849
D \$3,047
E \$3,245
F \$3,553
G \$3,882
H \$4,234
I \$4,784
J \$5,444
L1 \$4,300
L2 \$4,740

To Order, Specify:

- 1 Model Number
- 2 Wood Species - Rift Cut White Oak (WK4) or Flat Cut Walnut (WA1)
- 3 Wood Finish
- 4 Metal Leg Color - Matte Black (MBK), Soft Nickel (SNK) or Stardust Silver (STS)
- 5 Fabric Selection - Vendor, Pattern and Color
A. Seat
B. Back
C. Deck or Deck and Arm(s)

3 Wood Finish Options:

- CLK Clear on Rift Cut White Oak
CLW Clear on Flat Cut Walnut







5 Fabric Selection:

See a selection of graded in fabric manufacturers and patterns on pages 12-20. Contact Customer Service for additional fabric options.

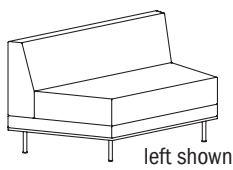
Specifications:

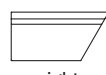
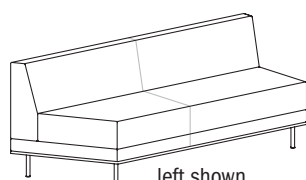
- Wood species - Rift Cut White Oak or Flat Cut Walnut.
- 5/8" thick exterior plywood.
- Interior seating frame and support components are made from 3/4" interior grade plywood.
- Exterior feet and leg frames are fabricated from 14 guage steel tubing.
- Modular seating units have a 3 1/2" high-resilience seat foam placed onto sheet webbing for comfort and durability.
- Modular back and arm foam is high density for comfort and durability.

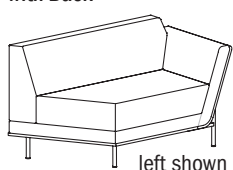
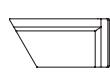
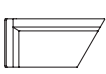
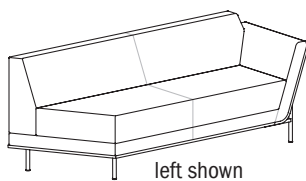
Modular

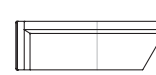
Description	Model	Specifications	List Price Per Grade																												
 <p>left shown</p>  <p>left</p>  <p>right</p>	BS482-120R BS482-120L <ul style="list-style-type: none"> plywood platform linking hardware COM based on single fabric multiple fabrics, see page 141 for yardage requirements square end links only to other units with a square end 120° angled end links only to other units with a 120° angled end 	<table border="1"> <thead> <tr> <th>Dimensions</th> <th>D</th> <th>W</th> <th>H</th> </tr> </thead> <tbody> <tr> <td>Overall</td> <td>24</td> <td>48</td> <td>28 1/2</td> </tr> <tr> <td>Seat</td> <td>17</td> <td>44</td> <td>16 1/2</td> </tr> <tr> <th colspan="2">Upholstery</th> <th colspan="2">Shipping</th> </tr> <tr> <td>COM Ydg</td> <td>3 1/2</td> <td>Ctn Wt</td> <td>99</td> </tr> <tr> <td>COL Sq Ft</td> <td>77</td> <td>Cu Ft</td> <td>18</td> </tr> </tbody> </table>	Dimensions	D	W	H	Overall	24	48	28 1/2	Seat	17	44	16 1/2	Upholstery		Shipping		COM Ydg	3 1/2	Ctn Wt	99	COL Sq Ft	77	Cu Ft	18	COM \$1,783 A \$1,818 B \$1,886 COL/C \$2,006 D \$2,160 E \$2,315 F \$2,554 G \$2,810 H \$3,084 I \$3,512 J \$4,024 L1 \$3,135 L2 \$3,477				
		Dimensions	D	W	H																										
Overall	24	48	28 1/2																												
Seat	17	44	16 1/2																												
Upholstery		Shipping																													
COM Ydg	3 1/2	Ctn Wt	99																												
COL Sq Ft	77	Cu Ft	18																												
 <p>left shown</p>  <p>left</p>  <p>right</p>	BS722-120R BS722-120L <ul style="list-style-type: none"> plywood platform linking hardware COM based on single fabric multiple fabrics, see page 141 for yardage requirements square end links only to other units with a square end 120° angled end links only to other units with a 120° angled end 	<table border="1"> <thead> <tr> <th>Dimensions</th> <th>D</th> <th>W</th> <th>H</th> </tr> </thead> <tbody> <tr> <td>Overall</td> <td>24</td> <td>72</td> <td>28 1/2</td> </tr> <tr> <td>Seat</td> <td>17</td> <td>68</td> <td>16 1/2</td> </tr> <tr> <th colspan="2">Upholstery</th> <th colspan="2">Shipping</th> </tr> <tr> <td>COM Ydg</td> <td>6 3/4</td> <td>Ctn Wt</td> <td>133</td> </tr> <tr> <td>COL Sq Ft</td> <td>149</td> <td>Cu Ft</td> <td>34</td> </tr> </tbody> </table>	Dimensions	D	W	H	Overall	24	72	28 1/2	Seat	17	68	16 1/2	Upholstery		Shipping		COM Ydg	6 3/4	Ctn Wt	133	COL Sq Ft	149	Cu Ft	34	COM \$2,642 A \$2,709 B \$2,841 COL/C \$3,072 D \$3,369 E \$3,666 F \$4,127 G \$4,623 H \$5,150 I \$5,975 J \$6,964 L1 \$5,249 L2 \$5,908				
		Dimensions	D	W	H																										
Overall	24	72	28 1/2																												
Seat	17	68	16 1/2																												
Upholstery		Shipping																													
COM Ydg	6 3/4	Ctn Wt	133																												
COL Sq Ft	149	Cu Ft	34																												
 <p>left shown</p>  <p>left</p>  <p>right</p>	BS502-120R BS502-120L <ul style="list-style-type: none"> bent ply shell linking hardware COM based on single fabric multiple fabrics, see page 141 for yardage requirements links only to other units with a 120° angled end, (cannot link to a square end) 	<table border="1"> <thead> <tr> <th>Dimensions</th> <th>D</th> <th>W</th> <th>H</th> </tr> </thead> <tbody> <tr> <td>Overall</td> <td>24</td> <td>49 3/4</td> <td>28 1/2</td> </tr> <tr> <td>Seat</td> <td>17</td> <td>39</td> <td>16 1/2</td> </tr> <tr> <td>Arm</td> <td></td> <td></td> <td>24 3/4</td> </tr> <tr> <th colspan="2">Upholstery</th> <th colspan="2">Shipping</th> </tr> <tr> <td>COM Ydg</td> <td>4 1/2</td> <td>Ctn Wt</td> <td>119</td> </tr> <tr> <td>COL Sq Ft</td> <td>99</td> <td>Cu Ft</td> <td>24</td> </tr> </tbody> </table>	Dimensions	D	W	H	Overall	24	49 3/4	28 1/2	Seat	17	39	16 1/2	Arm			24 3/4	Upholstery		Shipping		COM Ydg	4 1/2	Ctn Wt	119	COL Sq Ft	99	Cu Ft	24	COM \$2,373 A \$2,419 B \$2,506 COL/C \$2,660 D \$2,858 E \$3,056 F \$3,364 G \$3,693 H \$4,045 I \$4,595 J \$5,255 L1 \$4,111 L2 \$4,551
		Dimensions	D	W	H																										
Overall	24	49 3/4	28 1/2																												
Seat	17	39	16 1/2																												
Arm			24 3/4																												
Upholstery		Shipping																													
COM Ydg	4 1/2	Ctn Wt	119																												
COL Sq Ft	99	Cu Ft	24																												
 <p>left shown</p>  <p>left</p>  <p>right</p>	BS742-120R BS742-120L <ul style="list-style-type: none"> bent ply shell linking hardware COM based on single fabric multiple fabrics, see page 141 for yardage requirements links only to other units with a 120° angled end, (cannot link to a square end) 	<table border="1"> <thead> <tr> <th>Dimensions</th> <th>D</th> <th>W</th> <th>H</th> </tr> </thead> <tbody> <tr> <td>Overall</td> <td>24</td> <td>73 3/4</td> <td>28 1/2</td> </tr> <tr> <td>Seat</td> <td>17</td> <td>63</td> <td>16 1/2</td> </tr> <tr> <td>Arm</td> <td></td> <td></td> <td>24 3/4</td> </tr> <tr> <th colspan="2">Upholstery</th> <th colspan="2">Shipping</th> </tr> <tr> <td>COM Ydg</td> <td>7 3/4</td> <td>Ctn Wt</td> <td>184</td> </tr> <tr> <td>COL Sq Ft</td> <td>171</td> <td>Cu Ft</td> <td>34</td> </tr> </tbody> </table>	Dimensions	D	W	H	Overall	24	73 3/4	28 1/2	Seat	17	63	16 1/2	Arm			24 3/4	Upholstery		Shipping		COM Ydg	7 3/4	Ctn Wt	184	COL Sq Ft	171	Cu Ft	34	COM \$3,236 A \$3,312 B \$3,463 COL/C \$3,729 D \$4,069 E \$4,410 F \$4,941 G \$5,509 H \$6,115 I \$7,062 J \$8,198 L1 \$6,228 L2 \$6,985
		Dimensions	D	W	H																										
Overall	24	73 3/4	28 1/2																												
Seat	17	63	16 1/2																												
Arm			24 3/4																												
Upholstery		Shipping																													
COM Ydg	7 3/4	Ctn Wt	184																												
COL Sq Ft	171	Cu Ft	34																												

LOUNGE

Modular

Description

1 Model

Specifications

List Price Per Grade

48" Dual Angled Bench

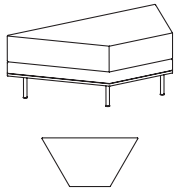

BS480-122

- plywood platform
- linking hardware
- COM based on single fabric
- multiple fabrics, see page 141 for yardage requirements
- links only to other units with a 120° angled end, (cannot link to a square end)

Dimensions	D	W	H
Overall	24	48	16 1/2
Seat	24	48	16 1/2
Upholstery		Shipping	
COM Ydg	2	Ctn Wt	56
COL Sq Ft	44	Cu Ft	11

- COM \$1,496
- A \$1,516
- B \$1,554
- COL/C \$1,624
- D \$1,711
- E \$1,799
- F \$1,936
- G \$2,083
- H \$2,239
- I \$2,484
- J \$2,777
- L1 \$2,268
- L2 \$2,464

72" Dual Angled Bench

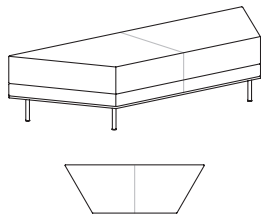

BS720-122

- plywood platform
- linking hardware
- COM based on single fabric
- multiple fabrics, see page 141 for yardage requirements
- links only to other units with a 120° angled end, (cannot link to a square end)

Dimensions	D	W	H
Overall	24	72	16 1/2
Seat	24	72	16 1/2
Upholstery		Shipping	
COM Ydg	3 3/4	Ctn Wt	78
COL Sq Ft	83	Cu Ft	17

- COM \$1,980
- A \$2,018
- B \$2,090
- COL/C \$2,219
- D \$2,384
- E \$2,549
- F \$2,805
- G \$3,080
- H \$3,373
- I \$3,831
- J \$4,381
- L1 \$3,428
- L2 \$3,794

To Order, Specify:

- 1 Model Number
- 2 Wood Species - Rift Cut White Oak (WK4) or Flat Cut Walnut (WA1)
- 3 Wood Finish
- 4 Metal Leg Color - Matte Black (MBK), Soft Nickel (SNK) or Stardust Silver (STS)
- 5 Fabric Selection - Vendor, Pattern and Color
 - A. Seat
 - B. Back
 - C. Deck or Deck and Arm(s)

3 Wood Finish Options:

- CLK Clear on Rift Cut White Oak
- CLW Clear on Flat Cut Walnut

5 Fabric Selection:

See a selection of graded in fabric manufacturers and patterns on pages 12-20. Contact Customer Service for additional fabric options.

Specifications:

- Wood species - Rift Cut White Oak or Flat Cut Walnut.
- 5/8" thick exterior plywood.
- Interior seating frame and support components are made from 3/4" interior grade plywood.
- Exterior feet and leg frames are fabricated from 14 guage steel tubing.
- Modular seating units have a 3 1/2" high-resilience seat foam placed onto sheet webbing for comfort and durability.
- Modular back and arm foam is high density for comfort and durability.

Modular

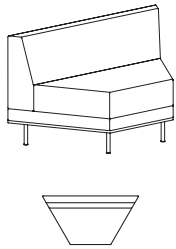
Description	Model	Specifications				List Price Per Grade	
48" Dual Angled Bench with Back 	BS482-122 · plywood platform · linking hardware · COM based on single fabric · multiple fabrics, see page 141 for yardage requirements · links only to other units with a 120° angled end, (cannot link to a square end)	Dimensions		D	W	H	COM \$1,783
		Overall	24	48	28 1/2		
		Seat	17	40	16 1/2		B \$1,886
		Upholstery		Shipping			COL/C \$2,006
		COM Ydg	3 1/2	Ctn Wt	96		D \$2,160
		COL Sq Ft	77	Cu Ft	18		E \$2,315
							F \$2,554
							G \$2,810
							H \$3,084
							I \$3,512
							J \$4,024
							L1 \$3,135
							L2 \$3,477

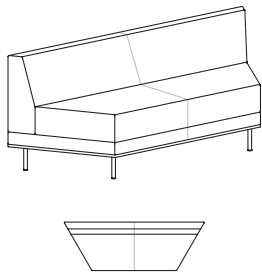
72" Dual Angled Bench with Back 	BS722-122 · plywood platform · linking hardware · COM based on single fabric · multiple fabrics, see page 141 for yardage requirements · links only to other units with a 120° angled end, (cannot link to a square end)	Dimensions		D	W	H	COM \$2,619
		Overall	24	72	28 1/2		
		Seat	17	64	16 1/2		B \$2,818
		Upholstery		Shipping			COL/C \$3,049
		COM Ydg	6 3/4	Ctn Wt	129		D \$3,346
		COL Sq Ft	149	Cu Ft	34		E \$3,643
							F \$4,104
							G \$4,599
							H \$5,127
							I \$5,952
							J \$6,941
							L1 \$5,226
							L2 \$5,885

Modular

Description

1 Model

Specifications

List Price Per Grade

120° Connecting Bench

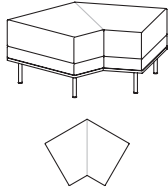

BS240-122

- plywood platform
- linking hardware
- COM based on single fabric
- multiple fabrics, see page 141 for yardage requirements
- links only to other units with a square end, (cannot link to a 120° angled end)
- allows flat end modular units to complete 120° turn

Dimensions	D	W	H
Overall	32 1/2	41 1/4	16 1/2
Seat	24	41 1/4	16 1/2
Upholstery		Shipping	
COM Ydg	2 1/2	Ctn Wt	65
COL Sq Ft	50	Cu Ft	12

COM	\$1,445
A	\$1,470
B	\$1,519
COL/C	\$1,605
D	\$1,715
E	\$1,824
F	\$1,995
G	\$2,179
H	\$2,375
I	\$2,680
J	\$3,047
L1	\$2,314
L2	\$2,533

120° Connecting Bench with Back

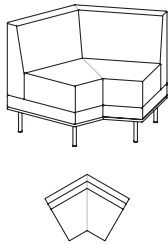

BS242-122

- plywood platform
- linking hardware
- COM based on single fabric
- multiple fabrics, see page 141 for yardage requirements
- links only to other units with a square end, (cannot link to a 120° angled end)
- allows flat end modular units to complete 120° turn

Dimensions	D	W	H
Overall	32 1/2	41 1/4	28 1/2
Seat	17	35	16 1/2
Upholstery		Shipping	
COM Ydg	4 1/2	Ctn Wt	102
COL Sq Ft	90	Cu Ft	20

COM	\$1,916
A	\$1,961
B	\$2,048
COL/C	\$2,202
D	\$2,400
E	\$2,598
F	\$2,906
G	\$3,236
H	\$3,587
I	\$4,137
J	\$4,797
L1	\$3,478
L2	\$3,873

To Order, Specify:

- 1 Model Number
- 2 Wood Species - Rift Cut White Oak (WK4) or Flat Cut Walnut (WA1)
- 3 Wood Finish
- 4 Metal Leg Color - Matte Black (MBK), Soft Nickel (SNK) or Stardust Silver (STS)
- 5 Fabric Selection - Vendor, Pattern and Color
 - A. Seat
 - B. Back
 - C. Deck or Deck and Arm(s)

3 Wood Finish Options:

- CLK Clear on Rift Cut White Oak
- CLW Clear on Flat Cut Walnut

5 Fabric Selection:

See a selection of graded in fabric manufacturers and patterns on pages 12-20. Contact Customer Service for additional fabric options.

Specifications:

- Wood species - Rift Cut White Oak or Flat Cut Walnut.
- 5/8" thick exterior plywood.
- Interior seating frame and support components are made from 3/4" interior grade plywood.
- Exterior feet and leg frames are fabricated from 14 guage steel tubing.
- Modular seating units have a 3 1/2" high-resilience seat foam placed onto sheet webbing for comfort and durability.
- Modular back and arm foam is high density for comfort and durability.

Modular

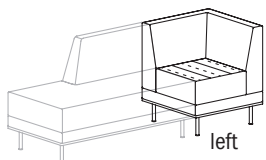
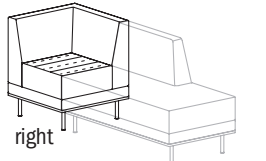
Description	Model	Specifications	List Price Per Grade																										
Corner Bench with Back  left  right	BS242R BS242L <ul style="list-style-type: none"> · plywood platform · linking hardware · COM based on single fabric · multiple fabrics, see page 141 for yardage requirements · links only to other units with a square end, (cannot link to a 120° angled end) 	<table border="1"> <thead> <tr> <th>Dimensions</th> <th>D</th> <th>W</th> <th>H</th> </tr> </thead> <tbody> <tr> <td>Overall</td> <td>24</td> <td>24</td> <td>28 1/2</td> </tr> <tr> <td>Seat</td> <td>17</td> <td>17</td> <td>16 1/2</td> </tr> </tbody> </table>	Dimensions	D	W	H	Overall	24	24	28 1/2	Seat	17	17	16 1/2	<table border="1"> <thead> <tr> <th colspan="2">Upholstery</th> <th colspan="2">Shipping</th> </tr> </thead> <tbody> <tr> <td>COM Ydg</td> <td>3 1/4</td> <td>Ctn Wt</td> <td>75</td> </tr> <tr> <td>COL Sq Ft</td> <td>65</td> <td>Cu Ft</td> <td>11</td> </tr> </tbody> </table>	Upholstery		Shipping		COM Ydg	3 1/4	Ctn Wt	75	COL Sq Ft	65	Cu Ft	11		
		Dimensions	D	W	H																								
Overall	24	24	28 1/2																										
Seat	17	17	16 1/2																										
Upholstery		Shipping																											
COM Ydg	3 1/4	Ctn Wt	75																										
COL Sq Ft	65	Cu Ft	11																										
			<table border="1"> <tbody> <tr><td>COM</td><td>\$1,531</td></tr> <tr><td>A</td><td>\$1,564</td></tr> <tr><td>B</td><td>\$1,627</td></tr> <tr><td>COL/C</td><td>\$1,738</td></tr> <tr><td>D</td><td>\$1,881</td></tr> <tr><td>E</td><td>\$2,025</td></tr> <tr><td>F</td><td>\$2,246</td></tr> <tr><td>G</td><td>\$2,485</td></tr> <tr><td>H</td><td>\$2,739</td></tr> <tr><td>I</td><td>\$3,136</td></tr> <tr><td>J</td><td>\$3,612</td></tr> <tr><td>L1</td><td>\$2,660</td></tr> <tr><td>L2</td><td>\$2,946</td></tr> </tbody> </table>	COM	\$1,531	A	\$1,564	B	\$1,627	COL/C	\$1,738	D	\$1,881	E	\$2,025	F	\$2,246	G	\$2,485	H	\$2,739	I	\$3,136	J	\$3,612	L1	\$2,660	L2	\$2,946
COM	\$1,531																												
A	\$1,564																												
B	\$1,627																												
COL/C	\$1,738																												
D	\$1,881																												
E	\$2,025																												
F	\$2,246																												
G	\$2,485																												
H	\$2,739																												
I	\$3,136																												
J	\$3,612																												
L1	\$2,660																												
L2	\$2,946																												

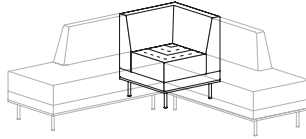
Corner Bench with Back 	BS242C <ul style="list-style-type: none"> · plywood platform · linking hardware · diagonal seam · COM based on single fabric · multiple fabrics, see page 141 for yardage requirements · links only to other units with a square end, (cannot link to a 120° angled end) 	<table border="1"> <thead> <tr> <th>Dimensions</th> <th>D</th> <th>W</th> <th>H</th> </tr> </thead> <tbody> <tr> <td>Overall</td> <td>24</td> <td>24</td> <td>28 1/2</td> </tr> <tr> <td>Seat</td> <td>17</td> <td>17</td> <td>16 1/2</td> </tr> </tbody> </table>	Dimensions	D	W	H	Overall	24	24	28 1/2	Seat	17	17	16 1/2	<table border="1"> <thead> <tr> <th colspan="2">Upholstery</th> <th colspan="2">Shipping</th> </tr> </thead> <tbody> <tr> <td>COM Ydg</td> <td>3 1/4</td> <td>Ctn Wt</td> <td>75</td> </tr> <tr> <td>COL Sq Ft</td> <td>65</td> <td>Cu Ft</td> <td>11</td> </tr> </tbody> </table>	Upholstery		Shipping		COM Ydg	3 1/4	Ctn Wt	75	COL Sq Ft	65	Cu Ft	11		
		Dimensions	D	W	H																								
Overall	24	24	28 1/2																										
Seat	17	17	16 1/2																										
Upholstery		Shipping																											
COM Ydg	3 1/4	Ctn Wt	75																										
COL Sq Ft	65	Cu Ft	11																										
			<table border="1"> <tbody> <tr><td>COM</td><td>\$1,531</td></tr> <tr><td>A</td><td>\$1,564</td></tr> <tr><td>B</td><td>\$1,627</td></tr> <tr><td>COL/C</td><td>\$1,738</td></tr> <tr><td>D</td><td>\$1,881</td></tr> <tr><td>E</td><td>\$2,025</td></tr> <tr><td>F</td><td>\$2,246</td></tr> <tr><td>G</td><td>\$2,485</td></tr> <tr><td>H</td><td>\$2,739</td></tr> <tr><td>I</td><td>\$3,136</td></tr> <tr><td>J</td><td>\$3,612</td></tr> <tr><td>L1</td><td>\$2,660</td></tr> <tr><td>L2</td><td>\$2,946</td></tr> </tbody> </table>	COM	\$1,531	A	\$1,564	B	\$1,627	COL/C	\$1,738	D	\$1,881	E	\$2,025	F	\$2,246	G	\$2,485	H	\$2,739	I	\$3,136	J	\$3,612	L1	\$2,660	L2	\$2,946
COM	\$1,531																												
A	\$1,564																												
B	\$1,627																												
COL/C	\$1,738																												
D	\$1,881																												
E	\$2,025																												
F	\$2,246																												
G	\$2,485																												
H	\$2,739																												
I	\$3,136																												
J	\$3,612																												
L1	\$2,660																												
L2	\$2,946																												

Modular

Description	1 Model	Specifications				List Price Per Grade	
Upholstered Pod 	BS140 • plywood platform • nylon glides • COM based on single fabric • multiple fabrics, see page 141 for yardage requirements • casters not available	Dimensions		D	W	H	COM \$654
		Overall		13 1/2	13 1/2	18	A \$669
		Seat		13 1/2	13 1/2	18	B \$698
		Upholstery		Shipping		COL/C \$749	
		COM Ydg		1 1/2	Ctn Wt	22	D \$815
		COL Sq Ft		27	Cu Ft	3	E \$881
							F \$984
					G \$1,094		
					H \$1,211		
					I \$1,395		
					J \$1,614		
					L1 \$1,174		
					L2 \$1,307		

Description	1 Model	Specifications				List Price Per Grade	
Upholstered Table 	BS140W • plywood top • plywood platform • nylon glides • COM based on single fabric • multiple fabrics, see page 141 for yardage requirements • casters not available	Dimensions		D	W	H	COM \$720
		Overall		13 1/2	13 1/2	21 1/4	A \$735
		Upholstery		Shipping		COL/C \$815	
		COM Ydg		1 1/2	Ctn Wt	25	D \$881
		COL Sq Ft		27	Cu Ft	3	E \$948
							F \$1,050
							G \$1,160
					H \$1,277		
					I \$1,461		
					J \$1,680		
					L1 \$1,241		
					L2 \$1,373		

To Order, Specify:

- 1 Model Number
- 2 Wood Species - Rift Cut White Oak (WK4) or Flat Cut Walnut (WA1)
- 3 Wood Finish
- 4 Metal Leg Color - Matte Black (MBK), Soft Nickel (SNK) or Stardust Silver (STS)
- 5 Fabric Selection - Vendor, Pattern and Color
 - A. Seat
 - B. Back
 - C. Deck or Deck and Arm(s)

3 Wood Finish Options:

- CLK Clear on Rift Cut White Oak
- CLW Clear on Flat Cut Walnut



5 Fabric Selection:

See a selection of graded in fabric manufacturers and patterns on pages 12-20. Contact Customer Service for additional fabric options.

Specifications:

- Wood species - Rift Cut White Oak or Flat Cut Walnut.
- 5/8" thick exterior plywood.
- Interior seating frame and support components are made from 3/4" interior grade plywood.
- Exterior feet and leg frames are fabricated from 14 guage steel tubing.
- Modular seating units have a 3 1/2" high-resilience seat foam placed onto sheet webbing for comfort and durability.
- Modular back and arm foam is high density for comfort and durability.

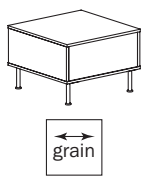
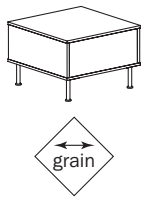
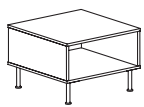
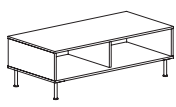
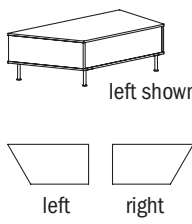
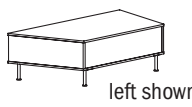
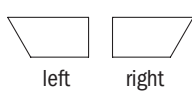
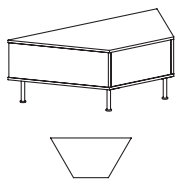
Modular

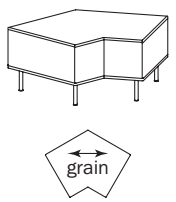
Description	D	W	H	CTN WT	CU FT	① Model	List Price
Square Table 	24	24	16 1/4	40	5	BS2424SCT	\$907
<ul style="list-style-type: none"> · straight grain top · no opening · linking hardware · power center (EC22) available on front and/or back panel, specify and add \$504 list each 							
Square Corner Table 	24	24	16 1/4	40	5	BS2424DCT	\$965
<ul style="list-style-type: none"> · diagonal grain top · no opening · for corner installation · linking hardware · power center (EC22) available on back panel(s), specify and add \$504 list each 							
Open Square Table 	24	24	16 1/4	40	5	BS2424OCT	\$867
<ul style="list-style-type: none"> · straight grain top · open front · linking hardware 							
Coffee Table 	24	48	16 1/4	60	9	BS2448OCT	\$1,076
<ul style="list-style-type: none"> · straight grain top · open front · linking hardware 							
48" Single Angled Table 	24	48	16 1/4	60	9	BS2448SCTR	\$1,162
<ul style="list-style-type: none"> · one square end, one 120° angled end · no opening · linking hardware · power center (EC22) available on front and/or back panel, specify and add \$504 list each · square end links only to other square end units · 120° angled end links only to other 120° angled end units 							
 left shown  left right	24	48	16 1/4	60	9	BS2448SCTL	\$1,162
48" Dual Angled Corner Table 	24	48	16 1/4	60	9	BS2448DCT	\$1,110
<ul style="list-style-type: none"> · two 120° angled ends · no opening · linking hardware · power center (EC22) available on front and/or back panel, specify and add \$504 list each · 120° angled ends link only to other 120° angled end units 							
							
120° Connecting Table 	36	36	16 1/4	50	9	BS3636-12OCT	\$1,248
<ul style="list-style-type: none"> · diagonal grain top · no opening · linking hardware · power center (EC22) available on front and back panel(s), specify and add \$504 list each · optional EC22 on non-linking sides · square ends link only to other square end units (cannot link to 120° angled ends) 							

LOUNGE

Freestanding

Description	D	W	H	CTN WT	CU FT	① Model	List Price
Side Wood Table	20	20	16 1/4	25	5	BS2020WTT	\$2,515



- 5/8" thick plywood top
- metal frame

Rectangular Wood Coffee Table	24	48	16 1/4	35	14	BS2448WTT	\$2,646
-------------------------------	----	----	--------	----	----	-----------	---------



- 5/8" thick plywood top
- metal frame

Square Wood Coffee Table	48	48	16 1/4	55	26	BS4848WTT	\$2,762
--------------------------	----	----	--------	----	----	-----------	---------

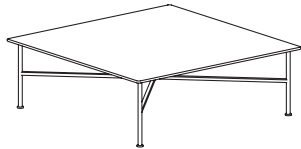

- 5/8" thick plywood top
- metal frame

Glass Side Table	20	20	16 1/4	30	5	BS2020GTT	\$2,549
------------------	----	----	--------	----	---	-----------	---------



- 1/2" thick tempered glass top
- metal frame

Rectangular Glass Coffee Table	24	48	16 1/4	40	14	BS2448GTT	\$2,733
--------------------------------	----	----	--------	----	----	-----------	---------

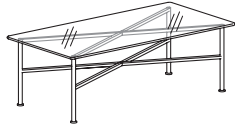

- 1/2" thick tempered glass top
- metal frame

Square Glass Coffee Table	48	48	16 1/4	60	26	BS4848GTT	\$2,963
---------------------------	----	----	--------	----	----	-----------	---------

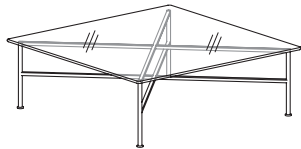

- 1/2" thick tempered glass top
- metal frame

To Order, Specify:

- ① Model Number
- ② Wood Species - Rift Cut White Oak (WK4) or Flat Cut Walnut (WA1)
- ③ Wood Finish
- ④ Glass Color - Clear (GTC01) or Smoke (GTC04)
- ⑤ Metal Leg Color - Matte Black (MBK), Soft Nickel (SNK) or Stardust Silver (STS)
- ⑥ Optional Power Center (see page 137)

③ Wood Finish Options:

- CLK Clear on Rift Cut White Oak
CLW Clear on Flat Cut Walnut

Specifications:

- Wood species - Rift Cut White Oak or Flat Cut Walnut.
- Linking Tables have 3/4" thick plywood tops
- Exterior feet and leg frames are fabricated from 14 gauge steel tubing and 14 gauge flat stock.

Modular

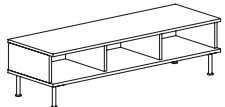
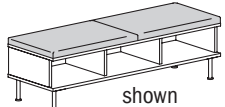
Description	D	W	H	CTN WT	CU FT	① Model	List Price No Cushion	List Price With Cushion
Bench Height Credenza Open Storage	18	54	14 1/2	80	7	BS1854-16SOS	\$1,308	COM \$1,709
 <ul style="list-style-type: none"> · three open sections · linking hardware · optional attached 1 1/2" thick cushion · interior dividers have a wire pass thru · rectangular back center grommet available, specify and add \$79 list · 24" wire manager included for field installation · com ydg: 1 1/2 								A \$1,725 B \$1,753 COL/C \$1,804 D \$1,871 E \$1,937 F \$2,040 G \$2,149 H \$2,266 I \$2,450 J \$2,670 L1 \$2,230 L2 \$2,362
 <p>shown with cushion</p>								

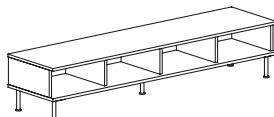
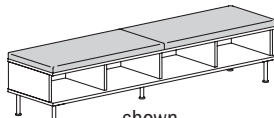
Bench Height Credenza Open Storage	18	72	14 1/2	90	9	BS1872-16SOS	\$1,562	COM \$2,068
 <ul style="list-style-type: none"> · four open sections · linking hardware · optional attached 1 1/2" thick cushion · interior dividers have a wire pass thru · rectangular back center grommet available, specify and add \$79 list · 24" wire manager included for field installation · com ydg: 1 3/4 								A \$2,086 B \$2,119 COL/C \$2,179 D \$2,257 E \$2,334 F \$2,453 G \$2,581 H \$2,719 I \$2,932 J \$3,188 L1 \$2,676 L2 \$2,829
 <p>shown with cushion</p>								

Modular

Description	D	W	H	CTN WT	CU FT	① Model	List Price No Cushion	List Price With Cushion
Bench Height Credenza with Drawers	18	54	14 1/2	100	7	BS1854-16SDWR	\$1,551	COM \$1,952
	18	54	14 1/2	100	7	BS1854-16SDWL	\$1,551	A \$1,968 B \$1,997 COL/C \$2,048 D \$2,114 E \$2,180 F \$2,283 G \$2,392 H \$2,510 I \$2,694 J \$2,913 L1 \$2,473 L2 \$2,606
Bench Height Credenza with Drawers	18	72	14 1/2	100	9	BS1872-16SDWR	\$1,788	COM \$2,294
	18	72	14 1/2	100	9	BS1872-16SDWL	\$1,788	A \$2,312 B \$2,345 COL/C \$2,405 D \$2,483 E \$2,559 F \$2,679 G \$2,807 H \$2,945 I \$3,158 J \$3,414 L1 \$2,902 L2 \$3,055
Bench Height Credenza with Drawers	18	72	14 1/2	120	9	BS1872-16SFS	\$2,029	COM \$2,535
								A \$2,553 B \$2,587 COL/C \$2,646 D \$2,724 E \$2,801 F \$2,921 G \$3,049 H \$3,186 I \$3,399 J \$3,656 L1 \$3,143 L2 \$3,296

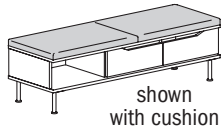
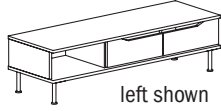

- one open section, two drawers
- linking hardware
- optional attached 1 1/2" thick cushion
- interior dividers have a wire pass thru
- rectangular back center grommet available, specify and add \$79 list
- 24" wire manager included for field installation
- com ydg: 1 1/2

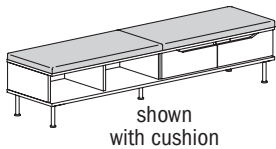
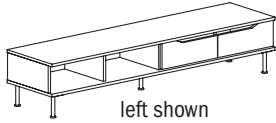

- two open sections, two drawers
- linking hardware
- optional attached 1 1/2" thick cushion
- interior dividers have a wire pass thru
- rectangular back center grommet available, specify and add \$79 list
- 24" wire manager included for field installation
- com ydg: 1 3/4

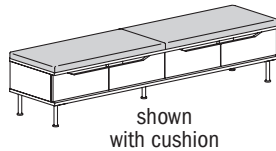
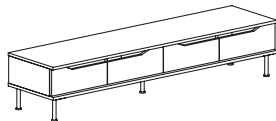

- four drawers
- linking hardware
- optional attached 1 1/2" thick cushion
- interior dividers have a wire pass thru
- rectangular back center grommet available, specify and add \$79 list
- 24" wire manager included for field installation
- com ydg: 1 3/4

To Order, Specify:

- ① Model Number
- ② Wood Species - Rift Cut White Oak (WK4) or Flat Cut Walnut (WA1)
- ③ Wood Finish
- ④ Drawer Front Optional Paint Color
- ⑤ Metal Leg Color - Matte Black (MBK), Soft Nickel (SNK) or Stardust Silver (STS)
- ⑥ Fabric Selection - Vendor, Pattern and Color
- ⑦ Optional Back (Black) Grommet (see page 134)

③ Wood Finish Options:

- CLK Clear on Rift Cut White Oak
- CLW Clear on Flat Cut Walnut

④ Paint Color Options:

- BKD Backdrop
- BFX Black Fox
- BWH Bright White
- CGP Cargo Pants
- CHT Chatroom
- FRR French Roast
- GRV Greek Villa
- NET Network Gray
- NWH Nonchalant White
- STM Storm
- TRC Tricorn Black

⑥ Fabric Selection:

See a selection of graded in fabric manufacturers and patterns on pages 12-20. Contact Customer Service for additional fabric options.

Specifications:

- Wood species - Rift Cut White Oak or Flat Cut Walnut.
- 3/4" thick plywood tops
- Exterior feet and leg frames are fabricated from 14 gauge steel tubing and 14 gauge flat stock.

Modular

Description	D	W	H	CTN WT	CU FT	Model	List Price
Low Height Credenza Open Storage	18	54	20	120	11	BS1854-20SOSR	\$1,362
	18	54	20	120	11	BS1854-20SOSL	\$1,362

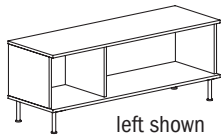

- open cabinet
- linking hardware
- interior dividers have a wire pass thru
- rectangular back center grommet available, specify and add \$79 list
- 24" wire manager included for field installation

Low Height Credenza Open Storage	18	72	20	110	15	BS1872-20SOS	\$1,764
-------------------------------------	----	----	----	-----	----	--------------	---------

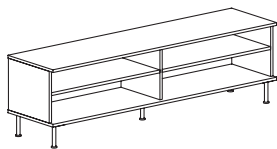

- two fixed shelves
- linking hardware
- interior dividers have a wire pass thru
- rectangular back center grommet available, specify and add \$79 list
- 24" wire manager included for field installation

Low Height Credenza with Drawer	18	54	20	140	11	BS1854-20SDWR	\$1,571
	18	54	20	140	11	BS1854-20SDWL	\$1,571

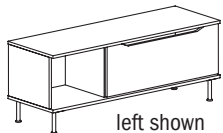

- one open cabinet, one storage drawer
- linking hardware
- interior dividers have a wire pass thru
- rectangular back center grommet available, specify and add \$79 list
- 24" wire manager included for field installation

Low Height Credenza with Drawer	18	72	20	130	15	BS1872-20SDWR	\$1,887
	18	72	20	130	15	BS1872-20SDWL	\$1,887

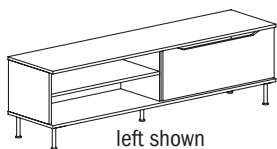

- one open cabinet with one fixed shelf, one storage drawer
- linking hardware
- interior dividers have a wire pass thru
- rectangular back center grommet available, specify and add \$79 list
- 24" wire manager included for field installation

Low Height Credenza with Two Drawers	18	72	20	150	15	BS1872-20SFS	\$2,004
---	----	----	----	-----	----	--------------	---------

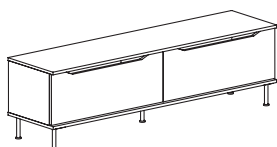

- two storage drawers
- linking hardware
- interior dividers have a wire pass thru
- rectangular back center grommet available, specify and add \$79 list
- 24" wire manager included for field installation

LOUNGE

Modular

Description	D	W	H	CTN WT	CU FT	① Model	List Price
Standard Height Credenza	18	54	27	130	15	BS1854-27SOSR	\$1,604
Open Storage	18	54	27	130	15	BS1854-27SOSL	\$1,604

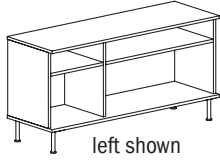

- open cabinet, two fixed shelves
- linking hardware
- interior dividers have a wire pass thru
- rectangular back center grommet available, specify and add \$79 list
- 24" wire manager included for field installation

Standard Height Credenza	18	72	27	130	20	BS1872-27SOS	\$1,962
Open Storage							

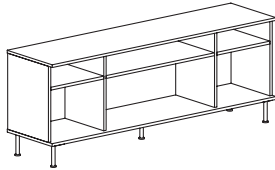

- open cabinet, three fixed shelves
- linking hardware
- interior dividers have a wire pass thru
- rectangular back center grommet available, specify and add \$79 list
- 24" wire manager included for field installation

Standard Height Credenza	18	54	27	140	15	BS1854-27SDWR	\$1,816
with Drawer	18	54	27	140	15	BS1854-27SDWL	\$1,816

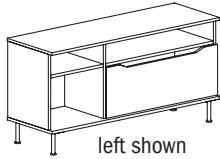

- open cabinet with fixed shelf, storage drawer with open compartment
- linking hardware
- interior dividers have a wire pass thru
- rectangular back center grommet available, specify and add \$79 list
- 24" wire manager included for field installation

To Order, Specify:

- ① Model Number
- ② Wood Species - Rift Cut White Oak (WK4) or Flat Cut Walnut (WA1)
- ③ Wood Finish
- ④ Drawer Front Optional Paint Color
- ⑤ Metal Leg Color - Matte Black (MBK), Soft Nickel (SNK) or Stardust Silver (STS)
- ⑥ Optional Back (Black) Grommet (see page 134)

③ Wood Finish Options:

- CLK Clear on Rift Cut White Oak
 CLW Clear on Flat Cut Walnut

④ Paint Color Options:

- | | |
|------------------|----------------------|
| BKD Backdrop | GRV Greek Villa |
| BFX Black Fox | NET Network Gray |
| BWH Bright White | NWH Nonchalant White |
| CGP Cargo Pants | STM Storm |
| CHT Chatroom | TRC Tricorn Black |
| FRR French Roast | |

Specifications:

- Wood species - Rift Cut White Oak or Flat Cut Walnut.
- 3/4" thick plywood tops
- Exterior feet and leg frames are fabricated from 14 guage steel tubing and 14 guage flat stock.

Modular

Description	D	W	H	CTN WT	CU FT	Model	List Price
Standard Height Storage Credenza	18	54	27	150	15	BS1854-27SFSR	\$1,900
	18	54	27	150	15	BS1854-27SFSL	\$1,900

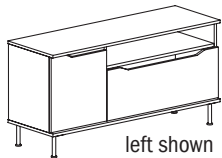

- one door with fixed shelf, storage drawer with open compartment
- linking hardware
- interior dividers have a wire pass thru
- rectangular back center grommet available, specify and add \$79 list
- 24" wire manager included for field installation

Standard Height Storage Credenza	18	72	27	160	20	BS1872-27SSR	\$2,319
	18	72	27	160	20	BS1872-27SSL	\$2,319

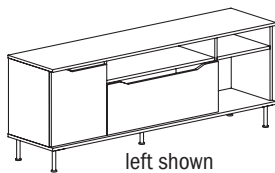

- one door with fixed shelf, storage drawer with open compartment
- open storage one fixed shelf
- linking hardware
- interior dividers have a wire pass thru
- rectangular back center grommet available, specify and add \$79 list
- 24" wire manager included for field installation

Standard Height Storage Credenza	18	72	27	170	20	BS1872-27SFS	\$2,391
-------------------------------------	----	----	----	-----	----	---------------------	----------------

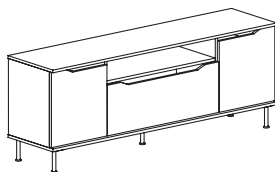

- one door with fixed shelf, one drawer with open compartment, one door with fixed shelf
- linking hardware
- interior dividers have a wire pass thru
- rectangular back center grommet available, specify and add \$79 list
- 24" wire manager included for field installation

LOUNGE

Modular

Description	D	W	H	CTN WT	CU FT	① Model	List Price
Tall Credenza Open Storage	18	54	33	140	19	BS1854-33SOSR	\$1,850
	18	54	33	140	19	BS1854-33SOSL	\$1,850

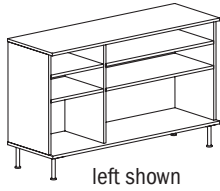

- open cabinet, four fixed shelves
- linking hardware
- interior dividers have a wire pass thru
- rectangular back center grommet available, specify and add \$79 list
- 24" wire manager included for field installation

Tall Credenza Open Storage	18	72	33	140	25	BS1872-33SOS	\$2,147
----------------------------	----	----	----	-----	----	--------------	---------

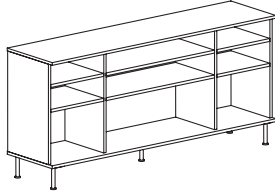

- open cabinet, six fixed shelves
- linking hardware
- interior dividers have a wire pass thru
- rectangular back center grommet available, specify and add \$79 list
- 24" wire manager included for field installation

Tall Storage Credenza	18	54	33	160	19	BS1854-33SFSR	\$2,161
	18	54	33	160	19	BS1854-33SFSL	\$2,161

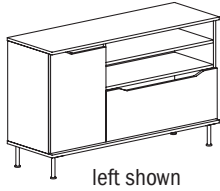

- one door with two fixed shelves, one storage drawer with two open compartments
- linking hardware
- interior dividers have a wire pass thru
- rectangular back center grommet available, specify and add \$79 list
- 24" wire manager included for field installation

Tall Storage Credenza	18	72	33	170	25	BS1872-33SSR	\$2,453
	18	72	33	170	25	BS1872-33SSL	\$2,453

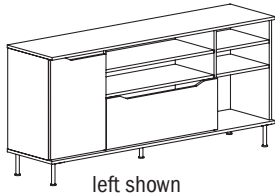

- one door with two fixed shelves, one storage drawer with two open compartments, one cabinet with two fixed shelves
- linking hardware
- interior dividers have a wire pass thru
- rectangular back center grommet available, specify and add \$79 list
- 24" wire manager included for field installation

Tall Storage Credenza	18	72	33	180	25	BS1872-33SFS	\$2,551
-----------------------	----	----	----	-----	----	--------------	---------

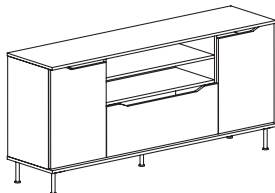

- one door with two fixed shelves, one storage drawer with two open compartments, one door with two fixed shelves
- linking hardware
- interior dividers have a wire pass thru
- rectangular back center grommet available, specify and add \$79 list
- 24" wire manager included for field installation

To Order, Specify:

- ① Model Number
- ② Wood Species - Rift Cut White Oak (WK4) or Flat Cut Walnut (WA1)
- ③ Wood Finish
- ④ Door and Drawer Front Optional Paint Color
- ⑤ Metal Leg Color - Matte Black (MBK), Soft Nickel (SNK) or Stardust Silver (STS)
- ⑥ Optional Back (Black) Grommet (see page 134)

③ Wood Finish Options:

- CLK Clear on Rift Cut White Oak
CLW Clear on Flat Cut Walnut

④ Paint Color Options:

- BKD Backdrop GRV Greek Villa
BFX Black Fox NET Network Gray
BWH Bright White NWH Nonchalant White
CGP Cargo Pants STM Storm
CHT Chatroom TRC Tricorn Black
FRR French Roast

Specifications:

- Wood species - Rift Cut White Oak or Flat Cut Walnut.
- 3/4" thick plywood tops
- Exterior feet and leg frames are fabricated from 14 gauge steel tubing and 14 gauge flat stock.

Modular

Description	D	W	H	CTN WT	CU FT	① Model	List Price No Cushion	List Price With Cushion
Low Height Transition Credenza	18	54	14 1/2 / 20	110	11	BS1854-20TOSR	\$2,026	COM \$2,360
Open Storage	18	54	14 1/2 / 20	110	11	BS1854-20TOSL	\$2,026	A \$2,368
								B \$2,382
								COL/C \$2,408
								D \$2,441
								E \$2,474
								F \$2,526
								G \$2,580
								H \$2,639
								I \$2,730
								J \$2,841
								L1 \$2,620
								L2 \$2,686
Low Height Transition Credenza	18	72	14 1/2 / 20	120	15	BS1872-20TOSR	\$2,233	COM \$2,726
Open Storage	18	72	14 1/2 / 20	120	15	BS1872-20TOSL	\$2,233	A \$2,739
								B \$2,763
								COL/C \$2,806
								D \$2,862
								E \$2,916
								F \$3,001
								G \$3,094
								H \$3,191
								I \$3,344
								J \$3,527
								L1 \$3,161
								L2 \$3,270
Low Height Transition Storage Credenza	18	72	14 1/2 / 20	110	15	BS1872-20TSR	\$2,486	COM \$2,979
	18	72	14 1/2 / 20	110	15	BS1872-20TSL	\$2,486	A \$2,992
								B \$3,016
								COL/C \$3,059
								D \$3,115
								E \$3,169
								F \$3,254
								G \$3,347
								H \$3,444
								I \$3,597
								J \$3,780
								L1 \$3,414
								L2 \$3,523

- open cabinet
- bent ply top
- linking hardware
- optional attached 1 1/2" thick cushion
- interior dividers have a wire pass thru
- two rectangular back center grommets available, specify and add \$158 list
- 24" wire manager included for field installation
- com ydg: 3/4

- open cabinet, one fixed shelf
- bent ply top
- linking hardware
- optional attached 1 1/2" thick cushion
- interior dividers have a wire pass thru
- two rectangular back center grommets available, specify and add \$158 list
- 24" wire manager included for field installation
- com ydg: 1 1/4

- two drawers, open cabinet
- bent ply top
- linking hardware
- optional attached 1 1/2" thick cushion
- interior dividers have a wire pass thru
- two rectangular back center grommets available, specify and add \$158 list
- 24" wire manager included for field installation
- com ydg: 1 1/4

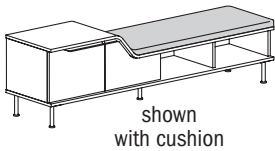
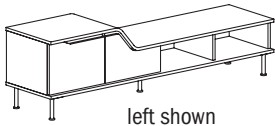
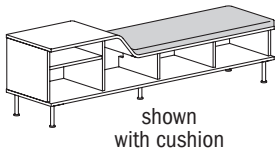
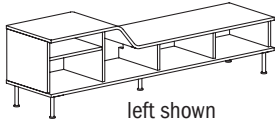
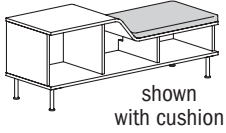
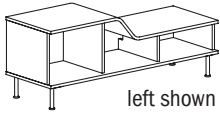

LOUNGE

Modular

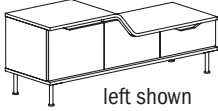
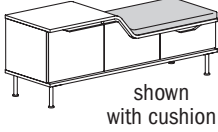
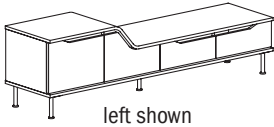
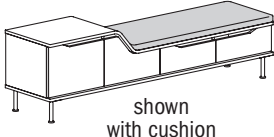
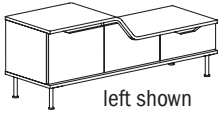
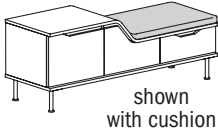
Description	D	W	H	CTN WT	CU FT	① Model	List Price No Cushion	List Price With Cushion
Low Height Transition Storage Credenza	18	54	14 1/2 / 20	120	11	BS1854-20TFSR	\$2,427	COM \$2,761
	18	54	14 1/2 / 20	120	11	BS1854-20TFSL	\$2,427	A \$2,769 B \$2,783 COL/C \$2,809 D \$2,842 E \$2,875 F \$2,927 G \$2,981 H \$3,040 I \$3,132 J \$3,242 L1 \$3,021 L2 \$3,087
 left shown	<ul style="list-style-type: none"> • three drawers • bent ply top • linking hardware • optional attached 1 1/2" thick cushion • interior dividers have a wire pass thru • two rectangular back center grommets available, specify and add \$158 list • 24" wire manager included for field installation • com ydg: 3/4 							
 shown with cushion								
Low Height Transition Storage Credenza	18	72	14 1/2 / 20	130	15	BS1872-20TFSR	\$2,649	COM \$3,142
	18	72	14 1/2 / 20	130	15	BS1872-20TFSL	\$2,649	A \$3,155 B \$3,179 COL/C \$3,222 D \$3,278 E \$3,332 F \$3,417 G \$3,510 H \$3,607 I \$3,759 J \$3,943 L1 \$3,577 L2 \$3,686
 left shown	<ul style="list-style-type: none"> • four drawers • bent ply top • linking hardware • optional attached 1 1/2" thick cushion • interior dividers have a wire pass thru • two rectangular back center grommets available, specify and add \$158 list • 24" wire manager included for field installation • com ydg: 1 1/4 							
 shown with cushion								
Low Height Transition Storage Credenza	18	54	14 1/2 / 20	130	11	BS1854-20TDSR	\$2,462	COM \$2,796
	18	54	14 1/2 / 20	130	11	BS1854-20TDSL	\$2,462	A \$2,804 B \$2,818 COL/C \$2,844 D \$2,876 E \$2,910 F \$2,961 G \$3,016 H \$3,075 I \$3,166 J \$3,276 L1 \$3,056 L2 \$3,122
 left shown	<ul style="list-style-type: none"> • one door with fixed shelf, two drawers • bent ply top • linking hardware • optional attached 1 1/2" thick cushion • interior dividers have a wire pass thru • two rectangular back center grommets available, specify and add \$158 list • 24" wire manager included for field installation • com ydg: 3/4 							
 shown with cushion								

To Order, Specify:

- ① Model Number
- ② Wood Species - Rift Cut White Oak (WK4) or Flat Cut Walnut (WA1)
- ③ Wood Finish
- ④ Door and Drawer Front Optional Paint Color
- ⑤ Metal Leg Color - Matte Black (MBK), Soft Nickel (SNK) or Stardust Silver (STS)
- ⑥ Fabric Selection - Vendor, Pattern and Color
- ⑦ Optional Back (Black) Grommet (see page 134)

③ Wood Finish Options:

- CLK Clear on Rift Cut White Oak
- CLW Clear on Flat Cut Walnut

④ Paint Color Options:

- BKD Backdrop
- BFX Black Fox
- BWH Bright White
- CGP Cargo Pants
- CHT Chatroom
- FRR French Roast
- GRV Greek Villa
- NET Network Gray
- NWH Nonchalant White
- STM Storm
- TRC Tricorn Black

⑥ Fabric Selection:

See a selection of graded in fabric manufacturers and patterns on pages 12-20. Contact Customer Service for additional fabric options.

Specifications:

- Wood species - Rift Cut White Oak or Flat Cut Walnut.
- 3/4" thick plywood tops
- Exterior feet and leg frames are fabricated from 14 gauge steel tubing and 14 gauge flat stock.

Modular

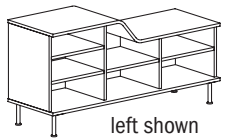
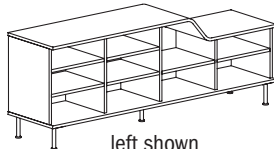
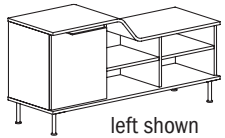
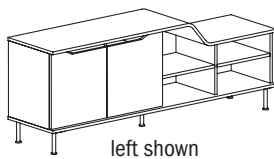
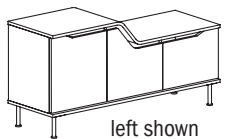
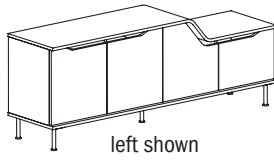
Description	D	W	H	CTN WT	CU FT	Model	List Price
Standard Height Transition Credenza Open Storage	18	54	20 / 27	120	15	BS1854-27TOSR	\$2,444
	18	54	20 / 27	120	15	BS1854-27TOSL	\$2,444
 <p>left shown</p> <ul style="list-style-type: none"> · open cabinet, four fixed shelves · bent ply top · linking hardware · interior dividers have a wire pass thru · two rectangular back center grommets available, specify and add \$158 list · 24" wire manager included for field installation 							
	Standard Height Transition Credenza Open Storage	18	72	20 / 27	130	20	BS1872-27TOSR
18		72	20 / 27	130	20	BS1872-27TOSL	\$2,586
 <p>left shown</p> <ul style="list-style-type: none"> · open cabinet, six fixed shelves · bent ply top · linking hardware · interior dividers have a wire pass thru · two rectangular back center grommets available, specify and add \$158 list · 24" wire manager included for field installation 							
	Standard Height Transition Credenza	18	54	20 / 27	130	15	BS1854-27THDR
18		54	20 / 27	130	15	BS1854-27THDL	\$2,524
 <p>left shown</p> <ul style="list-style-type: none"> · one door with two fixed shelves, open cabinet with two fixed shelves · bent ply top · linking hardware · interior dividers have a wire pass thru · two rectangular back center grommets available, specify and add \$158 list · 24" wire manager included for field installation 							
	Standard Height Transition Credenza Open Storage	18	72	20 / 27	140	20	BS1872-27TSR
18		72	20 / 27	140	20	BS1872-27TSL	\$2,747
 <p>left shown</p> <ul style="list-style-type: none"> · two doors with two fixed shelves, open cabinets with two fixed shelves · bent ply top · linking hardware · interior dividers have a wire pass thru · two rectangular back center grommets available, specify and add \$158 list · 24" wire manager included for field installation 							
	Standard Height Transition Credenza Full Storage	18	54	20 / 27	140	15	BS1854-27TFSR
18		54	20 / 27	140	15	BS1854-27TFSL	\$2,707
 <p>left shown</p> <ul style="list-style-type: none"> · one door with two fixed shelves, two drawers · bent ply top · linking hardware · interior dividers have a wire pass thru · two rectangular back center grommets available, specify and add \$158 list · 24" wire manager included for field installation 							
	Standard Height Transition Credenza Full Storage	18	72	20 / 27	160	20	BS1872-27TFSR
18		72	20 / 27	160	20	BS1872-27TFSL	\$3,063
 <p>left shown</p> <ul style="list-style-type: none"> · two doors with two fixed shelves, two drawers · bent ply top · linking hardware · interior dividers have a wire pass thru · two rectangular back center grommets available, specify and add \$158 list · 24" wire manager included for field installation 							

LOUNGE

Modular

Description	D	W	H	CTN WT	CU FT	① Model	List Price
Tall Transition Credenza	18	54	27 / 33	130	19	BS1854-33TOSR	\$2,530
Open Storage	18	54	27 / 33	130	19	BS1854-33TOSL	\$2,530

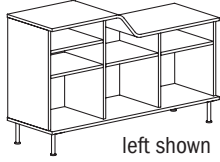

- open cabinet, four fixed shelves
- bent ply top
- linking hardware
- interior dividers have a wire pass thru
- two rectangular back center grommets available, specify and add \$158 list
- 24" wire manager included for field installation

Tall Transition Credenza	18	72	27 / 33	140	25	BS1872-33TOSR	\$2,759
Open Storage	18	72	27 / 33	140	25	BS1872-33TOSL	\$2,759

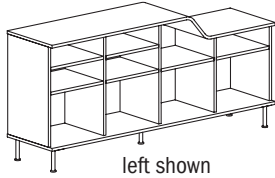

- open cabinet, six fixed shelves
- bent ply top
- linking hardware
- interior dividers have a wire pass thru
- two rectangular back center grommets available, specify and add \$158 list
- 24" wire manager included for field installation

Tall Transition Storage Credenza	18	72	27 / 33	150	25	BS1872-33TSR	\$2,952
	18	72	27 / 33	150	25	BS1872-33TSL	\$2,952

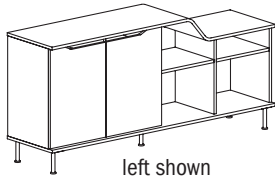

- two doors with two fixed shelves,
- open cabinet with two fixed shelves
- bent ply top
- linking hardware
- interior dividers have a wire pass thru
- two rectangular back center grommets available, specify and add \$158 list
- 24" wire manager included for field installation

Tall Transition Storage Credenza	18	54	27 / 33	150	19	BS1854-33TFSR	\$2,853
	18	54	27 / 33	150	19	BS1854-33TFSL	\$2,853

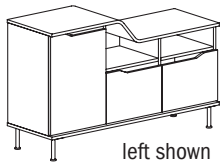

- one door with two fixed shelves,
- two drawers with open compartments
- bent ply top
- linking hardware
- interior dividers have a wire pass thru
- two rectangular back center grommets available, specify and add \$158 list
- 24" wire manager included for field installation

Tall Transition Storage Credenza	18	72	27 / 33	170	25	BS1872-33TFSR	\$3,253
	18	72	27 / 33	170	25	BS1872-33TFSL	\$3,253

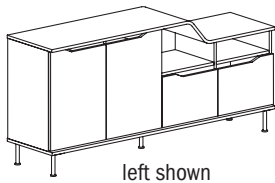

- two doors with two fixed shelves,
- two drawers with open compartments
- bent ply top
- linking hardware
- interior dividers have a wire pass thru
- two rectangular back center grommets available, specify and add \$158 list
- 24" wire manager included for field installation

To Order, Specify:

- ① Model Number
- ② Wood Species - Rift Cut White Oak (WK4) or Flat Cut Walnut (WA1)
- ③ Wood Finish
- ④ Door/Drawer Front Optional Paint Color
- ⑤ Metal Leg Color - Matte Black (MBK), Soft Nickel (SNK) or Stardust Silver (STS)
- ⑥ Optional Back (Black) Grommet (see page 134)

③ Wood Finish Options:

- CLK Clear on Rift Cut White Oak
CLW Clear on Flat Cut Walnut

④ Paint Color Options:

- BKD Backdrop GRV Greek Villa
BFX Black Fox NET Network Gray
BWH Bright White NWH Nonchalant White
CGP Cargo Pants STM Storm
CHT Chatroom TRC Tricorn Black
FRR French Roast

Specifications:

- Wood species - Rift Cut White Oak or Flat Cut Walnut.
- 3/4" thick plywood tops
- Exterior feet and leg frames are fabricated from 14 guage steel tubing and 14 guage flat stock.

Description	D	W	H	CTN WT	CU FT	Model	List Price
Open Bookcase	18	36	48	99	22	BS1836-480BC	\$1,701

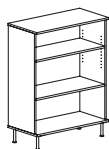

straight shelf

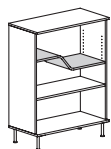

optional bent plywood

- open cabinet, two shelves
- lower shelf fixed, always straight
- upper shelf adjustable, straight standard; bent plywood available, specify and add \$604 to list - see page 137 for more information on shelving
- specify back height: full back, mid back or low back - see page 137 for more information on back heights
- specify metal leg color option: Matte Black (MBK), Soft Nickel (SNK) or Stardust Silver (STS)
- linking hardware

Open Bookcase with Lower Doors	18	36	48	115	22	BS1836-48SBC	\$1,827
---------------------------------------	----	----	----	-----	----	---------------------	----------------



straight shelf

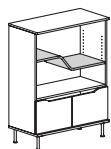

optional bent plywood

- two doors, open cabinet with two shelves
- lower shelf fixed, always straight
- upper shelf adjustable, straight standard; bent plywood available, specify and add \$604 to list - see page 137 for more information on shelving
- specify back height: full back, mid back or low back - see page 137 for more information on back heights
- specify metal leg color option: Matte Black (MBK), Soft Nickel (SNK) or Stardust Silver (STS)
- linking hardware

Open Storage Bookcase with Tower	18	54	48	165	33	BS1854-480BCR	\$2,069
	18	54	48	165	33	BS1854-480BCL	\$2,069

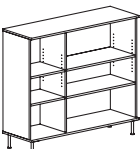

straight shelf

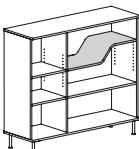

optional bent plywood

lefts shown

- open cabinet, four shelves
- two lower shelves fixed, always straight
- two upper shelves adjustable, straight standard; bent plywood available on wide shelf, specify and add \$604 to list - see page 137 for more information on shelving
- specify back height: full back, mid back or low back - see page 137 for more information on back heights
- specify metal leg color option: Matte Black (MBK), Soft Nickel (SNK) or Stardust Silver (STS)
- linking hardware

Storage Bookcase with Lower Doors and Tower	18	54	48	181	33	BS1854-48DBCR	\$2,205
	18	54	48	181	33	BS1854-48DBCL	\$2,205



straight shelf

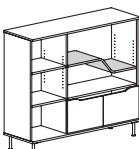

optional bent plywood

lefts shown

- two doors, open cabinet
- two lower shelves fixed, always straight
- two upper shelves adjustable, straight standard; bent plywood available on wide shelf, specify and add \$604 to list - see page 137 for more information on shelving
- specify back height: full back, mid back or low back - see page 137 for more information on back heights
- specify metal leg color option: Matte Black (MBK), Soft Nickel (SNK) or Stardust Silver (STS)
- linking hardware

Description	D	W	H	CTN WT	CU FT	① Model	List Price
Storage Bookcase with Tower Door	18	54	48	185	33	BS1854-48TBCR	\$2,205
	18	54	48	185	33	BS1854-48TBCL	\$2,205



straight shelf

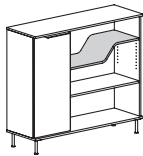

optional bent plywood

lefts shown

- tower door with two shelves, lower shelf fixed
- open cabinet with two shelves
- lower shelf fixed, always straight
- upper shelf adjustable, straight standard; bent plywood available on upper shelf, specify and add \$604 to list - see page 137 for more information on shelving
- specify back height: full back, mid back or low back - see page 137 for more information on back heights
- specify metal leg color option: Matte Black (MBK), Soft Nickel (SNK) or Stardust Silver (STS)
- linking hardware

Storage Bookcase with Full Door Set and Tower	18	54	48	201	33	BS1854-48SBCR	\$2,310
	18	54	48	201	33	BS1854-48SBCL	\$2,310



straight shelf

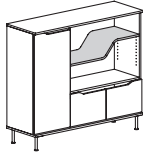

optional bent plywood

lefts shown

- tower door with two shelves, lower shelf fixed
- open cabinet with two shelves
- lower shelf fixed, always straight
- upper shelf adjustable, straight standard; bent plywood available on adjustable shelf, specify and add \$604 to list - see page 137 for more information on shelving
- specify back height: full back, mid back or low back - see page 137 for more information on back heights
- specify metal leg color option: Matte Black (MBK), Soft Nickel (SNK) or Stardust Silver (STS)
- linking hardware

To Order, Specify:

- ① Model Number
- ② Wood Species - Rift Cut White Oak (WK4) or Flat Cut Walnut (WA1)
- ③ Wood Finish
- ④ Door Front Optional Paint Color
- ⑤ Back Height - Full Back, Mid Back, Low Back
- ⑥ Metal Leg Color - Matte Black (MBK), Soft Nickel (SNK) or Stardust Silver (STS)

③ Wood Finish Options:

- CLK Clear on Rift Cut White Oak
CLW Clear on Flat Cut Walnut

④ Paint Color Options:

- | | |
|------------------|----------------------|
| BKD Backdrop | GRV Greek Villa |
| BFX Black Fox | NET Network Gray |
| BWH Bright White | NWH Nonchalant White |
| CGP Cargo Pants | STM Storm |
| CHT Chatroom | TRC Tricorn Black |
| FRR French Roast | |

Specifications:

- Wood species - Rift Cut White Oak or Flat Cut Walnut.
- 3/4" thick plywood tops
- Exterior feet and leg frames are fabricated from 14 gauge steel tubing and 14 gauge flat stock.

Description	D	W	H	CTN WT	CU FT	Model	List Price
Open Bookcase	18	36	68	114	31	BS1836-680BC	\$1,995

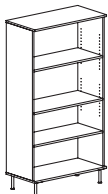

straight shelves

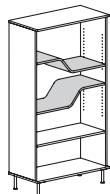

optional bent plywood

- open cabinet, three shelves
- lower shelf fixed, always straight
- two upper shelves adjustable, straight standard; bent plywood available, specify and add \$604 per shelf to list - see page 137 for more information on shelving
- specify back height: full back, mid back or low back - see page 137 for more information on back heights
- specify metal leg color option: Matte Black (MBK), Soft Nickel (SNK) or Stardust Silver (STS)
- linking hardware

Open Bookcase with Lower Doors	18	36	68	130	31	BS1836-68SBC	\$2,121
---------------------------------------	----	----	----	-----	----	---------------------	----------------

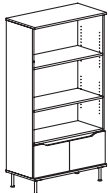

straight shelves

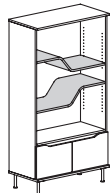

optional bent plywood

- two doors, open cabinet with three shelves
- lower shelf fixed, always straight
- two upper shelves adjustable, straight standard; bent plywood available, specify and add \$604 per shelf to list - see page 137 for more information on shelving
- specify back height: full back, mid back or low back - see page 137 for more information on back heights
- specify metal leg color option: Matte Black (MBK), Soft Nickel (SNK) or Stardust Silver (STS)
- linking hardware

Open Storage Bookcase with Tower	18	54	68	209	46	BS1854-680BCR	\$2,373
	18	54	68	209	46	BS1854-680BCL	\$2,373

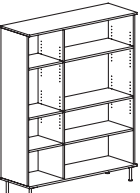

straight shelves

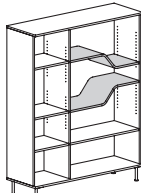

optional bent plywood

lefts shown

- open cabinet, six shelves
- two lower shelves fixed, always straight
- four upper shelves adjustable, straight standard; bent plywood available on wide shelves, specify and add \$604 per shelf to list - see page 137 for more information on shelving
- specify back height: full back, mid back or low back - see page 137 for more information on back heights
- specify metal leg color option: Matte Black (MBK), Soft Nickel (SNK) or Stardust Silver (STS)
- linking hardware

Storage Bookcase with Lower Doors and Tower	18	54	68	225	46	BS1854-68DBCR	\$2,494
	18	54	68	225	46	BS1854-68DBCL	\$2,494

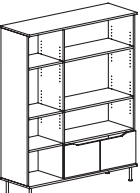

straight shelves

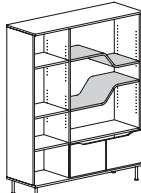

optional bent plywood

lefts shown

- two doors, open cabinet with six shelves
- two lower shelves fixed, always straight
- four upper shelves adjustable, straight standard; bent plywood available on wide shelves, specify and add \$604 per shelf to list - see page 137 for more information on shelving
- specify back height: full back, mid back or low back - see page 137 for more information on back heights
- specify metal leg color option: Matte Black (MBK), Soft Nickel (SNK) or Stardust Silver (STS)
- linking hardware

Description	D	W	H	CTN WT	CU FT	① Model	List Price
Storage Bookcase with Tower Door	18	54	68	234	46	BS1854-68TBCR	\$2,494
	18	54	68	234	46	BS1854-68TBCL	\$2,494

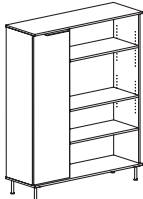

straight shelves

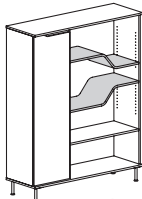

optional bent plywood

lefts shown

- tower door with three shelves, lower shelf fixed
- open cabinet with three shelves
- lower shelf fixed, always straight
- two upper shelves adjustable, straight standard; bent plywood available on adjustable shelves, specify and add \$604 per shelf to list - see page 137 for more information on shelving
- specify back height: full back, mid back or low back - see page 137 for more information on back heights
- specify metal leg color option: Matte Black (MBK), Soft Nickel (SNK) or Stardust Silver (STS)
- linking hardware

Storage Bookcase with Full Door Set and Tower	18	54	68	250	46	BS1854-68SBCR	\$2,599
	18	54	68	250	46	BS1854-68SBCL	\$2,599

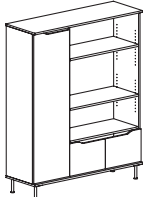

straight shelves

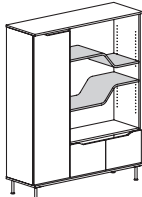

optional bent plywood

lefts shown

- tower door with three shelves, lower shelf fixed
- open cabinet with three shelves
- lower shelf fixed, always straight;
- two upper shelves adjustable, straight standard; bent plywood available on adjustable shelves, specify and add \$604 per shelf to list - see page 137 for more information on shelving
- specify back height: full back, mid back or low back - see page 137 for more information on back heights
- specify metal leg color option: Matte Black (MBK), Soft Nickel (SNK) or Stardust Silver (STS)
- linking hardware

To Order, Specify:

- ① Model Number
- ② Wood Species - Rift Cut White Oak (WK4) or Flat Cut Walnut (WA1)
- ③ Wood Finish
- ④ Door Front Optional Paint Color
- ⑤ Back Height - Full Back, Mid Back, Low Back
- ⑥ Metal Leg Color - Matte Black (MBK), Soft Nickel (SNK) or Stardust Silver (STS)

③ Wood Finish Options:

- CLK Clear on Rift Cut White Oak
- CLW Clear on Flat Cut Walnut

④ Paint Color Options:

- BKD Backdrop
- BFX Black Fox
- BWH Bright White
- CGP Cargo Pants
- CHT Chatroom
- FRR French Roast
- GRV Greek Villa
- NET Network Gray
- NWH Nonchalant White
- STM Storm
- TRC Tricorn Black

Specifications:

- Wood species - Rift Cut White Oak or Flat Cut Walnut.
- 3/4" thick plywood tops
- Exterior feet and leg frames are fabricated from 14 gauge steel tubing and 14 gauge flat stock.

Description	D	W	H	CTN WT	CU FT	❶ Model	List Price
Power Center Under Mount	6	3 5/8	2 1/2	4	1	EC21	\$450

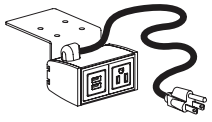

- mounts under platform or surface
- field installable
- one power receptacle - 110 volt, one dual USB port
- 10' power cord with molded plug
- specify Black (B) or White (W) finish

To Order, Specify:

- ❶ Model Number

Collective Lounge Order Check List:



Specify:

- 1. Model Number
- 2. Wood Species - Maple (M)
- 3. Wood Finish
- 4. Fabric Selection - vendor, pattern and color

Example:

CL4566 | M | AUB | MOMENTUM | VOX | MYSTIC
 (model #) | (wood species) | (finish) | (fabric vendor) | (pattern name) | (pattern color)

1. Model Number

2. Wood Species - Maple (M)

3. Wood Finish Options:

ALE Ale	FLX Flax
AUB Auburn	LGC Legacy
AUT Autumn	MCH Mocha
BRL Barley	NTO Night Owl
BBN Bourbon	PRL Praline
BRG Brighton	SAF Saffron
BUT Butterscotch	SIE Sienna
CIN Cinnamon	TOF Toffee
CLA Classic	TRF Truffle
EAR Earthy	VEN Venetian
ESP Espresso	

4. Fabric Selection - Please supply the following:

- Fabric vendor
- Pattern name
- Pattern color

When specifying contrasting upholstery, indicate clearly which upholstery is to be applied to the seat, back and arms. Use higher grade pricing.

- Indicate direction of fabric - Railroaded or Up the Roll
- Please provide illustration, if available

All COM orders must include the following:

- Vendor's name, pattern name and color
- Sample of the fabric attached to order
- Model numbers of items for fabric application
- Special application instructions (e.g., all stripes will be applied front to back unless specified otherwise)
- Customer and purchase order number

Ship prepaid COM material to:
 JSI
 Attn: COM Dept
 932 Mill Street
 Jasper, IN 47546

Application of fabric:
 Railroaded Up the Roll

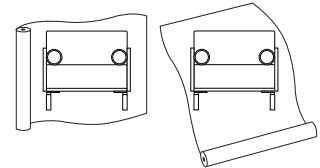

All COM orders will ship at standard lead time from receipt of COM except for orders requiring special custom matched finishes.

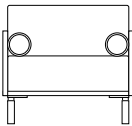
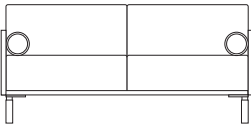
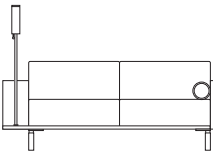
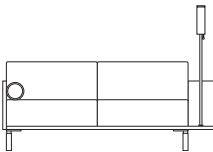
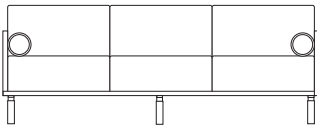
Description	① Model	Specifications	List Price Per Grade																												
Single Seat 	CL4566 · wood surround · upholstered seat and back · bolsters attach with snap hooks · bolster COM ydg - 1 ½ · bolster COL sq ft - 27	<table border="1"> <thead> <tr> <th>Dimensions</th> <th>D</th> <th>W</th> <th>H</th> </tr> </thead> <tbody> <tr> <td>Overall</td> <td>30</td> <td>33 ¾</td> <td>30 ¾</td> </tr> <tr> <td>Seat</td> <td>20</td> <td>19 ½</td> <td>17 ½</td> </tr> <tr> <td>Arm</td> <td></td> <td></td> <td>24</td> </tr> </tbody> </table>	Dimensions	D	W	H	Overall	30	33 ¾	30 ¾	Seat	20	19 ½	17 ½	Arm			24	<table border="1"> <thead> <tr> <th colspan="2">Upholstery</th> <th colspan="2">Shipping</th> </tr> </thead> <tbody> <tr> <td>COM Ydg</td> <td>3 ½</td> <td>Ctn Wt</td> <td>143</td> </tr> <tr> <td>COL Sq Ft</td> <td>70</td> <td>Cu Ft</td> <td>21</td> </tr> </tbody> </table>	Upholstery		Shipping		COM Ydg	3 ½	Ctn Wt	143	COL Sq Ft	70	Cu Ft	21
		Dimensions	D	W	H																										
Overall	30	33 ¾	30 ¾																												
Seat	20	19 ½	17 ½																												
Arm			24																												
Upholstery		Shipping																													
COM Ydg	3 ½	Ctn Wt	143																												
COL Sq Ft	70	Cu Ft	21																												
			<table border="1"> <tbody> <tr><td>COM</td><td>\$2,777</td></tr> <tr><td>A</td><td>\$2,808</td></tr> <tr><td>B</td><td>\$2,869</td></tr> <tr><td>COL/C</td><td>\$2,975</td></tr> <tr><td>D</td><td>\$3,112</td></tr> <tr><td>E</td><td>\$3,248</td></tr> <tr><td>F</td><td>\$3,393</td></tr> <tr><td>G</td><td>\$3,598</td></tr> <tr><td>H</td><td>\$3,817</td></tr> <tr><td>I</td><td>\$4,160</td></tr> <tr><td>J</td><td>\$4,570</td></tr> <tr><td>L1</td><td>\$3,749</td></tr> <tr><td>L2</td><td>\$3,995</td></tr> </tbody> </table>	COM	\$2,777	A	\$2,808	B	\$2,869	COL/C	\$2,975	D	\$3,112	E	\$3,248	F	\$3,393	G	\$3,598	H	\$3,817	I	\$4,160	J	\$4,570	L1	\$3,749	L2	\$3,995		
COM	\$2,777																														
A	\$2,808																														
B	\$2,869																														
COL/C	\$2,975																														
D	\$3,112																														
E	\$3,248																														
F	\$3,393																														
G	\$3,598																														
H	\$3,817																														
I	\$4,160																														
J	\$4,570																														
L1	\$3,749																														
L2	\$3,995																														
Two Seat 	CL4576 · wood surround · upholstered seat and back · bolsters attach with snap hooks · bolster COM ydg - 1 ½ · bolster COL sq ft - 27	<table border="1"> <thead> <tr> <th>Dimensions</th> <th>D</th> <th>W</th> <th>H</th> </tr> </thead> <tbody> <tr> <td>Overall</td> <td>30</td> <td>65 ¾</td> <td>30 ¾</td> </tr> <tr> <td>Seat</td> <td>20</td> <td>51</td> <td>17 ½</td> </tr> <tr> <td>Arm</td> <td></td> <td></td> <td>24</td> </tr> </tbody> </table>	Dimensions	D	W	H	Overall	30	65 ¾	30 ¾	Seat	20	51	17 ½	Arm			24	<table border="1"> <thead> <tr> <th colspan="2">Upholstery</th> <th colspan="2">Shipping</th> </tr> </thead> <tbody> <tr> <td>COM Ydg</td> <td>7</td> <td>Ctn Wt</td> <td>242</td> </tr> <tr> <td>COL Sq Ft</td> <td>140</td> <td>Cu Ft</td> <td>40</td> </tr> </tbody> </table>	Upholstery		Shipping		COM Ydg	7	Ctn Wt	242	COL Sq Ft	140	Cu Ft	40
		Dimensions	D	W	H																										
Overall	30	65 ¾	30 ¾																												
Seat	20	51	17 ½																												
Arm			24																												
Upholstery		Shipping																													
COM Ydg	7	Ctn Wt	242																												
COL Sq Ft	140	Cu Ft	40																												
			<table border="1"> <tbody> <tr><td>COM</td><td>\$3,561</td></tr> <tr><td>A</td><td>\$3,623</td></tr> <tr><td>B</td><td>\$3,745</td></tr> <tr><td>COL/C</td><td>\$3,957</td></tr> <tr><td>D</td><td>\$4,231</td></tr> <tr><td>E</td><td>\$4,504</td></tr> <tr><td>F</td><td>\$4,794</td></tr> <tr><td>G</td><td>\$5,203</td></tr> <tr><td>H</td><td>\$5,641</td></tr> <tr><td>I</td><td>\$6,326</td></tr> <tr><td>J</td><td>\$7,147</td></tr> <tr><td>L1</td><td>\$5,505</td></tr> <tr><td>L2</td><td>\$5,997</td></tr> </tbody> </table>	COM	\$3,561	A	\$3,623	B	\$3,745	COL/C	\$3,957	D	\$4,231	E	\$4,504	F	\$4,794	G	\$5,203	H	\$5,641	I	\$6,326	J	\$7,147	L1	\$5,505	L2	\$5,997		
COM	\$3,561																														
A	\$3,623																														
B	\$3,745																														
COL/C	\$3,957																														
D	\$4,231																														
E	\$4,504																														
F	\$4,794																														
G	\$5,203																														
H	\$5,641																														
I	\$6,326																														
J	\$7,147																														
L1	\$5,505																														
L2	\$5,997																														
Two Seat  <p>CL4576R right</p>  <p>CL4576L left</p>	CL4576R CL4576L · wood surround · upholstered seat and back · bolsters attaches with snap hooks · extruded aluminum lamp with frosted glass shade and 8 ½' long cord · bolster COM ydg - 1 · bolster COL sq ft - 18	<table border="1"> <thead> <tr> <th>Dimensions</th> <th>D</th> <th>W</th> <th>H</th> </tr> </thead> <tbody> <tr> <td>Overall</td> <td>30</td> <td>73 ¼</td> <td>30 ¾</td> </tr> <tr> <td>Seat</td> <td>20</td> <td>57</td> <td>17 ½</td> </tr> <tr> <td>Arm</td> <td></td> <td></td> <td>24</td> </tr> </tbody> </table>	Dimensions	D	W	H	Overall	30	73 ¼	30 ¾	Seat	20	57	17 ½	Arm			24	<table border="1"> <thead> <tr> <th colspan="2">Upholstery</th> <th colspan="2">Shipping</th> </tr> </thead> <tbody> <tr> <td>COM Ydg</td> <td>7</td> <td>Ctn Wt</td> <td>242</td> </tr> <tr> <td>COL Sq Ft</td> <td>140</td> <td>Cu Ft</td> <td>45</td> </tr> </tbody> </table>	Upholstery		Shipping		COM Ydg	7	Ctn Wt	242	COL Sq Ft	140	Cu Ft	45
		Dimensions	D	W	H																										
Overall	30	73 ¼	30 ¾																												
Seat	20	57	17 ½																												
Arm			24																												
Upholstery		Shipping																													
COM Ydg	7	Ctn Wt	242																												
COL Sq Ft	140	Cu Ft	45																												
			<table border="1"> <tbody> <tr><td>COM</td><td>\$3,969</td></tr> <tr><td>A</td><td>\$4,031</td></tr> <tr><td>B</td><td>\$4,153</td></tr> <tr><td>COL/C</td><td>\$4,365</td></tr> <tr><td>D</td><td>\$4,639</td></tr> <tr><td>E</td><td>\$4,912</td></tr> <tr><td>F</td><td>\$5,202</td></tr> <tr><td>G</td><td>\$5,612</td></tr> <tr><td>H</td><td>\$6,050</td></tr> <tr><td>I</td><td>\$6,734</td></tr> <tr><td>J</td><td>\$7,555</td></tr> <tr><td>L1</td><td>\$5,913</td></tr> <tr><td>L2</td><td>\$6,405</td></tr> </tbody> </table>	COM	\$3,969	A	\$4,031	B	\$4,153	COL/C	\$4,365	D	\$4,639	E	\$4,912	F	\$5,202	G	\$5,612	H	\$6,050	I	\$6,734	J	\$7,555	L1	\$5,913	L2	\$6,405		
COM	\$3,969																														
A	\$4,031																														
B	\$4,153																														
COL/C	\$4,365																														
D	\$4,639																														
E	\$4,912																														
F	\$5,202																														
G	\$5,612																														
H	\$6,050																														
I	\$6,734																														
J	\$7,555																														
L1	\$5,913																														
L2	\$6,405																														
Three Seat 	CL4586 · wood surround · upholstered seat and back · bolsters attach with snap hooks · bolster COM ydg - 1 ½ · bolster COL sq ft - 27	<table border="1"> <thead> <tr> <th>Dimensions</th> <th>D</th> <th>W</th> <th>H</th> </tr> </thead> <tbody> <tr> <td>Overall</td> <td>30</td> <td>72 ¾</td> <td>30 ¾</td> </tr> <tr> <td>Seat</td> <td>20</td> <td>60</td> <td>17 ½</td> </tr> <tr> <td>Arm</td> <td></td> <td></td> <td>24</td> </tr> </tbody> </table>	Dimensions	D	W	H	Overall	30	72 ¾	30 ¾	Seat	20	60	17 ½	Arm			24	<table border="1"> <thead> <tr> <th colspan="2">Upholstery</th> <th colspan="2">Shipping</th> </tr> </thead> <tbody> <tr> <td>COM Ydg</td> <td>9</td> <td>Ctn Wt</td> <td>322</td> </tr> <tr> <td>COL Sq Ft</td> <td>180</td> <td>Cu Ft</td> <td>44</td> </tr> </tbody> </table>	Upholstery		Shipping		COM Ydg	9	Ctn Wt	322	COL Sq Ft	180	Cu Ft	44
		Dimensions	D	W	H																										
Overall	30	72 ¾	30 ¾																												
Seat	20	60	17 ½																												
Arm			24																												
Upholstery		Shipping																													
COM Ydg	9	Ctn Wt	322																												
COL Sq Ft	180	Cu Ft	44																												
			<table border="1"> <tbody> <tr><td>COM</td><td>\$4,316</td></tr> <tr><td>A</td><td>\$4,395</td></tr> <tr><td>B</td><td>\$4,551</td></tr> <tr><td>COL/C</td><td>\$4,825</td></tr> <tr><td>D</td><td>\$5,177</td></tr> <tr><td>E</td><td>\$5,529</td></tr> <tr><td>F</td><td>\$5,900</td></tr> <tr><td>G</td><td>\$6,428</td></tr> <tr><td>H</td><td>\$6,990</td></tr> <tr><td>I</td><td>\$7,870</td></tr> <tr><td>J</td><td>\$8,925</td></tr> <tr><td>L1</td><td>\$6,815</td></tr> <tr><td>L2</td><td>\$7,448</td></tr> </tbody> </table>	COM	\$4,316	A	\$4,395	B	\$4,551	COL/C	\$4,825	D	\$5,177	E	\$5,529	F	\$5,900	G	\$6,428	H	\$6,990	I	\$7,870	J	\$8,925	L1	\$6,815	L2	\$7,448		
COM	\$4,316																														
A	\$4,395																														
B	\$4,551																														
COL/C	\$4,825																														
D	\$5,177																														
E	\$5,529																														
F	\$5,900																														
G	\$6,428																														
H	\$6,990																														
I	\$7,870																														
J	\$8,925																														
L1	\$6,815																														
L2	\$7,448																														

LOUNGE

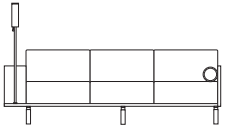
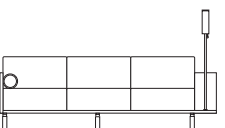
Description	① Model	Specifications			List Price Per Grade			
		Dimensions	D	W	H	COM		
Three Seat  CL4586R right  CL4586L left	CL4586R CL4586L <ul style="list-style-type: none"> · wood surround · upholstered seat and back · bolster attaches with snap hooks · extruded aluminum lamp with frosted glass shade and 8½' long cord · bolster COM ydg - 1 · bolster COL sq ft - 18 	Overall	30	82 ¼	30 ¾	COM	\$4,724	
		Seat	20	66	17 ½	COL/C	\$5,234	
		Arm				D	\$5,585	
		Upholstery		Shipping		E	\$5,937	
		COM Ydg	9	Ctn Wt	322	F	\$6,309	
		COL Sq Ft	180	Cu Ft	50	G	\$6,836	
							H	\$7,399
							I	\$8,279
							J	\$9,334
							L1	\$7,223
							L2	\$7,857

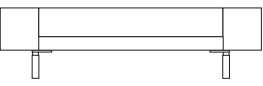
Description	① Model	Specifications			List Price Per Grade			
		Dimensions	D	W	H	COM		
48" W Bench 	CL4568 <ul style="list-style-type: none"> · wood surround · upholstered seat 	Overall	20	68	18	COM	\$3,148	
		Seat	20	48	18	A	\$3,166	
		Upholstery		Shipping		B	\$3,200	
		COM Ydg	1 ¾	Ctn Wt	118	COL/C	\$3,260	
		COL Sq Ft	35	Cu Ft	18	D	\$3,337	
							E	\$3,414
							F	\$3,534
							G	\$3,662
							H	\$3,798
							I	\$4,013
							J	\$4,269
							L1	\$3,756
							L2	\$3,927

To Order, Specify:

- ① Model Number
- ② Wood Species - Maple (M)
- ③ Wood Finish
- ④ Fabric Selection - vendor, pattern and color

⑤ Wood Finish Options:

ALE Ale	FLX Flax
AUB Auburn	LGC Legacy
AUT Autumn	MCH Mocha
BRL Barley	NTO Night Owl
BBN Bourbon	PRL Praline
BRG Brighton	SAF Saffron
BUT Butterscotch	SIE Sienna
CIN Cinnamon	TOF Toffee
CLA Classic	TRF Truffle
EAR Earthy	VEN Venetian
ESP Espresso	

④ See a selection of graded in fabric manufacturers and patterns on pages 12-20. Contact Customer Service for additional fabric options.

Specifications

- Wood species - Maple.
- Frame interior is hardwood glued with double dowels and reinforced with wood screws.
- Steel structured base has an Arctic Silver powder coat finish.
- Seat has synthetic sheet webbing with high resiliency seat polyurethane multi-density foam.
- Back has polypropylene webbing and multi-density polyurethane foam.

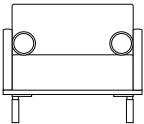
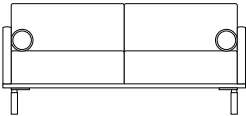
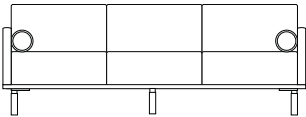
Description	① Model	Specifications				List Price Per Grade	
Single Seat 	CL4561 · upholstered surround, seat and back · bolsters attach with snap hooks · bolster COM ydg - 1 ½ · bolster COL sq ft - 27	Dimensions		D	W	H	COM \$2,667 A \$2,725 B \$2,838 COL/C \$3,035 D \$3,289 E \$3,543 F \$3,812 G \$4,193 H \$4,599 I \$5,235 J \$5,997 L1 \$4,472 L2 \$4,929
		Overall	31	36	30 ¾		
		Seat	20	19	17 ½		
		Arm			24		
		Upholstery		Shipping			
		COM Ydg	6 ½	Ctn Wt	97		
		COL Sq Ft	130	Cu Ft	29		
Two Seat 	CL4571 · upholstered surround, seat and back · bolsters attach with snap hooks · bolster COM ydg - 1 ½ · bolster COL sq ft - 27	Dimensions		D	W	H	COM \$3,468 A \$3,560 B \$3,743 COL/C \$4,062 D \$4,472 E \$4,882 F \$5,316 G \$5,931 H \$6,588 I \$7,614 J \$8,846 L1 \$6,382 L2 \$7,122
		Overall	31	67 ½	30 ¾		
		Seat	20	51	17 ½		
		Arm			24		
		Upholstery		Shipping			
		COM Ydg	10 ½	Ctn Wt	118		
		COL Sq Ft	210	Cu Ft	42		
Three Seat 	CL4581 · upholstered surround, seat and back · bolsters attach with snap hooks · bolster COM ydg - 1 ½ · bolster COL sq ft - 27	Dimensions		D	W	H	COM \$4,211 A \$4,330 B \$4,564 COL/C \$4,974 D \$5,502 E \$6,030 F \$6,587 G \$7,379 H \$8,223 I \$9,542 J \$11,125 L1 \$7,959 L2 \$8,909
		Overall	31	76 ½	30 ¾		
		Seat	20	60	17 ½		
		Arm			24		
		Upholstery		Shipping			
		COM Ydg	13 ½	Ctn Wt	139		
		COL Sq Ft	270	Cu Ft	48		

LOUNGE

Description	D	W	H	CTN WT	CU FT	① Model	List Price
Console Table	15	60	29	117	19	OCST4560-29	\$6,525

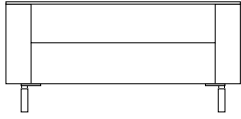

Coffee Table	24	48	17	181	15	OCFT4548-17	\$4,778
--------------	----	----	----	-----	----	-------------	---------

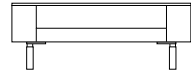

End Table	30	24	24	156	13	OET4524-24	\$3,984
-----------	----	----	----	-----	----	------------	---------

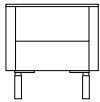

Coffee Table	36	36	17	162	16	OCFT4536-17	\$5,005
	30	30	17	151	12	OCFT4530-17	\$4,898

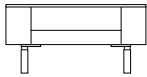

End Table	24	24	24	128	11	OST4524-24	\$4,173
	18	18	24	86	7	OST4518-24	\$3,660

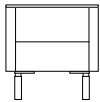

To Order, Specify:

- ① Model Number
- ② Wood Species - Maple (M)
- ③ Wood Finish
- ④ Fabric Selection - vendor, pattern and color

③ Wood Finish Options:

ALE	Ale	FLX	Flax
AUB	Auburn	LGC	Legacy
AUT	Autumn	MCH	Mocha
BRL	Barley	NTO	Night Owl
BBN	Bourbon	PRL	Praline
BRG	Brighton	SAF	Saffron
BUT	Butterscotch	SIE	Sienna
CIN	Cinnamon	TOF	Toffee
CLA	Classic	TRF	Truffle
EAR	Earthy	VEN	Venetian
ESP	Espresso		

- ④ See a selection of graded in fabric manufacturers and patterns on pages 12-20. Contact Customer Service for additional fabric options.

Seating Specifications

- Wood species - Maple.
- Frame interior is hardwood glued with double dowels and reinforced with wood screws.
- Steel structured base has an Arctic Silver powder coat finish.
- Seat has synthetic sheet webbing with high resiliency seat polyurethane multi-density foam.
- Back has polypropylene webbing and multi-density polyurethane foam.

Table Specifications

- Exposed wood surfaces are Maple veneer.
- ½" thick tempered frosted glass with screen print on underside and fingerprint resistant coating.
- Steel structured base has an Arctic Silver powder coat finish.
- Hardwood frame glued with double dowels and reinforced with wood screws.

Collective Motion Seating Order Check List:



Specify:

- 1. Model Number
- 2. Wood Species - Maple (M)
- 3. Wood Finish
- 4. Fabric Selection - vendor, pattern and color

Example:

CM4552 | **M** | **AUB** | **MOMENTUM** | **VOX** | **MYSTIC**
 (model #) | (wood species) | (finish) | (fabric vendor) | (pattern name) | (pattern color)

1. Model Number

2. Wood Species - Maple (M)

3. Wood Finish Options:

ALE Ale	FLX Flax
AUB Auburn	LGC Legacy
AUT Autumn	MCH Mocha
BRL Barley	NTO Night Owl
BBN Bourbon	PRL Praline
BRG Brighton	SAF Saffron
BUT Butterscotch	SIE Sienna
CIN Cinnamon	TOF Toffee
CLA Classic	TRF Truffle
EAR Earthy	VEN Venetian
ESP Espresso	

4. Fabric Selection - Please supply the following:

- Fabric vendor
- Pattern name
- Pattern color

When specifying contrasting upholstery, indicate clearly which upholstery is to be applied to the seat, back, surround, seat/back and bolster. Use higher grade pricing.

- Indicate direction of fabric - Railroaded or Up the Roll
- Please provide illustration, if available

All COM orders must include the following:

- Vendor's name, pattern name and color
- Sample of the fabric attached to order
- Model numbers of items for fabric application

- Special application instructions (e.g., all stripes will be applied front to back unless specified otherwise)
- Customer and purchase order number

Ship prepaid COM material to:
 JSI
 Attn: COM Dept
 932 Mill Street
 Jasper, IN 47546

Application of fabric:
 Railroaded Up the Roll

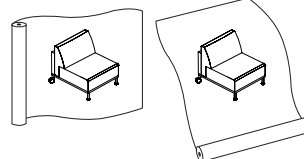

All COM orders will ship at standard lead time from receipt of COM except for orders requiring special custom matched finishes.

Collective Motion Tables Order Check List:



Specify:





- 1. Model Number
- 2. Top Style
- 3. Wood Species - Cherry (CH1), Makore (MK2), Maple (MA1) or Walnut (WA1)
- 4. Wood Finish
- 5. Fabric Selection - vendor, pattern and color

Example:

ORTL4536-18 | A1 | MA1 | ALE
 (model #) | (top style) | (wood species) | (finish)

1. Model Number

2. Top Style

-  Wood with Straight Edge (A1)
-  Wood with Reversed Bevel Edge (A9)
-  White Laminate Top with Bright White Reversed Bevel Edge (A10)
-  Back Painted Glass Top with "Write-On-It" Glossy Glass Top feature with Bright White Reversed Bevel Edge (G2)
-  Frosted Back Painted Glass Top with Bright White Reversed Bevel Edge (G3)

3. Wood Species - Cherry (CH1), Makore (MK2), Maple (MA1) or Walnut (WA1)

4. Wood Finish Options:

Cherry - Flat Cut		Makore - Quarter Cut	
AUT	Autumn	AUT	Autumn
BRL	Barley	BRL	Barley
BBN	Bourbon	BBN	Bourbon
BRG	Brighton	BRG	Brighton
CLA	Classic	CLA	Classic
EAR	Earthy	EAR	Earthy
LGC	Legacy	LGC	Legacy
PRL	Praline	PRL	Praline
SAF	Saffron	SAF	Saffron

4. Wood Finish Options:

Maple - Flat Cut		Walnut - Flat Cut	
ALE	Ale	AUB	Auburn
BUT	Butterscotch	ESP	Espresso
CIN	Cinnamon	MCH	Mocha
FLX	Flax	NTO	Night Owl
VEN	Venetian	SIE	Sienna
		TOF	Toffee
		TRF	Truffle

4. Fabric Selection - Please supply the following:

- Fabric vendor
- Pattern name
- Pattern color

Note: Fabric ran railroaded on cushions.

All COM orders must include the following:

- Vendor's name, pattern name and color
- Sample of the fabric attached to order
- Model numbers of items for fabric application

Special application instructions (e.g., all stripes will be applied front to back unless specified otherwise)
 • Customer and purchase order number

Ship prepaid COM material to:

JSI
 Attn: COM Dept
 932 Mill Street
 Jasper, IN 47546

All COM orders will ship at standard lead time from receipt of COM except for orders requiring special custom matched finishes.

Privacy Screens

Satin White frosted acrylic privacy screens are affixed to other products or available as a freestanding unit.

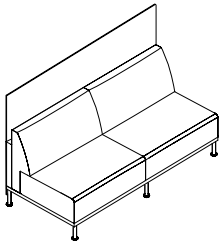

Two Seat with Screen

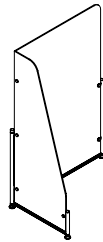

Privacy Screen

Huddle and Meeting Table Tops Styles

The Collective Motion collaborative tables offer three edge details and four top styles. The back painted glass top with “Write-On-It” glossy glass features a white-board and can be written on with erasable white-board markers.

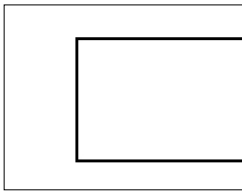

A1

Wood with Straight Edge
standard, no upcharge

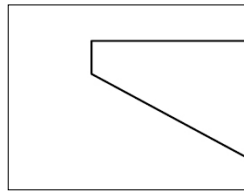

A9

Wood with Reversed
Bevel Edge
no upcharge

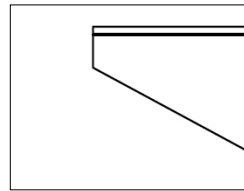

A10

White Laminate Top with Bright
White Reversed Bevel Edge
no upcharge

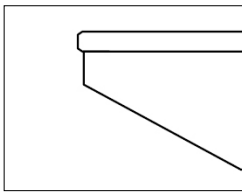

G2

Back Painted Glass Top with
“Write-On-It” Glossy Glass Top
feature with Bright White Reversed
Bevel Edge
add upcharge
(refer to specific models for pricing)

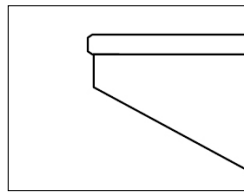

G3

Frosted Back Painted Glass with
Bright White Reversed Bevel Edge
add upcharge
(refer to specific models for pricing)

LOUNGE

Attaching Console Table

The console table attaches effortlessly via a mounting hook which fits snugly between the seat back and the upholstered wrap frame.

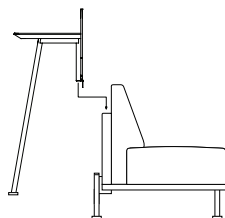
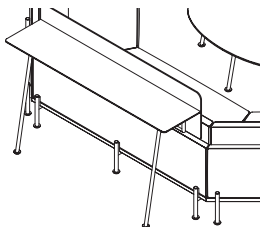

Seating Material Options

This form must accompany order when specifying contrasting or complementary upholstery.

Call for yardage and pricing.

Areas shown in black are maple wood species and requires a finish specification.

Areas (a), (b) and (c) are upholstery and can be specified in contrasting fabric or leather.

Legs, casters and handles are finished in Arctic Silver.

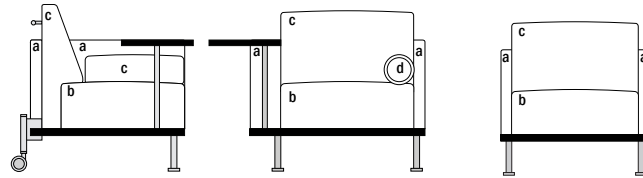

Lounge

Model Number: _____

Finish: _____

Surround (a): _____

Seat (b): _____

Back (c): _____

Bolster (d): _____

photo copy or scan

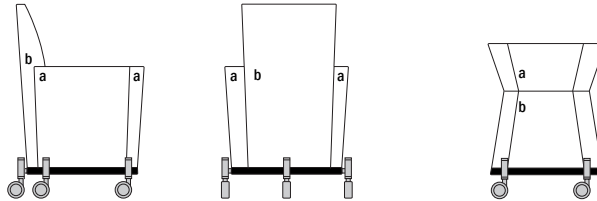

Mobile Stool

Model Number: _____

Finish: _____

Seat/Top (a): _____

Back/Bottom (b): _____

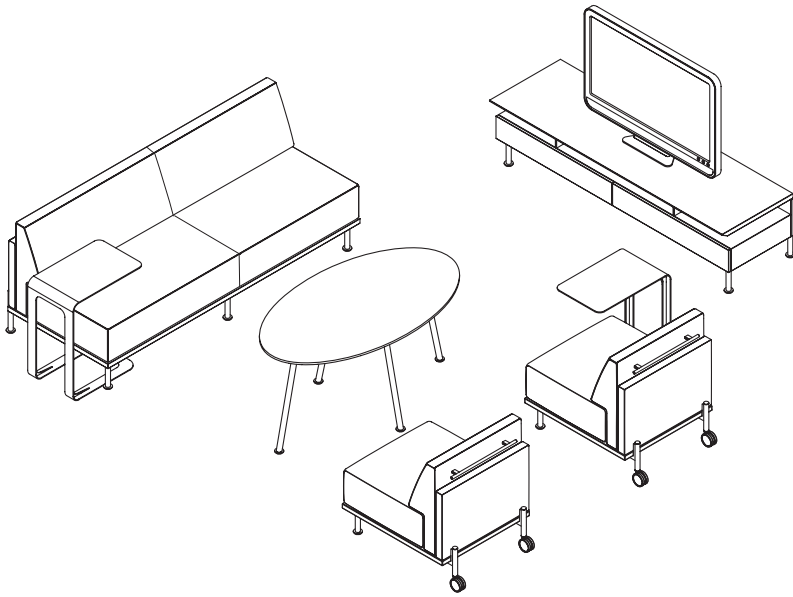

CM-1

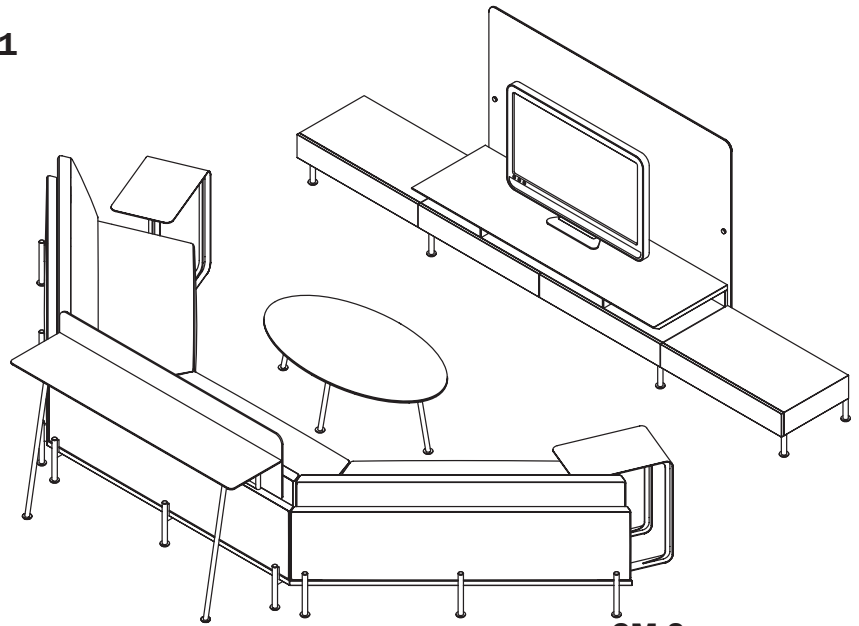

CM-2

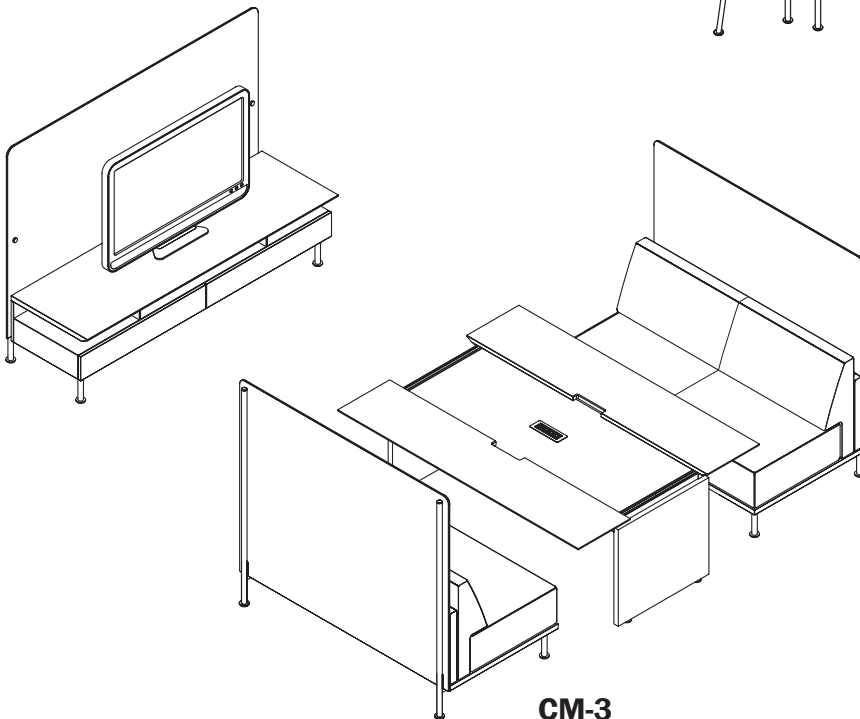

CM-3

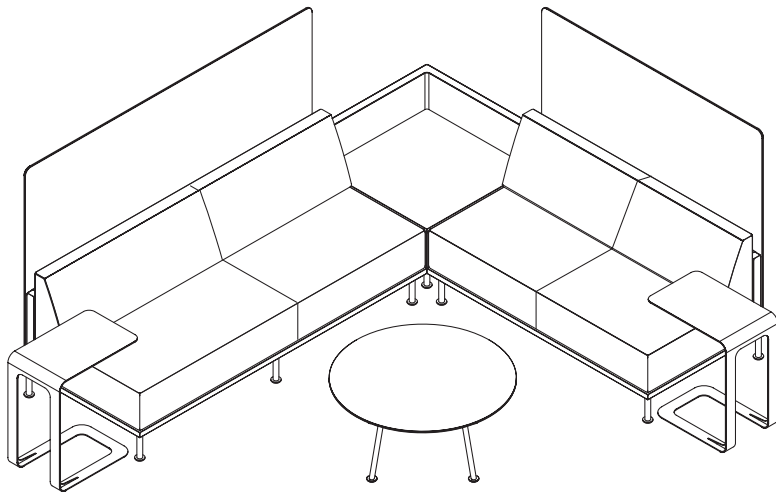

CM-5

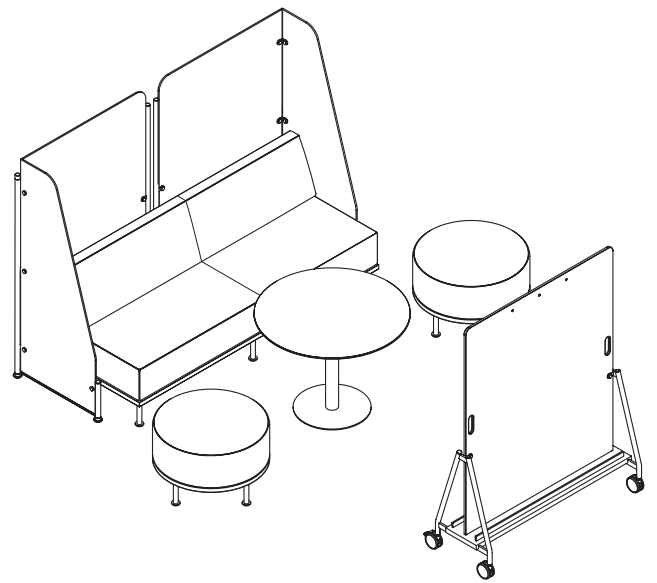

CM-6

LOUNGE

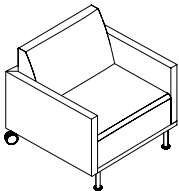
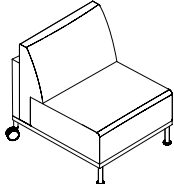
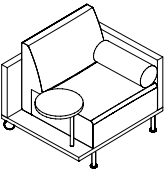
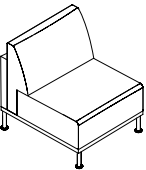
Description	① Model	Specifications	List Price Per Grade																												
Single Seat 	CM4552 · upholstered surround, seat and back · front legs on slides, back legs on casters for easy mobility · upholstered back features handle	<table border="1"> <thead> <tr> <th>Dimensions</th> <th>D</th> <th>W</th> <th>H</th> </tr> </thead> <tbody> <tr> <td>Overall</td> <td>33</td> <td>31 ½</td> <td>32</td> </tr> <tr> <td>Seat</td> <td>20</td> <td>27</td> <td>17 ½</td> </tr> <tr> <td>Arm</td> <td></td> <td></td> <td>26</td> </tr> <tr> <th colspan="2">Upholstery</th> <th colspan="2">Shipping</th> </tr> <tr> <td>COM Ydg</td> <td>6 ½</td> <td>Ctn Wt</td> <td>97</td> </tr> <tr> <td>COL Sq Ft</td> <td>130</td> <td>Cu Ft</td> <td>23</td> </tr> </tbody> </table>	Dimensions	D	W	H	Overall	33	31 ½	32	Seat	20	27	17 ½	Arm			26	Upholstery		Shipping		COM Ydg	6 ½	Ctn Wt	97	COL Sq Ft	130	Cu Ft	23	COM \$2,597 A \$2,655 B \$2,767 COL/C \$2,965 D \$3,219 E \$3,473 F \$3,742 G \$4,123 H \$4,529 I \$5,164 J \$5,927 L1 \$4,402 L2 \$4,859
		Dimensions	D	W	H																										
Overall	33	31 ½	32																												
Seat	20	27	17 ½																												
Arm			26																												
Upholstery		Shipping																													
COM Ydg	6 ½	Ctn Wt	97																												
COL Sq Ft	130	Cu Ft	23																												
Single Seat 	CM4550 · upholstered surround, seat and back · armless · front legs on slides, back legs on casters for easy mobility · upholstered back features handle	<table border="1"> <thead> <tr> <th>Dimensions</th> <th>D</th> <th>W</th> <th>H</th> </tr> </thead> <tbody> <tr> <td>Overall</td> <td>33</td> <td>27</td> <td>32</td> </tr> <tr> <td>Seat</td> <td>20</td> <td>27</td> <td>17 ½</td> </tr> <tr> <th colspan="2">Upholstery</th> <th colspan="2">Shipping</th> </tr> <tr> <td>COM Ydg</td> <td>4 ½</td> <td>Ctn Wt</td> <td>73</td> </tr> <tr> <td>COL Sq Ft</td> <td>90</td> <td>Cu Ft</td> <td>20</td> </tr> </tbody> </table>	Dimensions	D	W	H	Overall	33	27	32	Seat	20	27	17 ½	Upholstery		Shipping		COM Ydg	4 ½	Ctn Wt	73	COL Sq Ft	90	Cu Ft	20	COM \$2,245 A \$2,285 B \$2,363 COL/C \$2,501 D \$2,676 E \$2,852 F \$3,038 G \$3,302 H \$3,583 I \$4,023 J \$4,550 L1 \$3,495 L2 \$3,812				
		Dimensions	D	W	H																										
Overall	33	27	32																												
Seat	20	27	17 ½																												
Upholstery		Shipping																													
COM Ydg	4 ½	Ctn Wt	73																												
COL Sq Ft	90	Cu Ft	20																												
Single Seat  right shown	CM4552R CM4552L · upholstered surround, seat and back · front legs on slides, back legs on casters for easy mobility · upholstered back features handle · asymmetrical pivoting wood tablet · bolster attaches with snap hooks · power/communication module available, specify and add \$521 list each · bolster COM ydg: 1 · bolster COL sq ft: 18	<table border="1"> <thead> <tr> <th>Dimensions</th> <th>D</th> <th>W</th> <th>H</th> </tr> </thead> <tbody> <tr> <td>Overall</td> <td>33</td> <td>35 ¼</td> <td>32</td> </tr> <tr> <td>Seat</td> <td>20</td> <td>27</td> <td>17 ½</td> </tr> <tr> <td>Arm</td> <td></td> <td></td> <td>26</td> </tr> <tr> <th colspan="2">Upholstery</th> <th colspan="2">Shipping</th> </tr> <tr> <td>COM Ydg</td> <td>5 ½</td> <td>Ctn Wt</td> <td>103</td> </tr> <tr> <td>COL Sq Ft</td> <td>110</td> <td>Cu Ft</td> <td>26</td> </tr> </tbody> </table>	Dimensions	D	W	H	Overall	33	35 ¼	32	Seat	20	27	17 ½	Arm			26	Upholstery		Shipping		COM Ydg	5 ½	Ctn Wt	103	COL Sq Ft	110	Cu Ft	26	COM \$2,864 A \$2,912 B \$3,008 COL/C \$3,176 D \$3,390 E \$3,605 F \$3,832 G \$4,154 H \$4,499 I \$5,036 J \$5,681 L1 \$4,392 L2 \$4,778
		Dimensions	D	W	H																										
Overall	33	35 ¼	32																												
Seat	20	27	17 ½																												
Arm			26																												
Upholstery		Shipping																													
COM Ydg	5 ½	Ctn Wt	103																												
COL Sq Ft	110	Cu Ft	26																												
Single Seat 	CM4555 · upholstered surround, seat and back · armless · legs feature slider glides for easy mobility · linking brackets available, specify and add \$73 list · corner table available for linking configurations, see page 190	<table border="1"> <thead> <tr> <th>Dimensions</th> <th>D</th> <th>W</th> <th>H</th> </tr> </thead> <tbody> <tr> <td>Overall</td> <td>33</td> <td>27</td> <td>32</td> </tr> <tr> <td>Seat</td> <td>20 ½</td> <td>27</td> <td>17 ½</td> </tr> <tr> <th colspan="2">Upholstery</th> <th colspan="2">Shipping</th> </tr> <tr> <td>COM Ydg</td> <td>4 ½</td> <td>Ctn Wt</td> <td>79</td> </tr> <tr> <td>COL Sq Ft</td> <td>90</td> <td>Cu Ft</td> <td>20</td> </tr> </tbody> </table>	Dimensions	D	W	H	Overall	33	27	32	Seat	20 ½	27	17 ½	Upholstery		Shipping		COM Ydg	4 ½	Ctn Wt	79	COL Sq Ft	90	Cu Ft	20	COM \$2,556 A \$2,596 B \$2,674 COL/C \$2,811 D \$2,987 E \$3,163 F \$3,349 G \$3,612 H \$3,894 I \$4,334 J \$4,861 L1 \$3,806 L2 \$4,123				
		Dimensions	D	W	H																										
Overall	33	27	32																												
Seat	20 ½	27	17 ½																												
Upholstery		Shipping																													
COM Ydg	4 ½	Ctn Wt	79																												
COL Sq Ft	90	Cu Ft	20																												

LOUNGE

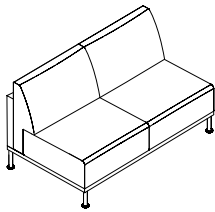
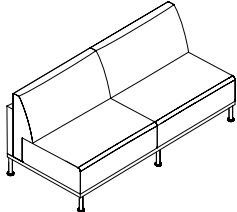
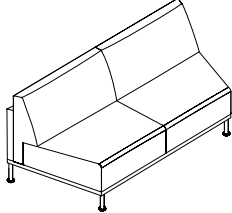
Description	① Model	Specifications	List Price Per Grade												
Two Seat 	CM4575 · upholstered surround, seat and back · armless · legs feature slider glides for easy mobility · linking brackets available, specify and add \$73 list · corner table available for linking configurations, see page 190	<table border="1"> <thead> <tr> <th>Dimensions</th> <th>D</th> <th>W</th> <th>H</th> </tr> </thead> <tbody> <tr> <td>Overall</td> <td>33</td> <td>60</td> <td>32</td> </tr> <tr> <td>Seat</td> <td>20½</td> <td>60</td> <td>17½</td> </tr> </tbody> </table>	Dimensions	D	W	H	Overall	33	60	32	Seat	20½	60	17½	COM \$2,881 A \$2,957 B \$3,110 COL/C \$3,375 D \$3,717 E \$4,060 F \$4,421 G \$4,933 H \$5,481 I \$6,336 J \$7,362 L1 \$5,310 L2 \$5,926
		Dimensions	D	W	H										
Overall	33	60	32												
Seat	20½	60	17½												
<table border="1"> <thead> <tr> <th>Upholstery</th> <th colspan="2">Shipping</th> </tr> </thead> <tbody> <tr> <td>COM Ydg</td> <td>8¾</td> <td>Ctn Wt 145</td> </tr> <tr> <td>COL Sq Ft</td> <td>175</td> <td>Cu Ft 43</td> </tr> </tbody> </table>	Upholstery	Shipping		COM Ydg	8¾	Ctn Wt 145	COL Sq Ft	175	Cu Ft 43						
Upholstery	Shipping														
COM Ydg	8¾	Ctn Wt 145													
COL Sq Ft	175	Cu Ft 43													
Three Seat 	CM4585 · upholstered surround, seat and back · armless · legs feature slider glides for easy mobility · linking brackets available, specify and add \$73 list · corner table available for linking configurations, see page 190	<table border="1"> <thead> <tr> <th>Dimensions</th> <th>D</th> <th>W</th> <th>H</th> </tr> </thead> <tbody> <tr> <td>Overall</td> <td>33</td> <td>78</td> <td>32</td> </tr> <tr> <td>Seat</td> <td>20½</td> <td>78</td> <td>17½</td> </tr> </tbody> </table>	Dimensions	D	W	H	Overall	33	78	32	Seat	20½	78	17½	COM \$3,835 A \$3,914 B \$4,070 COL/C \$4,344 D \$4,696 E \$5,048 F \$5,420 G \$5,947 H \$6,509 I \$7,389 J \$8,445 L1 \$6,334 L2 \$6,967
		Dimensions	D	W	H										
Overall	33	78	32												
Seat	20½	78	17½												
<table border="1"> <thead> <tr> <th>Upholstery</th> <th colspan="2">Shipping</th> </tr> </thead> <tbody> <tr> <td>COM Ydg</td> <td>9</td> <td>Ctn Wt 198</td> </tr> <tr> <td>COL Sq Ft</td> <td>180</td> <td>Cu Ft 55</td> </tr> </tbody> </table>	Upholstery	Shipping		COM Ydg	9	Ctn Wt 198	COL Sq Ft	180	Cu Ft 55						
Upholstery	Shipping														
COM Ydg	9	Ctn Wt 198													
COL Sq Ft	180	Cu Ft 55													
Two Seat Huddle 	CM4572 · upholstered surround, seat and back · armless · legs feature slider glides for easy mobility · seat front width: 46 ⅝" · linking brackets included	<table border="1"> <thead> <tr> <th>Dimensions</th> <th>D</th> <th>W</th> <th>H</th> </tr> </thead> <tbody> <tr> <td>Overall</td> <td>33</td> <td>72</td> <td>32</td> </tr> <tr> <td>Seat</td> <td>20½</td> <td>46½</td> <td>17½</td> </tr> </tbody> </table>	Dimensions	D	W	H	Overall	33	72	32	Seat	20½	46½	17½	COM \$3,544 A \$3,621 B \$3,773 COL/C \$4,039 D \$4,381 E \$4,723 F \$5,085 G \$5,597 H \$6,145 I \$7,000 J \$8,026 L1 \$5,974 L2 \$6,589
		Dimensions	D	W	H										
Overall	33	72	32												
Seat	20½	46½	17½												
<table border="1"> <thead> <tr> <th>Upholstery</th> <th colspan="2">Shipping</th> </tr> </thead> <tbody> <tr> <td>COM Ydg</td> <td>8¾</td> <td>Ctn Wt 178</td> </tr> <tr> <td>COL Sq Ft</td> <td>175</td> <td>Cu Ft 50</td> </tr> </tbody> </table>	Upholstery	Shipping		COM Ydg	8¾	Ctn Wt 178	COL Sq Ft	175	Cu Ft 50						
Upholstery	Shipping														
COM Ydg	8¾	Ctn Wt 178													
COL Sq Ft	175	Cu Ft 50													

To Order, Specify:

- ① Model Number
- ② Wood Species - Maple (M)
- ③ Wood Finish
- ④ Fabric Selection - vendor, pattern and color

③ Wood Finish Options:

ALE Ale	FLX Flax
AUB Auburn	LGC Legacy
AUT Autumn	MCH Mocha
BRL Barley	NTO Night Owl
BBN Bourbon	PRL Praline
BRG Brighton	SAF Saffron
BUT Butterscotch	SIE Sienna
CIN Cinnamon	TOF Toffee
CLA Classic	TRF Truffle
EAR Earthy	VEN Venetian
ESP Espresso	

- ④ See a selection of graded in fabric manufacturers and patterns on pages 12-20. Contact Customer Service for additional fabric options.

Specifications

- Base wood species - Maple.
- Frame interior is upholstery grade plywood with glued solid hardwood cross members reinforced with wood screws.
- Seat has synthetic sheet webbing with cross strap and high resiliency seat polyurethane multi-density foam.
- Back has polypropylene webbing and multi-density polyurethane foam.
- Arctic Silver tubular steel legs.

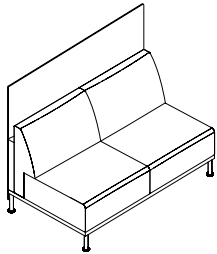
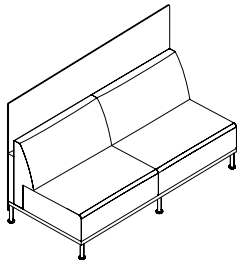
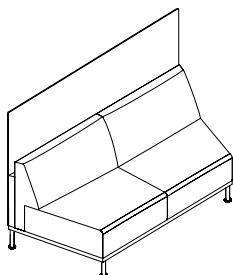
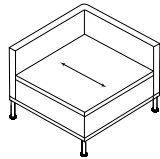
Description	① Model	Specifications	List Price Per Grade												
Two Seat with Fixed Screen 	CM4575-PS · upholstered surround, seat and back · armless · legs feature slider glides for easy mobility	<table border="1"> <thead> <tr> <th>Dimensions</th> <th>D</th> <th>W</th> <th>H</th> </tr> </thead> <tbody> <tr> <td>Overall</td> <td>33</td> <td>60</td> <td>55</td> </tr> <tr> <td>Seat</td> <td>20 ½</td> <td>60</td> <td>17 ½</td> </tr> </tbody> </table>	Dimensions	D	W	H	Overall	33	60	55	Seat	20 ½	60	17 ½	COM \$4,055 A \$4,131 B \$4,283 COL/C \$4,549 D \$4,891 E \$5,234 F \$5,595 G \$6,107 H \$6,655 I \$7,510 J \$8,536 L1 \$6,484 L2 \$7,100
		Dimensions	D	W	H										
Overall	33	60	55												
Seat	20 ½	60	17 ½												
<table border="1"> <thead> <tr> <th>Upholstery</th> <th colspan="3">Shipping</th> </tr> </thead> <tbody> <tr> <td>COM Ydg</td> <td>8 ¾</td> <td>Ctn Wt</td> <td>281</td> </tr> <tr> <td>COL Sq Ft</td> <td>175</td> <td>Cu Ft</td> <td>72</td> </tr> </tbody> </table>	Upholstery	Shipping			COM Ydg	8 ¾	Ctn Wt	281	COL Sq Ft	175	Cu Ft	72			
Upholstery	Shipping														
COM Ydg	8 ¾	Ctn Wt	281												
COL Sq Ft	175	Cu Ft	72												
Three Seat with Fixed Screen 	CM4585-PS · upholstered surround, seat and back · armless · legs feature slider glides for easy mobility · linking brackets available, specify and add \$73 list	<table border="1"> <thead> <tr> <th>Dimensions</th> <th>D</th> <th>W</th> <th>H</th> </tr> </thead> <tbody> <tr> <td>Overall</td> <td>33</td> <td>78</td> <td>55</td> </tr> <tr> <td>Seat</td> <td>20 ½</td> <td>78</td> <td>17 ½</td> </tr> </tbody> </table>	Dimensions	D	W	H	Overall	33	78	55	Seat	20 ½	78	17 ½	COM \$5,009 A \$5,088 B \$5,244 COL/C \$5,518 D \$5,870 E \$6,222 F \$6,593 G \$7,121 H \$7,683 I \$8,563 J \$9,618 L1 \$7,508 L2 \$8,141
		Dimensions	D	W	H										
Overall	33	78	55												
Seat	20 ½	78	17 ½												
<table border="1"> <thead> <tr> <th>Upholstery</th> <th colspan="3">Shipping</th> </tr> </thead> <tbody> <tr> <td>COM Ydg</td> <td>9</td> <td>Ctn Wt</td> <td>325</td> </tr> <tr> <td>COL Sq Ft</td> <td>180</td> <td>Cu Ft</td> <td>93</td> </tr> </tbody> </table>	Upholstery	Shipping			COM Ydg	9	Ctn Wt	325	COL Sq Ft	180	Cu Ft	93			
Upholstery	Shipping														
COM Ydg	9	Ctn Wt	325												
COL Sq Ft	180	Cu Ft	93												
Two Seat Huddle with Fixed Screen 	CM4572-PS · upholstered surround, seat and back · armless · legs feature slider glides for easy mobility · seat front width: 46 ½" · linking brackets included	<table border="1"> <thead> <tr> <th>Dimensions</th> <th>D</th> <th>W</th> <th>H</th> </tr> </thead> <tbody> <tr> <td>Overall</td> <td>33</td> <td>72</td> <td>55</td> </tr> <tr> <td>Seat</td> <td>20 ½</td> <td>46 ½</td> <td>17 ½</td> </tr> </tbody> </table>	Dimensions	D	W	H	Overall	33	72	55	Seat	20 ½	46 ½	17 ½	COM \$4,719 A \$4,796 B \$4,948 COL/C \$5,214 D \$5,556 E \$5,898 F \$6,260 G \$6,772 H \$7,320 I \$8,175 J \$9,201 L1 \$7,149 L2 \$7,764
		Dimensions	D	W	H										
Overall	33	72	55												
Seat	20 ½	46 ½	17 ½												
<table border="1"> <thead> <tr> <th>Upholstery</th> <th colspan="3">Shipping</th> </tr> </thead> <tbody> <tr> <td>COM Ydg</td> <td>8 ¾</td> <td>Ctn Wt</td> <td>304</td> </tr> <tr> <td>COL Sq Ft</td> <td>175</td> <td>Cu Ft</td> <td>86</td> </tr> </tbody> </table>	Upholstery	Shipping			COM Ydg	8 ¾	Ctn Wt	304	COL Sq Ft	175	Cu Ft	86			
Upholstery	Shipping														
COM Ydg	8 ¾	Ctn Wt	304												
COL Sq Ft	175	Cu Ft	86												
Corner Table 	CM4531 · upholstered surround · wood top and chassis · use with units 4555, 4575, 4585 · legs feature slider glides for easy mobility · linking brackets included	<table border="1"> <thead> <tr> <th>Dimensions</th> <th>D</th> <th>W</th> <th>H</th> </tr> </thead> <tbody> <tr> <td>Overall</td> <td>33</td> <td>33</td> <td>26</td> </tr> </tbody> </table>	Dimensions	D	W	H	Overall	33	33	26	COM \$2,862 A \$2,888 B \$2,940 COL/C \$3,032 D \$3,149 E \$3,266 F \$3,390 G \$3,566 H \$3,753 I \$4,047 J \$4,399 L1 \$3,695 L2 \$3,906				
		Dimensions	D	W	H										
Overall	33	33	26												
<table border="1"> <thead> <tr> <th>Upholstery</th> <th colspan="3">Shipping</th> </tr> </thead> <tbody> <tr> <td>COM Ydg</td> <td>3</td> <td>Ctn Wt</td> <td>122</td> </tr> <tr> <td>COL Sq Ft</td> <td>60</td> <td>Cu Ft</td> <td>20</td> </tr> </tbody> </table>	Upholstery	Shipping			COM Ydg	3	Ctn Wt	122	COL Sq Ft	60	Cu Ft	20			
Upholstery	Shipping														
COM Ydg	3	Ctn Wt	122												
COL Sq Ft	60	Cu Ft	20												

LOUNGE

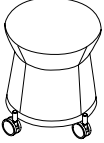
Description	Model	Specifications				List Price Per Grade	
Mini Mobile Stool 	CM4517 · upholstered seat · four casters · non-locking	Dimensions		D	W	H	COM \$1,004
		Overall	18 3/8	18 3/8	20 1/2		
		Upholstery		Shipping			B \$1,038
		COM Ydg	1 1/4	Ctn Wt	31		COL/C \$1,076
		COL Sq Ft	25	Cu Ft	5		D \$1,124
							E \$1,173
							F \$1,225
							G \$1,298
							H \$1,376
							I \$1,499
							J \$1,645
							L1 \$1,352
							L2 \$1,440

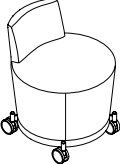
Description	Model	Specifications				List Price Per Grade	
Mini Mobile Stool with Backrest 	CM4519 · upholstered seat and backrest · backrest is 8" high · five casters · non-locking	Dimensions		D	W	H	COM \$1,437
		Overall	22	21	25		
		Seat	16 1/2	21	17		B \$1,489
		Arm					COL/C \$1,550
		Upholstery		Shipping			D \$1,629
		COM Ydg	2	Ctn Wt	35		E \$1,707
		COL Sq Ft	40	Cu Ft	8		F \$1,790
							G \$1,906
							H \$2,031
							I \$2,228
							J \$2,462
							L1 \$1,992
							L2 \$2,133

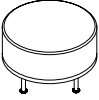
Description	Model	Specifications				List Price Per Grade	
Ottoman 	CM4527 · upholstered seat	Dimensions		D	W	H	COM \$1,375
		Overall	27	27	17 3/4		
		Upholstery		Shipping			B \$1,421
		COM Ydg	1 3/4	Ctn Wt	54		COL/C \$1,475
		COL Sq Ft	35	Cu Ft	9		D \$1,543
							E \$1,611
							F \$1,684
							G \$1,785
							H \$1,896
							I \$2,067
							J \$2,272
							L1 \$1,861
							L2 \$1,984

To Order, Specify:

- 1 Model Number
- 2 Wood Species - Maple (M)
- 3 Wood Finish
- 4 Fabric Selection - vendor, pattern and color

3 Wood Finish Options:

ALE Ale	FLX Flax
AUB Auburn	LGC Legacy
AUT Autumn	MCH Mocha
BRL Barley	NTO Night Owl
BBN Bourbon	PRL Praline
BRG Brighton	SAF Saffron
BUT Butterscotch	SIE Sienna
CIN Cinnamon	TOF Toffee
CLA Classic	TRF Truffle
EAR Earthy	VEN Venetian
ESP Espresso	

- 4 See a selection of graded in fabric manufacturers and patterns on pages 12-20. Contact Customer Service for additional fabric options.

Specifications

- Wood species - Maple.
- Frame interior is upholstery grade plywood with glued solid hardwood cross members reinforced with wood screws.
- Seat has synthetic sheet webbing with cross strap and high resiliency seat polyurethane multi-density foam.
- Back has polypropylene webbing and multi-density polyurethane foam.
- Arctic Silver tubular steel legs.

Description	D	W	H	CTN WT	CU FT	① Model	List Price
Console Table	18	48	29 ½	118	18	OCST4548M-30	\$2,282

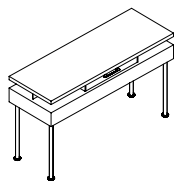

- Maple veneer
- Anodized Aluminum drawer pulls
- casters not available

Coffee Table	42	42	17 ¾	229	21	OCFT4542M-18	\$2,632
	30	30	16 ¾	219	10	OCFT4530M-16	\$1,529

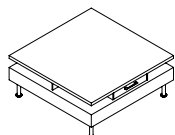

- Maple veneer
- Anodized Aluminum drawer pulls
- power/communication module available, specify and add \$521 list

End Table	20	20	24	207	7	OST4520M-24	\$2,102
-----------	----	----	----	-----	---	-------------	---------

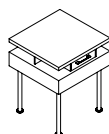

- Maple veneer
- Anodized Aluminum drawer pulls

Coffee Table	36 ¾	36 ¾	16 ¾	103	15	ORT4536M-17	\$3,353
--------------	------	------	------	-----	----	-------------	---------

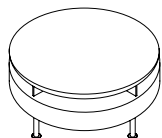

- Maple veneer
- Skirt not available in paint ▲

End Table	20	20	24 ¾	43	7	ORT4520M-24	\$2,907
-----------	----	----	------	----	---	-------------	---------

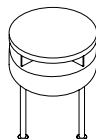

- Maple veneer
- Skirt not available in paint ▲

LOUNGE

To Order, Specify:

- ① Model Number
- ② Wood Species - Maple (MA1)
- ③ Wood Finish
- ④ Skirt Color ▲
 - A. Same as Top
 - B. Paint

③ Wood Finish Options:

ALE Ale	FLX Flax
AUB Auburn	LGC Legacy
AUT Autumn	MCH Mocha
BRL Barley	NTO Night Owl
BBN Bourbon	PRL Praline
BRG Brighton	SAF Saffron
BUT Butterscotch	SIE Sienna
CIN Cinnamon	TOF Toffee
CLA Classic	TRF Truffle
EAR Earthy	VEN Venetian
ESP Espresso	

④ Paint Color Options: ▲

BKD Backdrop	GRV Greek Villa
BFX Black Fox	NET Network Gray
BWH Bright White	NWH Nonchalant White
CGP Cargo Pants	STM Storm
CHT Chatroom	TRC Tricorn Black
FRR French Roast	

Specifications

- Maple veneer exposed wood surfaces.
- Legs feature slider glides for easy mobility.
- Arctic Silver tubular steel legs.

Description	D	W	H	CTN WT	CU FT	❶ Model	List Price
Oval Occasional Table	32	60	18	71	24	OVTL4560-18	

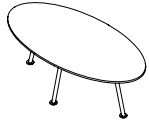

Top Style:

(A1) Wood with Straight Edge	\$1,735
(A9) Wood with Reversed Bevel Edge	\$1,735
(A10) White Laminate Top with Bright White Reversed Bevel Edge	\$1,735
(G2) "Write-On-It" Glossy Glass Top with Bright White Reversed Bevel Edge	\$3,197
(G3) Frosted Glass Top with Bright White Reversed Bevel Edge	\$3,197

Round Occasional Table	36	36	18	56	16	ORTL4536-18	
------------------------	----	----	----	----	----	-------------	--

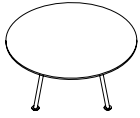

Top Style:

(A1) Wood with Straight Edge	\$1,480
(A9) Wood with Reversed Bevel Edge	\$1,480
(A10) White Laminate Top with Bright White Reversed Bevel Edge	\$1,480
(G2) "Write-On-It" Glossy Glass Top with Bright White Reversed Bevel Edge	\$2,346
(G3) Frosted Glass Top with Bright White Reversed Bevel Edge	\$2,346

Round Occasional Table	30	30	18	53	11	ORTL4530-18	
------------------------	----	----	----	----	----	-------------	--



Top Style:

(A1) Wood with Straight Edge	\$1,405
(A9) Wood with Reversed Bevel Edge	\$1,405
(A10) White Laminate Top with Bright White Reversed Bevel Edge	\$1,405
(G2) "Write-On-It" Glossy Glass Top with Bright White Reversed Bevel Edge	\$2,127
(G3) Frosted Glass Top with Bright White Reversed Bevel Edge	\$2,127

To Order, Specify:

- ❶ Model Number
- ❷ Top Style
- ❸ Wood Species - Cherry (CH1), Makore (MK2), Maple (MA1) or Walnut (WA1)
- ❹ Wood Finish

❸ Wood Finish Options:

Cherry - Flat Cut		Makore - Quarter Cut	
AUT	Autumn	AUT	Autumn
BRL	Barley	BRL	Barley
BBN	Bourbon	BBN	Bourbon
BRG	Brighton	BRG	Brighton
CLA	Classic	CLA	Classic
EAR	Earthy	EAR	Earthy
LGC	Legacy	LGC	Legacy
PRL	Praline	PRL	Praline
SAF	Saffron	SAF	Saffron
Maple - Flat Cut		Walnut - Flat Cut	
ALE	Ale	AUB	Auburn
BUT	Butterscotch	ESP	Espresso
CIN	Cinnamon	MCH	Mocha
FLX	Flax	NTO	Night Owl
VEN	Venetian	SIE	Sienna
		TOF	Toffee
		TRF	Truffle

Specifications

- Tops available in Cherry, Makore, Maple or Walnut veneer.
- Legs feature slider glides for easy mobility.
- Arctic Silver tubular steel legs.

Description	D	W	H	CTN WT	CU FT	① Model	List Price
Console Table	16 1/2	60	42 3/8	80	28	CC-HCH4572	

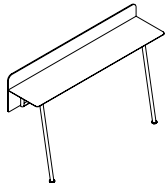

Top Style:

(A1) Wood with Straight Edge	\$2,751
(A9) Wood with Reversed Bevel Edge	\$2,751
(A10) White Laminate Top with Bright White Reversed Bevel Edge	\$2,751
(G2) "Write-On-It" Glossy Glass Top with Bright White Reversed Bevel Edge	\$3,520
(G3) Frosted Glass Top with Bright White Reversed Bevel Edge	\$3,520

- use with lounge units without screens: 4575, 4585, 4572
- table top depth: 15"
- table height: 36 3/8"
- screen height: 16"

27" H Rectangular Huddle Table	30	60	27	86	33	CC-HDTREC4560-27	
--------------------------------	----	----	----	----	----	------------------	--

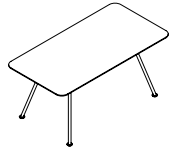

Top Style:

(A1) Wood with Straight Edge	\$2,099
(A9) Wood with Reversed Bevel Edge	\$2,099
(A10) White Laminate Top with Bright White Reversed Bevel Edge	\$2,099
(G2) "Write-On-It" Glossy Glass Top with Bright White Reversed Bevel Edge	\$3,727
(G3) Frosted Glass Top with Bright White Reversed Bevel Edge	\$3,727

Oval Huddle Table	32	60	27	78	35	CC-HDTO4560-27	
-------------------	----	----	----	----	----	----------------	--



Top Style:

(A1) Wood with Straight Edge	\$2,076
(A9) Wood with Reversed Bevel Edge	\$2,076
(A10) White Laminate Top with Bright White Reversed Bevel Edge	\$2,076
(G2) "Write-On-It" Glossy Glass Top with Bright White Reversed Bevel Edge	\$3,538
(G3) Frosted Glass Top with Bright White Reversed Bevel Edge	\$3,538

LOUNGE

Description	D	W	H	CTN WT	CU FT	① Model	List Price
Round Huddle Table	36	36	27	79	24	CC-HDTR4536-27	

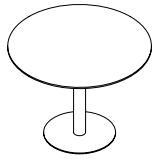

Top Style:

(A1) Wood with Straight Edge	\$1,559
(A9) Wood with Reversed Bevel Edge	\$1,559
(A10) White Laminate Top with Bright White Reversed Bevel Edge	\$1,559
(G2) "Write-On-It" Glossy Glass Top with Bright White Reversed Bevel Edge	\$2,425
(G3) Frosted Glass Top with Bright White Reversed Bevel Edge	\$2,425

- slider glides for easy mobility
- Arctic Silver base finish

Round Huddle Table	30	30	27	77	17	CC-HDTR4530-27	
--------------------	----	----	----	----	----	----------------	--

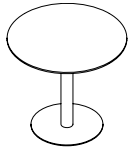

Top Style:

(A1) Wood with Straight Edge	\$1,477
(A9) Wood with Reversed Bevel Edge	\$1,477
(A10) White Laminate Top with Bright White Reversed Bevel Edge	\$1,477
(G2) "Write-On-It" Glossy Glass Top with Bright White Reversed Bevel Edge	\$2,198
(G3) Frosted Glass Top with Bright White Reversed Bevel Edge	\$2,198

- slider glides for easy mobility
- Arctic Silver base finish

Quad Huddle Table	40	40	27	110	29	CC-HPT4540-27	
-------------------	----	----	----	-----	----	---------------	--

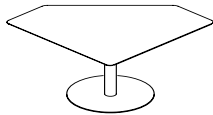

Top Style:

(A1) Wood with Straight Edge	\$1,698
(A9) Wood with Reversed Bevel Edge	\$1,698
(A10) White Laminate Top with Bright White Reversed Bevel Edge	\$1,698

- slider glides for easy mobility
- Arctic Silver base finish

To Order, Specify:

- ① Model Number
- ② Top Style
- ③ Wood Species - Cherry (CH1), Makore (MK2), Maple (MA1) or Walnut (WA1)
- ④ Wood Finish

③ Wood Finish Options:

Cherry - Flat Cut	Makore - Quarter Cut
AUT Autumn	AUT Autumn
BRL Barley	BRL Barley
BBN Bourbon	BBN Bourbon
BRG Brighton	BRG Brighton
CLA Classic	CLA Classic
EAR Earthy	EAR Earthy
LGC Legacy	LGC Legacy
PRL Praline	PRL Praline
SAF Saffron	SAF Saffron
Maple - Flat Cut	Walnut - Flat Cut
ALE Ale	AUB Auburn
BUT Butterscotch	ESP Espresso
CIN Cinnamon	MCH Mocha
FLX Flax	NTO Night Owl
VEN Venetian	SIE Sienna
	TOF Toffee
	TRF Truffle

Specifications

- Tops available in Cherry, Makore, Maple or Walnut veneer.
- Slider glides for easy mobility.
- Arctic Silver base finish.

Description	D	W	H	CTN WT	CU FT	① Model	List Price
Meeting Table with Expandable Worksurface	30	69	27	302	38	CC-SMT4569	

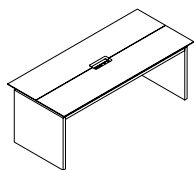

Top Style:

(A1) Wood with Straight Edge	\$9,385
(A9) Wood with Reversed Bevel Edge	\$9,385
(A10) White Laminate Top with Bright White Reversed Bevel Edge	\$9,385

- veneer bases
- adjustable glides
- White interior laminate
- power port with (2) 120 volt outlets and (2) USB ports
- not available with glass top

Meeting Table	30	69	27	231	38	CC-FMT4569	
---------------	----	----	----	-----	----	------------	--

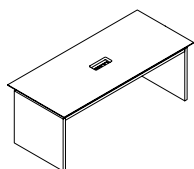

Top Style:

(A1) Wood with Straight Edge	\$4,762
(A9) Wood with Reversed Bevel Edge	\$4,762
(A10) White Laminate Top with Bright White Reversed Bevel Edge	\$4,762

- veneer bases
- adjustable glides
- power port with (2) 120 volt outlets and (2) USB ports
- not available with glass top

72" W Meeting Table	36	72	29	69	50	CC-HDTREC4572-29	
---------------------	----	----	----	----	----	------------------	--

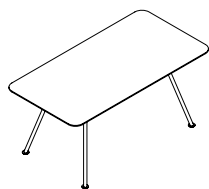

Top Style:

(A1) Wood with Straight Edge	\$2,204
(A9) Wood with Reversed Bevel Edge	\$2,204
(A10) White Laminate Top with Bright White Reversed Bevel Edge	\$2,204
(G2) "Write-On-It" Glossy Glass Top with Bright White Reversed Bevel Edge	\$4,040
(G3) Frosted Glass Top with Bright White Reversed Bevel Edge	\$4,040

- tubular steel legs

Round Meeting Table	36	36	29	69	25	CC-HDTR4536-29	
---------------------	----	----	----	----	----	----------------	--

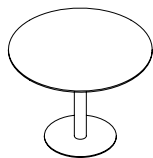

Top Style:

(A1) Wood with Straight Edge	\$1,717
(A9) Wood with Reversed Bevel Edge	\$1,717
(A10) White Laminate Top with Bright White Reversed Bevel Edge	\$1,717
(G2) "Write-On-It" Glossy Glass Top with Bright White Reversed Bevel Edge	\$2,726
(G3) Frosted Glass Top with Bright White Reversed Bevel Edge	\$2,726

LOUNGE

Description	D	W	H	CTN WT	CU FT	① Model	List Price
Media Console	23 1/4	72	20 1/4	223	23	CC-MCS4572	

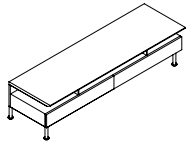

Top Style:

(A1) Wood with Straight Edge	\$2,679
(A9) Wood with Reversed Bevel Edge	\$2,679
(A10) White Laminate Top with Bright White Reversed Bevel Edge	\$2,679
(G2) "Write-On-It" Glossy Glass Top with Bright White Reversed Bevel Edge	\$4,156
(G3) Frosted Glass Top with Bright White Reversed Bevel Edge	\$4,156

- tubular steel legs
- drawer dimensions (2): 32 1/2" W x 15" D

Media Console with Screen	24 5/8	72	54	249	62	CC-MCS4572-PS	
---------------------------	--------	----	----	-----	----	---------------	--

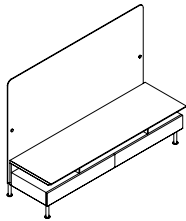

Top Style:

(A1) Wood with Straight Edge	\$3,852
(A9) Wood with Reversed Bevel Edge	\$3,852
(A10) White Laminate Top with Bright White Reversed Bevel Edge	\$3,852
(G2) "Write-On-It" Glossy Glass Top with Bright White Reversed Bevel Edge	\$5,395
(G3) Frosted Glass Top with Bright White Reversed Bevel Edge	\$5,395

- tubular steel legs
- drawer dimensions (2): 32 1/2" W x 15" D

To Order, Specify:

- ① Model Number
- ② Top Style
- ③ Wood Species - Cherry (CH1), Makore (MK2), Maple (MA1) or Walnut (WA1)
- ④ Wood Finish
- ⑤ Cabinet/Drawer Front Color ▲
 - A. Veneer
 - B. Paint

③ Wood Finish Options:

Cherry - Flat Cut	Makore - Quarter Cut
AUT Autumn	AUT Autumn
BRL Barley	BRL Barley
BBN Bourbon	BBN Bourbon
BRG Brighton	BRG Brighton
CLA Classic	CLA Classic
EAR Earthy	EAR Earthy
LGC Legacy	LGC Legacy
PRL Praline	PRL Praline
SAF Saffron	SAF Saffron
Maple - Flat Cut	Walnut - Flat Cut
ALE Ale	AUB Auburn
BUT Butterscotch	ESP Espresso
CIN Cinnamon	MCH Mocha
FLX Flax	NTO Night Owl
VEN Venetian	SIE Sienna
	TOF Toffee
	TRF Truffle

④ Paint Color Options: ▲

BKD Backdrop	GRV Greek Villa
BFX Black Fox	NET Network Gray
BWH Bright White	NWH Nonchalant White
CGP Cargo Pants	STM Storm
CHT Chatroom	TRC Tricorn Black
FRR French Roast	

Specifications

- Tops available in Cherry, Makore, Maple or Walnut veneer.
- Slider glides for easy mobility.
- Arctic Silver base finish.

Description	D	W	H	CTN WT	CU FT	Model	List Price No Cushion	List Price With Cushion
Media Ender	22 3/8	36	15	74	9	CC-MCS4536R	\$1,417	COM \$1,417
	22 3/8	36	15	74	9	CC-MCS4536L	\$1,417	A \$1,431 B \$1,457 COL/C \$1,502 D \$1,561 E \$1,620 F \$1,682 G \$1,770 H \$1,863 I \$2,010 J \$2,186 L1 \$1,834 L2 \$1,940

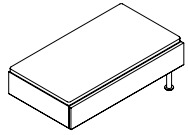

right shown with optional cushion

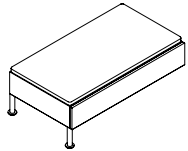

left shown with optional cushion

- available in Cherry, Makore, Maple, Walnut or Paint ▲
- Arctic Silver tubular legs
- optional cushion has polyurethane foam
- use with media console
- drawer
- legs feature slider glides for easy mobility
- optional cushion
- com ydg: 1 1/2
- col sq ft: 30

Description	D	W	H	CTN WT	CU FT	① Model	List Price
Mobile Markerboard	20 ¾	50 ½	66	118	45	CC-MWB4566	\$3,395

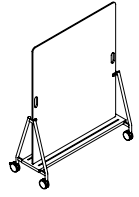

- dry erase laminate
- marker rail available in Cherry, Makore, Maple and Walnut veneer
- Arctic Silver powder coat bases
- two locking and two non-locking casters
- board is not magnetic

Privacy Screen	25 ⅞	41 ⅞	63 ¼	100	44	CC-SPS4563R	\$4,209
	25 ⅞	41 ⅞	63 ¼	100	44	CC-SPS4563L	\$4,209

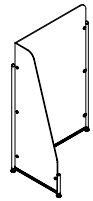

left shown

- Satin White acrylic
- legs feature slider glides for easy mobility
- Arctic Silver tubular steel legs
- ships KD
- NOTE: It is recommended other furniture be used around the screen to prevent tipping. Screens are not designed to support the weight of items hanging or leaning against them

Pull-Up Tablet Table	22	14	26	20	6	CC-TT4522	\$2,088
-----------------------------	----	----	----	----	---	------------------	----------------

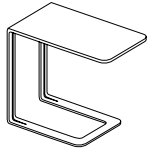

- veneer top face available in Cherry, Makore, Maple or Walnut
- slider glides for easy mobility
- inside of aluminum frame is white powder coat

To Order, Specify:

- ① Model Number
- ② Wood Species - Cherry (CH1), Makore (MK2), Maple (MA1), Walnut (WA1) or Paint (PNT)
- ③ Wood or Paint Finish ▲
- ④ Fabric Selection - vendor, pattern and color

③ Wood Finish Options:

Cherry - Flat Cut

AUT Autumn
BRL Barley
BBN Bourbon
BRG Brighton
CLA Classic
EAR Earthy
LGC Legacy
PRL Praline
SAF Saffron

Maple - Flat Cut

ALE Ale
BUT Butterscotch
CIN Cinnamon
FLX Flax
VEN Venetian

Makore - Quarter Cut

AUT Autumn
BRL Barley
BBN Bourbon
BRG Brighton
CLA Classic
EAR Earthy
LGC Legacy
PRL Praline
SAF Saffron

Walnut - Flat Cut

AUB Auburn
ESP Espresso
MCH Mocha
NTO Night Owl
SIE Sienna
TOF Toffee
TRF Truffle

④ Paint Color Options: ▲

BKD Backdrop	GRV Greek Villa
BFX Black Fox	NET Network Gray
BWH Bright White	NWH Nonchalant White
CGP Cargo Pants	STM Storm
CHT Chatroom	TRC Tricorn Black
FRR French Roast	

- ⑤ See a selection of graded in fabric manufacturers and patterns on pages 12-20. Contact Customer Service for additional fabric options.

Connect Modular Lounge Order Check List:



Specify:

- 1. Model Number
- 2. Wood Species - Cherry (CH1), Maple (MA1) or Walnut (WA1)
- 3. Wood Finish
- 4. Laminate Color Selection (Stand up Surface)
- 5. Fabric Selection
 - A. Seat - Vendor, Pattern and Color
 - B. Back - Vendor, Pattern and Color
 - C. Arm(s) - Vendor, Pattern and Color
 - D. Headrest - Vendor, Pattern and Color
- 6. Metal Leg Color - Black Sandtex (BSX), Soft Nickel (SNK) or Stardust Silver (STS)
- 7. Optional Wood Back Rail - available on any unit with two arms, specify and add \$136 list
- 8. Optional Power Center - Flush Mount (EC22) - Black (B) or White (W); add \$504 list each and indicate left or right arm, end table, center console, linking table or unit with stand up surface
- 9. Optional Drink Holder (DH):
 - one drink holder available per arm; add \$84 list each and indicate left or right arm
 - end tables, console or linking tables available with two drink holders; add \$168 list
- 10. Optional Tablet Arm - indicate left (TBL) or right arm (TBR); add \$476 list
- 11. Product Options

Example:

CTL1304UR (model #)	WA1 (wood species)	ESP (finish)	ALB (stand up surface laminate)	MOMENTUM (fabric vendor)	VOX (pattern name)	MYSTIC (pattern color)	SR (metal leg color)
-------------------------------	------------------------------	------------------------	---	------------------------------------	------------------------------	----------------------------------	--------------------------------

1. Model Number

2. Wood Species - Cherry (CH1), Maple (MA1) or Walnut (WA1)

3. Wood Finish Options:

Cherry

AUT	Autumn*	EAR	Earthy
BRL	Barley*	LGC	Legacy*
BBN	Bourbon*	PRL	Praline*
BRG	Brighton*	SAF	Saffron*
CLA	Classic*		

Maple

ALE	Ale*	FLX	Flax
BUT	Butterscotch	VEN	Venetian*
CIN	Cinnamon*		

Walnut

AUB	Auburn*	TOF	Toffee*
ESP	Espresso	TRF	Truffle*
MCH	Mocha*	SIE	Sienna*
NTO	Night Owl*		

4. Laminate Color Selection (Stand up Surface):

ALB	Alabaster	SHD	Shadow
BBL	Bridal Blanco	SLG	Slate Grey
DWH	Designer White	TAU	Taupe
DOV	Dove Grey		

5. Fabric Selection - Please supply the following:

- Fabric vendor
- Pattern name
- Pattern color

Contrasting Upholstery - Units can be specified with a contrasting upholstery feature. When this feature is desired the unit will be

priced based on the higher grade fabric selected for the seat, back, arm(s) and headrest.

When specifying contrasting upholstery, indicate clearly which upholstery to be applied to the seat, back, arms and headrest.

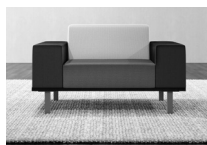

- Indicate direction of fabric - Railroaded or Up the Roll
- Please provide illustration, if available

All COM orders must include the following:

- Vendor's name, pattern name and color
- Sample of the fabric attached to order
- Model numbers of items for fabric application
- Special application instructions (e.g., all stripes will be applied front to back unless specified otherwise)
- Customer and purchase order number

Ship prepaid COM material to:
 JSI
 Attn: COM Dept
 932 Mill Street
 Jasper, IN 47546

Application of fabric:
 Railroaded Up the Roll

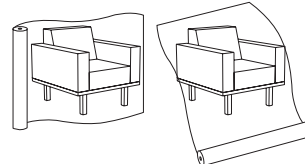

All COM orders will ship at standard lead time from receipt of COM except for orders requiring special custom matched finishes.

continued

Connect Modular Lounge Order Check List (cont.):

6. Metal Leg Color:

Available in Black Sandtex (BSX), Soft Nickel (SNK) or Stardust Silver (STS) powdercoat.

7. Wood Back Rail



For added elegance Connect Low Back units with two arms may be specified with the Wood Back Rail option. The 6" tall wood back rail enhances the back detail as you approach the units from the rear making this a nice feature for "freestanding" applications. This option reduces the back depth by 1 1/8". The back rail will be in the same finish color as the rest of the unit. Specify Wood Back Rail and add \$136 list per unit.

8. Power Center - Flush Mount:



Units with arms, end table, console, linking table or stand up surface can be specified with the Power Center Flush Mount option featuring two waterproof 110 outlets and one dual USB port. Power is connected to the building supply with a 10' long standard three prong cord. Access and storage of excess power cords is provided in the base of the arm or console. Power Center is not available on Corner Seats or Corner Tables.

Power Center (EC22):

- Left or right arm with one Power Center per arm mounted vertically in the front; add \$504 list each, indicate left or right arm (as seated)
- End, console, straight or wedge linking table with one Power Center mounted front to back in top; add \$504 list each
- Single seat unit with a stand up surface and one Power Center located 7 1/4" under the surface and centered in the back; add \$504 list
- Two seat units with a stand up surface and two Power Centers located 7 1/4" under the surface and centered in each back; add \$1,008 list
- Three seat units with a stand up surface and two Power Centers located 7 1/4" under the surface and centered in the back of the left and right backs; add \$1,008 list

NOTE: Power Center color, Black (B) or White (W) must be specified.

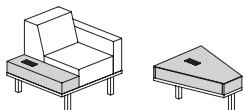
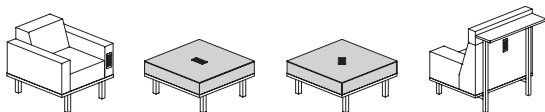

Power Center (EC21) - Under Mount:

This accessory item featuring one 110 volt power receptacle and one dual USB port mounts to the underside of units. See page 274 for additional information.



9. Drink Holder



Units with an arm, end table, console or linking table can be specified with the drink holder option. The drink holder features a plastic base with rubber coaster and a metal trim cap.

Drink Holder (DH):

- Left or right arm with one drink holder per arm; add \$84 list each and indicate left or right arm as seated)
- End table, console or linking table with two drink holders; add \$168 list

NOTE: Metal trim cap color will match the Metal Leg Color. Drink holder cannot be ordered on an arm with a tablet arm.

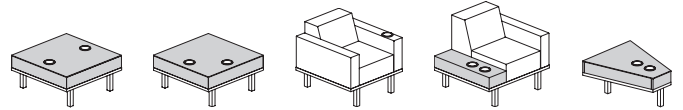
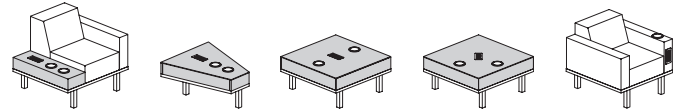

Table Power Center and Drink Holder Standard Locations:



10. Tablet Arm:



- rotating
- 10" x 18" veneer surface
- Specify Tablet Arm option left (TBL) or right (TBR) and add \$476 list for each tablet arm specified

11. Product Options: ▲

Optional Coordinating Wood Grain Laminate Surfaces:

No additional upcharge. Finishes with an asterisk (*) have a coordinating laminate available.

(For wood cap arm, tables or tablet arm)

Optional Nylon Glides: No additional upcharge

Special Finish: \$289 list upcharge

continued

Connect Modular Lounge Order Check List (cont.):

Features:

- 20" and 30" seat widths
- four back heights available on units with a 30" seat width
- arm models with a 20" seat width have an arm width of 5"
- arm models with a 30" seat width have an arm width of 10"
- all units have a 1 1/4" wood base platform
- end table, console and linking tables are made of plywood construction with maple veneer surface
- metal legs are 1 3/4" x 1 3/4" x 8 1/4" 16 guage steel tube with metal leveling glides

Linking Brackets:



Each unit ships with two sets of link brackets; two latches and two hooks providing quick connection to form limitless configurations.

Contrasting Upholstery:



Units can be specified with a contrasting upholstery feature. When this feature is desired the unit **will be priced based on the highest grade fabric** selected for the seat, back, arm(s) or headrest. Specify the seat (A), back (B), arm (C) and headrest (D) fabric on your order.

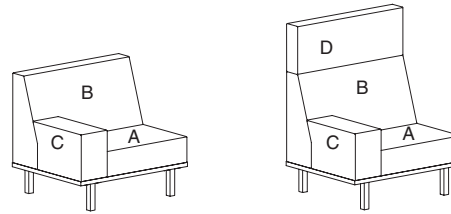

Planning Section:

Modularity:

Modularity and versatility allows you to fit Connect into any footprint using large and small scale components or a mix of both. The use of wider and fewer units will diminish the number of legs in a configuration. More units shorter in width will increase the number of legs in a configuration.

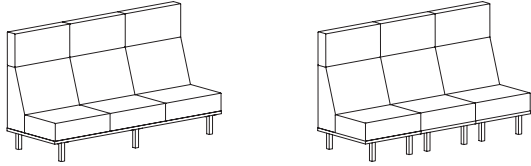

Curved Units:

Curved units in varying radius degrees are available to help aid in creating configurations with different twists and turns. Typicals showing each of these units in a semi-circular configuration are shown on pages 212–217.

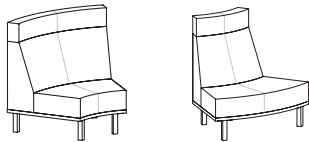

Back Heights:

Units with a 20" seat width are available with low back height or bench style.

Units with a 30" seat width are available in bench style or four different back heights; low, mid, high and privacy. 7" and 14" headrest are included on the High and Privacy back respectively.

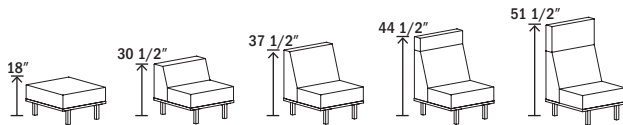

Complementary Components

Units with a 30" seat width and a high or privacy back are available with a 10" deep stand up laminate surface with a coordinating 3mm PVC edge. These surfaces may be used as touch down spaces or to provide tiered type seating.

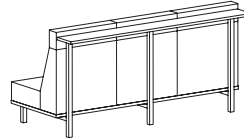

Laminate Color Selection for Stand Up Surface:

ALB	Alabaster	SHD	Shadow
BBL	Bridal Blanco	SLG	Slate Grey
DWH	Designer White	TAU	Taupe
DOV	Dove Grey		

Media Cabinets

20" deep x 60" wide straight and curved Media Cabinets with and without acrylic screens can be used for presentation and training sessions. 20" deep straight and curved media benches are available to compliment the configuration.

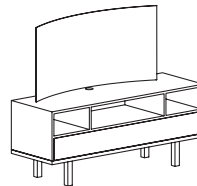

Media Activity Center

For meetings and presentations with an overall footprint of 60" x 72" or 60" x 84", the Media Activity Center is available with either a bullet or rectangular shaped top. These units may also be ordered with or without a back panel. The back panel feature includes a TV mount. For all of your media collaboration needs the DropShare unit can be ordered. DropShare is sold separately, see page 274.

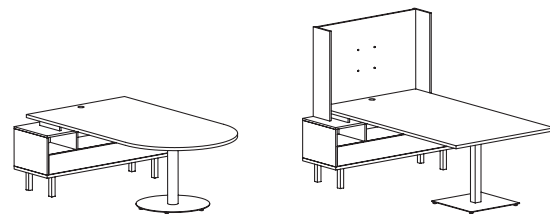

COM Yardage Requirements for Multiple Fabrics

Model	Description	Seat Only COM Ydg	Back Only COM Ydg	Arm Only COM Ydg	Headrest Only COM Ydg
CTC20S1UC	Corner Seat Low Back, Center	1.00	3.00		
CTC20S1UL	Corner Seat Low Back, Left	1.00	3.00		
CTC20S1UR	Corner Seat Low Back, Right	1.00	3.00		
CTC20S2UC	Corner Seat Mid Back, Center	1.00	3.50		
CTC20S2UL	Corner Seat Mid Back, Left	1.00	3.50		
CTC20S2UR	Corner Seat Mid Back, Right	1.00	3.50		
CTC20S3UC	Corner Seat High Back, Center	1.00	3.50		1.75
CTC20S3UL	Corner Seat High Back, Left	1.00	3.50		1.75
CTC20S3UR	Corner Seat High Back, Right	1.00	3.50		1.75
CTC20S4UC	Corner Seat High Back, Center	1.00	3.50		1.75
CTC20S4UL	Corner Seat High Back, Left	1.00	3.50		1.75
CTC20S4UR	Corner Seat High Back, Right	1.00	3.50		1.75
CTC20S5UC	Corner Seat Privacy Back, Center	1.00	3.50		2.50
CTC20S5UL	Corner Seat Privacy Back, Left	1.00	3.50		2.50
CTC20S5UR	Corner Seat Privacy Back, Right	1.00	3.50		2.50
CTC20S6UC	Corner Seat Privacy Back, Center	1.00	3.50		2.50
CTC20S6UL	Corner Seat Privacy Back, Left	1.00	3.50		2.50
CTC20S6UR	Corner Seat Privacy Back, Right	1.00	3.50		2.50
CTC20T2UC	Corner Table Mid Back, Center	1.25	3.50		
CTC20T2UL	Corner Table Mid Back, Left	1.25	3.50		
CTC20T2UR	Corner Table Mid Back, Right	1.25	3.50		
CTC20T2W	Corner Table Mid Back	0.75	3.50		
CTC20T3UC	Corner Table High Back, Center	1.25	3.50		1.75
CTC20T3UL	Corner Table High Back, Left	1.25	3.50		1.75
CTC20T3UR	Corner Table High Back, Right	1.25	3.50		1.75
CTC20T3W	Corner Table High Back	0.75	3.50		1.75
CTC20T4UC	Corner Table High Back, Center	1.25	3.50		1.75
CTC20T4UL	Corner Table High Back, Left	1.25	3.50		1.75
CTC20T4UR	Corner Table High Back, Right	1.25	3.50		1.75
CTC20T4W	Corner Table High Back	0.75	3.50		1.75
CTC20T5UC	Corner Table Privacy Back, Center	1.25	3.50		2.50
CTC20T5UL	Corner Table Privacy Back, Left	1.25	3.50		2.50
CTC20T5UR	Corner Table Privacy Back, Right	1.25	3.50		2.50
CTC20T5W	Corner Table Privacy Back	0.75	3.50		2.50
CTC20T6UC	Corner Table Privacy Back, Center	1.25	3.50		2.50
CTC20T6UL	Corner Table Privacy Back, Left	1.25	3.50		2.50
CTC20T6UR	Corner Table Privacy Back, Right	1.25	3.50		2.50
CTC20T6W	Corner Table Privacy Back	0.75	3.50		2.50
CTI32121	90° Curved Seat Low Back	1.50	4.00		
CTI32122	90° Curved Seat Mid Back	1.50	4.75		
CTI32123	90° Curved Seat High Back	1.50	4.75		1.75
CTI32124	90° Curved Seat High Back	1.50	4.75		1.75
CTI32125	90° Curved Seat Privacy Back	1.50	4.75		2.75
CTI32126	90° Curved Seat Privacy Back	1.50	4.75		2.75
CTI32301	45° Curved Seat Low Back	1.50	2.50		
CTI32302	45° Curved Seat Mid Back	1.50	2.75		
CTI32303	45° Curved Seat High Back	1.50	2.75		1.50
CTI32304	45° Curved Seat High Back	1.50	2.75		1.50
CTI32305	45° Curved Seat Privacy Back	1.50	2.75		2.00
CTI32306	45° Curved Seat Privacy Back	1.50	2.75		2.00
CTI32451	45° Curved Seat Low Back	1.75	3.33		
CTI32452	45° Curved Seat Mid Back	1.75	3.75		
CTI32453	45° Curved Seat High Back	1.75	3.75		1.75
CTI32454	45° Curved Seat High Back	1.75	3.75		1.75
CTI32455	45° Curved Seat Privacy Back	1.75	3.75		2.75
CTI32456	45° Curved Seat Privacy Back	1.75	3.75		2.75
CTL1201	Single Seat Low Back	2.00	1.50		
CTL1201CL	Single Seat Low Back, Left	2.00	1.50		
CTL1201CR	Single Seat Low Back, Right	2.00	1.50		
CTL1201U2	Single Seat Low Back	2.00	1.50	3.00	
CTL1201UL	Single Seat Low Back, Left	2.00	1.50	1.50	
CTL1201ULCR	Single Seat Low Back, Left	2.00	1.50	1.50	
CTL1201UR	Single Seat Low Back, Right	2.00	1.50	1.50	
CTL1201URCL	Single Seat Low Back, Right	2.00	1.50	1.50	
CTL1201W2	Single Seat Low Back	2.00	1.50	3.00	
CTL1201WL	Single Seat Low Back, Left	2.00	1.50	1.50	
CTL1201WLCR	Single Seat Low Back, Left	2.00	1.50	1.50	

Model	Description	Seat Only COM Ydg	Back Only COM Ydg	Arm Only COM Ydg	Headrest Only COM Ydg
CTL1201WR	Single Seat Low Back, Right	2.00	1.50	1.50	
CTL1201WRCL	Single Seat Low Back, Right	2.00	1.50	1.50	
CTL1301	Single Seat Low Back	2.00	1.50		
CTL1301CL	Single Seat Low Back, Left	2.00	1.50		
CTL1301CR	Single Seat Low Back, Right	2.00	1.50		
CTL1301U2	Single Seat Low Back	2.00	1.50	3.00	
CTL1301UL	Single Seat Low Back, Left	2.00	1.50	1.50	
CTL1301ULCR	Single Seat Low Back, Left	2.00	1.50	1.50	
CTL1301UR	Single Seat Low Back, Right	2.00	1.50	1.50	
CTL1301URCL	Single Seat Low Back, Right	2.00	1.50	1.50	
CTL1301W2	Single Seat Low Back	2.00	1.50	3.00	
CTL1301WL	Single Seat Low Back, Left	2.00	1.50	1.50	
CTL1301WLRCR	Single Seat Low Back, Left	2.00	1.50	1.50	
CTL1301WR	Single Seat Low Back, Right	2.00	1.50	1.50	
CTL1301WRCL	Single Seat Low Back, Right	2.00	1.50	1.50	
CTL1302	Single Seat Mid Back	2.00	1.75		
CTL1302UL	Single Seat Mid Back, Left	2.00	1.75	1.50	
CTL1302UR	Single Seat Mid Back, Right	2.00	1.75	1.50	
CTL1302WL	Single Seat Mid Back, Left	2.00	1.75	1.50	
CTL1302WR	Single Seat Mid Back, Right	2.00	1.75	1.50	
CTL1303	Single Seat High Back	2.00	1.75		0.75
CTL1303UL	Single Seat High Back, Left	2.00	1.75	1.50	0.75
CTL1303UR	Single Seat High Back, Right	2.00	1.75	1.50	0.75
CTL1303WL	Single Seat High Back, Left	2.00	1.75	1.50	0.75
CTL1303WR	Single Seat High Back, Right	2.00	1.75	1.50	0.75
CTL1304	Single Seat High Back	2.00	1.75		0.75
CTL1304UL	Single Seat High Back, Left	2.00	1.75	1.50	0.75
CTL1304UR	Single Seat High Back, Right	2.00	1.75	1.50	0.75
CTL1304WL	Single Seat High Back, Left	2.00	1.75	1.50	0.75
CTL1304WR	Single Seat High Back, Right	2.00	1.75	1.50	0.75
CTL1305	Single Seat Privacy Back	2.00	1.75		1.25
CTL1305UL	Single Seat Privacy Back, Left	2.00	1.75	1.50	1.25
CTL1305UR	Single Seat Privacy Back, Right	2.00	1.75	1.50	1.25
CTL1305WL	Single Seat Privacy Back, Left	2.00	1.75	1.50	1.25
CTL1305WR	Single Seat Privacy Back, Right	2.00	1.75	1.50	1.25
CTL1306	Single Seat Privacy Back	2.00	1.75		1.25
CTL1306UL	Single Seat Privacy Back, Left	2.00	1.75	1.50	1.25
CTL1306UR	Single Seat Privacy Back, Right	2.00	1.75	1.50	1.25
CTL1306WL	Single Seat Privacy Back, Left	2.00	1.75	1.50	1.25
CTL1306WR	Single Seat Privacy Back, Right	2.00	1.75	1.50	1.25
CTL2201	Two Seat Low Back	4.00	3.00		
CTL2201U2	Two Seat Low Back	4.00	3.00	3.00	
CTL2201U2CC	Two Seat Low Back	4.00	3.00	3.00	
CTL2201W2	Two Seat Low Back	4.00	3.00	3.00	
CTL2201W2CC	Two Seat Low Back	4.00	3.00	3.00	
CTL2301	Two Seat Low Back	4.00	3.00		
CTL2301U2	Two Seat Low Back	4.00	3.00	3.00	
CTL2301U2CC	Two Seat Low Back	4.00	3.00	3.00	
CTL2301UL	Two Seat Low Back, Left	4.00	3.00	1.50	
CTL2301UR	Two Seat Low Back, Right	4.00	3.00	1.50	
CTL2301W2	Two Seat Low Back	4.00	3.00	3.00	
CTL2301W2CC	Two Seat Low Back	4.00	3.00	3.00	
CTL2301WL	Two Seat Low Back, Left	4.00	3.00	1.50	
CTL2301WR	Two Seat Low Back, Right	4.00	3.00	1.50	
CTL2302	Two Seat Mid Back	4.00	3.50		
CTL2302UL	Two Seat Mid Back, Left	4.00	3.50	1.50	
CTL2302UR	Two Seat Mid Back, Right	4.00	3.50	1.50	
CTL2302WL	Two Seat Mid Back, Left	4.00	3.50	1.50	
CTL2302WR	Two Seat Mid Back, Right	4.00	3.50	1.50	
CTL2303	Two Seat High Back	4.00	3.50		1.50
CTL2303UL	Two Seat High Back, Left	4.00	3.50	1.50	1.50
CTL2303UR	Two Seat High Back, Right	4.00	3.50	1.50	1.50
CTL2303WL	Two Seat High Back, Left	4.00	3.50	1.50	1.50
CTL2303WR	Two Seat High Back, Right	4.00	3.50	1.50	1.50
CTL2304	Two Seat High Back	4.00	3.50		1.50
CTL2304UL	Two Seat High Back, Left	4.00	3.50	1.50	1.50
CTL2304UR	Two Seat High Back, Right	4.00	3.50	1.50	1.50
CTL2304WL	Two Seat High Back, Left	4.00	3.50	1.50	1.50
CTL2304WR	Two Seat High Back, Right	4.00	3.50	1.50	1.50
CTL2305	Two Seat Privacy Back	4.00	3.50		2.50

Model	Description	Seat Only COM Ydg	Back Only COM Ydg	Arm Only COM Ydg	Headrest Only COM Ydg
CTL2305UL	Two Seat Privacy Back, Left	4.00	3.50	1.50	2.50
CTL2305UR	Two Seat Privacy Back, Right	4.00	3.50	1.50	2.50
CTL2305WL	Two Seat Privacy Back, Left	4.00	3.50	1.50	2.50
CTL2305WR	Two Seat Privacy Back, Right	4.00	3.50	1.50	2.50
CTL2306	Two Seat Privacy Back	4.00	3.50		2.50
CTL2306UL	Two Seat Privacy Back, Left	4.00	3.50	1.50	2.50
CTL2306UR	Two Seat Privacy Back, Right	4.00	3.50	1.50	2.50
CTL2306WL	Two Seat Privacy Back, Left	4.00	3.50	1.50	2.50
CTL2306WR	Two Seat Privacy Back, Right	4.00	3.50	1.50	2.50
CTL3201	Three Seat Low Back	6.00	4.50		
CTL3201U2	Three Seat Low Back	6.00	4.50	3.00	
CTL3201W2	Three Seat Low Back	6.00	4.50	3.00	
CTL3301	Three Seat Low Back	6.00	4.50		
CTL3302	Three Seat Mid Back	6.00	5.25		
CTL3303	Three Seat High Back	6.00	5.25		2.25
CTL3304	Three Seat High Back	6.00	5.25		2.25
CTL3305	Three Seat Privacy Back	6.00	5.25		3.75
CTL3306	Three Seat Privacy Back	6.00	5.25		3.75
CTL4201	Four Seat Low Back	8.00	6.00		
CTL4201U2	Four Seat Low Back	8.00	6.00	3.00	
CTL4201W2	Four Seat Low Back	8.00	6.00	3.00	
CTO32121	90° Curved Seat Low Back	2.25	1.50		
CTO32122	90° Curved Seat Mid Back	2.25	2.00		
CTO32123	90° Curved Seat High Back	2.25	2.00		0.75
CTO32125	90° Curved Seat Privacy Back	2.25	2.00		1.00
CTO32301	45° Curved Seat Low Back	1.50	1.50		
CTO32302	45° Curved Seat Mid Back	1.50	1.75		
CTO32303	45° Curved Seat High Back	1.50	1.75		0.75
CTO32304	45° Curved Seat High Back	1.50	1.75		0.75
CTO32305	45° Curved Seat Privacy Back	1.50	1.75		1.00
CTO32306	45° Curved Seat Privacy Back	1.50	1.75		1.00
CTO32451	45° Curved Seat Low Back	2.00	2.00		
CTO32452	45° Curved Seat Mid Back	2.00	2.50		
CTO32453	45° Curved Seat High Back	2.00	2.50		1.00
CTO32454	45° Curved Seat High Back	2.00	2.50		1.00
CTO32455	45° Curved Seat Privacy Back	2.00	2.50		1.50
CTO32456	45° Curved Seat Privacy Back	2.00	2.50		1.50

Typicals:
CT001

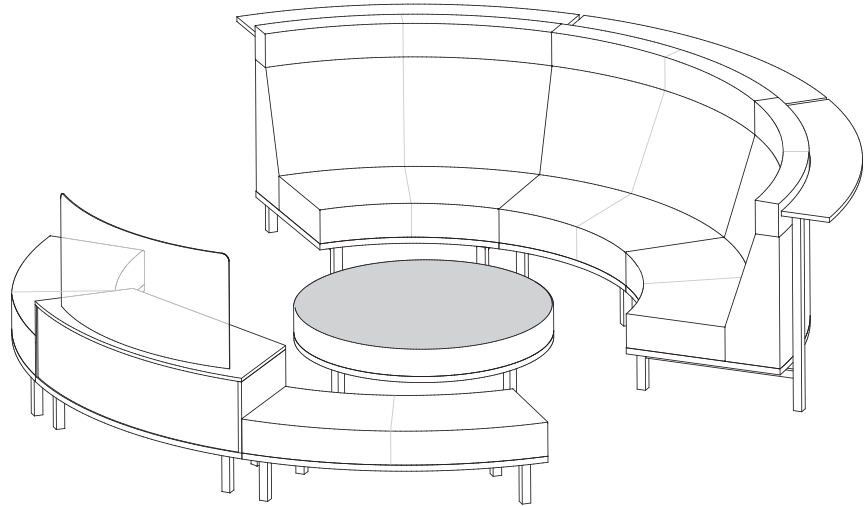
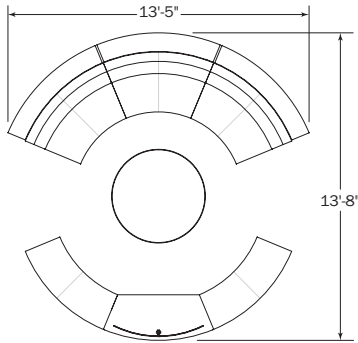

Total List \$18,064

Models

- (3) CTI32454
- (1) CTD42U
- (2) CTI20420
- (1) CT2060MCAS

CT002

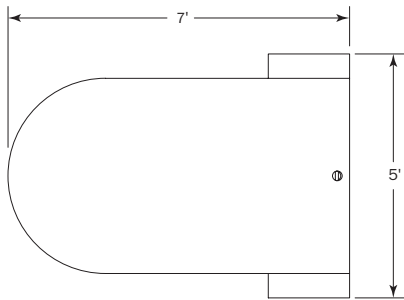

Total List \$6,865

Models

- (1) CT6084MACB
- (4) PX800L

Typicals:
CT003

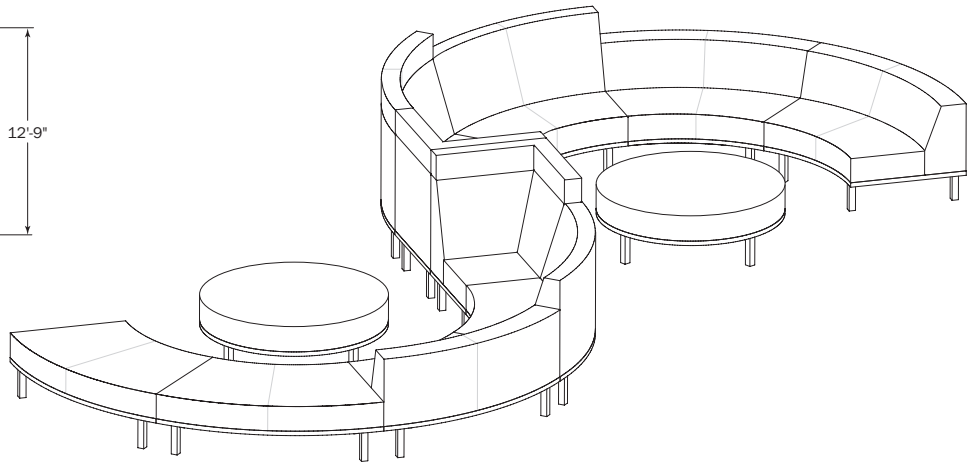
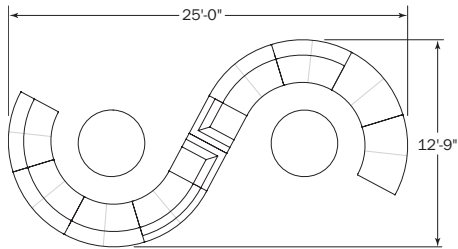

Models

Total List \$24,619

- | | |
|--------------|---------------|
| (2) CTI32450 | (2) CTC20S3UR |
| (3) CTI32451 | (1) CTI32453 |
| (2) CTI32452 | (2) CTD500 |

CT004

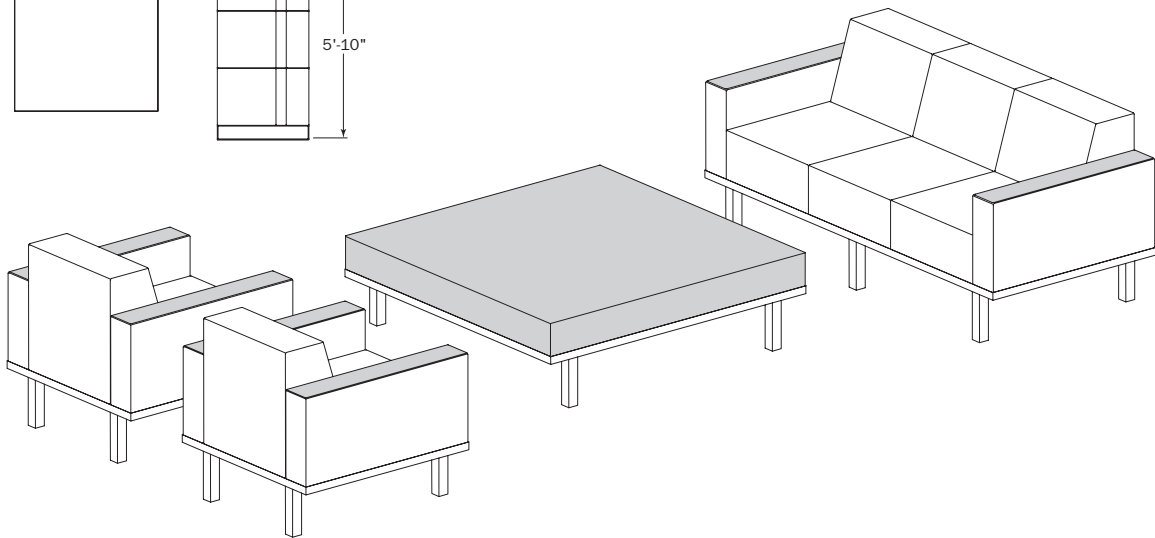
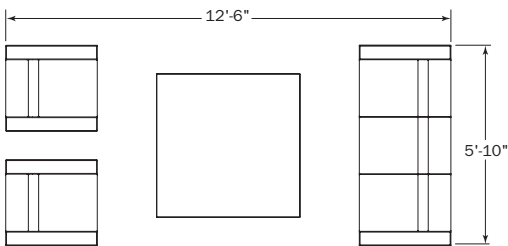

Models

Total List \$9,846

- | |
|---------------|
| (1) CTL3201W2 |
| (1) CTS50W |
| (2) CTL1201W2 |

LOUNGE

Typicals:
CT005

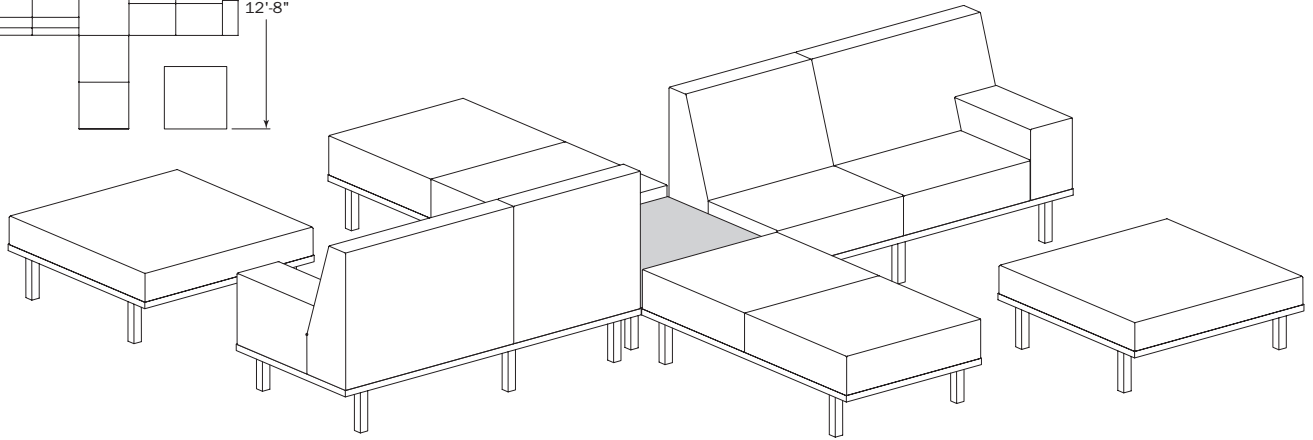
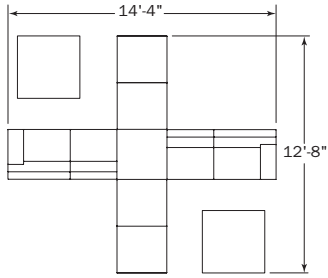

Total List \$13,410

Models

- (2) CTL2302UL
- (2) CTL2300
- (1) CTS32WS
- (2) CTS400

CT006

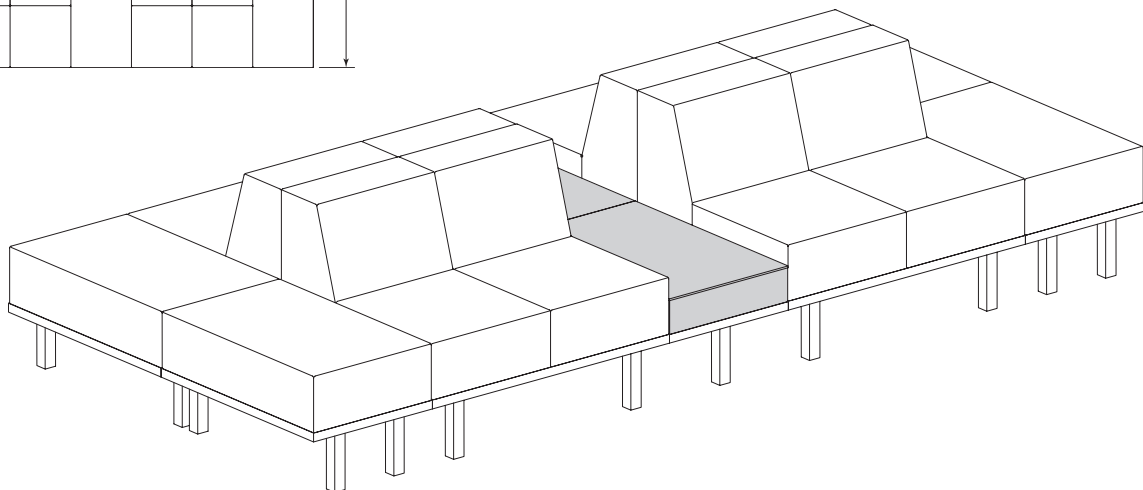
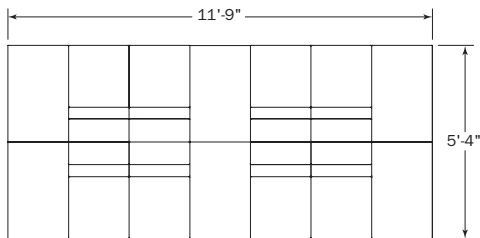

Total List \$14,440

Models

- (4) CTL1200
- (4) CTL2201
- (2) CTR3220CC

Typicals:
CT007

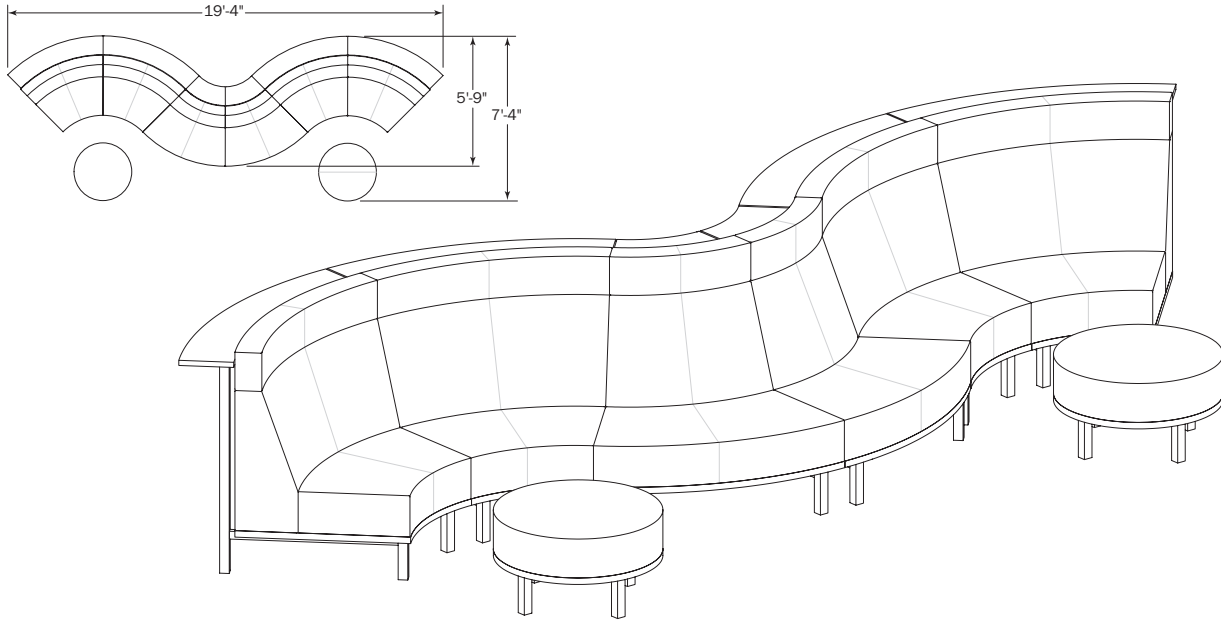

Models

Total List \$22,692

- (4) CTI32304
- (2) CT032304
- (2) CTD300

CT008

LOUNGE

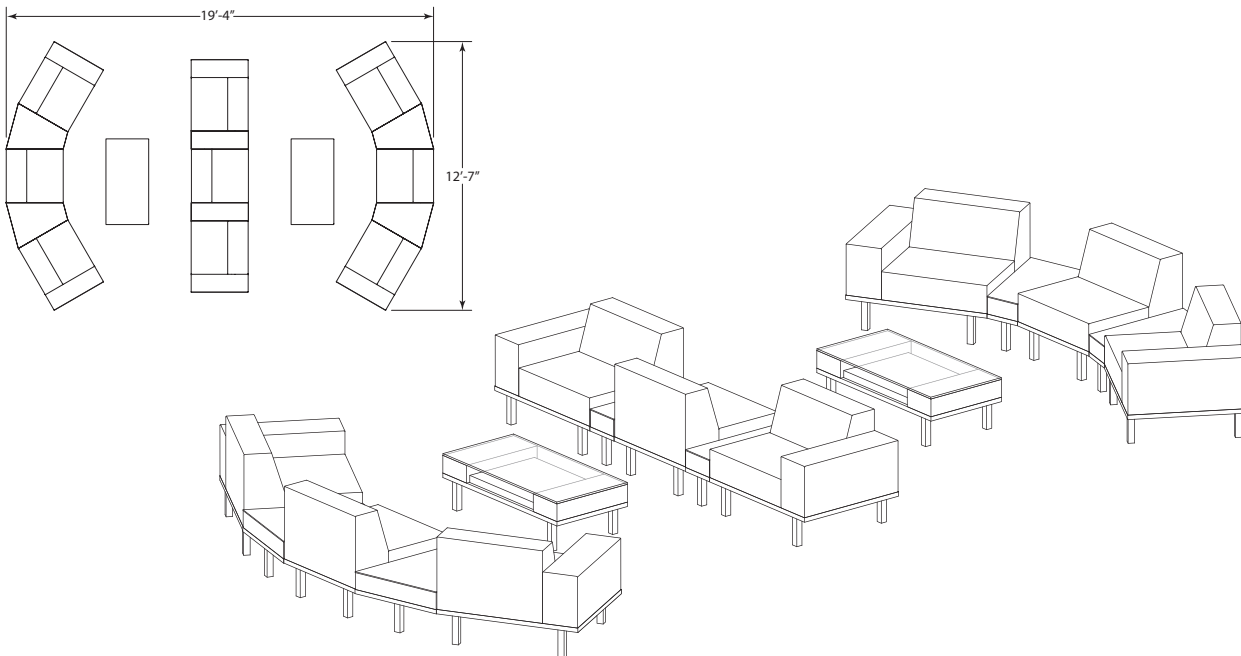

Models

Total List \$22,491

- | | |
|---------------|---------------|
| (3) CTL1301UL | (4) CTW30C |
| (3) CTL1301UR | (2) CTR3210CC |
| (3) CTL1301 | (2) CT2448-15 |

**Typicals:
CT009**

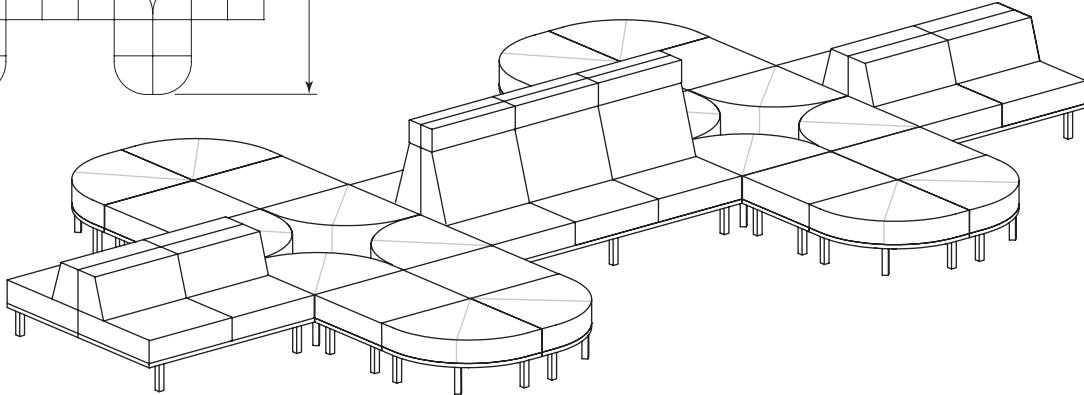
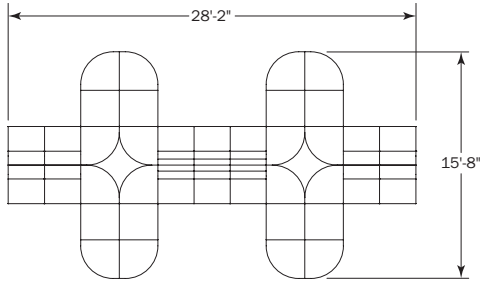

Total List \$44,856

Models

- (8) CTL1301
- (16) CTW900
- (8) CTS320
- (6) CTL1303

Curved Unit Typical:
CT010

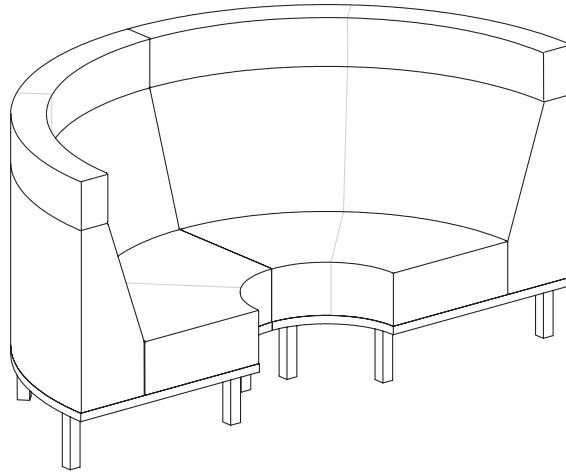
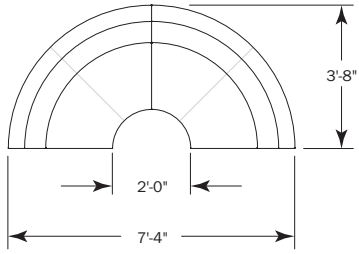

Total List \$4,698

Models
(2) CTI32123

CT011

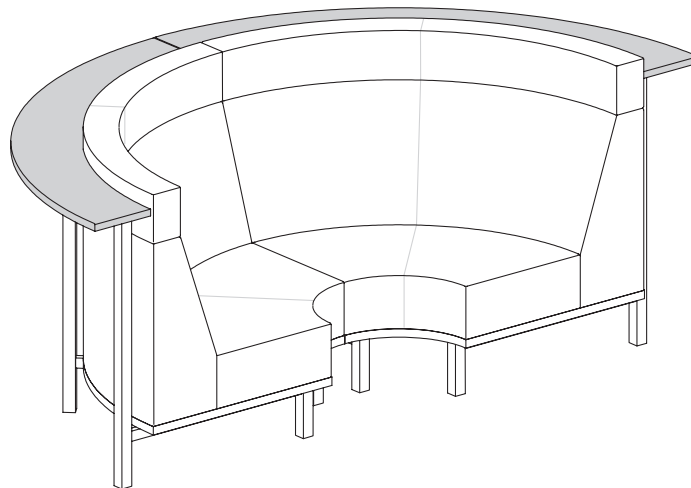
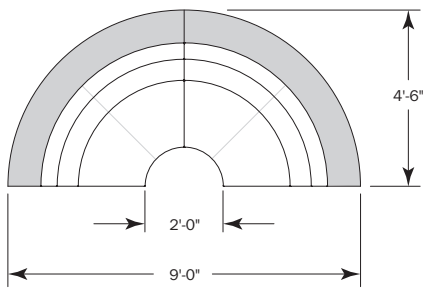

Total List \$6,550

Models
(2) CTI32124

LOUNGE

Curved Unit Typical:
CT012

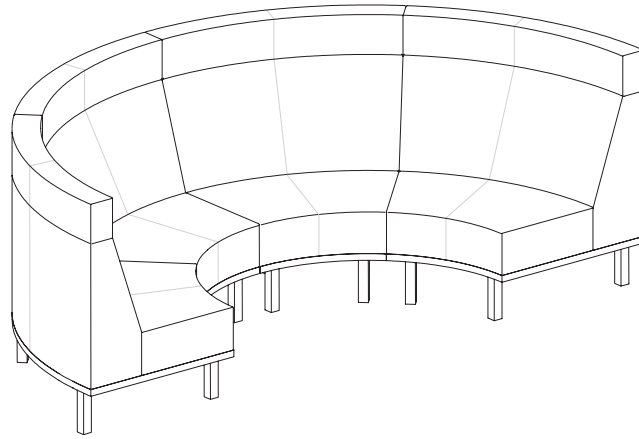
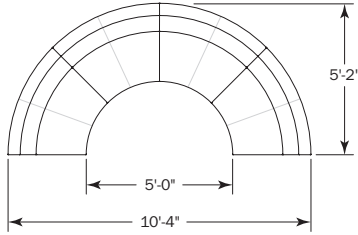

Total List \$9,156

Models
(4) CTI32303

CT013

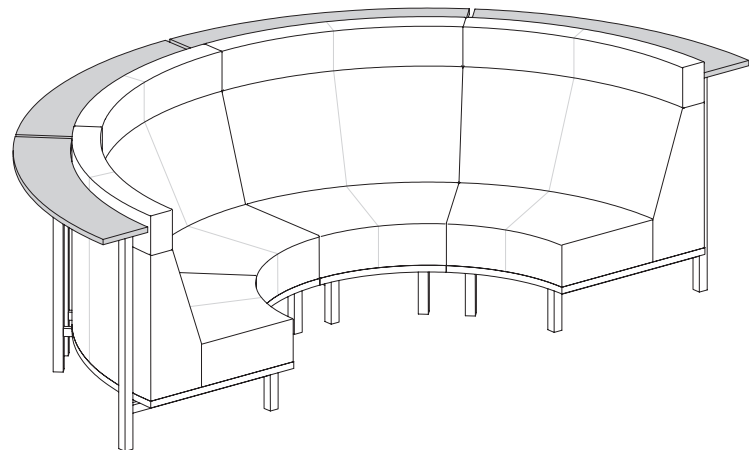
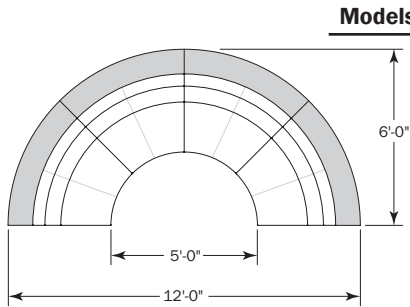

Total List \$12,976

Models
(4) CTI32304

Curved Unit Typical: CT014

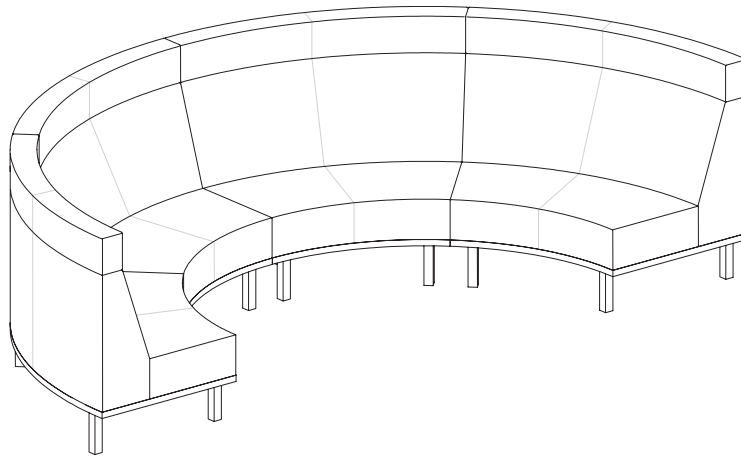
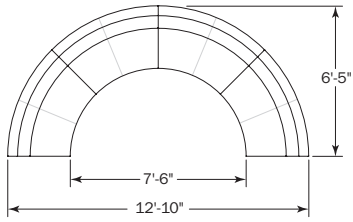

Models

Total List \$9,316

(4) CTI32453

CT015

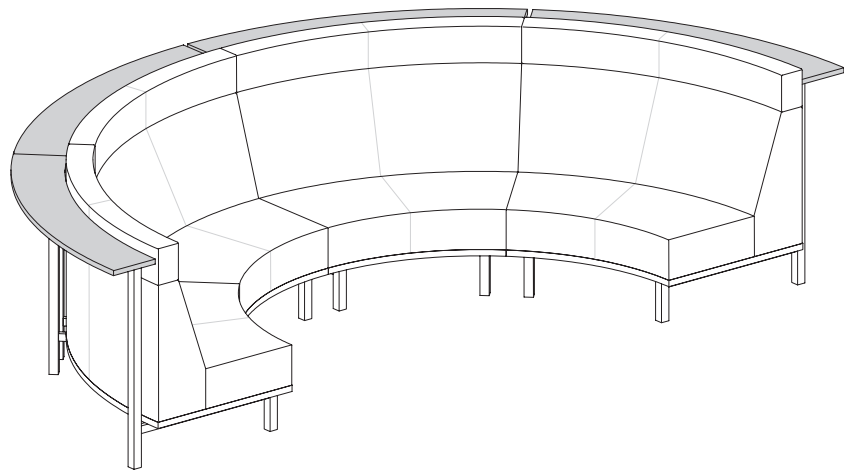
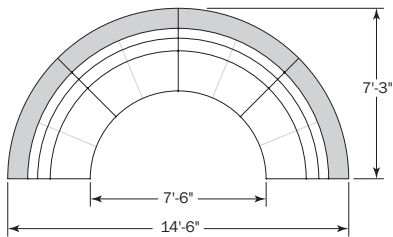

Models

Total List \$14,996

(4) CTI32454

LOUNGE

Curved Unit Typical:
CT016

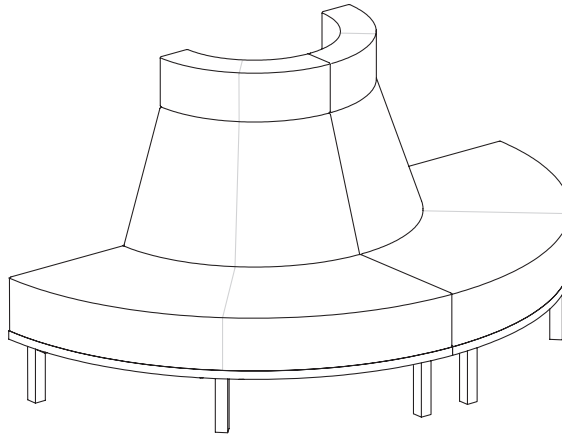
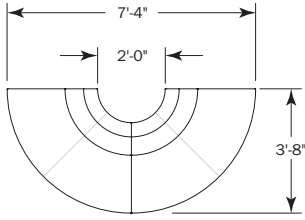

Total List \$4,540

Models
(2) CT032123

CT017

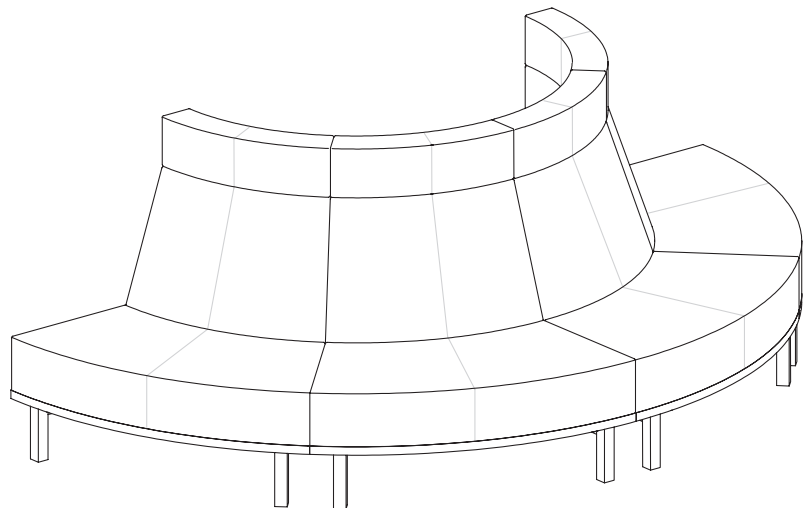
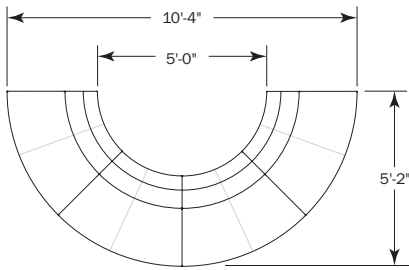

Total List \$9,000

Models
(4) CT032303

LOUNGE

Curved Unit Typical: CT018

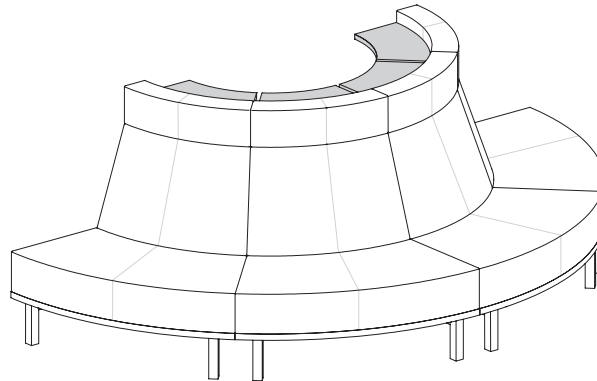
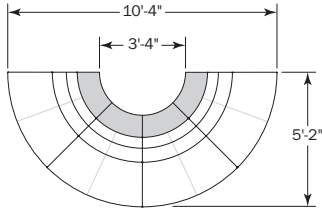

Total List \$12,452

Models

(4) CT032304

LOUNGE

CT019

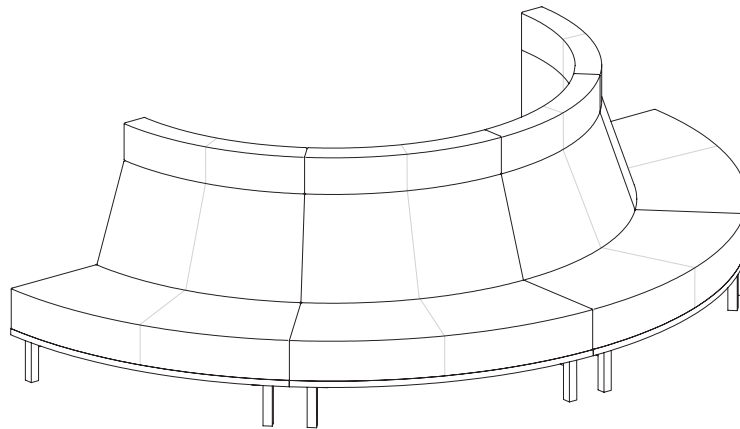
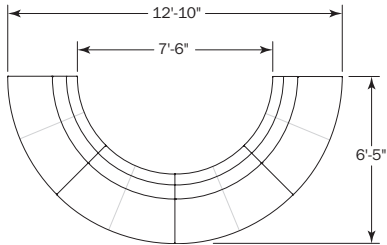

Total List \$9,156

Models

(4) CT032453

**Curved Unit Typical:
CT020**

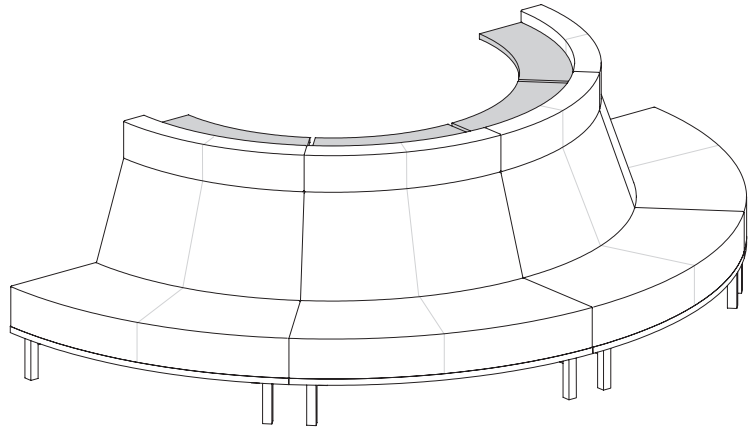
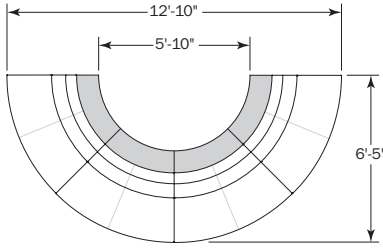

Total List \$12,692

Models

(4) CT032454

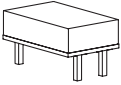
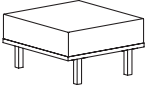
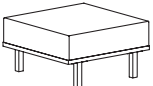
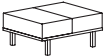
Description	① Model	Specifications				List Price Per Grade	
Single Seat Bench 	CTL1200 · 20" seat width · recommended for modular configuration only	Dimensions		D	W	H	COM \$1,040 A \$1,078 B \$1,122 COL/C \$1,200 D \$1,298 E \$1,397 F \$1,551 G \$1,716 H \$1,892 I \$2,167 J \$2,496 L1 \$1,969 L2 \$2,199
		Overall	32	20	18	Seat	
		Upholstery		Shipping			
		COM Ydg	2 ¼	Ctn Wt	55		F \$1,551
		COL Sq Ft	52	Cu Ft	7		G \$1,716
							H \$1,892
							I \$2,167
							J \$2,496
							L1 \$1,969
							L2 \$2,199
Single Seat Bench 	CTL1300 · 30" seat width	Dimensions		D	W	H	COM \$1,052 A \$1,090 B \$1,133 COL/C \$1,211 D \$1,310 E \$1,409 F \$1,563 G \$1,728 H \$1,903 I \$2,178 J \$2,508 L1 \$1,981 L2 \$2,211
		Overall	32	30	18	Seat	
		Upholstery		Shipping			
		COM Ydg	2 ¼	Ctn Wt	58		F \$1,563
		COL Sq Ft	52	Cu Ft	10		G \$1,728
							H \$1,903
							I \$2,178
							J \$2,508
							L1 \$1,981
							L2 \$2,211
Single Seat Bench 	CTS320 · 32" seat width · attaches to lounge, bench or other linking units to form a 90° shaped connection	Dimensions		D	W	H	COM \$1,221 A \$1,262 B \$1,306 COL/C \$1,382 D \$1,481 E \$1,581 F \$1,734 G \$1,899 H \$2,075 I \$2,350 J \$2,680 L1 \$2,152 L2 \$2,383
		Overall	32	32	18	Seat	
		Upholstery		Shipping			
		COM Ydg	2 ¼	Ctn Wt	73		F \$1,734
		COL Sq Ft	52	Cu Ft	10		G \$1,899
							H \$2,075
							I \$2,350
							J \$2,680
							L1 \$2,152
							L2 \$2,383
Two Seat Bench 	CTL2200 · 20" individual seat width	Dimensions		D	W	H	COM \$1,869 A \$1,942 B \$2,030 COL/C \$2,184 D \$2,382 E \$2,580 F \$2,888 G \$3,218 H \$3,569 I \$4,120 J \$4,779 L1 \$3,724 L2 \$4,185
		Overall	32	40	18	Seat	
		Upholstery		Shipping			
		COM Ydg	4 ½	Ctn Wt	79		F \$2,888
		COL Sq Ft	104	Cu Ft	13		G \$3,218
							H \$3,569
							I \$4,120
							J \$4,779
							L1 \$3,724
							L2 \$4,185

LOUNGE

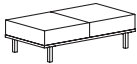
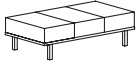
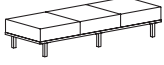
Description	Model	Specifications			List Price Per Grade	
Two Seat Bench 	CTL2300 · 30" individual seat width	Dimensions	D	W	H	COM \$1,889
		Overall	32	60	18	A \$1,963
		Seat	32	60	18	B \$2,050
		Upholstery	Shipping			COL/C \$2,204
		COM Ydg	4 ½	Ctn Wt	100	D \$2,402
		COL Sq Ft	104	Cu Ft	19	E \$2,600
						F \$2,908
						G \$3,238
						H \$3,589
						I \$4,140
				J \$4,799		
				L1 \$3,744		
				L2 \$4,205		
Three Seat Bench 	CTL3200 · 20" individual seat width	Dimensions	D	W	H	COM \$2,698
		Overall	32	60	18	A \$2,805
		Seat	32	60	18	B \$2,937
		Upholstery	Shipping			COL/C \$3,168
		COM Ydg	6 ¾	Ctn Wt	113	D \$3,464
		COL Sq Ft	156	Cu Ft	19	E \$3,762
						F \$4,224
						G \$4,718
						H \$5,246
						I \$6,071
				J \$7,061		
				L1 \$5,477		
				L2 \$6,169		
Three Seat Bench 	CTL3300 · 30" individual seat width	Dimensions	D	W	H	COM \$2,728
		Overall	32	90	18	A \$2,837
		Seat	32	90	18	B \$2,968
		Upholstery	Shipping			COL/C \$3,199
		COM Ydg	6 ¾	Ctn Wt	158	D \$3,496
		COL Sq Ft	156	Cu Ft	28	E \$3,793
						F \$4,254
						G \$4,750
						H \$5,277
						I \$6,102
				J \$7,091		
				L1 \$5,508		
				L2 \$6,200		

To Order, Specify:

- 1 Model Number
- 2 Wood Species - Cherry (CH1), Maple (MA1) or Walnut (WA1)
- 3 Wood Finish
- 4 Fabric Selection - vendor, pattern and color
- 5 Metal Leg Color - Black Sandtex (BSX), Soft Nickel (SNK) or Stardust Silver (STS)
- 6 Product Options

3 Wood Finish Options:

- Cherry**
- | | |
|--------------|-------------|
| AUT Autumn | EAR Earthy |
| BRL Barley | LGC Legacy |
| BRG Brighton | PRL Praline |
| BBN Bourbon | SAF Saffron |
| CLA Classic | |
- Maple**
- | | |
|------------------|----------------|
| ALE Ale | FLX Flax ▲ |
| BUT Butterscotch | VEN Venetian ▲ |
| CIN Cinnamon | |
- Walnut**
- | | |
|---------------|-------------|
| AUB Auburn | TOF Toffee |
| ESP Espresso | TRF Truffle |
| MCH Mocha | SIE Sienna |
| NTO Night owl | |



Specifications

- Wood species - Cherry, Maple or Walnut.
- Seat has synthetic sheet webbing with cross strap reinforcement, 4 ¼" high density polyurethane foam.
- Plywood construction with locking tenons, glue and screws.
- Linking bracket included.
- Metal legs are 16 gauge steel tube with metal leveling glides.

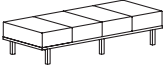
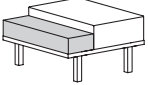
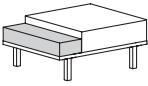
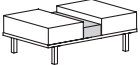
4 See a selection of graded in fabric manufacturers and patterns on pages 12-20. Contact Customer Service for additional fabric options.

Description	① Model	Specifications	List Price Per Grade																																						
Four Seat Bench 	CTL4200 · 20" individual seat width	<table border="1"> <thead> <tr> <th>Dimensions</th> <th>D</th> <th>W</th> <th>H</th> </tr> </thead> <tbody> <tr> <td>Overall</td> <td>32</td> <td>80</td> <td>18</td> </tr> <tr> <td>Seat</td> <td>32</td> <td>80</td> <td>18</td> </tr> </tbody> </table>	Dimensions	D	W	H	Overall	32	80	18	Seat	32	80	18	<table border="1"> <thead> <tr> <th>COM</th> <th>\$3,320</th> </tr> </thead> <tbody> <tr><td>A</td><td>\$3,458</td></tr> <tr><td>B</td><td>\$3,635</td></tr> <tr><td>COL/C</td><td>\$3,942</td></tr> <tr><td>D</td><td>\$4,338</td></tr> <tr><td>E</td><td>\$4,734</td></tr> <tr><td>F</td><td>\$5,349</td></tr> <tr><td>G</td><td>\$6,009</td></tr> <tr><td>H</td><td>\$6,713</td></tr> <tr><td>I</td><td>\$7,812</td></tr> <tr><td>J</td><td>\$9,131</td></tr> <tr><td>L1</td><td>\$7,021</td></tr> <tr><td>L2</td><td>\$7,944</td></tr> </tbody> </table>	COM	\$3,320	A	\$3,458	B	\$3,635	COL/C	\$3,942	D	\$4,338	E	\$4,734	F	\$5,349	G	\$6,009	H	\$6,713	I	\$7,812	J	\$9,131	L1	\$7,021	L2	\$7,944
		Dimensions	D	W	H																																				
Overall	32	80	18																																						
Seat	32	80	18																																						
COM	\$3,320																																								
A	\$3,458																																								
B	\$3,635																																								
COL/C	\$3,942																																								
D	\$4,338																																								
E	\$4,734																																								
F	\$5,349																																								
G	\$6,009																																								
H	\$6,713																																								
I	\$7,812																																								
J	\$9,131																																								
L1	\$7,021																																								
L2	\$7,944																																								
<table border="1"> <thead> <tr> <th>Upholstery</th> <th colspan="2">Shipping</th> </tr> </thead> <tbody> <tr> <td>COM Ydg</td> <td>9</td> <td>Ctn Wt 146</td> </tr> <tr> <td>COL Sq Ft</td> <td>207</td> <td>Cu Ft 25</td> </tr> </tbody> </table>	Upholstery	Shipping		COM Ydg	9	Ctn Wt 146	COL Sq Ft	207	Cu Ft 25																																
Upholstery	Shipping																																								
COM Ydg	9	Ctn Wt 146																																							
COL Sq Ft	207	Cu Ft 25																																							
Single Seat Bench with End Table 	CTL1200CR CTL1200CL · 20" seat width · 10" table width	<table border="1"> <thead> <tr> <th>Dimensions</th> <th>D</th> <th>W</th> <th>H</th> </tr> </thead> <tbody> <tr> <td>Overall</td> <td>32</td> <td>30</td> <td>18</td> </tr> <tr> <td>Seat</td> <td>32</td> <td>20</td> <td>18</td> </tr> </tbody> </table>	Dimensions	D	W	H	Overall	32	30	18	Seat	32	20	18	<table border="1"> <thead> <tr> <th>COM</th> <th>\$1,250</th> </tr> </thead> <tbody> <tr><td>A</td><td>\$1,291</td></tr> <tr><td>B</td><td>\$1,335</td></tr> <tr><td>COL/C</td><td>\$1,413</td></tr> <tr><td>D</td><td>\$1,511</td></tr> <tr><td>E</td><td>\$1,610</td></tr> <tr><td>F</td><td>\$1,764</td></tr> <tr><td>G</td><td>\$1,929</td></tr> <tr><td>H</td><td>\$2,105</td></tr> <tr><td>I</td><td>\$2,380</td></tr> <tr><td>J</td><td>\$2,709</td></tr> <tr><td>L1</td><td>\$2,182</td></tr> <tr><td>L2</td><td>\$2,412</td></tr> </tbody> </table>	COM	\$1,250	A	\$1,291	B	\$1,335	COL/C	\$1,413	D	\$1,511	E	\$1,610	F	\$1,764	G	\$1,929	H	\$2,105	I	\$2,380	J	\$2,709	L1	\$2,182	L2	\$2,412
		Dimensions	D	W	H																																				
Overall	32	30	18																																						
Seat	32	20	18																																						
COM	\$1,250																																								
A	\$1,291																																								
B	\$1,335																																								
COL/C	\$1,413																																								
D	\$1,511																																								
E	\$1,610																																								
F	\$1,764																																								
G	\$1,929																																								
H	\$2,105																																								
I	\$2,380																																								
J	\$2,709																																								
L1	\$2,182																																								
L2	\$2,412																																								
<table border="1"> <thead> <tr> <th>Upholstery</th> <th colspan="2">Shipping</th> </tr> </thead> <tbody> <tr> <td>COM Ydg</td> <td>2 ¼</td> <td>Ctn Wt 75</td> </tr> <tr> <td>COL Sq Ft</td> <td>52</td> <td>Cu Ft 10</td> </tr> </tbody> </table>	Upholstery	Shipping		COM Ydg	2 ¼	Ctn Wt 75	COL Sq Ft	52	Cu Ft 10																																
Upholstery	Shipping																																								
COM Ydg	2 ¼	Ctn Wt 75																																							
COL Sq Ft	52	Cu Ft 10																																							
Single Seat Bench with End Table 	CTL1300CR CTL1300CL · 30" seat width · 10" table width	<table border="1"> <thead> <tr> <th>Dimensions</th> <th>D</th> <th>W</th> <th>H</th> </tr> </thead> <tbody> <tr> <td>Overall</td> <td>32</td> <td>40</td> <td>18</td> </tr> <tr> <td>Seat</td> <td>32</td> <td>30</td> <td>18</td> </tr> </tbody> </table>	Dimensions	D	W	H	Overall	32	40	18	Seat	32	30	18	<table border="1"> <thead> <tr> <th>COM</th> <th>\$1,320</th> </tr> </thead> <tbody> <tr><td>A</td><td>\$1,362</td></tr> <tr><td>B</td><td>\$1,406</td></tr> <tr><td>COL/C</td><td>\$1,484</td></tr> <tr><td>D</td><td>\$1,583</td></tr> <tr><td>E</td><td>\$1,682</td></tr> <tr><td>F</td><td>\$1,836</td></tr> <tr><td>G</td><td>\$2,001</td></tr> <tr><td>H</td><td>\$2,176</td></tr> <tr><td>I</td><td>\$2,451</td></tr> <tr><td>J</td><td>\$2,781</td></tr> <tr><td>L1</td><td>\$2,254</td></tr> <tr><td>L2</td><td>\$2,484</td></tr> </tbody> </table>	COM	\$1,320	A	\$1,362	B	\$1,406	COL/C	\$1,484	D	\$1,583	E	\$1,682	F	\$1,836	G	\$2,001	H	\$2,176	I	\$2,451	J	\$2,781	L1	\$2,254	L2	\$2,484
		Dimensions	D	W	H																																				
Overall	32	40	18																																						
Seat	32	30	18																																						
COM	\$1,320																																								
A	\$1,362																																								
B	\$1,406																																								
COL/C	\$1,484																																								
D	\$1,583																																								
E	\$1,682																																								
F	\$1,836																																								
G	\$2,001																																								
H	\$2,176																																								
I	\$2,451																																								
J	\$2,781																																								
L1	\$2,254																																								
L2	\$2,484																																								
<table border="1"> <thead> <tr> <th>Upholstery</th> <th colspan="2">Shipping</th> </tr> </thead> <tbody> <tr> <td>COM Ydg</td> <td>2 ¼</td> <td>Ctn Wt 85</td> </tr> <tr> <td>COL Sq Ft</td> <td>52</td> <td>Cu Ft 13</td> </tr> </tbody> </table>	Upholstery	Shipping		COM Ydg	2 ¼	Ctn Wt 85	COL Sq Ft	52	Cu Ft 13																																
Upholstery	Shipping																																								
COM Ydg	2 ¼	Ctn Wt 85																																							
COL Sq Ft	52	Cu Ft 13																																							
Two Seat Bench with Center Console 	CTL2200CC · 20" individual seat width · 10" wide center console	<table border="1"> <thead> <tr> <th>Dimensions</th> <th>D</th> <th>W</th> <th>H</th> </tr> </thead> <tbody> <tr> <td>Overall</td> <td>32</td> <td>50</td> <td>18</td> </tr> <tr> <td>Seat</td> <td>32</td> <td>40</td> <td>18</td> </tr> </tbody> </table>	Dimensions	D	W	H	Overall	32	50	18	Seat	32	40	18	<table border="1"> <thead> <tr> <th>COM</th> <th>\$1,993</th> </tr> </thead> <tbody> <tr><td>A</td><td>\$2,068</td></tr> <tr><td>B</td><td>\$2,156</td></tr> <tr><td>COL/C</td><td>\$2,309</td></tr> <tr><td>D</td><td>\$2,508</td></tr> <tr><td>E</td><td>\$2,705</td></tr> <tr><td>F</td><td>\$3,014</td></tr> <tr><td>G</td><td>\$3,344</td></tr> <tr><td>H</td><td>\$3,695</td></tr> <tr><td>I</td><td>\$4,245</td></tr> <tr><td>J</td><td>\$4,905</td></tr> <tr><td>L1</td><td>\$3,849</td></tr> <tr><td>L2</td><td>\$4,311</td></tr> </tbody> </table>	COM	\$1,993	A	\$2,068	B	\$2,156	COL/C	\$2,309	D	\$2,508	E	\$2,705	F	\$3,014	G	\$3,344	H	\$3,695	I	\$4,245	J	\$4,905	L1	\$3,849	L2	\$4,311
		Dimensions	D	W	H																																				
Overall	32	50	18																																						
Seat	32	40	18																																						
COM	\$1,993																																								
A	\$2,068																																								
B	\$2,156																																								
COL/C	\$2,309																																								
D	\$2,508																																								
E	\$2,705																																								
F	\$3,014																																								
G	\$3,344																																								
H	\$3,695																																								
I	\$4,245																																								
J	\$4,905																																								
L1	\$3,849																																								
L2	\$4,311																																								
<table border="1"> <thead> <tr> <th>Upholstery</th> <th colspan="2">Shipping</th> </tr> </thead> <tbody> <tr> <td>COM Ydg</td> <td>4 ½</td> <td>Ctn Wt 96</td> </tr> <tr> <td>COL Sq Ft</td> <td>104</td> <td>Cu Ft 16</td> </tr> </tbody> </table>	Upholstery	Shipping		COM Ydg	4 ½	Ctn Wt 96	COL Sq Ft	104	Cu Ft 16																																
Upholstery	Shipping																																								
COM Ydg	4 ½	Ctn Wt 96																																							
COL Sq Ft	104	Cu Ft 16																																							

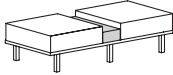
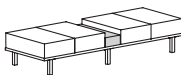
LOUNGE

Description	Model	Specifications				List Price Per Grade	
		Dimensions	D	W	H	COM	
Two Seat Bench with Center Console 	CTL2300CC · 30" individual seat width · 10" wide center console	Overall	32	70	18	COM	\$2,139
		Seat	32	60	18	A	\$2,216
						B	\$2,304
						COL/C	\$2,457
						D	\$2,656
						E	\$2,853
						F	\$3,162
						G	\$3,492
						H	\$3,843
						I	\$4,393
						J	\$5,053
						L1	\$3,997
						L2	\$4,459
Four Seat Bench with Center Console 	CTL4200CC · 20" individual seat width · 10" wide center console	Overall	32	90	18	COM	\$3,484
		Seat	32	80	18	A	\$3,625
						B	\$3,801
						COL/C	\$4,109
						D	\$4,505
						E	\$4,901
						F	\$5,516
						G	\$6,177
						H	\$6,880
						I	\$7,979
						J	\$9,299
						L1	\$7,188
						L2	\$8,111
90° Curved Bench 	CTI32120 · 12" inside radius · 44" outside radius	Overall	32		18	COM	\$1,609
		Seat	32		18	A	\$1,658
						B	\$1,707
						COL/C	\$1,793
						D	\$1,903
						E	\$2,012
						F	\$2,183
						G	\$2,367
						H	\$2,562
						I	\$2,868
						J	\$3,234
						L1	\$2,648
						L2	\$2,904

LOUNGE

To Order, Specify:

- 1 Model Number
- 2 Wood Species - Cherry (CH1), Maple (MA1) or Walnut (WA1)
- 3 Wood Finish
- 4 Fabric Selection - vendor, pattern and color
- 5 Metal Leg Color - Black Sandtex (BSX), Soft Nickel (SNK) or Stardust Silver (STS)
- 6 Optional Power Center - Flush Mount (EC22) - Black (B) or White (W); \$504 list each, see page 201 for location availability
- 7 Optional Drink Holders (DH) - add \$168 list
- 8 Optional Coordinating Wood Grain Laminate Available on Table Top - no upcharge. Finishes with an asterisk have a coordinating laminate available.
- 9 Product Options

3 Wood Finish Options:

Cherry			
AUT	Autumn*	EAR	Earthy
BRL	Barley*	LGC	Legacy*
BBN	Bourbon*	PRL	Praline*
BRG	Brighton*	SAF	Saffron*
CLA	Classic*		
Maple			
ALE	Ale*	FLX	Flax ▲
BUT	Butterscotch	VEN	Venetian* ▲
CIN	Cinnamon*		
Walnut			
AUB	Auburn*	TOF	Toffee*
ESP	Espresso	TRF	Truffle*
MCH	Mocha*	SIE	Sienna*
NTO	Night owl*		

Specifications

- Wood species - Cherry, Maple or Walnut.
- Seat has synthetic sheet webbing with cross strap reinforcement, 4 ¼" high density polyurethane foam.
- Plywood construction with locking tenons, glue and screws.
- Linking bracket included.
- Metal legs are 16 gauge steel tube with metal leveling glides.

4 See a selection of graded in fabric manufacturers and patterns on pages 12-20. Contact Customer Service for additional fabric options.

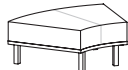
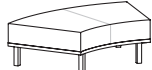
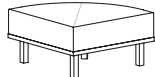
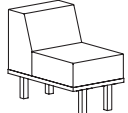
Description	① Model	Specifications				List Price Per Grade
		Dimensions	D	W	H	
45° Curved Bench 	CTI32300 · 30" inside radius · 66" outside radius	Overall	32		18	COM \$1,609
		Seat	32		18	A \$1,653
		Upholstery		Shipping		B \$1,692
		COM Ydg	2	Ctn Wt	62	COL/C \$1,761
		COL Sq Ft	46	Cu Ft	18	D \$1,848
						E \$1,937
						F \$2,073
						G \$2,220
						H \$2,377
						I \$2,621
						J \$2,914
						L1 \$2,445
						L2 \$2,650
45° Curved Bench 	CTI32450 · 45" inside radius · 77" outside radius	Overall	32		18	COM \$1,609
		Seat	32		18	A \$1,658
		Upholstery		Shipping		B \$1,707
		COM Ydg	2 ½	Ctn Wt	65	COL/C \$1,793
		COL Sq Ft	58	Cu Ft	22	D \$1,903
						E \$2,012
						F \$2,183
						G \$2,367
						H \$2,562
						I \$2,868
						J \$3,234
						L1 \$2,648
						L2 \$2,904
Quarter Round Bench 	CTW900 · 32" seat width · fully upholstered	Overall	32		18	COM \$1,068
		Seat	32		18	A \$1,104
		Upholstery		Shipping		B \$1,144
		COM Ydg	2	Ctn Wt	58	COL/C \$1,212
		COL Sq Ft	46	Cu Ft	11	D \$1,300
						E \$1,388
						F \$1,525
						G \$1,671
						H \$1,827
						I \$2,072
						J \$2,365
						L1 \$1,896
						L2 \$2,102
Single Seat Low Back 	CTL1201 · armless · 20" seat width · COM based on single fabric · multiple fabrics, see pages 204-206 for yardage requirements	Overall	32	20	30 ½	COM \$1,078
		Seat	20	20	18	A \$1,129
		Upholstery		Shipping		B \$1,197
		COM Ydg	3 ½	Ctn Wt	66	COL/C \$1,317
		COL Sq Ft	81	Cu Ft	11	D \$1,470
						E \$1,625
						F \$1,864
						G \$2,120
						H \$2,394
						I \$2,822
						J \$3,335
						L1 \$2,514
						L2 \$2,873

LOUNGE

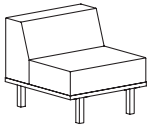
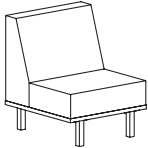
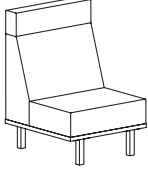
Description	1 Model	Specifications				List Price Per Grade				
 <p>Single Seat Low Back</p>	<p>CTL1301</p> <ul style="list-style-type: none"> armless 30" seat width COM based on single fabric multiple fabrics, see pages 204-206 for yardage requirements 	Dimensions				<p>COM \$1,173</p> <p>A \$1,226</p> <p>B \$1,294</p> <p>COL/C \$1,414</p> <p>D \$1,568</p> <p>E \$1,721</p> <p>F \$1,961</p> <p>G \$2,218</p> <p>H \$2,491</p> <p>I \$2,919</p> <p>J \$3,432</p> <p>L1 \$2,611</p> <p>L2 \$2,970</p>				
		Overall		D	W		H			
		Seat		20	30		18			
		Upholstery		Shipping						
		COM Ydg	3 1/2	Ctn Wt	77					
		COL Sq Ft	81	Cu Ft	16					
		 <p>Single Seat Mid Back</p>	<p>CTL1302</p> <ul style="list-style-type: none"> armless 30" seat width COM based on single fabric multiple fabrics, see pages 204-206 for yardage requirements 	Dimensions				<p>COM \$1,305</p> <p>A \$1,361</p> <p>B \$1,435</p> <p>COL/C \$1,563</p> <p>D \$1,728</p> <p>E \$1,893</p> <p>F \$2,150</p> <p>G \$2,424</p> <p>H \$2,718</p> <p>I \$3,176</p> <p>J \$3,725</p> <p>L1 \$2,846</p> <p>L2 \$3,230</p>		
				Overall			D		W	H
				Seat			20		30	18
				Upholstery			Shipping			
COM Ydg	3 3/4			Ctn Wt	82					
COL Sq Ft	87			Cu Ft	21					
 <p>Single Seat High Back</p>	<p>CTL1303</p> <ul style="list-style-type: none"> armless 30" seat width 7" high headrest COM based on single fabric multiple fabrics, see pages 204-206 for yardage requirements 			Dimensions					<p>COM \$1,436</p> <p>A \$1,502</p> <p>B \$1,590</p> <p>COL/C \$1,743</p> <p>D \$1,942</p> <p>E \$2,139</p> <p>F \$2,448</p> <p>G \$2,778</p> <p>H \$3,129</p> <p>I \$3,679</p> <p>J \$4,339</p> <p>L1 \$3,283</p> <p>L2 \$3,745</p>	
				Overall		D	W			H
				Seat		20	30			18
				Upholstery		Shipping				
		COM Ydg	4 1/2	Ctn Wt	90					
		COL Sq Ft	104	Cu Ft	25					

LOUNGE

To Order, Specify:

- 1 Model Number
- 2 Wood Species - Cherry (CH1), Maple (MA1) or Walnut (WA1)
- 3 Wood Finish
- 4 Fabric Selection - vendor, pattern and color
 - A. Seat
 - B. Back
- 5 Metal Leg Color - Black Sandtex (BSX), Soft Nickel (SNK) or Stardust Silver (STS)

3 Wood Finish Options:

- Cherry**
- AUT Autumn
 - BRL Barley
 - BBN Bourbon
 - BRG Brighton
 - CLA Classic
- Maple**
- ALE Ale
 - BUT Butterscotch
 - CIN Cinnamon
- Walnut**
- AUB Auburn
 - ESP Espresso
 - MCH Mocha
 - NTO Night owl
- EAR Earthy
 - LGC Legacy
 - PRL Praline
 - SAF Saffron
- FLX Flax ▲
 - VEN Venetian ▲
- TOF Toffee
 - TRF Truffle
 - SIE Sienna



Specifications

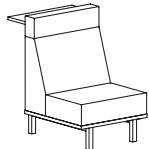
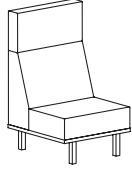
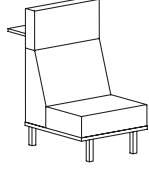
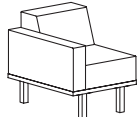
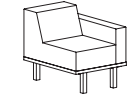

- Wood species - Cherry, Maple or Walnut.
- Seat has synthetic sheet webbing with cross strap reinforcement, 4 1/4" high density polyurethane foam.
- Back has high density polyurethane foam.
- Plywood construction with locking tenons, glue and screws.
- Linking bracket included.
- Metal legs are 16 gauge steel tube with metal leveling glides.

4 See a selection of graded in fabric manufacturers and patterns on pages 12-20. Contact Customer Service for additional fabric options.

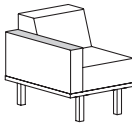
Description	① Model	Specifications	List Price Per Grade																
Single Seat High Back 	CTL1304 · armless · 30" seat width · 7" high headrest · 41 ¾" high stand up surface · COM based on single fabric · multiple fabrics, see pages 204-206 for yardage requirements	<table border="1"> <thead> <tr> <th>Dimensions</th> <th>D</th> <th>W</th> <th>H</th> </tr> </thead> <tbody> <tr> <td>Overall</td> <td>42</td> <td>30</td> <td>44 ½</td> </tr> <tr> <td>Seat</td> <td>20</td> <td>30</td> <td>18</td> </tr> </tbody> </table>	Dimensions	D	W	H	Overall	42	30	44 ½	Seat	20	30	18	COM \$2,232 A \$2,309 B \$2,398 COL/C \$2,552 D \$2,749 E \$2,948 F \$3,255 G \$3,585 H \$3,937 I \$4,487 J \$5,147 L1 \$4,091 L2 \$4,552				
		Dimensions	D	W	H														
Overall	42	30	44 ½																
Seat	20	30	18																
<table border="1"> <thead> <tr> <th>Upholstery</th> <th colspan="3">Shipping</th> </tr> </thead> <tbody> <tr> <td>COM Ydg</td> <td>4 ½</td> <td>Ctn Wt</td> <td>125</td> </tr> <tr> <td>COL Sq Ft</td> <td>104</td> <td>Cu Ft</td> <td>34</td> </tr> </tbody> </table>	Upholstery	Shipping			COM Ydg	4 ½	Ctn Wt	125	COL Sq Ft	104	Cu Ft	34							
Upholstery	Shipping																		
COM Ydg	4 ½	Ctn Wt	125																
COL Sq Ft	104	Cu Ft	34																
Single Seat Privacy Back 	CTL1305 · armless · 30" seat width · 14" high headrest · COM based on single fabric · multiple fabrics, see pages 204-206 for yardage requirements	<table border="1"> <thead> <tr> <th>Dimensions</th> <th>D</th> <th>W</th> <th>H</th> </tr> </thead> <tbody> <tr> <td>Overall</td> <td>32</td> <td>30</td> <td>51 ½</td> </tr> <tr> <td>Seat</td> <td>20</td> <td>30</td> <td>18</td> </tr> </tbody> </table>	Dimensions	D	W	H	Overall	32	30	51 ½	Seat	20	30	18	COM \$1,567 A \$1,641 B \$1,738 COL/C \$1,909 D \$2,129 E \$2,348 F \$2,691 G \$3,057 H \$3,449 I \$4,059 J \$4,792 L1 \$3,619 L2 \$4,132				
		Dimensions	D	W	H														
Overall	32	30	51 ½																
Seat	20	30	18																
<table border="1"> <thead> <tr> <th>Upholstery</th> <th colspan="3">Shipping</th> </tr> </thead> <tbody> <tr> <td>COM Ydg</td> <td>5</td> <td>Ctn Wt</td> <td>93</td> </tr> <tr> <td>COL Sq Ft</td> <td>115</td> <td>Cu Ft</td> <td>29</td> </tr> </tbody> </table>	Upholstery	Shipping			COM Ydg	5	Ctn Wt	93	COL Sq Ft	115	Cu Ft	29							
Upholstery	Shipping																		
COM Ydg	5	Ctn Wt	93																
COL Sq Ft	115	Cu Ft	29																
Single Seat Privacy Back 	CTL1306 · armless · stand up surface · 30" seat width · 14" high headrest · 41 ¾" high stand up surface · COM based on single fabric · multiple fabrics, see pages 204-206 for yardage requirements	<table border="1"> <thead> <tr> <th>Dimensions</th> <th>D</th> <th>W</th> <th>H</th> </tr> </thead> <tbody> <tr> <td>Overall</td> <td>42</td> <td>30</td> <td>51 ½</td> </tr> <tr> <td>Seat</td> <td>20</td> <td>30</td> <td>18</td> </tr> </tbody> </table>	Dimensions	D	W	H	Overall	42	30	51 ½	Seat	20	30	18	COM \$2,363 A \$2,448 B \$2,546 COL/C \$2,717 D \$2,936 E \$3,157 F \$3,499 G \$3,866 H \$4,256 I \$4,867 J \$5,600 L1 \$4,427 L2 \$4,940				
		Dimensions	D	W	H														
Overall	42	30	51 ½																
Seat	20	30	18																
<table border="1"> <thead> <tr> <th>Upholstery</th> <th colspan="3">Shipping</th> </tr> </thead> <tbody> <tr> <td>COM Ydg</td> <td>5</td> <td>Ctn Wt</td> <td>128</td> </tr> <tr> <td>COL Sq Ft</td> <td>115</td> <td>Cu Ft</td> <td>39</td> </tr> </tbody> </table>	Upholstery	Shipping			COM Ydg	5	Ctn Wt	128	COL Sq Ft	115	Cu Ft	39							
Upholstery	Shipping																		
COM Ydg	5	Ctn Wt	128																
COL Sq Ft	115	Cu Ft	39																
Single Seat Low Back  CTL1201UR right  CTL1201UL left	CTL1201UR CTL1201UL · upholstered arm · 5" arm width · 20" seat width · COM based on single fabric · multiple fabrics, see pages 204-206 for yardage requirements	<table border="1"> <thead> <tr> <th>Dimensions</th> <th>D</th> <th>W</th> <th>H</th> </tr> </thead> <tbody> <tr> <td>Overall</td> <td>32</td> <td>25</td> <td>30 ½</td> </tr> <tr> <td>Seat</td> <td>20</td> <td>20</td> <td>18</td> </tr> <tr> <td>Arm</td> <td></td> <td>5</td> <td>24 ½</td> </tr> </tbody> </table>	Dimensions	D	W	H	Overall	32	25	30 ½	Seat	20	20	18	Arm		5	24 ½	COM \$1,501 A \$1,573 B \$1,671 COL/C \$1,842 D \$2,062 E \$2,281 F \$2,623 G \$2,990 H \$3,381 I \$3,992 J \$4,724 L1 \$3,552 L2 \$4,065
		Dimensions	D	W	H														
Overall	32	25	30 ½																
Seat	20	20	18																
Arm		5	24 ½																
<table border="1"> <thead> <tr> <th>Upholstery</th> <th colspan="3">Shipping</th> </tr> </thead> <tbody> <tr> <td>COM Ydg</td> <td>5</td> <td>Ctn Wt</td> <td>72</td> </tr> <tr> <td>COL Sq Ft</td> <td>115</td> <td>Cu Ft</td> <td>14</td> </tr> </tbody> </table>	Upholstery	Shipping			COM Ydg	5	Ctn Wt	72	COL Sq Ft	115	Cu Ft	14							
Upholstery	Shipping																		
COM Ydg	5	Ctn Wt	72																
COL Sq Ft	115	Cu Ft	14																

LOUNGE

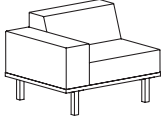
Description	Model	Specifications			List Price Per Grade		
		Dimensions	D	W	H	COM	
Single Seat Low Back  CTL1201WR right  CTL1201WL left	CTL1201WR CTL1201WL <ul style="list-style-type: none"> • wood cap arm • 5" arm width • 20" seat width • COM based on single fabric • multiple fabrics, see pages 204-206 for yardage requirements 	Overall	32	25	30½	A	\$1,631
		Seat	20	20	18	COL/C	\$1,973
		Arm	5		25	D	\$2,194
		Upholstery		Shipping		E	\$2,413
		COM Ydg	5	Ctn Wt	77	F	\$2,756
		COL Sq Ft	115	Cu Ft	14	G	\$3,122
						H	\$3,513
						I	\$4,124
						J	\$4,857
						L1	\$3,684
						L2	\$4,197

Description	Model	Specifications			List Price Per Grade		
		Dimensions	D	W	H	COM	
Single Seat Low Back  CTL1301UR right  CTL1301UL left	CTL1301UR CTL1301UL <ul style="list-style-type: none"> • upholstered arm • 10" arm width • 30" seat width • COM based on single fabric • multiple fabrics, see pages 204-206 for yardage requirements 	Overall	32	40	30½	A	\$1,628
		Seat	20	30	18	COL/C	\$1,970
		Arm	10		24½	D	\$2,191
		Upholstery		Shipping		E	\$2,410
		COM Ydg	5	Ctn Wt	104	F	\$2,753
		COL Sq Ft	115	Cu Ft	21	G	\$3,119
						H	\$3,510
						I	\$4,121
						J	\$4,854
						L1	\$3,681
						L2	\$4,194

LOUNGE

To Order, Specify:

- 1 Model Number
- 2 Wood Species - Cherry (CH1), Maple (MA1) or Walnut (WA1)
- 3 Wood Finish
- 4 Laminate Color Selection (Stand up Surface)
- 5 Fabric Selection - vendor, pattern and color
 - A. Seat
 - B. Back
 - C. Arm
 - D. Headrest
- 6 Metal Leg Color - Black Sandtex (BSX), Soft Nickel (SNK) or Stardust Silver (STS)
- 7 Optional Power Center - Flush Mount (EC22) - Black (B) or White (W); \$504 list each, see page 201 for location availability
- 8 Optional Drink Holder (DH) - add \$84 list each
- 9 Optional Tablet Arm - indicate left (TBL) or right arm (TBR); add \$476 list
- ▲ 10 Optional Coordinating Wood Grain Laminate Available on Wood Cap Arm - no upcharge. Finishes with an asterisk have a coordinating laminate available.
- 11 Product Options

3 Wood Finish Options:

Cherry			
AUT	Autumn*	EAR	Earthy
BRL	Barley*	LGC	Legacy*
BBN	Bourbon*	PRL	Praline*
BRG	Brighton*	SAF	Saffron*
CLA	Classic*		
Maple			
ALE	Ale*	FLX	Flax ▲
BUT	Butterscotch	VEN	Venetian* ▲
CIN	Cinnamon*		
Walnut			
AUB	Auburn*	TOF	Toffee*
ESP	Espresso	TRF	Truffle*
MCH	Mocha*	SIE	Sienna*
NTO	Night owl*		



4 Laminate Color Selection (Stand Up Surface)

ALB	Alabaster	SHD	Shadow
BBL	Bridal Blanco	SLG	Slate Grey
DWH	Designer White	TAU	Taupe
DOV	Dove Grey		

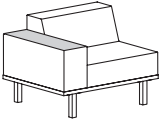
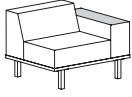
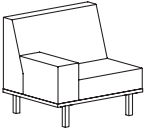

- 5 See a selection of graded in fabric manufacturers and patterns on pages 12-20. Contact Customer Service for additional fabric options.

Specifications

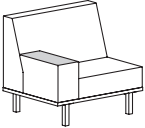
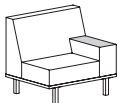
- Wood species - Cherry, Maple or Walnut.
- Seat has synthetic sheet webbing with cross strap reinforcement, 4 ¼" high density polyurethane foam.
- Back has high density polyurethane foam.
- Arms have ¾" thick top and ¼" thick side high density polyurethane foam.
- Plywood construction with locking tenons, glue and screws.
- Linking bracket included.
- Metal legs are 16 gauge steel tube with metal leveling glides.
- ¾" thick 10" deep laminate stand up surface with coordinating 3mm PVC edge supported by steel columns, 42" surface height.

Description	① Model	Specifications	List Price Per Grade																												
Single Seat Low Back  CTL1301WR right  CTL1301WL left	CTL1301WR CTL1301WL <ul style="list-style-type: none"> · wood cap arm · 10" arm width · 30" seat width · COM based on single fabric · multiple fabrics, see pages 204-206 for yardage requirements 	<table border="1"> <thead> <tr> <th>Dimensions</th> <th>D</th> <th>W</th> <th>H</th> </tr> </thead> <tbody> <tr> <td>Overall</td> <td>32</td> <td>40</td> <td>30½</td> </tr> <tr> <td>Seat</td> <td>20</td> <td>30</td> <td>18</td> </tr> <tr> <td>Arm</td> <td></td> <td>10</td> <td>25</td> </tr> </tbody> </table>	Dimensions	D	W	H	Overall	32	40	30½	Seat	20	30	18	Arm		10	25	<table border="1"> <thead> <tr> <th colspan="2">Upholstery</th> <th colspan="2">Shipping</th> </tr> </thead> <tbody> <tr> <td>COM Ydg</td> <td>5</td> <td>Ctn Wt</td> <td>109</td> </tr> <tr> <td>COL Sq Ft</td> <td>115</td> <td>Cu Ft</td> <td>21</td> </tr> </tbody> </table>	Upholstery		Shipping		COM Ydg	5	Ctn Wt	109	COL Sq Ft	115	Cu Ft	21
		Dimensions	D	W	H																										
Overall	32	40	30½																												
Seat	20	30	18																												
Arm		10	25																												
Upholstery		Shipping																													
COM Ydg	5	Ctn Wt	109																												
COL Sq Ft	115	Cu Ft	21																												
			<table border="1"> <tbody> <tr><td>COM</td><td>\$1,758</td></tr> <tr><td>A</td><td>\$1,834</td></tr> <tr><td>B</td><td>\$1,931</td></tr> <tr><td>COL/C</td><td>\$2,103</td></tr> <tr><td>D</td><td>\$2,323</td></tr> <tr><td>E</td><td>\$2,543</td></tr> <tr><td>F</td><td>\$2,885</td></tr> <tr><td>G</td><td>\$3,251</td></tr> <tr><td>H</td><td>\$3,642</td></tr> <tr><td>I</td><td>\$4,253</td></tr> <tr><td>J</td><td>\$4,986</td></tr> <tr><td>L1</td><td>\$3,813</td></tr> <tr><td>L2</td><td>\$4,326</td></tr> </tbody> </table>	COM	\$1,758	A	\$1,834	B	\$1,931	COL/C	\$2,103	D	\$2,323	E	\$2,543	F	\$2,885	G	\$3,251	H	\$3,642	I	\$4,253	J	\$4,986	L1	\$3,813	L2	\$4,326		
COM	\$1,758																														
A	\$1,834																														
B	\$1,931																														
COL/C	\$2,103																														
D	\$2,323																														
E	\$2,543																														
F	\$2,885																														
G	\$3,251																														
H	\$3,642																														
I	\$4,253																														
J	\$4,986																														
L1	\$3,813																														
L2	\$4,326																														
Single Seat Mid Back  CTL1302UR right  CTL1302UL left	CTL1302UR CTL1302UL <ul style="list-style-type: none"> · upholstered arm · 10" arm width · 30" seat width · COM based on single fabric · multiple fabrics, see pages 204-206 for yardage requirements 	<table border="1"> <thead> <tr> <th>Dimensions</th> <th>D</th> <th>W</th> <th>H</th> </tr> </thead> <tbody> <tr> <td>Overall</td> <td>32</td> <td>40</td> <td>37½</td> </tr> <tr> <td>Seat</td> <td>20</td> <td>30</td> <td>18</td> </tr> <tr> <td>Arm</td> <td></td> <td>10</td> <td>24½</td> </tr> </tbody> </table>	Dimensions	D	W	H	Overall	32	40	37½	Seat	20	30	18	Arm		10	24½	<table border="1"> <thead> <tr> <th colspan="2">Upholstery</th> <th colspan="2">Shipping</th> </tr> </thead> <tbody> <tr> <td>COM Ydg</td> <td>5¼</td> <td>Ctn Wt</td> <td>104</td> </tr> <tr> <td>COL Sq Ft</td> <td>121</td> <td>Cu Ft</td> <td>27</td> </tr> </tbody> </table>	Upholstery		Shipping		COM Ydg	5¼	Ctn Wt	104	COL Sq Ft	121	Cu Ft	27
		Dimensions	D	W	H																										
Overall	32	40	37½																												
Seat	20	30	18																												
Arm		10	24½																												
Upholstery		Shipping																													
COM Ydg	5¼	Ctn Wt	104																												
COL Sq Ft	121	Cu Ft	27																												
			<table border="1"> <tbody> <tr><td>COM</td><td>\$1,759</td></tr> <tr><td>A</td><td>\$1,838</td></tr> <tr><td>B</td><td>\$1,940</td></tr> <tr><td>COL/C</td><td>\$2,119</td></tr> <tr><td>D</td><td>\$2,350</td></tr> <tr><td>E</td><td>\$2,581</td></tr> <tr><td>F</td><td>\$2,940</td></tr> <tr><td>G</td><td>\$3,326</td></tr> <tr><td>H</td><td>\$3,736</td></tr> <tr><td>I</td><td>\$4,378</td></tr> <tr><td>J</td><td>\$5,148</td></tr> <tr><td>L1</td><td>\$3,916</td></tr> <tr><td>L2</td><td>\$4,455</td></tr> </tbody> </table>	COM	\$1,759	A	\$1,838	B	\$1,940	COL/C	\$2,119	D	\$2,350	E	\$2,581	F	\$2,940	G	\$3,326	H	\$3,736	I	\$4,378	J	\$5,148	L1	\$3,916	L2	\$4,455		
COM	\$1,759																														
A	\$1,838																														
B	\$1,940																														
COL/C	\$2,119																														
D	\$2,350																														
E	\$2,581																														
F	\$2,940																														
G	\$3,326																														
H	\$3,736																														
I	\$4,378																														
J	\$5,148																														
L1	\$3,916																														
L2	\$4,455																														
Single Seat Mid Back  CTL1302WR right  CTL1302WL left	CTL1302WR CTL1302WL <ul style="list-style-type: none"> · wood cap arm · 10" arm width · 30" seat width · COM based on single fabric · multiple fabrics, see pages 204-206 for yardage requirements 	<table border="1"> <thead> <tr> <th>Dimensions</th> <th>D</th> <th>W</th> <th>H</th> </tr> </thead> <tbody> <tr> <td>Overall</td> <td>32</td> <td>40</td> <td>37½</td> </tr> <tr> <td>Seat</td> <td>20</td> <td>30</td> <td>18</td> </tr> <tr> <td>Arm</td> <td></td> <td>10</td> <td>25</td> </tr> </tbody> </table>	Dimensions	D	W	H	Overall	32	40	37½	Seat	20	30	18	Arm		10	25	<table border="1"> <thead> <tr> <th colspan="2">Upholstery</th> <th colspan="2">Shipping</th> </tr> </thead> <tbody> <tr> <td>COM Ydg</td> <td>5¼</td> <td>Ctn Wt</td> <td>109</td> </tr> <tr> <td>COL Sq Ft</td> <td>121</td> <td>Cu Ft</td> <td>27</td> </tr> </tbody> </table>	Upholstery		Shipping		COM Ydg	5¼	Ctn Wt	109	COL Sq Ft	121	Cu Ft	27
		Dimensions	D	W	H																										
Overall	32	40	37½																												
Seat	20	30	18																												
Arm		10	25																												
Upholstery		Shipping																													
COM Ydg	5¼	Ctn Wt	109																												
COL Sq Ft	121	Cu Ft	27																												
			<table border="1"> <tbody> <tr><td>COM</td><td>\$1,889</td></tr> <tr><td>A</td><td>\$1,970</td></tr> <tr><td>B</td><td>\$2,072</td></tr> <tr><td>COL/C</td><td>\$2,252</td></tr> <tr><td>D</td><td>\$2,483</td></tr> <tr><td>E</td><td>\$2,714</td></tr> <tr><td>F</td><td>\$3,073</td></tr> <tr><td>G</td><td>\$3,458</td></tr> <tr><td>H</td><td>\$3,869</td></tr> <tr><td>I</td><td>\$4,509</td></tr> <tr><td>J</td><td>\$5,279</td></tr> <tr><td>L1</td><td>\$4,048</td></tr> <tr><td>L2</td><td>\$4,586</td></tr> </tbody> </table>	COM	\$1,889	A	\$1,970	B	\$2,072	COL/C	\$2,252	D	\$2,483	E	\$2,714	F	\$3,073	G	\$3,458	H	\$3,869	I	\$4,509	J	\$5,279	L1	\$4,048	L2	\$4,586		
COM	\$1,889																														
A	\$1,970																														
B	\$2,072																														
COL/C	\$2,252																														
D	\$2,483																														
E	\$2,714																														
F	\$3,073																														
G	\$3,458																														
H	\$3,869																														
I	\$4,509																														
J	\$5,279																														
L1	\$4,048																														
L2	\$4,586																														

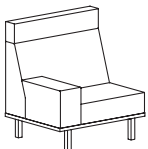
LOUNGE

Description	Model	Specifications			List Price Per Grade		
		Dimensions	D	W	H	COM	
Single Seat High Back	CTL1303UR	Overall	32	40	44 ½	COM	\$1,890
	CTL1303UL						A
 CTL1303UR right	<ul style="list-style-type: none"> · upholstered arm · 10" arm width · 30" seat width · 7" high headrest · COM based on single fabric · multiple fabrics, see pages 204-206 for yardage requirements 	Seat	20	30	18	COL/C	\$2,301
		Arm	10		24 ½		D
 CTL1303UL left		Upholstery		Shipping		E	\$2,828
		COM Ydg	6	Ctn Wt	120	F	\$3,239
		COL Sq Ft	138	Cu Ft	33	G	\$3,679
						H	\$4,148
						I	\$4,881
						J	\$5,761
						L1	\$4,353
						L2	\$4,968

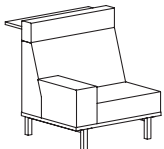
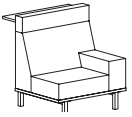
Description	Model	Specifications			List Price Per Grade		
		Dimensions	D	W	H	COM	
Single Seat High Back	CTL1304UR	Overall	42	40	44 ½	COM	\$2,698
	CTL1304UL						A
 CTL1304UR right	<ul style="list-style-type: none"> · upholstered arm · 10" arm width · 30" seat width · 7" high headrest · 41 ¾" high stand up surface · COM based on single fabric · multiple fabrics, see pages 204-206 for yardage requirements 	Seat	20	30	18	COL/C	\$3,120
		Arm	10		24 ½		D
 CTL1304UL left		Upholstery		Shipping		E	\$3,648
		COM Ydg	6	Ctn Wt	158	F	\$4,059
		COL Sq Ft	138	Cu Ft	43	G	\$4,499
						H	\$4,967
						I	\$5,701
						J	\$6,580
						L1	\$5,173
						L2	\$5,788

To Order, Specify:

- Model Number
- Wood Species - Cherry (CH1), Maple (MA1) or Walnut (WA1)
- Wood Finish
- Laminate Color Selection (Stand up Surface)
- Fabric Selection - vendor, pattern and color
 - Seat
 - Back
 - Arm
 - Headrest
- Metal Leg Color - Black Sandtex (BSX), Soft Nickel (SNK) or Stardust Silver (STS)
- Optional Power Center - Flush Mount (EC22) - Black (B) or White (W); \$504 list each, see page 201 for location availability
- Optional Drink Holder (DH) - add \$84 list each
- Optional Tablet Arm - indicate left (TBL) or right arm (TBR); add \$476 list
- Optional Coordinating Wood Grain Laminate Available on Wood Cap Arm - no upcharge. Finishes with an asterisk have a coordinating laminate available.
- Product Options

Wood Finish Options:

Cherry			
AUT	Autumn*	EAR	Earthy
BRL	Barley*	LGC	Legacy*
BBN	Bourbon*	PRL	Praline*
BRG	Brighton*	SAF	Saffron*
CLA	Classic*		
Maple			
ALE	Ale*	FLX	Flax▲
BUT	Butterscotch	VEN	Venetian*▲
CIN	Cinnamon*		
Walnut			
AUB	Auburn*	TOF	Toffee*
ESP	Espresso	TRF	Truffle*
MCH	Mocha*	SIE	Sienna*
NTO	Night owl		





Laminate Color Selection (Stand up Surface)

ALB	Alabaster	SHD	Shadow
BBL	Bridal Blanco	SLG	Slate Grey
DWH	Designer White	TAU	Taupe
DOV	Dove Grey		

- See a selection of graded in fabric manufacturers and patterns on pages 12-20. Contact Customer Service for additional fabric options.

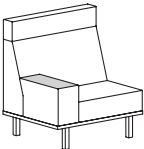

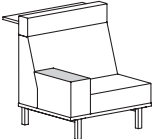
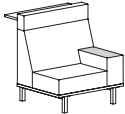
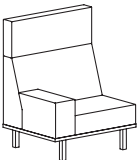
Specifications

- Wood species - Cherry, Maple or Walnut.
- Seat has synthetic sheet webbing with cross strap reinforcement, 4 ¼" high density polyurethane foam.
- Back has high density polyurethane foam.
- Arms have ¾" thick top and ¼" thick side high density polyurethane foam.
- Plywood construction with locking tenons, glue and screws.
- Linking bracket included.
- Metal legs are 16 gauge steel tube with metal leveling glides.
- ¾" thick 10" deep laminate stand up surface with coordinating 3mm PVC edge supported by steel columns, 42" surface height.

Description	① Model	Specifications	List Price Per Grade																																										
Single Seat High Back	CTL1303WR CTL1303WL <ul style="list-style-type: none"> · wood cap arm · 10" arm width · 30" seat width · 7" high headrest · COM based on single fabric · multiple fabrics, see pages 204-206 for yardage requirements 	<table border="1"> <thead> <tr> <th>Dimensions</th> <th>D</th> <th>W</th> <th>H</th> </tr> </thead> <tbody> <tr> <td>Overall</td> <td>32</td> <td>40</td> <td>44 ½</td> </tr> <tr> <td>Seat</td> <td>20</td> <td>30</td> <td>18</td> </tr> <tr> <td>Arm</td> <td></td> <td>10</td> <td>25</td> </tr> </tbody> </table>	Dimensions	D	W	H	Overall	32	40	44 ½	Seat	20	30	18	Arm		10	25	<table border="1"> <tbody> <tr> <td>COM</td> <td>\$2,021</td> </tr> <tr> <td>A</td> <td>\$2,110</td> </tr> <tr> <td>B</td> <td>\$2,228</td> </tr> <tr> <td>COL/C</td> <td>\$2,433</td> </tr> <tr> <td>D</td> <td>\$2,697</td> </tr> <tr> <td>E</td> <td>\$2,960</td> </tr> <tr> <td>F</td> <td>\$3,371</td> </tr> <tr> <td>G</td> <td>\$3,811</td> </tr> <tr> <td>H</td> <td>\$4,280</td> </tr> <tr> <td>I</td> <td>\$5,013</td> </tr> <tr> <td>J</td> <td>\$5,893</td> </tr> <tr> <td>L1</td> <td>\$4,485</td> </tr> <tr> <td>L2</td> <td>\$5,100</td> </tr> </tbody> </table>	COM	\$2,021	A	\$2,110	B	\$2,228	COL/C	\$2,433	D	\$2,697	E	\$2,960	F	\$3,371	G	\$3,811	H	\$4,280	I	\$5,013	J	\$5,893	L1	\$4,485	L2	\$5,100
		Dimensions	D	W	H																																								
Overall	32	40	44 ½																																										
Seat	20	30	18																																										
Arm		10	25																																										
COM	\$2,021																																												
A	\$2,110																																												
B	\$2,228																																												
COL/C	\$2,433																																												
D	\$2,697																																												
E	\$2,960																																												
F	\$3,371																																												
G	\$3,811																																												
H	\$4,280																																												
I	\$5,013																																												
J	\$5,893																																												
L1	\$4,485																																												
L2	\$5,100																																												
 CTL1303WR right  CTL1303WL left		<table border="1"> <thead> <tr> <th>Upholstery</th> <th colspan="2">Shipping</th> </tr> </thead> <tbody> <tr> <td>COM Ydg</td> <td>6</td> <td>Ctn Wt 125</td> </tr> <tr> <td>COL Sq Ft</td> <td>138</td> <td>Cu Ft 33</td> </tr> </tbody> </table>	Upholstery	Shipping		COM Ydg	6	Ctn Wt 125	COL Sq Ft	138	Cu Ft 33																																		
Upholstery	Shipping																																												
COM Ydg	6	Ctn Wt 125																																											
COL Sq Ft	138	Cu Ft 33																																											
Single Seat High Back	CTL1304WR CTL1304WL <ul style="list-style-type: none"> · wood cap arm · 10" arm width · 30" seat width · 7" high headrest · 41 ¾" high stand up surface · COM based on single fabric · multiple fabrics, see pages 204-206 for yardage requirements 	<table border="1"> <thead> <tr> <th>Dimensions</th> <th>D</th> <th>W</th> <th>H</th> </tr> </thead> <tbody> <tr> <td>Overall</td> <td>42</td> <td>40</td> <td>44 ½</td> </tr> <tr> <td>Seat</td> <td>20</td> <td>30</td> <td>18</td> </tr> <tr> <td>Arm</td> <td></td> <td>10</td> <td>25</td> </tr> </tbody> </table>	Dimensions	D	W	H	Overall	42	40	44 ½	Seat	20	30	18	Arm		10	25	<table border="1"> <tbody> <tr> <td>COM</td> <td>\$2,828</td> </tr> <tr> <td>A</td> <td>\$2,930</td> </tr> <tr> <td>B</td> <td>\$3,048</td> </tr> <tr> <td>COL/C</td> <td>\$3,252</td> </tr> <tr> <td>D</td> <td>\$3,516</td> </tr> <tr> <td>E</td> <td>\$3,780</td> </tr> <tr> <td>F</td> <td>\$4,191</td> </tr> <tr> <td>G</td> <td>\$4,631</td> </tr> <tr> <td>H</td> <td>\$5,099</td> </tr> <tr> <td>I</td> <td>\$5,832</td> </tr> <tr> <td>J</td> <td>\$6,712</td> </tr> <tr> <td>L1</td> <td>\$5,305</td> </tr> <tr> <td>L2</td> <td>\$5,920</td> </tr> </tbody> </table>	COM	\$2,828	A	\$2,930	B	\$3,048	COL/C	\$3,252	D	\$3,516	E	\$3,780	F	\$4,191	G	\$4,631	H	\$5,099	I	\$5,832	J	\$6,712	L1	\$5,305	L2	\$5,920
		Dimensions	D	W	H																																								
Overall	42	40	44 ½																																										
Seat	20	30	18																																										
Arm		10	25																																										
COM	\$2,828																																												
A	\$2,930																																												
B	\$3,048																																												
COL/C	\$3,252																																												
D	\$3,516																																												
E	\$3,780																																												
F	\$4,191																																												
G	\$4,631																																												
H	\$5,099																																												
I	\$5,832																																												
J	\$6,712																																												
L1	\$5,305																																												
L2	\$5,920																																												
 CTL1304WR right  CTL1304WL left		<table border="1"> <thead> <tr> <th>Upholstery</th> <th colspan="2">Shipping</th> </tr> </thead> <tbody> <tr> <td>COM Ydg</td> <td>6</td> <td>Ctn Wt 163</td> </tr> <tr> <td>COL Sq Ft</td> <td>138</td> <td>Cu Ft 43</td> </tr> </tbody> </table>	Upholstery	Shipping		COM Ydg	6	Ctn Wt 163	COL Sq Ft	138	Cu Ft 43																																		
Upholstery	Shipping																																												
COM Ydg	6	Ctn Wt 163																																											
COL Sq Ft	138	Cu Ft 43																																											
Single Seat Privacy Back	CTL1305UR CTL1305UL <ul style="list-style-type: none"> · upholstered arm · 10" arm width · 30" seat width · 14" high headrest · COM based on single fabric · multiple fabrics, see pages 204-206 for yardage requirements 	<table border="1"> <thead> <tr> <th>Dimensions</th> <th>D</th> <th>W</th> <th>H</th> </tr> </thead> <tbody> <tr> <td>Overall</td> <td>32</td> <td>40</td> <td>51 ½</td> </tr> <tr> <td>Seat</td> <td>20</td> <td>30</td> <td>18</td> </tr> <tr> <td>Arm</td> <td></td> <td>10</td> <td>24 ½</td> </tr> </tbody> </table>	Dimensions	D	W	H	Overall	32	40	51 ½	Seat	20	30	18	Arm		10	24 ½	<table border="1"> <tbody> <tr> <td>COM</td> <td>\$2,022</td> </tr> <tr> <td>A</td> <td>\$2,116</td> </tr> <tr> <td>B</td> <td>\$2,243</td> </tr> <tr> <td>COL/C</td> <td>\$2,466</td> </tr> <tr> <td>D</td> <td>\$2,751</td> </tr> <tr> <td>E</td> <td>\$3,037</td> </tr> <tr> <td>F</td> <td>\$3,482</td> </tr> <tr> <td>G</td> <td>\$3,959</td> </tr> <tr> <td>H</td> <td>\$4,467</td> </tr> <tr> <td>I</td> <td>\$5,261</td> </tr> <tr> <td>J</td> <td>\$6,213</td> </tr> <tr> <td>L1</td> <td>\$4,689</td> </tr> <tr> <td>L2</td> <td>\$5,355</td> </tr> </tbody> </table>	COM	\$2,022	A	\$2,116	B	\$2,243	COL/C	\$2,466	D	\$2,751	E	\$3,037	F	\$3,482	G	\$3,959	H	\$4,467	I	\$5,261	J	\$6,213	L1	\$4,689	L2	\$5,355
		Dimensions	D	W	H																																								
Overall	32	40	51 ½																																										
Seat	20	30	18																																										
Arm		10	24 ½																																										
COM	\$2,022																																												
A	\$2,116																																												
B	\$2,243																																												
COL/C	\$2,466																																												
D	\$2,751																																												
E	\$3,037																																												
F	\$3,482																																												
G	\$3,959																																												
H	\$4,467																																												
I	\$5,261																																												
J	\$6,213																																												
L1	\$4,689																																												
L2	\$5,355																																												
 CTL1305UR right  CTL1305UL left		<table border="1"> <thead> <tr> <th>Upholstery</th> <th colspan="2">Shipping</th> </tr> </thead> <tbody> <tr> <td>COM Ydg</td> <td>6 ½</td> <td>Ctn Wt 123</td> </tr> <tr> <td>COL Sq Ft</td> <td>150</td> <td>Cu Ft 38</td> </tr> </tbody> </table>	Upholstery	Shipping		COM Ydg	6 ½	Ctn Wt 123	COL Sq Ft	150	Cu Ft 38																																		
Upholstery	Shipping																																												
COM Ydg	6 ½	Ctn Wt 123																																											
COL Sq Ft	150	Cu Ft 38																																											

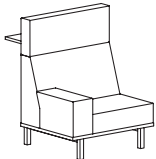
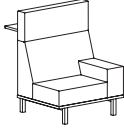
LOUNGE

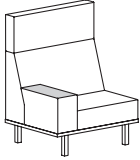
Description	Model	Specifications			List Price Per Grade		
		Dimensions	D	W	H	COM	
Single Seat Privacy Back	CTL1306UR	Overall	42	40	51 ½	A	\$2,829
	CTL1306UL	Seat	20	30	18	B	\$2,936
 CTL1306UR right	<ul style="list-style-type: none"> · upholstered arm · 10" arm width · 30" seat width · 14" high headrest · 41 ¾" high stand up surface · COM based on single fabric · multiple fabrics, see pages 204-206 for yardage requirements 	Arm		10	24 ½	COL/C	\$3,285
		Upholstery		Shipping		D	\$3,572
 CTL1306UL left		COM Ydg	6 ½	Ctn Wt	161	E	\$3,857
		COL Sq Ft	150	Cu Ft	48	F	\$4,301
						G	\$4,778
						H	\$5,286
						I	\$6,080
						J	\$7,033
						L1	\$5,509
						L2	\$6,176

Description	Model	Specifications			List Price Per Grade		
		Dimensions	D	W	H	COM	
Single Seat Privacy Back	CTL1305WR	Overall	32	40	51 ½	A	\$2,152
	CTL1305WL	Seat	20	30	18	B	\$2,376
 CTL1305WR right	<ul style="list-style-type: none"> · wood cap arm · 10" arm width · 30" seat width · 14" high headrest · COM based on single fabric · multiple fabrics, see pages 204-206 for yardage requirements 	Arm		10	25	COL/C	\$2,598
		Upholstery		Shipping		D	\$2,884
 CTL1305WL left		COM Ydg	6 ½	Ctn Wt	128	E	\$3,169
		COL Sq Ft	150	Cu Ft	38	F	\$3,615
						G	\$4,091
						H	\$4,599
						I	\$5,393
						J	\$6,346
						L1	\$4,821
						L2	\$5,488

LOUNGE

To Order, Specify:

- Model Number
- Wood Species - Cherry (CH1), Maple (MA1) or Walnut (WA1)
- Wood Finish
- Laminate Color Selection (Stand up Surface)
- Fabric Selection - vendor, pattern and color
 - Seat
 - Back
 - Arm
 - Headrest
- Metal Leg Color - Black Sandtex (BSX), Soft Nickel (SNK) or Stardust Silver (STS)
- Optional Power Center - Flush Mount (EC22) - Black (B) or White (W); \$504 list each, see page 201 for location availability
- Optional Drink Holder (DH) - add \$84 list each
- Optional Tablet Arm - indicate left (TBL) or right arm (TBR); add \$476 list
- Optional Coordinating Wood Grain Laminate Available on Wood Cap Arm - no upcharge. Finishes with an asterisk have a coordinating laminate available.
- Product Options

Wood Finish Options:

Cherry			
AUT	Autumn*	EAR	Earthy
BRL	Barley*	LGC	Legacy*
BBN	Bourbon*	PRL	Praline*
BRG	Brighton*	SAF	Saffron*
CLA	Classic*		
Maple			
ALE	Ale*	FLX	Flax▲
BUT	Butterscotch	VEN	Venetian*▲
CIN	Cinnamon*		
Walnut			
AUB	Auburn*	TOF	Toffee*
ESP	Espresso	TRF	Truffle*
MCH	Mocha*	SIE	Sienna*
NTO	Night owl*		



Laminate Color Selection (Stand up Surface)

ALB	Alabaster	SHD	Shadow
BBL	Bridal Blanco	SLG	Slate Grey
DWH	Designer White	TAU	Taupe
DOV	Dove Grey		

- See a selection of graded in fabric manufacturers and patterns on pages 12-20. Contact Customer Service for additional fabric options.

Specifications

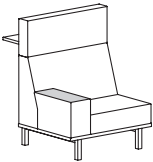
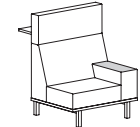
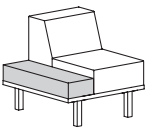
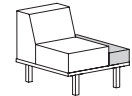
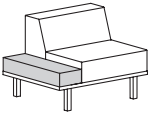
- Wood species - Cherry, Maple or Walnut.
- Seat has synthetic sheet webbing with cross strap reinforcement, 4 ¼" high density polyurethane foam.
- Back has high density polyurethane foam.
- Arms have ¾" thick top and ¼" thick side high density polyurethane foam.
- Plywood construction with locking tenons, glue and screws.
- Linking bracket included.
- Metal legs are 16 gauge steel tube with metal leveling glides.
- ¾" thick 10" deep laminate stand up surface with coordinating 3mm PVC edge supported by steel columns, 42" surface height.

Description	① Model	Specifications	List Price Per Grade																												
Single Seat Privacy Back  CTL1306WR right  CTL1306WL left	CTL1306WR CTL1306WL <ul style="list-style-type: none"> · wood cap arm · 10" arm width · 30" seat width · 14" high headrest · 41 ¾" high stand up surface · COM based on single fabric · multiple fabrics, see pages 204-206 for yardage requirements 	<table border="1"> <thead> <tr> <th>Dimensions</th> <th>D</th> <th>W</th> <th>H</th> </tr> </thead> <tbody> <tr> <td>Overall</td> <td>42</td> <td>40</td> <td>51 ½</td> </tr> <tr> <td>Seat</td> <td>20</td> <td>30</td> <td>18</td> </tr> <tr> <td>Arm</td> <td></td> <td>10</td> <td>25</td> </tr> <tr> <th colspan="2">Upholstery</th> <th colspan="2">Shipping</th> </tr> <tr> <td>COM Ydg</td> <td>6 ½</td> <td>Ctn Wt</td> <td>166</td> </tr> <tr> <td>COL Sq Ft</td> <td>150</td> <td>Cu Ft</td> <td>48</td> </tr> </tbody> </table>	Dimensions	D	W	H	Overall	42	40	51 ½	Seat	20	30	18	Arm		10	25	Upholstery		Shipping		COM Ydg	6 ½	Ctn Wt	166	COL Sq Ft	150	Cu Ft	48	COM \$2,959 A \$3,069 B \$3,196 COL/C \$3,417 D \$3,704 E \$3,989 F \$4,434 G \$4,910 H \$5,418 I \$6,212 J \$7,166 L1 \$5,641 L2 \$6,308
		Dimensions	D	W	H																										
Overall	42	40	51 ½																												
Seat	20	30	18																												
Arm		10	25																												
Upholstery		Shipping																													
COM Ydg	6 ½	Ctn Wt	166																												
COL Sq Ft	150	Cu Ft	48																												
Single Seat Low Back  CTL1201CR right  CTL1201CL left	CTL1201CR CTL1201CL <ul style="list-style-type: none"> · 20" seat width · 10" table width · COM based on single fabric · multiple fabrics, see pages 204-206 for yardage requirements 	<table border="1"> <thead> <tr> <th>Dimensions</th> <th>D</th> <th>W</th> <th>H</th> </tr> </thead> <tbody> <tr> <td>Overall</td> <td>32</td> <td>30</td> <td>30 ½</td> </tr> <tr> <td>Seat</td> <td>20</td> <td>20</td> <td>18</td> </tr> <tr> <th colspan="2">Upholstery</th> <th colspan="2">Shipping</th> </tr> <tr> <td>COM Ydg</td> <td>3 ½</td> <td>Ctn Wt</td> <td>82</td> </tr> <tr> <td>COL Sq Ft</td> <td>81</td> <td>Cu Ft</td> <td>16</td> </tr> </tbody> </table>	Dimensions	D	W	H	Overall	32	30	30 ½	Seat	20	20	18	Upholstery		Shipping		COM Ydg	3 ½	Ctn Wt	82	COL Sq Ft	81	Cu Ft	16	COM \$1,574 A \$1,633 B \$1,701 COL/C \$1,821 D \$1,974 E \$2,129 F \$2,368 G \$2,624 H \$2,898 I \$3,326 J \$3,839 L1 \$3,018 L2 \$3,377				
		Dimensions	D	W	H																										
Overall	32	30	30 ½																												
Seat	20	20	18																												
Upholstery		Shipping																													
COM Ydg	3 ½	Ctn Wt	82																												
COL Sq Ft	81	Cu Ft	16																												
Single Seat Low Back  CTL1301CR right  CTL1301CL left	CTL1301CR CTL1301CL <ul style="list-style-type: none"> · 30" seat width · 10" table width · COM based on single fabric · multiple fabrics, see pages 204-206 for yardage requirements 	<table border="1"> <thead> <tr> <th>Dimensions</th> <th>D</th> <th>W</th> <th>H</th> </tr> </thead> <tbody> <tr> <td>Overall</td> <td>32</td> <td>40</td> <td>30 ½</td> </tr> <tr> <td>Seat</td> <td>20</td> <td>30</td> <td>18</td> </tr> <tr> <th colspan="2">Upholstery</th> <th colspan="2">Shipping</th> </tr> <tr> <td>COM Ydg</td> <td>3 ½</td> <td>Ctn Wt</td> <td>93</td> </tr> <tr> <td>COL Sq Ft</td> <td>81</td> <td>Cu Ft</td> <td>21</td> </tr> </tbody> </table>	Dimensions	D	W	H	Overall	32	40	30 ½	Seat	20	30	18	Upholstery		Shipping		COM Ydg	3 ½	Ctn Wt	93	COL Sq Ft	81	Cu Ft	21	COM \$1,671 A \$1,731 B \$1,799 COL/C \$1,919 D \$2,073 E \$2,226 F \$2,466 G \$2,723 H \$2,996 I \$3,425 J \$3,937 L1 \$3,116 L2 \$3,475				
		Dimensions	D	W	H																										
Overall	32	40	30 ½																												
Seat	20	30	18																												
Upholstery		Shipping																													
COM Ydg	3 ½	Ctn Wt	93																												
COL Sq Ft	81	Cu Ft	21																												

LOUNGE

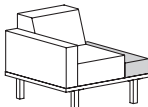
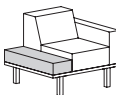
Description	① Model	Specifications			List Price Per Grade		
		Dimensions	D	W	H	COM	
Single Seat Low Back  CTL1201URCL right  CTL1201ULCR left	CTL1201URCL CTL1201ULCR · upholstered arm · 5" arm width · 20" seat width · 10" table width · COM based on single fabric · multiple fabrics, see pages 204-206 for yardage requirements	Overall	32	35	30½	COM	\$1,998
		Seat	20	20	18	COL/C	\$2,346
		Arm		5	24½	D	\$2,566
		Upholstery		Shipping		E	\$2,786
		COM Ydg	5	Ctn Wt	85	F	\$3,127
		COL Sq Ft	115	Cu Ft	19	G	\$3,494
						H	\$3,885
						I	\$4,496
						J	\$5,229
						L1	\$4,057
						L2	\$4,569

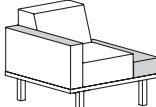
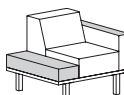
Description	① Model	Specifications			List Price Per Grade		
		Dimensions	D	W	H	COM	
Single Seat Low Back  CTL1201WRCL right  CTL1201WLCR left	CTL1201WRCL CTL1201WLCR · wood cap arm · 5" arm width · 20" seat width · 10" table width · COM based on single fabric · multiple fabrics, see pages 204-206 for yardage requirements	Overall	32	35	30½	COM	\$2,128
		Seat	20	20	18	COL/C	\$2,478
		Arm		5	25	D	\$2,698
		Upholstery		Shipping		E	\$2,917
		COM Ydg	5	Ctn Wt	89	F	\$3,260
		COL Sq Ft	115	Cu Ft	19	G	\$3,626
						H	\$4,018
						I	\$4,628
						J	\$5,361
						L1	\$4,188
						L2	\$4,701

To Order, Specify:

- ① Model Number
- ② Wood Species - Cherry (CH1), Maple (MA1) or Walnut (WA1)
- ③ Wood Finish
- ④ Laminate Color Selection (Stand up Surface)
- ⑤ Fabric Selection - vendor, pattern and color
 - A. Seat
 - B. Back
 - C. Arm
 - D. Headrest
- ⑥ Metal Leg Color - Black Sandtex (BSX), Soft Nickel (SNK) or Stardust Silver (STS)
- ⑦ Optional Power Center - Flush Mount (EC22) - Black (B) or White (W); \$504 list each, see page 201 for location availability
- ⑧ Optional Drink Holder(s) (DH) - add \$84 list each, indicate left or right arm; add \$168 list for end table
- ⑨ Optional Tablet Arm - indicate left (TBL) or right arm (TBR); add \$476 list
- ▲ ⑩ Optional Coordinating Wood Grain Laminate Available on Wood Cap Arm or Table Top - no upcharge. Finishes with an asterisk have a coordinating laminate available
- ⑪ Product Options

③ Wood Finish Options:

Cherry		EAR	Earthy
AUT	Autumn*	LGC	Legacy*
BRL	Barley*	PRL	Praline*
BBN	Bourbon*	SAF	Saffron*
BRG	Brighton*		
CLA	Classic*		
Maple		FLX	Flax ▲
ALE	Ale*	VEN	Venetian* ▲
BUT	Butterscotch		
CIN	Cinnamon*		
Walnut		TOF	Toffee*
AUB	Auburn*	TRF	Truffle*
ESP	Espresso	SIE	Sienna*
MCH	Mocha*		
NTO	Night owl*		



④ Laminate Color Selection (Stand Up Surface)



ALB	Alabaster	SHD	Shadow
BBL	Bridal Blanco	SLG	Slate Grey
DWH	Designer White	TAU	Taupe
DOV	Dove Grey		

- ⑤ See a selection of graded in fabric manufacturers and patterns on pages 12-20. Contact Customer Service for additional fabric options.

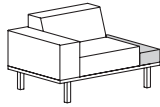
Specifications

- Wood species - Cherry, Maple or Walnut.
- Seat has synthetic sheet webbing with cross strap reinforcement, 4 ¼" high density polyurethane foam.
- Back has high density polyurethane foam.
- Arms have ¾" thick top and ¼" thick side high density polyurethane foam.
- Plywood construction with locking tenons, glue and screws.
- Linking bracket included.
- Metal legs are 16 gauge steel tube with metal leveling glides.
- ¾" thick 10" deep laminate stand up surface with coordinating 3mm PVC edge supported by steel columns, 42" surface height.

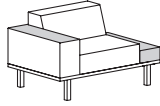
Description	① Model	Specifications				List Price Per Grade
		Dimensions	D	W	H	
Single Seat Low Back  CTL1301URCL right	CTL1301URCL CTL1301ULCR · upholstered arm · 10" arm width · 30" seat width · 10" table width · COM based on single fabric · multiple fabrics, see pages 204-206 for yardage requirements	Overall	32	50	30 ½	COM \$2,125 A \$2,207 B \$2,304 COL/C \$2,475 D \$2,695 E \$2,914 F \$3,257 G \$3,623 H \$4,015 I \$4,625 J \$5,358 L1 \$4,185 L2 \$4,698
		Seat	20	30	18	
Single Seat Low Back  CTL1301ULCR▲ left		Arm		10	24 ½	
		Upholstery		Shipping		
		COM Ydg	5	Ctn Wt	120	
		COL Sq Ft	115	Cu Ft	26	

Description	① Model	Specifications				List Price Per Grade
		Dimensions	D	W	H	
Single Seat Low Back  CTL1301WRCL right	CTL1301WRCL CTL1301WLCR · wood cap arm · 10" arm width · 30" seat width · 10" table width · COM based on single fabric · multiple fabrics, see pages 204-206 for yardage requirements	Overall	32	50	30 ½	COM \$2,256 A \$2,339 B \$2,438 COL/C \$2,608 D \$2,828 E \$3,048 F \$3,390 G \$3,756 H \$4,147 I \$4,758 J \$5,491 L1 \$4,318 L2 \$4,832
		Seat	20	30	18	
Single Seat Low Back  CTL1301WLCR left		Arm		10	25	
		Upholstery		Shipping		
		COM Ydg	5	Ctn Wt	125	
		COL Sq Ft	115	Cu Ft	26	

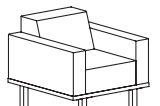
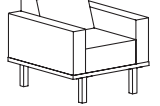
Description	① Model	Specifications				List Price Per Grade
		Dimensions	D	W	H	
Single Seat Low Back  CTL1201U2	· upholstered arms · 5" arm width · 20" seat width · COM based on single fabric · multiple fabrics, see pages 204-206 for yardage requirements	Overall	32	30	30 ½	COM \$1,921 A \$2,014 B \$2,141 COL/C \$2,363 D \$2,650 E \$2,935 F \$3,379 G \$3,856 H \$4,364 I \$5,158 J \$6,111 L1 \$4,587 L2 \$5,254
		Seat	20	20	18	
Single Seat Low Back  CTL1201U2		Arm		5	24 ½	
		Upholstery		Shipping		
		COM Ydg	6 ½	Ctn Wt	76	
		COL Sq Ft	150	Cu Ft	16	

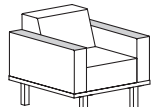
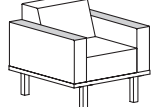
Description	① Model	Specifications				List Price Per Grade
		Dimensions	D	W	H	
Single Seat Low Back  CTL1201W2	· wood cap arms · 5" arm width · 20" seat width · COM based on single fabric · multiple fabrics, see pages 204-206 for yardage requirements	Overall	32	30	30 ½	COM \$2,183 A \$2,280 B \$2,407 COL/C \$2,630 D \$2,915 E \$3,202 F \$3,646 G \$4,123 H \$4,631 I \$5,425 J \$6,378 L1 \$4,854 L2 \$5,520
		Seat	20	20▲	18	
Single Seat Low Back  CTL1201W2		Arm		5	25	
		Upholstery		Shipping		
		COM Ydg	6 ½	Ctn Wt	81	
		COL Sq Ft	150	Cu Ft	16	

LOUNGE

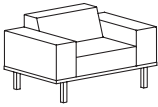
Description	① Model	Specifications			List Price Per Grade		
		Dimensions	D	W	H	COM	
Single Seat Low Back 	CTL1301U2 • upholstered arms • 10" arm width • 30" seat width • COM based on single fabric • multiple fabrics, see pages 204-206 for yardage requirements	Overall	32	50	30½	COM	\$2,077
		Seat	20	30	18	A	\$2,173
		Arm		10	24½	B	\$2,300
		Upholstery		Shipping		COL/C	\$2,523
		COM Ydg	6½	Ctn Wt	131	D	\$2,808
		COL Sq Ft	150	Cu Ft	26	E	\$3,094
						F	\$3,539
						G	\$4,015
						H	\$4,523
						I	\$5,318
						J	\$6,270
						L1	\$4,745
						L2	\$5,412

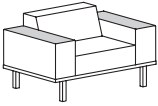
Description	① Model	Specifications			List Price Per Grade		
		Dimensions	D	W	H	COM	
Single Seat Low Back 	CTL1301W2 • wood cap arms • 10" arm width • 30" seat width • COM based on single fabric • multiple fabrics, see pages 204-206 for yardage requirements	Overall	32	50	30½	COM	\$2,342
		Seat	20	30	18	A	\$2,442
		Arm		10	25	B	\$2,569
		Upholstery		Shipping		COL/C	\$2,790
		COM Ydg	6½	Ctn Wt	141	D	\$3,077
		COL Sq Ft	150	Cu Ft	26	E	\$3,363
						F	\$3,807
						G	\$4,283
						H	\$4,792
						I	\$5,585
						J	\$6,539
						L1	\$5,014
						L2	\$5,681

To Order, Specify:

- ① Model Number
- ② Wood Species - Cherry (CH1), Maple (MA1) or Walnut (WA1)
- ③ Wood Finish
- ④ Fabric Selection - vendor, pattern and color
 - A. Seat
 - B. Back
 - C. Arm(s)
- ⑤ Metal Leg Color - Black Sandtex (BSX), Soft Nickel (SNK) or Stardust Silver (STS)
- ⑥ Optional Wood Back Rail - available on any unit with two arms, specify and add \$136 list
- ⑦ Optional Power Center - Flush Mount (EC22) - Black (B) or White (W); \$504 list each, see page 201 for location availability
- ⑧ Optional Drink Holder(s) (DH) - add \$84 list each, indicate left or right arm; add \$168 list for end table
- ⑨ Optional Tablet Arm - indicate left (TBL) or right arm (TBR); add \$476 list
- ▲ ⑩ Optional Coordinating Wood Grain Laminate Available on Wood Cap Arm or Table Top - no upcharge. Finishes with an asterisk have a coordinating laminate available
- ⑪ Product Options

③ Wood Finish Options:

Cherry			
AUT	Autumn*	EAR	Earthy
BRL	Barley*	LGC	Legacy*
BBN	Bourbon*	PRL	Praline*
BRG	Brighton*	SAF	Saffron*
CLA	Classic*		
Maple			
ALE	Ale*	FLX	Flax ▲
BUT	Butterscotch	VEN	Venetian* ▲
CIN	Cinnamon*		
Walnut			
AUB	Auburn*	TOF	Toffee*
ESP	Espresso	TRF	Truffle*
MCH	Mocha*	SIE	Sienna*
NTO	Night owl*		

- ④ See a selection of graded in fabric manufacturers and patterns on pages 12-20. Contact Customer Service for additional fabric options.

Specifications

- Wood species - Cherry, Maple or Walnut.
- Seat has synthetic sheet webbing with cross strap reinforcement, 4 ¼" high density polyurethane foam.
- Back has high density polyurethane foam.
- Arms have ¾" thick top and ¼" thick side high density polyurethane foam.
- Plywood construction with locking tenons, glue and screws.
- Linking bracket included.
- Metal legs are 16 gauge steel tube with metal leveling glides.

When ordering Quickship products, place a "Q" in front of model number.
Example: QGT4901D

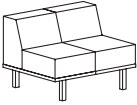
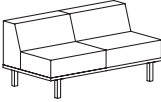
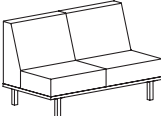
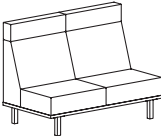

Description	① Model	Specifications				List Price Per Grade	
Two Seat Low Back 	CTL2201 · armless · 20" individual seat width · COM based on single fabric · multiple fabrics, see pages 204-206 for yardage requirements	Dimensions		D	W	H	COM \$2,137 A \$2,238 B \$2,376 COL/C \$2,615 D \$2,923 E \$3,230 F \$3,709 G \$4,223 H \$4,770 I \$5,625 J \$6,651 L1 \$5,009 L2 \$5,727
		Overall	32	40	30 ½	Seat	
		Upholstery		Shipping			
		COM Ydg	7	Ctn Wt	93		
		COL Sq Ft	161	Cu Ft	21		
Two Seat Low Back 	CTL2301 · armless · 30" individual seat width · COM based on single fabric · multiple fabrics, see pages 204-206 for yardage requirements	Dimensions		D	W	H	COM \$2,341 A \$2,445 B \$2,582 COL/C \$2,822 D \$3,129 E \$3,437 F \$3,916 G \$4,429 H \$4,976 I \$5,832 J \$6,858 L1 \$5,216 L2 \$5,934
		Overall	32	60	30 ½	Seat	
		Upholstery		Shipping			
		COM Ydg	7	Ctn Wt	138		
		COL Sq Ft	161	Cu Ft	31		
Two Seat Mid Back 	CTL2302 · armless · 30" individual seat width · COM based on single fabric · multiple fabrics, see pages 204-206 for yardage requirements	Dimensions		D	W	H	COM \$2,606 A \$2,719 B \$2,865 COL/C \$3,122 D \$3,452 E \$3,782 F \$4,295 G \$4,844 H \$5,431 I \$6,347 J \$7,446 L1 \$5,687 L2 \$6,457
		Overall	32	60	37 ½	Seat	
		Upholstery		Shipping			
		COM Ydg	7 ½	Ctn Wt	143		
		COL Sq Ft	173	Cu Ft	39		
Two Seat High Back 	CTL2303 · armless · 30" individual seat width · COM based on single fabric · multiple fabrics, see pages 204-206 for yardage requirements	Dimensions		D	W	H	COM \$2,868 A \$3,000 B \$3,176 COL/C \$3,483 D \$3,879 E \$4,275 F \$4,891 G \$5,551 H \$6,254 I \$7,354 J \$8,673 L1 \$6,562 L2 \$7,485
		Overall	32	60	44 ½	Seat	
		Upholstery		Shipping			
		COM Ydg	9	Ctn Wt	160		
		COL Sq Ft	207	Cu Ft	48		

LOUNGE

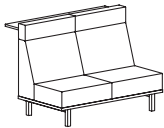
Description	Model	Specifications			List Price Per Grade		
		Dimensions	D	W	H	COM	
Two Seat High Back 	CTL2304 · armless · 30" individual seat width · 7" high headrest · 41 ¾" high stand up surface · COM based on single fabric · multiple fabrics, see pages 204-206 for yardage requirements	Overall	42	60	44 ½	COM	\$3,699
		Seat	20	60	18	A	\$3,842
		Upholstery		Shipping		B	\$4,019
		COM Ydg	9	Ctn Wt	198	COL/C	\$4,326
		COL Sq Ft	207	Cu Ft	58	D	\$4,722
						E	\$5,118
						F	\$5,735
						G	\$6,394
						H	\$7,097
						I	\$8,197
				J	\$9,517		
				L1	\$7,405		
				L2	\$8,328		

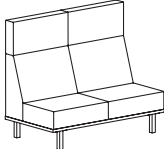
Description	Model	Specifications			List Price Per Grade		
		Dimensions	D	W	H	COM	
Two Seat Privacy Back 	CTL2305 · armless · 30" individual seat width · 14" high headrest · COM based on single fabric · multiple fabrics, see pages 204-206 for yardage requirements	Overall	32	60	51 ½	COM	\$3,131
		Seat	20	60	18	A	\$3,276
		Upholstery		Shipping		B	\$3,472
		COM Ydg	10	Ctn Wt	164	COL/C	\$3,814
		COL Sq Ft	230	Cu Ft	56	D	\$4,253
						E	\$4,693
						F	\$5,378
						G	\$6,110
						H	\$6,893
						I	\$8,114
				J	\$9,580		
				L1	\$7,234		
				L2	\$8,260		

To Order, Specify:

- 1 Model Number
- 2 Wood Species - Cherry (CH1), Maple (MA1) or Walnut (WA1)
- 3 Wood Finish
- 4 Laminate Color Selection (Stand up Surface)
- 5 Fabric Selection - vendor, pattern and color
 - A. Seat
 - B. Back
 - C. Arm
 - D. Headrest
- 6 Metal Leg Color - Black Sandtex (BSX), Soft Nickel (SNK) or Stardust Silver (STS)
- 7 Optional Power Center - Flush Mount (EC22) - Black (B) or White (W); \$504 list each, see page 201 for location availability
- 8 Optional Drink Holder (DH) - add \$84 list each
- 9 Optional Tablet Arm - indicate left (TBL) or right arm (TBR); add \$476 list
- 10 Product Options

3 Wood Finish Options:

Cherry			
AUT	Autumn	EAR	Earthy
BRL	Barley	LGC	Legacy
BBN	Bourbon	PRL	Praline
BRG	Brighton	SAF	Saffron
CLA	Classic		
Maple			
ALE	Ale	FLX	Flax▲
BUT	Butterscotch	VEN	Venetian▲
CIN	Cinnamon		
Walnut			
AUB	Auburn	TOF	Toffee
ESP	Espresso	TRF	Truffie
MCH	Mocha	SIE	Sienna
NTO	Night owl		

4 Laminate Color Selection (Stand up Surface)

ALB	Alabaster	SHD	Shadow
BBL	Bridal Blanco	SLG	Slate Grey
DWH	Designer White	TAU	Taupe
DOV	Dove Grey		



- 5 See a selection of graded in fabric manufacturers and patterns on pages 12-20. Contact Customer Service for additional fabric options.

Specifications

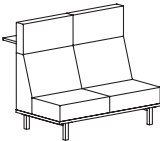
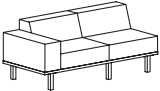
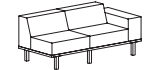
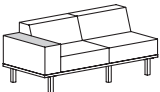
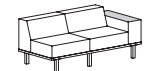
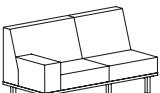
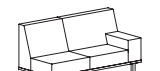
- Wood species - Cherry, Maple or Walnut.
- Seat has synthetic sheet webbing with cross strap reinforcement, 4 ¼" high density polyurethane foam.
- Back has high density polyurethane foam.
- Arms have ¾" thick top and ¼" thick side high density polyurethane foam.
- Plywood construction with locking tenons, glue and screws.
- Linking bracket included.
- Metal legs are 16 gauge steel tube with metal leveling glides.
- ¾" thick 10" deep laminate stand up surface with coordinating 3mm PVC edge supported by steel columns, 42" surface height.

Description	① Model	Specifications	List Price Per Grade																
Two Seat Privacy Back 	CTL2306 · armless · 30" individual seat width · 14" high headrest · 41 ¾" high stand up surface · COM based on single fabric · multiple fabrics, see pages 204-206 for yardage requirements	<table border="1"> <thead> <tr> <th>Dimensions</th> <th>D</th> <th>W</th> <th>H</th> </tr> </thead> <tbody> <tr> <td>Overall</td> <td>42</td> <td>60</td> <td>51 ½</td> </tr> <tr> <td>Seat</td> <td>20</td> <td>60</td> <td>18</td> </tr> </tbody> </table>	Dimensions	D	W	H	Overall	42	60	51 ½	Seat	20	60	18	COM \$3,961 A \$4,120 B \$4,315 COL/C \$4,657 D \$5,096 E \$5,536 F \$6,221 G \$6,954 H \$7,735 I \$8,957 J \$10,423 L1 \$8,077 L2 \$9,103				
		Dimensions	D	W	H														
Overall	42	60	51 ½																
Seat	20	60	18																
<table border="1"> <thead> <tr> <th>Upholstery</th> <th>Shipping</th> </tr> </thead> <tbody> <tr> <td>COM Ydg</td> <td>10 Ctn Wt 202</td> </tr> <tr> <td>COL Sq Ft</td> <td>230 Cu Ft 66</td> </tr> </tbody> </table>	Upholstery	Shipping	COM Ydg	10 Ctn Wt 202	COL Sq Ft	230 Cu Ft 66													
Upholstery	Shipping																		
COM Ydg	10 Ctn Wt 202																		
COL Sq Ft	230 Cu Ft 66																		
Two Seat Low Back  CTL2301UR right  CTL2301UL left	CTL2301UR CTL2301UL · upholstered arm · 10" arm width · 30" individual seat width · COM based on single fabric · multiple fabrics, see pages 204-206 for yardage requirements	<table border="1"> <thead> <tr> <th>Dimensions</th> <th>D</th> <th>W</th> <th>H</th> </tr> </thead> <tbody> <tr> <td>Overall</td> <td>32</td> <td>70</td> <td>30 ½</td> </tr> <tr> <td>Seat</td> <td>20</td> <td>60</td> <td>18</td> </tr> <tr> <td>Arm</td> <td></td> <td>10</td> <td>24 ½</td> </tr> </tbody> </table>	Dimensions	D	W	H	Overall	32	70	30 ½	Seat	20	60	18	Arm		10	24 ½	COM \$2,797 A \$2,923 B \$3,089 COL/C \$3,379 D \$3,753 E \$4,127 F \$4,709 G \$5,331 H \$5,996 I \$7,034 J \$8,281 L1 \$6,287 L2 \$7,158
		Dimensions	D	W	H														
Overall	32	70	30 ½																
Seat	20	60	18																
Arm		10	24 ½																
<table border="1"> <thead> <tr> <th>Upholstery</th> <th>Shipping</th> </tr> </thead> <tbody> <tr> <td>COM Ydg</td> <td>8 ½ Ctn Wt 187</td> </tr> <tr> <td>COL Sq Ft</td> <td>196 Cu Ft 36</td> </tr> </tbody> </table>	Upholstery	Shipping	COM Ydg	8 ½ Ctn Wt 187	COL Sq Ft	196 Cu Ft 36													
Upholstery	Shipping																		
COM Ydg	8 ½ Ctn Wt 187																		
COL Sq Ft	196 Cu Ft 36																		
Two Seat Low Back  CTL2301WR right  CTL2301WL left	CTL2301WR CTL2301WL · wood cap arm · 10" arm width · 30" individual seat width · COM based on single fabric · multiple fabrics, see pages 204-206 for yardage requirements	<table border="1"> <thead> <tr> <th>Dimensions</th> <th>D</th> <th>W</th> <th>H</th> </tr> </thead> <tbody> <tr> <td>Overall</td> <td>32</td> <td>70</td> <td>30 ½</td> </tr> <tr> <td>Seat</td> <td>20</td> <td>60</td> <td>18</td> </tr> <tr> <td>Arm</td> <td></td> <td>10</td> <td>25</td> </tr> </tbody> </table>	Dimensions	D	W	H	Overall	32	70	30 ½	Seat	20	60	18	Arm		10	25	COM \$2,927 A \$3,055 B \$3,221 COL/C \$3,512 D \$3,885 E \$4,259 F \$4,841 G \$5,464 H \$6,128 I \$7,167 J \$8,413 L1 \$6,419 L2 \$7,291
		Dimensions	D	W	H														
Overall	32	70	30 ½																
Seat	20	60	18																
Arm		10	25																
<table border="1"> <thead> <tr> <th>Upholstery</th> <th>Shipping</th> </tr> </thead> <tbody> <tr> <td>COM Ydg</td> <td>8 ½ Ctn Wt 192</td> </tr> <tr> <td>COL Sq Ft</td> <td>196 Cu Ft 36</td> </tr> </tbody> </table>	Upholstery	Shipping	COM Ydg	8 ½ Ctn Wt 192	COL Sq Ft	196 Cu Ft 36													
Upholstery	Shipping																		
COM Ydg	8 ½ Ctn Wt 192																		
COL Sq Ft	196 Cu Ft 36																		
Two Seat Mid Back  CTL2302UR right  CTL2302UL left	CTL2302UR CTL2302UL · upholstered arm · 10" arm width · 30" individual seat width · COM based on single fabric · multiple fabrics, see pages 204-206 for yardage requirements	<table border="1"> <thead> <tr> <th>Dimensions</th> <th>D</th> <th>W</th> <th>H</th> </tr> </thead> <tbody> <tr> <td>Overall</td> <td>32</td> <td>70</td> <td>37 ½</td> </tr> <tr> <td>Seat</td> <td>20</td> <td>60</td> <td>18</td> </tr> <tr> <td>Arm</td> <td></td> <td>10</td> <td>24 ½</td> </tr> </tbody> </table>	Dimensions	D	W	H	Overall	32	70	37 ½	Seat	20	60	18	Arm		10	24 ½	COM \$3,059 A \$3,194 B \$3,370 COL/C \$3,678 D \$4,073 E \$4,469 F \$5,085 G \$5,745 H \$6,449 I \$7,548 J \$8,868 L1 \$6,756 L2 \$7,679
		Dimensions	D	W	H														
Overall	32	70	37 ½																
Seat	20	60	18																
Arm		10	24 ½																
<table border="1"> <thead> <tr> <th>Upholstery</th> <th>Shipping</th> </tr> </thead> <tbody> <tr> <td>COM Ydg</td> <td>9 Ctn Wt 187</td> </tr> <tr> <td>COL Sq Ft</td> <td>207 Cu Ft 46</td> </tr> </tbody> </table>	Upholstery	Shipping	COM Ydg	9 Ctn Wt 187	COL Sq Ft	207 Cu Ft 46													
Upholstery	Shipping																		
COM Ydg	9 Ctn Wt 187																		
COL Sq Ft	207 Cu Ft 46																		

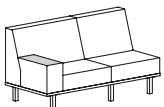
LOUNGE

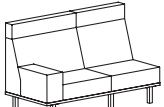
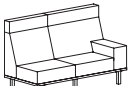
Description	Model	Specifications	List Price Per Grade																																																			
Two Seat Mid Back  CTL2302WR right  CTL2302WL left	CTL2302WR CTL2302WL <ul style="list-style-type: none"> • wood cap arm • 10" arm width • 30" individual seat width • COM based on single fabric • multiple fabrics, see pages 204-206 for yardage requirements 	<table border="1"> <thead> <tr> <th>Dimensions</th> <th>D</th> <th>W</th> <th>H</th> </tr> </thead> <tbody> <tr> <td>Overall</td> <td>32</td> <td>70</td> <td>37½</td> </tr> <tr> <td>Seat</td> <td>20</td> <td>60</td> <td>18</td> </tr> <tr> <td>Arm</td> <td></td> <td>10</td> <td>25</td> </tr> </tbody> </table> <table border="1"> <thead> <tr> <th>Upholstery</th> <th colspan="2">Shipping</th> </tr> </thead> <tbody> <tr> <td>COM Ydg</td> <td>9</td> <td>Ctn Wt 192</td> </tr> <tr> <td>COL Sq Ft</td> <td>207</td> <td>Cu Ft 46</td> </tr> </tbody> </table>	Dimensions	D	W	H	Overall	32	70	37½	Seat	20	60	18	Arm		10	25	Upholstery	Shipping		COM Ydg	9	Ctn Wt 192	COL Sq Ft	207	Cu Ft 46	<table border="1"> <tbody> <tr><td>COM</td><td>\$3,189</td></tr> <tr><td>A</td><td>\$3,326</td></tr> <tr><td>B</td><td>\$3,502</td></tr> <tr><td>COL/C</td><td>\$3,810</td></tr> <tr><td>D</td><td>\$4,206</td></tr> <tr><td>E</td><td>\$4,602</td></tr> <tr><td>F</td><td>\$5,217</td></tr> <tr><td>G</td><td>\$5,877</td></tr> <tr><td>H</td><td>\$6,581</td></tr> <tr><td>I</td><td>\$7,680</td></tr> <tr><td>J</td><td>\$8,999</td></tr> <tr><td>L1</td><td>\$6,888</td></tr> <tr><td>L2</td><td>\$7,811</td></tr> </tbody> </table>	COM	\$3,189	A	\$3,326	B	\$3,502	COL/C	\$3,810	D	\$4,206	E	\$4,602	F	\$5,217	G	\$5,877	H	\$6,581	I	\$7,680	J	\$8,999	L1	\$6,888	L2	\$7,811
		Dimensions	D	W	H																																																	
Overall	32	70	37½																																																			
Seat	20	60	18																																																			
Arm		10	25																																																			
Upholstery	Shipping																																																					
COM Ydg	9	Ctn Wt 192																																																				
COL Sq Ft	207	Cu Ft 46																																																				
COM	\$3,189																																																					
A	\$3,326																																																					
B	\$3,502																																																					
COL/C	\$3,810																																																					
D	\$4,206																																																					
E	\$4,602																																																					
F	\$5,217																																																					
G	\$5,877																																																					
H	\$6,581																																																					
I	\$7,680																																																					
J	\$8,999																																																					
L1	\$6,888																																																					
L2	\$7,811																																																					
Two Seat High Back  CTL2303UR right  CTL2303UL left	CTL2303UR CTL2303UL <ul style="list-style-type: none"> • upholstered arm • 10" arm width • 30" individual seat width • 7" high headrest • COM based on single fabric • multiple fabrics, see pages 204-206 for yardage requirements 	<table border="1"> <thead> <tr> <th>Dimensions</th> <th>D</th> <th>W</th> <th>H</th> </tr> </thead> <tbody> <tr> <td>Overall</td> <td>32</td> <td>70</td> <td>44½</td> </tr> <tr> <td>Seat</td> <td>20</td> <td>60</td> <td>18</td> </tr> <tr> <td>Arm</td> <td></td> <td>10</td> <td>24½</td> </tr> </tbody> </table> <table border="1"> <thead> <tr> <th>Upholstery</th> <th colspan="2">Shipping</th> </tr> </thead> <tbody> <tr> <td>COM Ydg</td> <td>10½</td> <td>Ctn Wt 204</td> </tr> <tr> <td>COL Sq Ft</td> <td>242</td> <td>Cu Ft 56</td> </tr> </tbody> </table>	Dimensions	D	W	H	Overall	32	70	44½	Seat	20	60	18	Arm		10	24½	Upholstery	Shipping		COM Ydg	10½	Ctn Wt 204	COL Sq Ft	242	Cu Ft 56	<table border="1"> <tbody> <tr><td>COM</td><td>\$3,322</td></tr> <tr><td>A</td><td>\$3,475</td></tr> <tr><td>B</td><td>\$3,681</td></tr> <tr><td>COL/C</td><td>\$4,040</td></tr> <tr><td>D</td><td>\$4,501</td></tr> <tr><td>E</td><td>\$4,963</td></tr> <tr><td>F</td><td>\$5,681</td></tr> <tr><td>G</td><td>\$6,451</td></tr> <tr><td>H</td><td>\$7,272</td></tr> <tr><td>I</td><td>\$8,555</td></tr> <tr><td>J</td><td>\$10,094</td></tr> <tr><td>L1</td><td>\$7,631</td></tr> <tr><td>L2</td><td>\$8,708</td></tr> </tbody> </table>	COM	\$3,322	A	\$3,475	B	\$3,681	COL/C	\$4,040	D	\$4,501	E	\$4,963	F	\$5,681	G	\$6,451	H	\$7,272	I	\$8,555	J	\$10,094	L1	\$7,631	L2	\$8,708
		Dimensions	D	W	H																																																	
Overall	32	70	44½																																																			
Seat	20	60	18																																																			
Arm		10	24½																																																			
Upholstery	Shipping																																																					
COM Ydg	10½	Ctn Wt 204																																																				
COL Sq Ft	242	Cu Ft 56																																																				
COM	\$3,322																																																					
A	\$3,475																																																					
B	\$3,681																																																					
COL/C	\$4,040																																																					
D	\$4,501																																																					
E	\$4,963																																																					
F	\$5,681																																																					
G	\$6,451																																																					
H	\$7,272																																																					
I	\$8,555																																																					
J	\$10,094																																																					
L1	\$7,631																																																					
L2	\$8,708																																																					

To Order, Specify:

- 1 Model Number
- 2 Wood Species - Cherry (CH1), Maple (MA1) or Walnut (WA1)
- 3 Wood Finish
- 4 Laminate Color Selection (Stand up Surface)
- 5 Fabric Selection - vendor, pattern and color
 - A. Seat
 - B. Back
 - C. Arm
 - D. Headrest
- 6 Metal Leg Color - Black Sandtex (BSX), Soft Nickel (SNK) or Stardust Silver (STS)
- 7 Optional Power Center - Flush Mount (EC22) - Black (B) or White (W); \$504 list each, see page 201 for location availability
- 8 Optional Drink Holder (DH) - add \$84 list each
- 9 Optional Tablet Arm - indicate left (TBL) or right arm (TBR); add \$476 list
- 10 Optional Coordinating Wood Grain Laminate Available on Wood Cap Arm - no upcharge. Finishes with an asterisk have a coordinating laminate available.
- 11 Product Options

3 Wood Finish Options:

Cherry		EAR	Earthy
AUT	Autumn*	LGC	Legacy*
BRL	Barley*	PRL	Praline*
BBN	Bourbon*	SAF	Saffron*
BRG	Brighton*		
CLA	Classic*		
Maple		FLX	Flax▲
ALE	Ale*	VEN	Venetian*▲
BUT	Butterscotch		
CIN	Cinnamon*		
Walnut		TOF	Toffee*
AUB	Auburn*	TRF	Truffe*
ESP	Espresso	SIE	Sienna*
MCH	Mocha*		
NTO	Night owl*		







4 Laminate Color Selection (Stand Up Surface)

ALB	Alabaster	SHD	Shadow
BBL	Bridal Blanco	SLG	Slate Grey
DWH	Designer White	TAU	Taupe
DOV	Dove Grey		

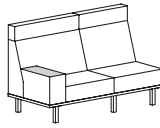
- 5 See a selection of graded in fabric manufacturers and patterns on pages 12-20. Contact Customer Service for additional fabric options.

Specifications

- Wood species - Cherry, Maple or Walnut.
- Seat has synthetic sheet webbing with cross strap reinforcement, 4 ¼" high density polyurethane foam.
- Back has high density polyurethane foam.
- Arms have ¾" thick top and ¼" thick side high density polyurethane foam.
- Plywood construction with locking tenons, glue and screws.
- Linking bracket included.
- Metal legs are 16 gauge steel tube with metal leveling glides.
- ¾" thick 10" deep laminate stand up surface with coordinating 3mm PVC edge supported by steel columns, 42" surface height.

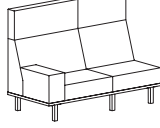
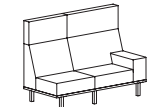
Description	① Model	Specifications	List Price Per Grade																																										
Two Seat High Back  CTL2303WR right	CTL2303WR CTL2303WL · wood cap arm · 10" arm width · 30" individual seat width · 7" high headrest · COM based on single fabric · multiple fabrics, see pages 204-206 for yardage requirements	<table border="1"> <thead> <tr> <th>Dimensions</th> <th>D</th> <th>W</th> <th>H</th> </tr> </thead> <tbody> <tr> <td>Overall</td> <td>32</td> <td>70</td> <td>44 ½</td> </tr> <tr> <td>Seat</td> <td>20</td> <td>60</td> <td>18</td> </tr> <tr> <td>Arm</td> <td></td> <td>10</td> <td>25</td> </tr> </tbody> </table>	Dimensions	D	W	H	Overall	32	70	44 ½	Seat	20	60	18	Arm		10	25	<table border="1"> <tbody> <tr> <td>COM</td> <td>\$3,452</td> </tr> <tr> <td>A</td> <td>\$3,607</td> </tr> <tr> <td>B</td> <td>\$3,812</td> </tr> <tr> <td>COL/C</td> <td>\$4,172</td> </tr> <tr> <td>D</td> <td>\$4,633</td> </tr> <tr> <td>E</td> <td>\$5,095</td> </tr> <tr> <td>F</td> <td>\$5,813</td> </tr> <tr> <td>G</td> <td>\$6,583</td> </tr> <tr> <td>H</td> <td>\$7,404</td> </tr> <tr> <td>I</td> <td>\$8,687</td> </tr> <tr> <td>J</td> <td>\$10,226</td> </tr> <tr> <td>L1</td> <td>\$7,763</td> </tr> <tr> <td>L2</td> <td>\$8,840</td> </tr> </tbody> </table>	COM	\$3,452	A	\$3,607	B	\$3,812	COL/C	\$4,172	D	\$4,633	E	\$5,095	F	\$5,813	G	\$6,583	H	\$7,404	I	\$8,687	J	\$10,226	L1	\$7,763	L2	\$8,840
		Dimensions	D	W	H																																								
Overall	32	70	44 ½																																										
Seat	20	60	18																																										
Arm		10	25																																										
COM	\$3,452																																												
A	\$3,607																																												
B	\$3,812																																												
COL/C	\$4,172																																												
D	\$4,633																																												
E	\$5,095																																												
F	\$5,813																																												
G	\$6,583																																												
H	\$7,404																																												
I	\$8,687																																												
J	\$10,226																																												
L1	\$7,763																																												
L2	\$8,840																																												
 CTL2303WL left	<table border="1"> <thead> <tr> <th>Upholstery</th> <th colspan="3">Shipping</th> </tr> </thead> <tbody> <tr> <td>COM Ydg</td> <td>10 ½</td> <td>Ctn Wt</td> <td>209</td> </tr> <tr> <td>COL Sq Ft</td> <td>242</td> <td>Cu Ft</td> <td>56</td> </tr> </tbody> </table>	Upholstery	Shipping			COM Ydg	10 ½	Ctn Wt	209	COL Sq Ft	242	Cu Ft	56																																
Upholstery	Shipping																																												
COM Ydg	10 ½	Ctn Wt	209																																										
COL Sq Ft	242	Cu Ft	56																																										
Two Seat High Back  CTL2304UR right	CTL2304UR CTL2304UL · upholstered arm · 10" arm width · 30" individual seat width · 7" high headrest · 41 ¾" high stand up surface · COM based on single fabric · multiple fabrics, see pages 204-206 for yardage requirements	<table border="1"> <thead> <tr> <th>Dimensions</th> <th>D</th> <th>W</th> <th>H</th> </tr> </thead> <tbody> <tr> <td>Overall</td> <td>42</td> <td>70</td> <td>44 ½</td> </tr> <tr> <td>Seat</td> <td>20</td> <td>60</td> <td>18</td> </tr> <tr> <td>Arm</td> <td></td> <td>10</td> <td>24 ½</td> </tr> </tbody> </table>	Dimensions	D	W	H	Overall	42	70	44 ½	Seat	20	60	18	Arm		10	24 ½	<table border="1"> <tbody> <tr> <td>COM</td> <td>\$4,548</td> </tr> <tr> <td>A</td> <td>\$4,720</td> </tr> <tr> <td>B</td> <td>\$4,925</td> </tr> <tr> <td>COL/C</td> <td>\$5,284</td> </tr> <tr> <td>D</td> <td>\$5,746</td> </tr> <tr> <td>E</td> <td>\$6,208</td> </tr> <tr> <td>F</td> <td>\$6,926</td> </tr> <tr> <td>G</td> <td>\$7,696</td> </tr> <tr> <td>H</td> <td>\$8,517</td> </tr> <tr> <td>I</td> <td>\$9,799</td> </tr> <tr> <td>J</td> <td>\$11,338</td> </tr> <tr> <td>L1</td> <td>\$8,876</td> </tr> <tr> <td>L2</td> <td>\$9,952</td> </tr> </tbody> </table>	COM	\$4,548	A	\$4,720	B	\$4,925	COL/C	\$5,284	D	\$5,746	E	\$6,208	F	\$6,926	G	\$7,696	H	\$8,517	I	\$9,799	J	\$11,338	L1	\$8,876	L2	\$9,952
		Dimensions	D	W	H																																								
Overall	42	70	44 ½																																										
Seat	20	60	18																																										
Arm		10	24 ½																																										
COM	\$4,548																																												
A	\$4,720																																												
B	\$4,925																																												
COL/C	\$5,284																																												
D	\$5,746																																												
E	\$6,208																																												
F	\$6,926																																												
G	\$7,696																																												
H	\$8,517																																												
I	\$9,799																																												
J	\$11,338																																												
L1	\$8,876																																												
L2	\$9,952																																												
 CTL2304UL left	<table border="1"> <thead> <tr> <th>Upholstery</th> <th colspan="3">Shipping</th> </tr> </thead> <tbody> <tr> <td>COM Ydg</td> <td>10 ½</td> <td>Ctn Wt</td> <td>242</td> </tr> <tr> <td>COL Sq Ft</td> <td>242</td> <td>Cu Ft</td> <td>68</td> </tr> </tbody> </table>	Upholstery	Shipping			COM Ydg	10 ½	Ctn Wt	242	COL Sq Ft	242	Cu Ft	68																																
Upholstery	Shipping																																												
COM Ydg	10 ½	Ctn Wt	242																																										
COL Sq Ft	242	Cu Ft	68																																										
Two Seat High Back  CTL2304WR right	CTL2304WR CTL2304WL · wood cap arm · 10" arm width · 30" individual seat width · 7" high headrest · 41 ¾" high stand up surface · COM based on single fabric · multiple fabrics, see pages 204-206 for yardage requirements	<table border="1"> <thead> <tr> <th>Dimensions</th> <th>D</th> <th>W</th> <th>H</th> </tr> </thead> <tbody> <tr> <td>Overall</td> <td>42</td> <td>70</td> <td>44 ½</td> </tr> <tr> <td>Seat</td> <td>20</td> <td>60</td> <td>18</td> </tr> <tr> <td>Arm</td> <td></td> <td>10</td> <td>25</td> </tr> </tbody> </table>	Dimensions	D	W	H	Overall	42	70	44 ½	Seat	20	60	18	Arm		10	25	<table border="1"> <tbody> <tr> <td>COM</td> <td>\$4,678</td> </tr> <tr> <td>A</td> <td>\$4,853</td> </tr> <tr> <td>B</td> <td>\$5,057</td> </tr> <tr> <td>COL/C</td> <td>\$5,416</td> </tr> <tr> <td>D</td> <td>\$5,878</td> </tr> <tr> <td>E</td> <td>\$6,340</td> </tr> <tr> <td>F</td> <td>\$7,059</td> </tr> <tr> <td>G</td> <td>\$7,828</td> </tr> <tr> <td>H</td> <td>\$8,649</td> </tr> <tr> <td>I</td> <td>\$9,931</td> </tr> <tr> <td>J</td> <td>\$11,471</td> </tr> <tr> <td>L1</td> <td>\$9,008</td> </tr> <tr> <td>L2</td> <td>\$10,085</td> </tr> </tbody> </table>	COM	\$4,678	A	\$4,853	B	\$5,057	COL/C	\$5,416	D	\$5,878	E	\$6,340	F	\$7,059	G	\$7,828	H	\$8,649	I	\$9,931	J	\$11,471	L1	\$9,008	L2	\$10,085
		Dimensions	D	W	H																																								
Overall	42	70	44 ½																																										
Seat	20	60	18																																										
Arm		10	25																																										
COM	\$4,678																																												
A	\$4,853																																												
B	\$5,057																																												
COL/C	\$5,416																																												
D	\$5,878																																												
E	\$6,340																																												
F	\$7,059																																												
G	\$7,828																																												
H	\$8,649																																												
I	\$9,931																																												
J	\$11,471																																												
L1	\$9,008																																												
L2	\$10,085																																												
 CTL2304WL left	<table border="1"> <thead> <tr> <th>Upholstery</th> <th colspan="3">Shipping</th> </tr> </thead> <tbody> <tr> <td>COM Ydg</td> <td>10 ½</td> <td>Ctn Wt</td> <td>247</td> </tr> <tr> <td>COL Sq Ft</td> <td>242</td> <td>Cu Ft</td> <td>68</td> </tr> </tbody> </table>	Upholstery	Shipping			COM Ydg	10 ½	Ctn Wt	247	COL Sq Ft	242	Cu Ft	68																																
Upholstery	Shipping																																												
COM Ydg	10 ½	Ctn Wt	247																																										
COL Sq Ft	242	Cu Ft	68																																										
Two Seat Privacy Back  CTL2305UR right	CTL2305UR CTL2305UL · upholstered arm · 10" arm width · 30" individual seat width · 14" high headrest · COM based on single fabric · multiple fabrics, see pages 204-206 for yardage requirements	<table border="1"> <thead> <tr> <th>Dimensions</th> <th>D</th> <th>W</th> <th>H</th> </tr> </thead> <tbody> <tr> <td>Overall</td> <td>32</td> <td>70</td> <td>51 ½</td> </tr> <tr> <td>Seat</td> <td>20</td> <td>60</td> <td>18</td> </tr> <tr> <td>Arm</td> <td></td> <td>10</td> <td>24 ½</td> </tr> </tbody> </table>	Dimensions	D	W	H	Overall	32	70	51 ½	Seat	20	60	18	Arm		10	24 ½	<table border="1"> <tbody> <tr> <td>COM</td> <td>\$3,584</td> </tr> <tr> <td>A</td> <td>\$3,751</td> </tr> <tr> <td>B</td> <td>\$3,976</td> </tr> <tr> <td>COL/C</td> <td>\$4,370</td> </tr> <tr> <td>D</td> <td>\$4,876</td> </tr> <tr> <td>E</td> <td>\$5,381</td> </tr> <tr> <td>F</td> <td>\$6,168</td> </tr> <tr> <td>G</td> <td>\$7,010</td> </tr> <tr> <td>H</td> <td>\$7,910</td> </tr> <tr> <td>I</td> <td>\$9,315</td> </tr> <tr> <td>J</td> <td>\$11,000</td> </tr> <tr> <td>L1</td> <td>\$8,303</td> </tr> <tr> <td>L2</td> <td>\$9,483</td> </tr> </tbody> </table>	COM	\$3,584	A	\$3,751	B	\$3,976	COL/C	\$4,370	D	\$4,876	E	\$5,381	F	\$6,168	G	\$7,010	H	\$7,910	I	\$9,315	J	\$11,000	L1	\$8,303	L2	\$9,483
		Dimensions	D	W	H																																								
Overall	32	70	51 ½																																										
Seat	20	60	18																																										
Arm		10	24 ½																																										
COM	\$3,584																																												
A	\$3,751																																												
B	\$3,976																																												
COL/C	\$4,370																																												
D	\$4,876																																												
E	\$5,381																																												
F	\$6,168																																												
G	\$7,010																																												
H	\$7,910																																												
I	\$9,315																																												
J	\$11,000																																												
L1	\$8,303																																												
L2	\$9,483																																												
 CTL2305UL left	<table border="1"> <thead> <tr> <th>Upholstery</th> <th colspan="3">Shipping</th> </tr> </thead> <tbody> <tr> <td>COM Ydg</td> <td>11 ½</td> <td>Ctn Wt</td> <td>214</td> </tr> <tr> <td>COL Sq Ft</td> <td>265</td> <td>Cu Ft</td> <td>66</td> </tr> </tbody> </table>	Upholstery	Shipping			COM Ydg	11 ½	Ctn Wt	214	COL Sq Ft	265	Cu Ft	66																																
Upholstery	Shipping																																												
COM Ydg	11 ½	Ctn Wt	214																																										
COL Sq Ft	265	Cu Ft	66																																										

LOUNGE

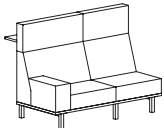
Description	Model	Specifications			List Price Per Grade		
		Dimensions	D	W	H	COM	
Two Seat Privacy Back	CTL2306UR	Overall	42	70	51 ½	COM	\$4,811
	CTL2306UL	Seat	20	60	18	A	\$4,996
	<ul style="list-style-type: none"> · upholstered arm · 10" arm width · 30" individual seat width · 14" high headrest · 41 ¾" high stand up surface · COM based on single fabric · multiple fabrics, see pages 204-206 for yardage requirements 	Arm		10	24 ½	B	\$5,221
		Upholstery		Shipping		COL/C	\$5,614
		COM Ydg	11 ½	Ctn Wt	252	D	\$6,120
		COL Sq Ft	265	Cu Ft	78	E	\$6,626
						F	\$7,412
						G	\$8,256
						H	\$9,154
						I	\$10,559
						J	\$12,246
						L1	\$9,548
						L2	\$10,727

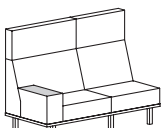
Description	Model	Specifications			List Price Per Grade		
		Dimensions	D	W	H	COM	
Two Seat Privacy Back	CTL2305WR	Overall	32	70	51 ½	COM	\$3,714
	CTL2305WL	Seat	20	60	18	A	\$3,883
	<ul style="list-style-type: none"> · wood cap arm · 10" arm width · 30" individual seat width · 14" high headrest · COM based on single fabric · multiple fabrics, see pages 204-206 for yardage requirements 	Arm		10	25	B	\$4,108
		Upholstery		Shipping		COL/C	\$4,502
		COM Ydg	11 ½	Ctn Wt	219	D	\$5,007
		COL Sq Ft	265	Cu Ft	66	E	\$5,513
						F	\$6,299
						G	\$7,143
						H	\$8,042
						I	\$9,447
						J	\$11,133
						L1	\$8,435
						L2	\$9,615

To Order, Specify:

- Model Number
- Wood Species - Cherry (CH1), Maple (MA1) or Walnut (WA1)
- Wood Finish
- Laminate Color Selection (Stand up Surface)
- Fabric Selection - vendor, pattern and color
 - Seat
 - Back
 - Arm
 - Headrest
- Metal Leg Color - Black Sandtex (BSX), Soft Nickel (SNK) or Stardust Silver (STS)
- Optional Power Center - Flush Mount (EC22) - Black (B) or White (W); \$504 list each, see page 201 for location availability
- Optional Drink Holder (DH) - add \$84 list each
- Optional Tablet Arm - indicate left (TBL) or right arm (TBR); add \$476 list
- Optional Coordinating Wood Grain Laminate Available on Wood Cap Arm - no upcharge. Finishes with an asterisk have a coordinating laminate available.
- Product Options

3 Wood Finish Options:

Cherry			
AUT	Autumn*	EAR	Earthy
BRL	Barley*	LGC	Legacy*
BBN	Bourbon*	PRL	Praline*
BRG	Brighton*	SAF	Saffron*
CLA	Classic*		
Maple			
ALE	Ale*	FLX	Flax▲
BUT	Butterscotch	VEN	Venetian*▲
CIN	Cinnamon*		
Walnut			
AUB	Auburn*	TOF	Toffee*
ESP	Espresso	TRF	Truffle*
MCH	Mocha*	SIE	Sienna*
NTO	Night owl*		

4 Laminate Color Selection (Stand Up Surface)

ALB	Alabaster	SHD	Shadow
BBL	Bridal Blanco	SLG	Slate Grey
DWH	Designer White	TAU	Taupe
DOV	Dove Grey		

- See a selection of graded in fabric manufacturers and patterns on pages 12-20. Contact Customer Service for additional fabric options.

Specifications

- Wood species - Cherry, Maple or Walnut.
- Seat has synthetic sheet webbing with cross strap reinforcement, 4 ¼" high density polyurethane foam.
- Back has high density polyurethane foam.
- Arms have ¾" thick top and ¼" thick side high density polyurethane foam.
- Plywood construction with locking tenons, glue and screws.
- Linking bracket included.
- Metal legs are 16 gauge steel tube with metal leveling glides.
- ¾" thick 10" deep laminate stand up surface with coordinating 3mm PVC edge supported by steel columns, 42" surface height.

Description	① Model	Specifications				List Price Per Grade	
Two Seat Privacy Back	CTL2306WR CTL2306WL <ul style="list-style-type: none"> · wood cap arm · 10" arm width · 30" individual seat width · 14" high headrest · 41 ¾" high stand up surface · COM based on single fabric · multiple fabrics, see pages 204-206 for yardage requirements 	Dimensions		D	W	H	COM \$4,941 A \$5,129 B \$5,353 COL/C \$5,746 D \$6,252 E \$6,758 F \$7,545 G \$8,388 H \$9,287 I \$10,692 J \$12,378 L1 \$9,680 L2 \$10,860
		Overall	42	70	51 ½		
		Seat	20	60	18		
		Arm		10	25		
		Upholstery		Shipping			
		COM Ydg	11 ½	Ctn Wt	257		
		COL Sq Ft	265	Cu Ft	78		
Two Seat Low Back	CTL2201U2 <ul style="list-style-type: none"> · upholstered arms · 5" arm width · 20" individual seat width · COM based on single fabric · multiple fabrics, see pages 204-206 for yardage requirements 	Dimensions		D	W	H	COM \$2,979 A \$3,123 B \$3,318 COL/C \$3,660 D \$4,100 E \$4,540 F \$5,224 G \$5,957 H \$6,738 I \$7,961 J \$9,426 L1 \$7,081 L2 \$8,106
		Overall	32	50	30 ½		
		Seat	20	40	18		
		Arm		5	24 ½		
		Upholstery		Shipping			
		COM Ydg	10	Ctn Wt	105		
		COL Sq Ft	230	Cu Ft	26		
Two Seat Low Back	CTL2201W2 <ul style="list-style-type: none"> · wood cap arms · 5" arm width · 20" individual seat width · COM based on single fabric · multiple fabrics, see pages 204-206 for yardage requirements 	Dimensions		D	W	H	COM \$3,243 A \$3,390 B \$3,585 COL/C \$3,927 D \$4,367 E \$4,807 F \$5,491 G \$6,225 H \$7,006 I \$8,228 J \$9,694 L1 \$7,348 L2 \$8,374
		Overall	32	50	30 ½		
		Seat	20	40▲	18		
		Arm		5	25		
		Upholstery		Shipping			
		COM Ydg	10	Ctn Wt	115		
		COL Sq Ft	230	Cu Ft	26		
Two Seat Low Back	CTL2301U2 <ul style="list-style-type: none"> · upholstered arms · 10" arm width · 30" individual seat width · COM based on single fabric · multiple fabrics, see pages 204-206 for yardage requirements 	Dimensions		D	W	H	COM \$3,246 A \$3,393 B \$3,589 COL/C \$3,931 D \$4,371 E \$4,811 F \$5,495 G \$6,228 H \$7,009 I \$8,231 J \$9,697 L1 \$7,352 L2 \$8,377
		Overall	32	80	30 ½		
		Seat	20	60	18		
		Arm		10	24 ½		
		Upholstery		Shipping			
		COM Ydg	10	Ctn Wt	221		
		COL Sq Ft	230	Cu Ft	41		

LOUNGE

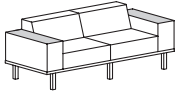
Description	1 Model	Specifications			List Price Per Grade		
		Dimensions	D	W	H	COM	
Two Seat Low Back 	CTL2301W2 • wood cap arms • 10" arm width • 30" individual seat width • COM based on single fabric • multiple fabrics, see pages 204-206 for yardage requirements	Overall	32	80	30 1/2	COM	\$3,510
		Seat	20	60	18	A	\$3,661
		Arm		10	25	B	\$3,856
		Upholstery		Shipping		COL/C	\$4,198
		COM Ydg	10	Ctn Wt	231	D	\$4,638
		COL Sq Ft	230	Cu Ft	41	E	\$5,078
						F	\$5,762
						G	\$6,495
						H	\$7,277
						I	\$8,498
						J	\$9,965
						L1	\$7,619
						L2	\$8,645

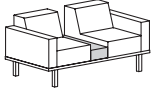
Description	1 Model	Specifications			List Price Per Grade		
		Dimensions	D	W	H	COM	
Two Seat Low Back 	CTL2201U2CC • upholstered arms • 5" arm width • 20" individual seat width • 10" wide center console • COM based on single fabric • multiple fabrics, see pages 204-206 for yardage requirements	Overall	32	60	30 1/2	COM	\$3,477
		Seat	20	40	18	A	\$3,628
		Arm		5	24 1/2	B	\$3,824
		Upholstery		Shipping		COL/C	\$4,166
		COM Ydg	10	Ctn Wt	118	D	\$4,605
		COL Sq Ft	230	Cu Ft	31	E	\$5,045
						F	\$5,729
						G	\$6,462
						H	\$7,244
						I	\$8,466
						J	\$9,931
						L1	\$7,586
						L2	\$8,612

To Order, Specify:

- 1 Model Number
- 2 Wood Species - Cherry (CH1), Maple (MA1) or Walnut (WA1)
- 3 Wood Finish
- 4 Laminate Color Selection (Stand up Surface)
- 5 Fabric Selection - vendor, pattern and color
 - A. Seat
 - B. Back
 - C. Arm
 - D. Headrest
- 6 Metal Leg Color - Black Sandtex (BSX), Soft Nickel (SNK) or Stardust Silver (STS)
- 7 Optional Wood Back Rail - available on any unit with two arms, specify and add \$136 list
- 8 Optional Power Center - Flush Mount (EC22) - Black (B) or White (W); \$504 list each, see page 201 for location availability
- 9 Optional Drink Holder(s) (DH) - add \$84 list each, indicate left or right arm; add \$168 list for end table
- 10 Optional Tablet Arm - indicate left (TBL) or right arm (TBR); add \$476 list
- 11 Optional Coordinating Wood Grain Laminate Available on Wood Cap Arm or Table Top - no upcharge. Finishes with an asterisk have a coordinating laminate available
- 12 Product Options

3 Wood Finish Options:

Cherry			
AUT	Autumn*	EAR	Earthy
BRL	Barley*	LGC	Legacy*
BBN	Bourbon*	PRL	Praline*
BRG	Brighton*	SAF	Saffron*
CLA	Classic*		
Maple			
ALE	Ale*	FLX	Flax▲
BUT	Butterscotch	VEN	Venetian*▲
CIN	Cinnamon*		
Walnut			
AUB	Auburn*	TOF	Toffee*
ESP	Espresso	TRF	Truffle*
MCH	Mocha*	SIE	Sienna*
NTO	Night owl*		

4 Laminate Color Selection (Stand Up Surface)

ALB	Alabaster	SHD	Shadow
BBL	Bridal Bianco	SLG	Slate Grey
DWH	Designer White	TAU	Taupe
DOV	Dove Grey		

- 5 See a selection of graded in fabric manufacturers and patterns on pages 12-20. Contact Customer Service for additional fabric options.

Specifications

- Wood species - Cherry, Maple or Walnut.
- Seat has synthetic sheet webbing with cross strap reinforcement, 4 1/4" high density polyurethane foam.
- Back has high density polyurethane foam.
- Arms have 3/4" thick top and 1/4" thick side high density polyurethane foam.
- Plywood construction with locking tenons, glue and screws.
- Linking bracket included.
- Metal legs are 16 gauge steel tube with metal leveling glides.
- 3/4" thick 10" deep laminate stand up surface with coordinating 3mm PVC edge supported by steel columns, 42" surface height.

When ordering Quickship products, place a "Q" in front of model number. Example: QGT4901D

NOW!
Need it.
JSI Quickship

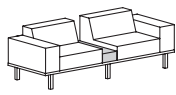
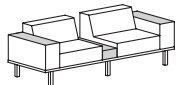
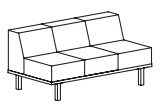
Description	① Model	Specifications	List Price Per Grade																
Two Seat Low Back 	CTL2201W2CC · wood cap arms · 5" arm width · 20" individual seat width · 10" wide center console · COM based on single fabric · multiple fabrics, see pages 204-206 for yardage requirements	<table border="1"> <thead> <tr> <th>Dimensions</th> <th>D</th> <th>W</th> <th>H</th> </tr> </thead> <tbody> <tr> <td>Overall</td> <td>32</td> <td>60</td> <td>30½</td> </tr> <tr> <td>Seat</td> <td>20</td> <td>40</td> <td>18</td> </tr> <tr> <td>Arm</td> <td></td> <td>5</td> <td>25</td> </tr> </tbody> </table>	Dimensions	D	W	H	Overall	32	60	30½	Seat	20	40	18	Arm		5	25	COM \$3,740 A \$3,894 B \$4,090 COL/C \$4,431 D \$4,871 E \$5,311 F \$5,996 G \$6,729 H \$7,510 I \$8,732 J \$10,198 L1 \$7,852 L2 \$8,878
		Dimensions	D	W	H														
Overall	32	60	30½																
Seat	20	40	18																
Arm		5	25																
<table border="1"> <thead> <tr> <th>Upholstery</th> <th colspan="3">Shipping</th> </tr> </thead> <tbody> <tr> <td>COM Ydg</td> <td>10</td> <td>Ctn Wt</td> <td>123</td> </tr> <tr> <td>COL Sq Ft</td> <td>230</td> <td>Cu Ft</td> <td>31</td> </tr> </tbody> </table>	Upholstery	Shipping			COM Ydg	10	Ctn Wt	123	COL Sq Ft	230	Cu Ft	31							
Upholstery	Shipping																		
COM Ydg	10	Ctn Wt	123																
COL Sq Ft	230	Cu Ft	31																
Two Seat Low Back 	CTL2301U2CC · upholstered arms · 10" arm width · 30" individual seat width · 10" wide center console · COM based on single fabric · multiple fabrics, see pages 204-206 for yardage requirements	<table border="1"> <thead> <tr> <th>Dimensions</th> <th>D</th> <th>W</th> <th>H</th> </tr> </thead> <tbody> <tr> <td>Overall</td> <td>32</td> <td>90</td> <td>30½</td> </tr> <tr> <td>Seat</td> <td>20</td> <td>60</td> <td>18</td> </tr> <tr> <td>Arm</td> <td></td> <td>10</td> <td>24½</td> </tr> </tbody> </table>	Dimensions	D	W	H	Overall	32	90	30½	Seat	20	60	18	Arm		10	24½	COM \$3,743 A \$3,897 B \$4,093 COL/C \$4,435 D \$4,875 E \$5,315 F \$5,999 G \$6,732 H \$7,513 I \$8,735 J \$10,201 L1 \$7,856 L2 \$8,881
		Dimensions	D	W	H														
Overall	32	90	30½																
Seat	20	60	18																
Arm		10	24½																
<table border="1"> <thead> <tr> <th>Upholstery</th> <th colspan="3">Shipping</th> </tr> </thead> <tbody> <tr> <td>COM Ydg</td> <td>10</td> <td>Ctn Wt</td> <td>237</td> </tr> <tr> <td>COL Sq Ft</td> <td>230</td> <td>Cu Ft</td> <td>46</td> </tr> </tbody> </table>	Upholstery	Shipping			COM Ydg	10	Ctn Wt	237	COL Sq Ft	230	Cu Ft	46							
Upholstery	Shipping																		
COM Ydg	10	Ctn Wt	237																
COL Sq Ft	230	Cu Ft	46																
Two Seat Low Back 	CTL2301W2CC · wood cap arms · 10" arm width · 30" individual seat width · 10" wide center console · COM based on single fabric · multiple fabrics, see pages 204-206 for yardage requirements	<table border="1"> <thead> <tr> <th>Dimensions</th> <th>D</th> <th>W</th> <th>H</th> </tr> </thead> <tbody> <tr> <td>Overall</td> <td>32</td> <td>90</td> <td>30½</td> </tr> <tr> <td>Seat</td> <td>20</td> <td>60</td> <td>18</td> </tr> <tr> <td>Arm</td> <td></td> <td>10</td> <td>25</td> </tr> </tbody> </table>	Dimensions	D	W	H	Overall	32	90	30½	Seat	20	60	18	Arm		10	25	COM \$4,007 A \$4,166 B \$4,361 COL/C \$4,703 D \$5,143 E \$5,583 F \$6,267 G \$7,001 H \$7,782 I \$9,004 J \$10,470 L1 \$8,124 L2 \$9,150
		Dimensions	D	W	H														
Overall	32	90	30½																
Seat	20	60	18																
Arm		10	25																
<table border="1"> <thead> <tr> <th>Upholstery</th> <th colspan="3">Shipping</th> </tr> </thead> <tbody> <tr> <td>COM Ydg</td> <td>10</td> <td>Ctn Wt</td> <td>247</td> </tr> <tr> <td>COL Sq Ft</td> <td>230</td> <td>Cu Ft</td> <td>46</td> </tr> </tbody> </table>	Upholstery	Shipping			COM Ydg	10	Ctn Wt	247	COL Sq Ft	230	Cu Ft	46							
Upholstery	Shipping																		
COM Ydg	10	Ctn Wt	247																
COL Sq Ft	230	Cu Ft	46																
Three Seat Low Back 	CTL3201 · armless · 20" individual seat width · COM based on single fabric · multiple fabrics, see pages 204-206 for yardage requirements	<table border="1"> <thead> <tr> <th>Dimensions</th> <th>D</th> <th>W</th> <th>H</th> </tr> </thead> <tbody> <tr> <td>Overall</td> <td>32</td> <td>60</td> <td>30½</td> </tr> <tr> <td>Seat</td> <td>20</td> <td>60</td> <td>18</td> </tr> </tbody> </table>	Dimensions	D	W	H	Overall	32	60	30½	Seat	20	60	18	COM \$3,208 A \$3,360 B \$3,565 COL/C \$3,924 D \$4,386 E \$4,848 F \$5,567 G \$6,336 H \$7,157 I \$8,439 J \$9,979 L1 \$7,516 L2 \$8,593				
		Dimensions	D	W	H														
Overall	32	60	30½																
Seat	20	60	18																
<table border="1"> <thead> <tr> <th>Upholstery</th> <th colspan="3">Shipping</th> </tr> </thead> <tbody> <tr> <td>COM Ydg</td> <td>10½</td> <td>Ctn Wt</td> <td>141</td> </tr> <tr> <td>COL Sq Ft</td> <td>242</td> <td>Cu Ft</td> <td>31</td> </tr> </tbody> </table>	Upholstery	Shipping			COM Ydg	10½	Ctn Wt	141	COL Sq Ft	242	Cu Ft	31							
Upholstery	Shipping																		
COM Ydg	10½	Ctn Wt	141																
COL Sq Ft	242	Cu Ft	31																

LOUNGE

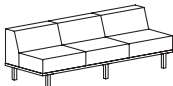
Description	Model	Specifications				List Price Per Grade	
		Dimensions	D	W	H	COM	
Three Seat Low Back 	CTL3301 · armless · 30" individual seat width · COM based on single fabric · multiple fabrics, see pages 204-206 for yardage requirements	Overall	32	90	30½	A	\$3,493
		Seat	20	90	18	B	\$3,854
		Upholstery		Shipping		COL/C	\$4,213
		COM Ydg	10½	Ctn Wt	206	D	\$4,675
		COL Sq Ft	242	Cu Ft	46	E	\$5,137
						F	\$5,855
						G	\$6,625
						H	\$7,446
						I	\$8,728
						J	\$10,267
				L1	\$7,805		
				L2	\$8,881		

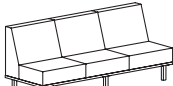
Description	Model	Specifications				List Price Per Grade	
		Dimensions	D	W	H	COM	
Three Seat Mid Back 	CTL3302 · armless · 30" individual seat width · COM based on single fabric · multiple fabrics, see pages 204-206 for yardage requirements	Overall	32	90	37½	A	\$3,906
		Seat	20	90	18	B	\$4,296
		Upholstery		Shipping		COL/C	\$4,680
		COM Ydg	11 ¼	Ctn Wt	211	D	\$5,176
		COL Sq Ft	259	Cu Ft	58	E	\$5,670
						F	\$6,440
						G	\$7,264
						H	\$8,144
						I	\$9,519
						J	\$11,167
				L1	\$8,529		
				L2	\$9,683		

To Order, Specify:

- 1 Model Number
- 2 Wood Species - Cherry (CH1), Maple (MA1) or Walnut (WA1)
- 3 Wood Finish
- 4 Fabric Selection - vendor, pattern and color
 - A. Seat
 - B. Back
 - C. Arm
 - D. Headrest
- 5 Metal Leg Color - Black Sandtex (BSX), Soft Nickel (SNK) or Stardust Silver (STS)
- 6 Optional Wood Back Rail - available on any unit with two arms, specify and add \$136 list
- 7 Optional Power Center - Flush Mount (EC22) - Black (B) or White (W); \$504 list each, see page 201 for location availability
- 8 Optional Drink Holder(s) (DH) - add \$84 list each, indicate left or right arm; add \$168 list for end table
- 9 Optional Tablet Arm - indicate left (TBL) or right arm (TBR); add \$476 list
- ▲ 10 Optional Coordinating Wood Grain Laminate Available on Wood Cap Arm or Table Top - no upcharge. Finishes with an asterisk have a coordinating laminate available
- 11 Product Options

3 Wood Finish Options:

- Cherry**
- | | |
|---------------|--------------|
| AUT Autumn* | EAR Earthy |
| BRL Barley* | LGC Legacy* |
| BBN Bourbon* | PRL Praline* |
| BRG Brighton* | SAF Saffron* |
| CLA Classic* | |
- Maple**
- | | |
|------------------|-----------------|
| ALE Ale* | FLX Flax ▲ |
| BUT Butterscotch | VEN Venetian* ▲ |
| CIN Cinnamon* | |
- Walnut**
- | | |
|----------------|--------------|
| AUB Auburn* | TOF Toffee* |
| ESP Espresso | TRF Truffle* |
| MCH Mocha* | SIE Sienna* |
| NTO Night owl* | |

- 4 See a selection of graded in fabric manufacturers and patterns on pages 12-20. Contact Customer Service for additional fabric options.

Specifications

- Wood species - Cherry, Maple or Walnut.
- Seat has synthetic sheet webbing with cross strap reinforcement, 4 ¼" high density polyurethane foam.
- Back has high density polyurethane foam.
- Arms have ¾" thick top and ¼" thick side high density polyurethane foam.
- Plywood construction with locking tenons, glue and screws.
- Linking bracket included.
- Metal legs are 16 gauge steel tube with metal leveling glides.

When ordering Quickship products, place a "Q" in front of model number.
Example: QGT4901D

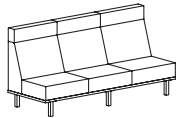
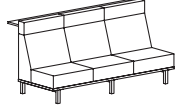
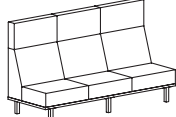
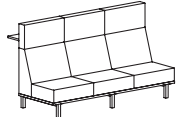

Description	① Model	Specifications				List Price Per Grade	
Three Seat High Back 	CTL3303 · armless · 30" individual seat width · 7" high headrest · COM based on single fabric · multiple fabrics, see pages 204-206 for yardage requirements	Dimensions		D	W	H	COM \$4,300 A \$4,498 B \$4,761 COL/C \$5,223 D \$5,817 E \$6,411 F \$7,335 G \$8,324 H \$9,379 I \$11,029 J \$13,008 L1 \$9,841 L2 \$11,226
		Overall	32	90	44 ½		
		Seat	20	90	18		
		Upholstery		Shipping			
		COM Ydg	13 ½	Ctn Wt	226		
		COL Sq Ft	311	Cu Ft	71		
Three Seat High Back 	CTL3304 · armless · stand up surface · 30" individual seat width · 7" high headrest · 41 ¾" high stand up surface · COM based on single fabric · multiple fabrics, see pages 204-206 for yardage requirements	Dimensions		D	W	H	COM \$5,551 A \$5,767 B \$6,031 COL/C \$6,493 D \$7,087 E \$7,680 F \$8,604 G \$9,593 H \$10,649 I \$12,298 J \$14,277 L1 \$11,111 L2 \$12,495
		Overall	42	90	44 ½		
		Seat	20	90	18		
		Upholstery		Shipping			
		COM Ydg	13 ½	Ctn Wt	277		
		COL Sq Ft	311	Cu Ft	83		
Three Seat Privacy Back 	CTL3305 · armless · 30" individual seat width · 14" high headrest · COM based on single fabric · multiple fabrics, see pages 204-206 for yardage requirements	Dimensions		D	W	H	COM \$4,694 A \$4,912 B \$5,205 COL/C \$5,719 D \$6,378 E \$7,038 F \$8,064 G \$9,164 H \$10,337 I \$12,169 J \$14,368 L1 \$10,849 L2 \$12,388
		Overall	32	90	51 ½		
		Seat	20	90	18		
		Upholstery		Shipping			
		COM Ydg	15	Ctn Wt	232		
		COL Sq Ft	345	Cu Ft	84		
Three Seat Privacy Back 	CTL3306 · armless · 30" individual seat width · 14" high headrest · 41 ¾" high stand up surface · COM based on single fabric · multiple fabrics, see pages 204-206 for yardage requirements	Dimensions		D	W	H	COM \$5,945 A \$6,182 B \$6,475 COL/C \$6,988 D \$7,648 E \$8,307 F \$9,333 G \$10,433 H \$11,606 I \$13,438 J \$15,637 L1 \$12,119 L2 \$13,657
		Overall	42	90	51 ½		
		Seat	20	90	18		
		Upholstery		Shipping			
		COM Ydg	15	Ctn Wt	283		
		COL Sq Ft	345	Cu Ft	96		

LOUNGE

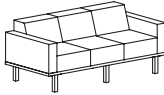
Description	1 Model	Specifications			List Price Per Grade		
		Dimensions	D	W	H	COM	
Three Seat Low Back 	CTL3201U2 • upholstered arms • 5" arm width • 20" individual seat width • COM based on single fabric • multiple fabrics, see pages 204-206 for yardage requirements	Overall	32	70	30½	COM	\$4,031
		Seat	20	60	18	COL/C	\$4,950
		Arm		5	24½	D	\$5,544
		Upholstery		Shipping		E	\$6,138
		COM Ydg	13½	Ctn Wt	175	F	\$7,062
		COL Sq Ft	311	Cu Ft	36	G	\$8,051
						H	\$9,107
						I	\$10,756
						J	\$12,735
						L1	\$9,568
						L2	\$10,953

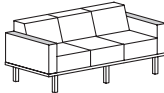
Description	1 Model	Specifications			List Price Per Grade		
		Dimensions	D	W	H	COM	
Three Seat Low Back 	CTL3201W2 • wood cap arms • 5" arm width • 20" individual seat width • COM based on single fabric • multiple fabrics, see pages 204-206 for yardage requirements	Overall	32	70	30½	COM	\$4,295
		Seat	20	60	18	COL/C	\$5,218
		Arm		5	25	D	\$5,812
		Upholstery		Shipping		E	\$6,405
		COM Ydg	13½	Ctn Wt	175	F	\$7,329
		COL Sq Ft	311	Cu Ft	36	G	\$8,319
						H	\$9,374
						I	\$11,023
						J	\$13,003
						L1	\$9,836
						L2	\$11,221

To Order, Specify:

- 1 Model Number
- 2 Wood Species - Cherry (CH1), Maple (MA1) or Walnut (WA1)
- 3 Wood Finish
- 4 Laminate Color Selection (Stand up Surface)
- 5 Fabric Selection - vendor, pattern and color
 - A. Seat
 - B. Back
 - C. Arm
 - D. Headrest
- 6 Metal Leg Color - Black Sandtex (BSX), Soft Nickel (SNK) or Stardust Silver (STS)
- 7 Optional Wood Back Rail - available on any unit with two arms, specify and add \$136 list
- 8 Optional Power Center - Flush Mount (EC22) - Black (B) or White (W); \$504 list each, see page 201 for location availability
- 9 Optional Drink Holder(s) (DH) - add \$84 list each, indicate left or right arm
- 10 Optional Tablet Arm - indicate left (TBL) or right arm (TBR); add \$476 list
- 11 Optional Coordinating Wood Grain Laminate
Available - no upcharge. Finishes with an asterisk have a coordinating laminate available
- 12 Product Options

3 Wood Finish Options:

- Cherry**
- | | |
|---------------|--------------|
| AUT Autumn* | EAR Earthy |
| BRL Barley* | LGC Legacy* |
| BBN Bourbon* | PRL Praline* |
| BRG Brighton* | SAF Saffron* |
| CLA Classic* | |
- Maple**
- | | |
|------------------|----------------|
| ALE Ale* | FLX Flax▲ |
| BUT Butterscotch | VEN Venetian*▲ |
| CIN Cinnamon* | |
- Walnut**
- | | |
|----------------|--------------|
| AUB Auburn* | TOF Toffee* |
| ESP Espresso | TRF Truffle* |
| MCH Mocha* | SIE Sienna* |
| NTO Night owl* | |

4 Laminate Color Selection (Stand Up Surface)

- | | |
|--------------------|----------------|
| ALB Alabaster | SHD Shadow |
| BBL Bridal Blanco | SLG Slate Grey |
| DWH Designer White | TAU Taupe |
| DOV Dove Grey | |





- 5 See a selection of graded in fabric manufacturers and patterns on pages 12-20. Contact Customer Service for additional fabric options.

Specifications







- Wood species - Cherry, Maple or Walnut.
- Seat has synthetic sheet webbing with cross strap reinforcement, 4 ¼" high density polyurethane foam.
- Back has high density polyurethane foam.
- Arms have ¾" thick top and ¼" thick side high density polyurethane foam.
- Plywood construction with locking tenons, glue and screws.
- Linking bracket included.
- Metal legs are 16 gauge steel tube with metal leveling glides.
- ¾" thick 10" deep laminate stand up surface with coordinating 3mm PVC edge supported by steel columns, 42" surface height.

When ordering Quickship products, place a "Q" in front of model number.
Example: QGT4901D

NOW!
Need it.
JSI Quickship

Description	① Model	Specifications	List Price Per Grade																																										
Four Seat Low Back 	CTL4201 · armless · 20" individual seat width · COM based on single fabric · multiple fabrics, see pages 204-206 for yardage requirements	<table border="1"> <thead> <tr> <th>Dimensions</th> <th>D</th> <th>W</th> <th>H</th> </tr> </thead> <tbody> <tr> <td>Overall</td> <td>32</td> <td>80</td> <td>30½</td> </tr> <tr> <td>Seat</td> <td>20</td> <td>80</td> <td>18</td> </tr> </tbody> </table>	Dimensions	D	W	H	Overall	32	80	30½	Seat	20	80	18	<table border="1"> <tbody> <tr><td>COM</td><td>\$4,270</td></tr> <tr><td>A</td><td>\$4,471</td></tr> <tr><td>B</td><td>\$4,745</td></tr> <tr><td>COL/C</td><td>\$5,224</td></tr> <tr><td>D</td><td>\$5,840</td></tr> <tr><td>E</td><td>\$6,456</td></tr> <tr><td>F</td><td>\$7,413</td></tr> <tr><td>G</td><td>\$8,439</td></tr> <tr><td>H</td><td>\$9,534</td></tr> <tr><td>I</td><td>\$11,245</td></tr> <tr><td>J</td><td>\$13,297</td></tr> <tr><td>L1</td><td>\$10,013</td></tr> <tr><td>L2</td><td>\$11,450</td></tr> </tbody> </table>	COM	\$4,270	A	\$4,471	B	\$4,745	COL/C	\$5,224	D	\$5,840	E	\$6,456	F	\$7,413	G	\$8,439	H	\$9,534	I	\$11,245	J	\$13,297	L1	\$10,013	L2	\$11,450				
		Dimensions	D	W	H																																								
Overall	32	80	30½																																										
Seat	20	80	18																																										
COM	\$4,270																																												
A	\$4,471																																												
B	\$4,745																																												
COL/C	\$5,224																																												
D	\$5,840																																												
E	\$6,456																																												
F	\$7,413																																												
G	\$8,439																																												
H	\$9,534																																												
I	\$11,245																																												
J	\$13,297																																												
L1	\$10,013																																												
L2	\$11,450																																												
<table border="1"> <thead> <tr> <th>Upholstery</th> <th colspan="3">Shipping</th> </tr> </thead> <tbody> <tr> <td>COM Ydg</td> <td>14</td> <td>Ctn Wt</td> <td>194</td> </tr> <tr> <td>COL Sq Ft</td> <td>322</td> <td>Cu Ft</td> <td>41</td> </tr> </tbody> </table>	Upholstery	Shipping			COM Ydg	14	Ctn Wt	194	COL Sq Ft	322	Cu Ft	41																																	
Upholstery	Shipping																																												
COM Ydg	14	Ctn Wt	194																																										
COL Sq Ft	322	Cu Ft	41																																										
Four Seat Low Back 	CTL4201U2 · upholstered arms · 5" arm width · 20" individual seat width · COM based on single fabric · multiple fabrics, see pages 204-206 for yardage requirements	<table border="1"> <thead> <tr> <th>Dimensions</th> <th>D</th> <th>W</th> <th>H</th> </tr> </thead> <tbody> <tr> <td>Overall</td> <td>32</td> <td>90</td> <td>30½</td> </tr> <tr> <td>Seat</td> <td>20</td> <td>80</td> <td>18</td> </tr> <tr> <td>Arm</td> <td></td> <td>5</td> <td>24½</td> </tr> </tbody> </table>	Dimensions	D	W	H	Overall	32	90	30½	Seat	20	80	18	Arm		5	24½	<table border="1"> <tbody> <tr><td>COM</td><td>\$5,105</td></tr> <tr><td>A</td><td>\$5,348</td></tr> <tr><td>B</td><td>\$5,681</td></tr> <tr><td>COL/C</td><td>\$6,263</td></tr> <tr><td>D</td><td>\$7,010</td></tr> <tr><td>E</td><td>\$7,758</td></tr> <tr><td>F</td><td>\$8,920</td></tr> <tr><td>G</td><td>\$10,167</td></tr> <tr><td>H</td><td>\$11,496</td></tr> <tr><td>I</td><td>\$13,573</td></tr> <tr><td>J</td><td>\$16,064</td></tr> <tr><td>L1</td><td>\$12,078</td></tr> <tr><td>L2</td><td>\$13,821</td></tr> </tbody> </table>	COM	\$5,105	A	\$5,348	B	\$5,681	COL/C	\$6,263	D	\$7,010	E	\$7,758	F	\$8,920	G	\$10,167	H	\$11,496	I	\$13,573	J	\$16,064	L1	\$12,078	L2	\$13,821
		Dimensions	D	W	H																																								
Overall	32	90	30½																																										
Seat	20	80	18																																										
Arm		5	24½																																										
COM	\$5,105																																												
A	\$5,348																																												
B	\$5,681																																												
COL/C	\$6,263																																												
D	\$7,010																																												
E	\$7,758																																												
F	\$8,920																																												
G	\$10,167																																												
H	\$11,496																																												
I	\$13,573																																												
J	\$16,064																																												
L1	\$12,078																																												
L2	\$13,821																																												
<table border="1"> <thead> <tr> <th>Upholstery</th> <th colspan="3">Shipping</th> </tr> </thead> <tbody> <tr> <td>COM Ydg</td> <td>17</td> <td>Ctn Wt</td> <td>206</td> </tr> <tr> <td>COL Sq Ft</td> <td>391</td> <td>Cu Ft</td> <td>46</td> </tr> </tbody> </table>	Upholstery	Shipping			COM Ydg	17	Ctn Wt	206	COL Sq Ft	391	Cu Ft	46																																	
Upholstery	Shipping																																												
COM Ydg	17	Ctn Wt	206																																										
COL Sq Ft	391	Cu Ft	46																																										
Four Seat Low Back 	CTL4201W2 · wood cap arms · 5" arm width · 20" individual seat width · COM based on single fabric · multiple fabrics, see pages 204-206 for yardage requirements	<table border="1"> <thead> <tr> <th>Dimensions</th> <th>D</th> <th>W</th> <th>H</th> </tr> </thead> <tbody> <tr> <td>Overall</td> <td>32</td> <td>90</td> <td>30½</td> </tr> <tr> <td>Seat</td> <td>20</td> <td>80</td> <td>18</td> </tr> <tr> <td>Arm</td> <td></td> <td>5</td> <td>25</td> </tr> </tbody> </table>	Dimensions	D	W	H	Overall	32	90	30½	Seat	20	80	18	Arm		5	25	<table border="1"> <tbody> <tr><td>COM</td><td>\$5,367</td></tr> <tr><td>A</td><td>\$5,615</td></tr> <tr><td>B</td><td>\$5,948</td></tr> <tr><td>COL/C</td><td>\$6,528</td></tr> <tr><td>D</td><td>\$7,276</td></tr> <tr><td>E</td><td>\$8,025</td></tr> <tr><td>F</td><td>\$9,187</td></tr> <tr><td>G</td><td>\$10,433</td></tr> <tr><td>H</td><td>\$11,763</td></tr> <tr><td>I</td><td>\$13,839</td></tr> <tr><td>J</td><td>\$16,331</td></tr> <tr><td>L1</td><td>\$12,344</td></tr> <tr><td>L2</td><td>\$14,087</td></tr> </tbody> </table>	COM	\$5,367	A	\$5,615	B	\$5,948	COL/C	\$6,528	D	\$7,276	E	\$8,025	F	\$9,187	G	\$10,433	H	\$11,763	I	\$13,839	J	\$16,331	L1	\$12,344	L2	\$14,087
		Dimensions	D	W	H																																								
Overall	32	90	30½																																										
Seat	20	80	18																																										
Arm		5	25																																										
COM	\$5,367																																												
A	\$5,615																																												
B	\$5,948																																												
COL/C	\$6,528																																												
D	\$7,276																																												
E	\$8,025																																												
F	\$9,187																																												
G	\$10,433																																												
H	\$11,763																																												
I	\$13,839																																												
J	\$16,331																																												
L1	\$12,344																																												
L2	\$14,087																																												
<table border="1"> <thead> <tr> <th>Upholstery</th> <th colspan="3">Shipping</th> </tr> </thead> <tbody> <tr> <td>COM Ydg</td> <td>17</td> <td>Ctn Wt</td> <td>216</td> </tr> <tr> <td>COL Sq Ft</td> <td>391</td> <td>Cu Ft</td> <td>46</td> </tr> </tbody> </table>	Upholstery	Shipping			COM Ydg	17	Ctn Wt	216	COL Sq Ft	391	Cu Ft	46																																	
Upholstery	Shipping																																												
COM Ydg	17	Ctn Wt	216																																										
COL Sq Ft	391	Cu Ft	46																																										
Corner Seat Low Back 	CTC20S1UC CTC20S1UR CTC20S1UL · armless · 20" seat width · COM based on single fabric · multiple fabrics, see pages 204-206 for yardage requirements	<table border="1"> <thead> <tr> <th>Dimensions</th> <th>D</th> <th>W</th> <th>H</th> </tr> </thead> <tbody> <tr> <td>Overall</td> <td>32</td> <td>32</td> <td>30½</td> </tr> <tr> <td>Seat</td> <td>20</td> <td>20</td> <td>18</td> </tr> </tbody> </table>	Dimensions	D	W	H	Overall	32	32	30½	Seat	20	20	18	<table border="1"> <tbody> <tr><td>COM</td><td>\$2,283</td></tr> <tr><td>A</td><td>\$2,357</td></tr> <tr><td>B</td><td>\$2,435</td></tr> <tr><td>COL/C</td><td>\$2,572</td></tr> <tr><td>D</td><td>\$2,748</td></tr> <tr><td>E</td><td>\$2,924</td></tr> <tr><td>F</td><td>\$3,198</td></tr> <tr><td>G</td><td>\$3,491</td></tr> <tr><td>H</td><td>\$3,804</td></tr> <tr><td>I</td><td>\$4,292</td></tr> <tr><td>J</td><td>\$4,879</td></tr> <tr><td>L1</td><td>\$3,940</td></tr> <tr><td>L2</td><td>\$4,351</td></tr> </tbody> </table>	COM	\$2,283	A	\$2,357	B	\$2,435	COL/C	\$2,572	D	\$2,748	E	\$2,924	F	\$3,198	G	\$3,491	H	\$3,804	I	\$4,292	J	\$4,879	L1	\$3,940	L2	\$4,351				
		Dimensions	D	W	H																																								
Overall	32	32	30½																																										
Seat	20	20	18																																										
COM	\$2,283																																												
A	\$2,357																																												
B	\$2,435																																												
COL/C	\$2,572																																												
D	\$2,748																																												
E	\$2,924																																												
F	\$3,198																																												
G	\$3,491																																												
H	\$3,804																																												
I	\$4,292																																												
J	\$4,879																																												
L1	\$3,940																																												
L2	\$4,351																																												
<table border="1"> <thead> <tr> <th>Upholstery</th> <th colspan="3">Shipping</th> </tr> </thead> <tbody> <tr> <td>COM Ydg</td> <td>4</td> <td>Ctn Wt</td> <td>90</td> </tr> <tr> <td>COL Sq Ft</td> <td>92</td> <td>Cu Ft</td> <td>17</td> </tr> </tbody> </table>	Upholstery	Shipping			COM Ydg	4	Ctn Wt	90	COL Sq Ft	92	Cu Ft	17																																	
Upholstery	Shipping																																												
COM Ydg	4	Ctn Wt	90																																										
COL Sq Ft	92	Cu Ft	17																																										

LOUNGE

Description	Model	Specifications	List Price Per Grade																																																		
Corner Seat Mid Back  CTC20S2UC center  CTC20S2UR right  CTC20S2UL left	CTC20S2UC CTC20S2UR CTC20S2UL • armless • 20" seat width • COM based on single fabric • multiple fabrics, see pages 204-206 for yardage requirements	<table border="1"> <thead> <tr> <th>Dimensions</th> <th>D</th> <th>W</th> <th>H</th> </tr> </thead> <tbody> <tr> <td>Overall</td> <td>32</td> <td>32</td> <td>37 1/2</td> </tr> <tr> <td>Seat</td> <td>20</td> <td>20</td> <td>18</td> </tr> <tr> <th colspan="2">Upholstery</th> <th colspan="2">Shipping</th> </tr> <tr> <td>COM Ydg</td> <td>4 1/2</td> <td>Ctn Wt</td> <td>95</td> </tr> <tr> <td>COL Sq Ft</td> <td>104</td> <td>Cu Ft</td> <td>22</td> </tr> </tbody> </table>	Dimensions	D	W	H	Overall	32	32	37 1/2	Seat	20	20	18	Upholstery		Shipping		COM Ydg	4 1/2	Ctn Wt	95	COL Sq Ft	104	Cu Ft	22	<table border="1"> <tbody> <tr><td>COM</td><td>\$2,362</td></tr> <tr><td>A</td><td>\$2,442</td></tr> <tr><td>B</td><td>\$2,530</td></tr> <tr><td>COL/C</td><td>\$2,684</td></tr> <tr><td>D</td><td>\$2,882</td></tr> <tr><td>E</td><td>\$3,080</td></tr> <tr><td>F</td><td>\$3,388</td></tr> <tr><td>G</td><td>\$3,717</td></tr> <tr><td>H</td><td>\$4,069</td></tr> <tr><td>I</td><td>\$4,619</td></tr> <tr><td>J</td><td>\$5,279</td></tr> <tr><td>L1</td><td>\$4,224</td></tr> <tr><td>L2</td><td>\$4,685</td></tr> </tbody> </table>	COM	\$2,362	A	\$2,442	B	\$2,530	COL/C	\$2,684	D	\$2,882	E	\$3,080	F	\$3,388	G	\$3,717	H	\$4,069	I	\$4,619	J	\$5,279	L1	\$4,224	L2	\$4,685
		Dimensions	D	W	H																																																
Overall	32	32	37 1/2																																																		
Seat	20	20	18																																																		
Upholstery		Shipping																																																			
COM Ydg	4 1/2	Ctn Wt	95																																																		
COL Sq Ft	104	Cu Ft	22																																																		
COM	\$2,362																																																				
A	\$2,442																																																				
B	\$2,530																																																				
COL/C	\$2,684																																																				
D	\$2,882																																																				
E	\$3,080																																																				
F	\$3,388																																																				
G	\$3,717																																																				
H	\$4,069																																																				
I	\$4,619																																																				
J	\$5,279																																																				
L1	\$4,224																																																				
L2	\$4,685																																																				
Corner Seat High Back  CTC20S3UC center  CTC20S3UR right  CTC20S3UL left	CTC20S3UC CTC20S3UR CTC20S3UL • armless • 20" seat width • 7" high headrest • COM based on single fabric • multiple fabrics, see pages 204-206 for yardage requirements	<table border="1"> <thead> <tr> <th>Dimensions</th> <th>D</th> <th>W</th> <th>H</th> </tr> </thead> <tbody> <tr> <td>Overall</td> <td>32</td> <td>32</td> <td>44 1/2</td> </tr> <tr> <td>Seat</td> <td>20</td> <td>20</td> <td>18</td> </tr> <tr> <th colspan="2">Upholstery</th> <th colspan="2">Shipping</th> </tr> <tr> <td>COM Ydg</td> <td>6 1/4</td> <td>Ctn Wt</td> <td>115</td> </tr> <tr> <td>COL Sq Ft</td> <td>144</td> <td>Cu Ft</td> <td>26</td> </tr> </tbody> </table>	Dimensions	D	W	H	Overall	32	32	44 1/2	Seat	20	20	18	Upholstery		Shipping		COM Ydg	6 1/4	Ctn Wt	115	COL Sq Ft	144	Cu Ft	26	<table border="1"> <tbody> <tr><td>COM</td><td>\$2,441</td></tr> <tr><td>A</td><td>\$2,539</td></tr> <tr><td>B</td><td>\$2,661</td></tr> <tr><td>COL/C</td><td>\$2,875</td></tr> <tr><td>D</td><td>\$3,150</td></tr> <tr><td>E</td><td>\$3,425</td></tr> <tr><td>F</td><td>\$3,853</td></tr> <tr><td>G</td><td>\$4,311</td></tr> <tr><td>H</td><td>\$4,799</td></tr> <tr><td>I</td><td>\$5,562</td></tr> <tr><td>J</td><td>\$6,479</td></tr> <tr><td>L1</td><td>\$5,013</td></tr> <tr><td>L2</td><td>\$5,654</td></tr> </tbody> </table>	COM	\$2,441	A	\$2,539	B	\$2,661	COL/C	\$2,875	D	\$3,150	E	\$3,425	F	\$3,853	G	\$4,311	H	\$4,799	I	\$5,562	J	\$6,479	L1	\$5,013	L2	\$5,654
		Dimensions	D	W	H																																																
Overall	32	32	44 1/2																																																		
Seat	20	20	18																																																		
Upholstery		Shipping																																																			
COM Ydg	6 1/4	Ctn Wt	115																																																		
COL Sq Ft	144	Cu Ft	26																																																		
COM	\$2,441																																																				
A	\$2,539																																																				
B	\$2,661																																																				
COL/C	\$2,875																																																				
D	\$3,150																																																				
E	\$3,425																																																				
F	\$3,853																																																				
G	\$4,311																																																				
H	\$4,799																																																				
I	\$5,562																																																				
J	\$6,479																																																				
L1	\$5,013																																																				
L2	\$5,654																																																				

To Order, Specify:

- 1 Model Number
- 2 Wood Species - Cherry (CH1), Maple (MA1) or Walnut (WA1)
- 3 Wood Finish
- 4 Fabric Selection - vendor, pattern and color
 - A. Seat
 - B. Back
 - C. Arm
 - D. Headrest
- 5 Metal Leg Color - Black Sandtex (BSX), Soft Nickel (SNK) or Stardust Silver (STS)
- 6 Optional Wood Back Rail - available on any unit with two arms, specify and add \$136 list
- 7 Optional Power Center - Flush Mount (EC22) - Black (B) or White (W); \$504 list each, see page 201 for location availability
- 8 Optional Drink Holder(s) (DH) - add \$84 list each, indicate left or right arm
- 9 Optional Tablet Arm - indicate left (TBL) or right arm (TBR); add \$476 list
- 10 Optional Coordinating Wood Grain Laminate
Available - no upcharge. Finishes with an asterisk have a coordinating laminate available
- 11 Product Options

3 Wood Finish Options:

Cherry		EAR	Earthy
AUT	Autumn*	LGC	Legacy*
BRL	Barley*	PRL	Praline*
BBN	Bourbon*	SAF	Saffron*
BRG	Brighton*		
CLA	Classic*		
Maple		FLX	Flax ▲
ALE	Ale*	VEN	Venetian* ▲
BUT	Butterscotch		
CIN	Cinnamon*		
Walnut		TOF	Toffee*
AUB	Auburn*	TRF	Truffle*
ESP	Espresso	SIE	Sienna*
MCH	Mocha*		
NTO	Night owl*		













- 4 See a selection of graded in fabric manufacturers and patterns on pages 12-20. Contact Customer Service for additional fabric options.

Specifications



- Wood species - Cherry, Maple or Walnut.
- Seat has synthetic sheet webbing with cross strap reinforcement, 4 1/4" high density polyurethane foam.
- Back has high density polyurethane foam.
- Arms have 3/4" thick top and 1/4" thick side high density polyurethane foam.
- Plywood construction with locking tenons, glue and screws.
- Linking bracket included.
- Metal legs are 16 gauge steel tube with metal leveling glides.

When ordering Quickship products, place a "Q" in front of model number.
Example: QGT4901D

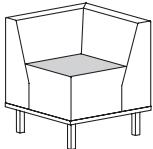

Description	Model	Specifications	List Price Per Grade												
Corner Seat High Back  CTC20S4UC center	CTC20S4UC CTC20S4UR CTC20S4UL <ul style="list-style-type: none"> · armless · 20" seat width · 7" high headrest · 41 3/4" high stand up surface · COM based on single fabric · multiple fabrics, see pages 204-206 for yardage requirements 	<table border="1"> <thead> <tr> <th>Dimensions</th> <th>D</th> <th>W</th> <th>H</th> </tr> </thead> <tbody> <tr> <td>Overall</td> <td>42</td> <td>42</td> <td>44 1/2</td> </tr> <tr> <td>Seat</td> <td>20</td> <td>20</td> <td>18</td> </tr> </tbody> </table>	Dimensions	D	W	H	Overall	42	42	44 1/2	Seat	20	20	18	COM \$4,067 A \$4,190 B \$4,312 COL/C \$4,526 D \$4,801 E \$5,076 F \$5,504 G \$5,961 H \$6,450 I \$7,214 J \$8,130 L1 \$6,664 L2 \$7,305
		Dimensions	D	W	H										
		Overall	42	42	44 1/2										
Seat	20	20	18												
<table border="1"> <thead> <tr> <th>Upholstery</th> <th colspan="3">Shipping</th> </tr> </thead> <tbody> <tr> <td>COM Ydg</td> <td>6 1/4</td> <td>Ctn Wt</td> <td>153</td> </tr> <tr> <td>COL Sq Ft</td> <td>144</td> <td>Cu Ft</td> <td>38</td> </tr> </tbody> </table>	Upholstery	Shipping			COM Ydg	6 1/4	Ctn Wt	153	COL Sq Ft	144	Cu Ft	38			
Upholstery	Shipping														
COM Ydg	6 1/4	Ctn Wt	153												
COL Sq Ft	144	Cu Ft	38												
 CTC20S4UR right	 CTC20S4UL left														
Corner Seat Privacy Back  CTC20S5UC center	CTC20S5UC CTC20S5UR CTC20S5UL <ul style="list-style-type: none"> · armless · 20" seat width · 14" high headrest · COM based on single fabric · multiple fabrics, see pages 204-206 for yardage requirements 	<table border="1"> <thead> <tr> <th>Dimensions</th> <th>D</th> <th>W</th> <th>H</th> </tr> </thead> <tbody> <tr> <td>Overall</td> <td>32</td> <td>32</td> <td>51 1/2</td> </tr> <tr> <td>Seat</td> <td>20</td> <td>20</td> <td>18</td> </tr> </tbody> </table>	Dimensions	D	W	H	Overall	32	32	51 1/2	Seat	20	20	18	COM \$2,519 A \$2,627 B \$2,763 COL/C \$3,002 D \$3,310 E \$3,619 F \$4,098 G \$4,610 H \$5,158 I \$6,013 J \$7,039 L1 \$5,397 L2 \$6,115
		Dimensions	D	W	H										
		Overall	32	32	51 1/2										
Seat	20	20	18												
<table border="1"> <thead> <tr> <th>Upholstery</th> <th colspan="3">Shipping</th> </tr> </thead> <tbody> <tr> <td>COM Ydg</td> <td>7</td> <td>Ctn Wt</td> <td>125</td> </tr> <tr> <td>COL Sq Ft</td> <td>161</td> <td>Cu Ft</td> <td>31</td> </tr> </tbody> </table>	Upholstery	Shipping			COM Ydg	7	Ctn Wt	125	COL Sq Ft	161	Cu Ft	31			
Upholstery	Shipping														
COM Ydg	7	Ctn Wt	125												
COL Sq Ft	161	Cu Ft	31												
 CTC20S5UR right	 CTC20S5UL left														
Corner Seat Privacy Back  CTC20S6UC center	CTC20S6UC CTC20S6UR CTC20S6UL <ul style="list-style-type: none"> · armless · 20" seat width · 14" high headrest · 41 3/4" high stand up surface · COM based on single fabric · multiple fabrics, see pages 204-206 for yardage requirements 	<table border="1"> <thead> <tr> <th>Dimensions</th> <th>D</th> <th>W</th> <th>H</th> </tr> </thead> <tbody> <tr> <td>Overall</td> <td>42</td> <td>42</td> <td>51 1/2</td> </tr> <tr> <td>Seat</td> <td>20</td> <td>20</td> <td>18</td> </tr> </tbody> </table>	Dimensions	D	W	H	Overall	42	42	51 1/2	Seat	20	20	18	COM \$4,146 A \$4,277 B \$4,414 COL/C \$4,654 D \$4,962 E \$5,269 F \$5,748 G \$6,262 H \$6,809 I \$7,663 J \$8,690 L1 \$7,048 L2 \$7,766
		Dimensions	D	W	H										
		Overall	42	42	51 1/2										
Seat	20	20	18												
<table border="1"> <thead> <tr> <th>Upholstery</th> <th colspan="3">Shipping</th> </tr> </thead> <tbody> <tr> <td>COM Ydg</td> <td>7</td> <td>Ctn Wt</td> <td>163</td> </tr> <tr> <td>COL Sq Ft</td> <td>161</td> <td>Cu Ft</td> <td>43</td> </tr> </tbody> </table>	Upholstery	Shipping			COM Ydg	7	Ctn Wt	163	COL Sq Ft	161	Cu Ft	43			
Upholstery	Shipping														
COM Ydg	7	Ctn Wt	163												
COL Sq Ft	161	Cu Ft	43												
 CTC20S6UR right	 CTC20S6UL left														
Corner Table Mid Back  CTC20T2UC center	CTC20T2UC CTC20T2UR CTC20T2UL <ul style="list-style-type: none"> · upholstered top · 23" table width · table height is same as arm height · COM based on single fabric · multiple fabrics, see pages 204-206 for yardage requirements 	<table border="1"> <thead> <tr> <th>Dimensions</th> <th>D</th> <th>W</th> <th>H</th> </tr> </thead> <tbody> <tr> <td>Overall</td> <td>32</td> <td>32</td> <td>37 1/2</td> </tr> <tr> <td>Table</td> <td>23</td> <td>23</td> <td>24 1/2</td> </tr> </tbody> </table>	Dimensions	D	W	H	Overall	32	32	37 1/2	Table	23	23	24 1/2	COM \$2,393 A \$2,476 B \$2,569 COL/C \$2,732 D \$2,940 E \$3,149 F \$3,475 G \$3,822 H \$4,194 I \$4,775 J \$5,471 L1 \$4,357 L2 \$4,844
		Dimensions	D	W	H										
		Overall	32	32	37 1/2										
Table	23	23	24 1/2												
<table border="1"> <thead> <tr> <th>Upholstery</th> <th colspan="3">Shipping</th> </tr> </thead> <tbody> <tr> <td>COM Ydg</td> <td>4 3/4</td> <td>Ctn Wt</td> <td>115</td> </tr> <tr> <td>COL Sq Ft</td> <td>110</td> <td>Cu Ft</td> <td>22</td> </tr> </tbody> </table>	Upholstery	Shipping			COM Ydg	4 3/4	Ctn Wt	115	COL Sq Ft	110	Cu Ft	22			
Upholstery	Shipping														
COM Ydg	4 3/4	Ctn Wt	115												
COL Sq Ft	110	Cu Ft	22												
 CTC20T2UR right	 CTC20T2UL left														

LOUNGE

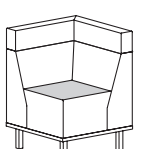
Description	Model	Specifications			List Price Per Grade		
		Dimensions	D	W	H	COM	
Comer Table Mid Back 	CTC20T2W • wood top • diagonal grain • 23" table width • table height is same as arm height • COM based on single fabric • multiple fabrics, see pages 204-206 for yardage requirements	Overall	32	32	37 1/2	COM	\$2,551
		Table	23	23	25	A	\$2,629
		Upholstery		Shipping		B	\$2,707
		COM Ydg	4	Ctn Wt	120	COL/C	\$2,844
		COL Sq Ft	92	Cu Ft	22	D	\$3,020
						E	\$3,196
						F	\$3,470
						G	\$3,763
						H	\$4,076
						I	\$4,564
						J	\$5,151
						L1	\$4,212
						L2	\$4,623
Comer Table High Back 	CTC20T3UC CTC20T3UR CTC20T3UL • upholstered top • 23" table width • table height is same as arm height • COM based on single fabric • multiple fabrics, see pages 204-206 for yardage requirements	Overall	32	32	44 1/2	COM	\$2,472
		Table	23	23	24 1/2	A	\$2,574
		Upholstery		Shipping		B	\$2,701
		COM Ydg	6 1/2	Ctn Wt	135	COL/C	\$2,923
		COL Sq Ft	150	Cu Ft	26	D	\$3,209
						E	\$3,495
						F	\$3,939
						G	\$4,416
						H	\$4,924
						I	\$5,718
						J	\$6,671
						L1	\$5,147
						L2	\$5,813
Comer Table High Back 	CTC20T3W • wood top • diagonal grain • 23" table width • table height is same as arm height • COM based on single fabric • multiple fabrics, see pages 204-206 for yardage requirements	Overall	32	32	44 1/2	COM	\$2,630
		Table	23	23	25	A	\$2,726
		Upholstery		Shipping		B	\$2,839
		COM Ydg	5 3/4	Ctn Wt	140	COL/C	\$3,035
		COL Sq Ft	133	Cu Ft	26	D	\$3,288
						E	\$3,541
						F	\$3,934
						G	\$4,356
						H	\$4,805
						I	\$5,508
						J	\$6,351
						L1	\$5,002
						L2	\$5,592

To Order, Specify:

- 1 Model Number
- 2 Wood Species - Cherry (CH1), Maple (MA1) or Walnut (WA1)
- 3 Wood Finish
- 4 Laminate Color Selection (Stand up Surface)
- 5 Fabric Selection - vendor, pattern and color
 - A. Seat
 - B. Back
 - C. Headrest
- 6 Metal Leg Color - Black Sandtex (BSX), Soft Nickel (SNK) or Stardust Silver (STS)
- 7 Optional Coordinating Wood Grain Laminate Available on Table Tops - no upcharge. Finishes with an asterisk have a coordinating laminate available
- 8 Product Options

3 Wood Finish Options:

- Cherry**
- | | |
|---------------|--------------|
| AUT Autumn* | EAR Earthy |
| BRL Barley* | LGC Legacy* |
| BBN Bourbon* | PRL Praline* |
| BRG Brighton* | SAF Saffron* |
| CLA Classic* | |
- Maple**
- | | |
|------------------|----------------|
| ALE Ale* | FLX Flax▲ |
| BUT Butterscotch | VEN Venetian*▲ |
| CIN Cinnamon* | |
- Walnut**
- | | |
|----------------|--------------|
| AUB Auburn* | TOF Toffee* |
| ESP Espresso | TRF Truffle* |
| MCH Mocha* | SIE Sienna* |
| NTO Night owl* | |





4 Laminate Color Selection (Stand Up Surface)

- | | |
|--------------------|----------------|
| ALB Alabaster | SHD Shadow |
| BBL Bridal Blanco | SLG Slate Grey |
| DWH Designer White | TAU Taupe |
| DOV Dove Grey | |

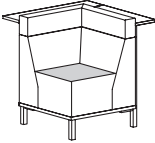
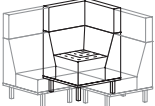

- 5 See a selection of graded fabric manufacturers and patterns on pages 12-20. Contact Customer Service for additional fabric options.

Specifications

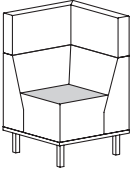
- Wood species - Cherry, Maple or Walnut.
- Seat has synthetic sheet webbing with cross strap reinforcement, 4 1/4" high density polyurethane foam.
- Back has high density polyurethane foam.
- Plywood construction with locking tenons, glue and screws.
- Linking bracket included.
- Metal legs are 16 gauge steel tube with metal leveling glides.
- 3/4" thick 10" deep laminate stand up surface with coordinating 3mm PVC edge supported by steel columns, 42" surface height.

Description	Model	Specifications	List Price Per Grade												
Corner Table High Back  CTC20T4UC center	CTC20T4UC CTC20T4UR CTC20T4UL <ul style="list-style-type: none"> · upholstered top · 23" table width · 41 3/4" high stand up surface · table height is same as arm height · COM based on single fabric · multiple fabrics, see pages 204-206 for yardage requirements 	<table border="1"> <thead> <tr> <th>Dimensions</th> <th>D</th> <th>W</th> <th>H</th> </tr> </thead> <tbody> <tr> <td>Overall</td> <td>42</td> <td>42</td> <td>44 1/2</td> </tr> <tr> <td>Table</td> <td>23</td> <td>23</td> <td>24 1/4</td> </tr> </tbody> </table>	Dimensions	D	W	H	Overall	42	42	44 1/2	Table	23	23	24 1/4	COM \$4,099 A \$4,225 B \$4,352 COL/C \$4,574 D \$4,860 E \$5,145 F \$5,591 G \$6,066 H \$6,575 I \$7,369 J \$8,322 L1 \$6,797 L2 \$7,464
		Dimensions	D	W	H										
		Overall	42	42	44 1/2										
Table	23	23	24 1/4												
<table border="1"> <thead> <tr> <th>Upholstery</th> <th colspan="3">Shipping</th> </tr> </thead> <tbody> <tr> <td>COM Ydg</td> <td>6 1/2</td> <td>Ctn Wt</td> <td>173</td> </tr> <tr> <td>COL Sq Ft</td> <td>150</td> <td>Cu Ft</td> <td>38</td> </tr> </tbody> </table>	Upholstery	Shipping			COM Ydg	6 1/2	Ctn Wt	173	COL Sq Ft	150	Cu Ft	38			
Upholstery	Shipping														
COM Ydg	6 1/2	Ctn Wt	173												
COL Sq Ft	150	Cu Ft	38												
 CTC20T4UR right	 CTC20T4UL left														
Corner Table High Back 	CTC20T4W <ul style="list-style-type: none"> · wood top · diagonal grain · 23" table width · 41 3/4" high stand up surface · table height is same as arm height · COM based on single fabric · multiple fabrics, see pages 204-206 for yardage requirements 	<table border="1"> <thead> <tr> <th>Dimensions</th> <th>D</th> <th>W</th> <th>H</th> </tr> </thead> <tbody> <tr> <td>Overall</td> <td>42</td> <td>42</td> <td>44 1/2</td> </tr> <tr> <td>Table</td> <td>23</td> <td>23</td> <td>25</td> </tr> </tbody> </table>	Dimensions	D	W	H	Overall	42	42	44 1/2	Table	23	23	25	COM \$4,256 A \$4,377 B \$4,489 COL/C \$4,686 D \$4,939 E \$5,192 F \$5,585 G \$6,006 H \$6,456 I \$7,158 J \$8,001 L1 \$6,653 L2 \$7,242
		Dimensions	D	W	H										
		Overall	42	42	44 1/2										
Table	23	23	25												
<table border="1"> <thead> <tr> <th>Upholstery</th> <th colspan="3">Shipping</th> </tr> </thead> <tbody> <tr> <td>COM Ydg</td> <td>5 3/4</td> <td>Ctn Wt</td> <td>178</td> </tr> <tr> <td>COL Sq Ft</td> <td>133</td> <td>Cu Ft</td> <td>38</td> </tr> </tbody> </table>	Upholstery	Shipping			COM Ydg	5 3/4	Ctn Wt	178	COL Sq Ft	133	Cu Ft	38			
Upholstery	Shipping														
COM Ydg	5 3/4	Ctn Wt	178												
COL Sq Ft	133	Cu Ft	38												
Corner Table Privacy Back  CTC20T5UC center	CTC20T5UC CTC20T5UR CTC20T5UL <ul style="list-style-type: none"> · upholstered top · 23" table width · table height is same as arm height · COM based on single fabric · multiple fabrics, see pages 204-206 for yardage requirements 	<table border="1"> <thead> <tr> <th>Dimensions</th> <th>D</th> <th>W</th> <th>H</th> </tr> </thead> <tbody> <tr> <td>Overall</td> <td>32</td> <td>32</td> <td>51 1/2</td> </tr> <tr> <td>Table</td> <td>23</td> <td>23</td> <td>24 1/2</td> </tr> </tbody> </table>	Dimensions	D	W	H	Overall	32	32	51 1/2	Table	23	23	24 1/2	COM \$2,551 A \$2,661 B \$2,803 COL/C \$3,051 D \$3,370 E \$3,688 F \$4,185 G \$4,716 H \$5,283 I \$6,168 J \$7,231 L1 \$5,531 L2 \$6,274
		Dimensions	D	W	H										
		Overall	32	32	51 1/2										
Table	23	23	24 1/2												
<table border="1"> <thead> <tr> <th>Upholstery</th> <th colspan="3">Shipping</th> </tr> </thead> <tbody> <tr> <td>COM Ydg</td> <td>7 1/4</td> <td>Ctn Wt</td> <td>148</td> </tr> <tr> <td>COL Sq Ft</td> <td>167</td> <td>Cu Ft</td> <td>31</td> </tr> </tbody> </table>	Upholstery	Shipping			COM Ydg	7 1/4	Ctn Wt	148	COL Sq Ft	167	Cu Ft	31			
Upholstery	Shipping														
COM Ydg	7 1/4	Ctn Wt	148												
COL Sq Ft	167	Cu Ft	31												
 CTC20T5UR right	 CTC20T5UL left														
Corner Table Privacy Back 	CTC20T5W <ul style="list-style-type: none"> · wood top · diagonal grain · 23" table width · table height is same as arm height · COM based on single fabric · multiple fabrics, see pages 204-206 for yardage requirements 	<table border="1"> <thead> <tr> <th>Dimensions</th> <th>D</th> <th>W</th> <th>H</th> </tr> </thead> <tbody> <tr> <td>Overall</td> <td>32</td> <td>32</td> <td>51 1/2</td> </tr> <tr> <td>Table</td> <td>23</td> <td>23</td> <td>25</td> </tr> </tbody> </table>	Dimensions	D	W	H	Overall	32	32	51 1/2	Table	23	23	25	COM \$2,708 A \$2,813 B \$2,940 COL/C \$3,163 D \$3,449 E \$3,734 F \$4,179 G \$4,655 H \$5,163 I \$5,958 J \$6,911 L1 \$5,386 L2 \$6,053
		Dimensions	D	W	H										
		Overall	32	32	51 1/2										
Table	23	23	25												
<table border="1"> <thead> <tr> <th>Upholstery</th> <th colspan="3">Shipping</th> </tr> </thead> <tbody> <tr> <td>COM Ydg</td> <td>6 1/2</td> <td>Ctn Wt</td> <td>153</td> </tr> <tr> <td>COL Sq Ft</td> <td>150</td> <td>Cu Ft</td> <td>31</td> </tr> </tbody> </table>	Upholstery	Shipping			COM Ydg	6 1/2	Ctn Wt	153	COL Sq Ft	150	Cu Ft	31			
Upholstery	Shipping														
COM Ydg	6 1/2	Ctn Wt	153												
COL Sq Ft	150	Cu Ft	31												

LOUNGE

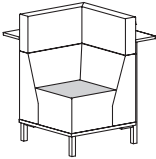
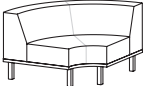
Description	Model	Specifications	List Price Per Grade																								
Corner Table Privacy Back  CTC20T6UC center	CTC20T6UC CTC20T6UR CTC20T6UL • upholstered top • 23" table width • 41 ¾" high stand up surface • table height is same as arm height • COM based on single fabric • multiple fabrics, see pages 204-206 for yardage requirements	<table border="1"> <thead> <tr> <th>Dimensions</th> <th>D</th> <th>W</th> <th>H</th> </tr> </thead> <tbody> <tr> <td>Overall</td> <td>42</td> <td>42</td> <td>51 ½</td> </tr> <tr> <td>Table</td> <td>23</td> <td>23</td> <td>24 ½</td> </tr> <tr> <th colspan="2">Upholstery</th> <th colspan="2">Shipping</th> </tr> <tr> <td>COM Ydg</td> <td>7 ¼</td> <td>Ctn Wt</td> <td>186</td> </tr> <tr> <td>COL Sq Ft</td> <td>167</td> <td>Cu Ft</td> <td>43</td> </tr> </tbody> </table>	Dimensions	D	W	H	Overall	42	42	51 ½	Table	23	23	24 ½	Upholstery		Shipping		COM Ydg	7 ¼	Ctn Wt	186	COL Sq Ft	167	Cu Ft	43	COM \$4,177 A \$4,312 B \$4,454 COL/C \$4,701 D \$5,021 E \$5,339 F \$5,835 G \$6,367 H \$6,934 I \$7,819 J \$8,882 L1 \$7,181 L2 \$7,925
			Dimensions	D	W	H																					
			Overall	42	42	51 ½																					
Table	23	23	24 ½																								
Upholstery		Shipping																									
COM Ydg	7 ¼	Ctn Wt	186																								
COL Sq Ft	167	Cu Ft	43																								
 CTC20T6UR right	 CTC20T6UL left																										
Corner Table Privacy Back  CTC20T6W • wood top • diagonal grain • 23" table width • 41 ¾" high stand up surface • table height is same as arm height • COM based on single fabric • multiple fabrics, see pages 204-206 for yardage requirements		<table border="1"> <thead> <tr> <th>Dimensions</th> <th>D</th> <th>W</th> <th>H</th> </tr> </thead> <tbody> <tr> <td>Overall</td> <td>42</td> <td>42</td> <td>51 ½</td> </tr> <tr> <td>Table</td> <td>23</td> <td>23</td> <td>25</td> </tr> <tr> <th colspan="2">Upholstery</th> <th colspan="2">Shipping</th> </tr> <tr> <td>COM Ydg</td> <td>6 ½</td> <td>Ctn Wt</td> <td>191</td> </tr> <tr> <td>COL Sq Ft</td> <td>150</td> <td>Cu Ft</td> <td>43</td> </tr> </tbody> </table>	Dimensions	D	W	H	Overall	42	42	51 ½	Table	23	23	25	Upholstery		Shipping		COM Ydg	6 ½	Ctn Wt	191	COL Sq Ft	150	Cu Ft	43	COM \$4,335 A \$4,464 B \$4,591 COL/C \$4,814 D \$5,099 E \$5,385 F \$5,830 G \$6,307 H \$6,815 I \$7,609 J \$8,561 L1 \$7,037 L2 \$7,703
Dimensions	D	W	H																								
Overall	42	42	51 ½																								
Table	23	23	25																								
Upholstery		Shipping																									
COM Ydg	6 ½	Ctn Wt	191																								
COL Sq Ft	150	Cu Ft	43																								
90° Curved Seat Low Back 	CTI32121 • 12" inside radius • 44" outside radius • COM based on single fabric • multiple fabrics, see pages 204-206 for yardage requirements • see pages 212-217 for application	<table border="1"> <thead> <tr> <th>Dimensions</th> <th>D</th> <th>W</th> <th>H</th> </tr> </thead> <tbody> <tr> <td>Overall</td> <td>32</td> <td></td> <td>30 ½</td> </tr> <tr> <td>Seat</td> <td>20</td> <td></td> <td>18</td> </tr> <tr> <th colspan="2">Upholstery</th> <th colspan="2">Shipping</th> </tr> <tr> <td>COM Ydg</td> <td>5 ½</td> <td>Ctn Wt</td> <td>105</td> </tr> <tr> <td>COL Sq Ft</td> <td>127</td> <td>Cu Ft</td> <td>36</td> </tr> </tbody> </table>	Dimensions	D	W	H	Overall	32		30 ½	Seat	20		18	Upholstery		Shipping		COM Ydg	5 ½	Ctn Wt	105	COL Sq Ft	127	Cu Ft	36	COM \$2,034 A \$2,119 B \$2,226 COL/C \$2,415 D \$2,657 E \$2,898 F \$3,275 G \$3,679 H \$4,108 I \$4,780 J \$5,586 L1 \$4,296 L2 \$4,861
Dimensions	D	W	H																								
Overall	32		30 ½																								
Seat	20		18																								
Upholstery		Shipping																									
COM Ydg	5 ½	Ctn Wt	105																								
COL Sq Ft	127	Cu Ft	36																								

LOUNGE

To Order, Specify:

- 1 Model Number
- 2 Wood Species - Cherry (CH1), Maple (MA1) or Walnut (WA1)
- 3 Wood Finish
- 4 Laminate Color Selection (Stand up Surface)
- 5 Fabric Selection - vendor, pattern and color
 - A. Seat
 - B. Back
 - C. Headrest
- 6 Metal Leg Color - Black Sandtex (BSX), Soft Nickel (SNK) or Stardust Silver (STS)
- 7 Optional Coordinating Wood Grain Laminate Available on Table Tops - no upcharge. Finishes with an asterisk have a coordinating laminate available
- 8 Product Options

3 Wood Finish Options:

- Cherry**
- | | |
|---------------|--------------|
| AUT Autumn* | EAR Earthy |
| BRL Barley* | LGC Legacy* |
| BBN Bourbon* | PRL Praline* |
| BRG Brighton* | SAF Saffron* |
| CLA Classic* | |
- Maple**
- | | |
|------------------|----------------|
| ALE Ale* | FLX Flax▲ |
| BUT Butterscotch | VEN Venetian*▲ |
| CIN Cinnamon* | |
- Walnut**
- | | |
|----------------|--------------|
| AUB Auburn* | TOF Toffee* |
| ESP Espresso | TRF Truffle* |
| MCH Mocha* | SIE Sienna* |
| NTO Night owl* | |



4 Laminate Color Selection (Stand Up Surface)

- | | |
|--------------------|----------------|
| ALB Alabaster | SHD Shadow |
| BBL Bridal Blanco | SLG Slate Grey |
| DWH Designer White | TAU Taupe |
| DOV Dove Grey | |

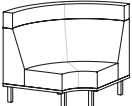

5 See a selection of graded fabric manufacturers and patterns on pages 12-20. Contact Customer Service for additional fabric options.

Specifications

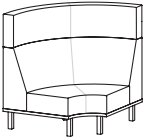
- Wood species - Cherry, Maple or Walnut.
- Table has ¾" high density polyurethane foam.
- Seat has synthetic sheet webbing with cross strap reinforcement, 4 ½" high density foam.
- Back has high density polyurethane foam.
- Plywood construction with locking tenons, glue and screws.
- Linking bracket included.
- Metal legs are 16 gauge steel tube with metal leveling glides.
- ¾" thick 10" deep laminate stand up surface with coordinating 3mm PVC edge supported by steel columns, 42" surface height.

Description	① Model	Specifications				List Price Per Grade	
90° Curved Seat Mid Back 	CTI32122 · 12" inside radius · 44" outside radius · COM based on single fabric · multiple fabrics, see pages 204-206 for yardage requirements · see pages 212-217 for application	Dimensions		D	W	H	COM \$2,192 A \$2,286 B \$2,409 COL/C \$2,622 D \$2,897 E \$3,173 F \$3,600 G \$4,058 H \$4,547 I \$5,310 J \$6,226 L1 \$4,760 L2 \$5,402
		Overall	32		37 1/2		
		Seat	20		18		
		Upholstery		Shipping			
		COM Ydg	6 1/4	Ctn Wt	110		
		COL Sq Ft	144	Cu Ft	46		
90° Curved Seat High Back 	CTI32123 · 12" inside radius · 44" outside radius · 7" high headrest · COM based on single fabric · multiple fabrics, see pages 204-206 for yardage requirements · see pages 212-217 for application	Dimensions		D	W	H	COM \$2,349 A \$2,464 B \$2,620 COL/C \$2,893 D \$3,245 E \$3,598 F \$4,145 G \$4,731 H \$5,357 I \$6,334 J \$7,507 L1 \$5,631 L2 \$6,451
		Overall	32		44 1/2		
		Seat	20		18		
		Upholstery		Shipping			
		COM Ydg	8	Ctn Wt	130		
		COL Sq Ft	184	Cu Ft	56		
90° Curved Seat High Back 	CTI32124 · 12" inside radius · 44" outside radius · 7" high headrest · 41 3/4" high stand up surface · COM based on single fabric · multiple fabrics, see pages 204-206 for yardage requirements · power center not available · see pages 212-217 for application	Dimensions		D	W	H	COM \$3,275 A \$3,404 B \$3,560 COL/C \$3,834 D \$4,186 E \$4,538 F \$5,085 G \$5,670 H \$6,296 I \$7,274 J \$8,447 L1 \$6,570 L2 \$7,390
		Overall	42		44 1/2		
		Seat	20		18		
		Upholstery		Shipping			
		COM Ydg	8	Ctn Wt	183		
		COL Sq Ft	184	Cu Ft	68		
90° Curved Seat Privacy Back 	CTI32125 · 12" inside radius · 44" outside radius · 14" high headrest · COM based on single fabric · multiple fabrics, see pages 204-206 for yardage requirements · see pages 212-217 for application	Dimensions		D	W	H	COM \$2,507 A \$2,633 B \$2,809 COL/C \$3,117 D \$3,513 E \$3,909 F \$4,525 G \$5,184 H \$5,888 I \$6,987 J \$8,307 L1 \$6,195 L2 \$7,118
		Overall	32		51 1/2		
		Seat	20		18		
		Upholstery		Shipping			
		COM Ydg	9	Ctn Wt	135		
		COL Sq Ft	207	Cu Ft	66		

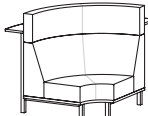
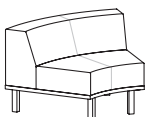
LOUNGE

Description	Model	Specifications				List Price Per Grade	
		Dimensions	D	W	H	COM	
90° Curved Seat Privacy Back 	CTI32126 • 12" inside radius • 44" outside radius • 14" high headrest • 41 3/4" high stand up surface • COM based on single fabric • multiple fabrics, see pages 204-206 for yardage requirementspower center not available • see pages 212-217 for application	Overall	42		51 1/2	COM	\$3,433
		Seat	20		18	A	\$3,574
						B	\$3,749
						COL/C	\$4,057
						D	\$4,452
						E	\$4,848
						F	\$5,465
						G	\$6,124
						H	\$6,828
						I	\$7,927
				J	\$9,247		
				L1	\$7,135		
				L2	\$8,059		
45° Curved Seat Low Back 	CTI32301 • 30" inside radius • 62" outside radius • COM based on single fabric • multiple fabrics, see pages 204-206 for yardage requirements • see pages 212-217 for application	Overall	32		30 1/2	COM	\$1,974
		Seat	20		18	A	\$2,044
						B	\$2,123
						COL/C	\$2,259
						D	\$2,434
						E	\$2,611
						F	\$2,885
						G	\$3,178
						H	\$3,491
						I	\$3,979
				J	\$4,565		
				L1	\$3,627		
				L2	\$4,038		
45° Curved Seat Mid Back 	CTI32302 • 30" inside radius • 62" outside radius • COM based on single fabric • multiple fabrics, see pages 204-206 for yardage requirements • see pages 212-217 for application	Overall	32		37 1/2	COM	\$2,132
		Seat	20		18	A	\$2,207
						B	\$2,289
						COL/C	\$2,434
						D	\$2,621
						E	\$2,808
						F	\$3,099
						G	\$3,411
						H	\$3,743
						I	\$4,262
				J	\$4,885		
				L1	\$3,889		
				L2	\$4,324		

To Order, Specify:

- 1 Model Number
- 2 Wood Species - Cherry (CH1), Maple (MA1) or Walnut (WA1)
- 3 Wood Finish
- 4 Laminate Color Selection (Stand up Surface)
- 5 Fabric Selection - vendor, pattern and color
 - A. Seat
 - B. Back
 - C. Headrest
- 6 Metal Leg Color - Black Sandtex (BSX), Soft Nickel (SNK) or Stardust Silver (STS)
- 7 Product Options

6 Wood Finish Options:

- Cherry**
- | | |
|--------------|-------------|
| AUT Autumn | EAR Earthy |
| BRL Barley | LGC Legacy |
| BBN Bourbon | PRL Praline |
| BRG Brighton | SAF Saffron |
| CLA Classic | |
- Maple**
- | | |
|------------------|----------------|
| ALE Ale | FLX Flax ▲ |
| BUT Butterscotch | VEN Venetian ▲ |
| CIN Cinnamon | |
- Walnut**
- | | |
|---------------|-------------|
| AUB Auburn | TOF Toffee |
| ESP Espresso | TRF Truffle |
| MCH Mocha | SIE Sienna |
| NTO Night owl | |

4 Laminate Color Selection (Stand Up Surface)

- | | |
|--------------------|----------------|
| ALB Alabaster | SHD Shadow |
| BBL Bridal Blanco | SLG Slate Grey |
| DWH Designer White | TAU Taupe |
| DOV Dove Grey | |



- 5 See a selection of graded fabric manufacturers and patterns on pages 12-20. Contact Customer Service for additional fabric options.

Specifications

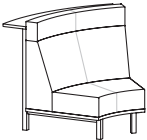
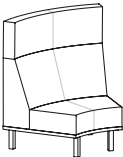
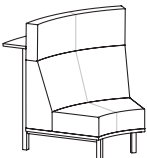
- Wood species - Cherry, Maple or Walnut.
- Table has 3/4" high density polyurethane foam.
- Seat has synthetic sheet webbing with cross strap reinforcement, 4 1/4" high density polyurethane foam.
- Back has high density polyurethane foam.
- Plywood construction with locking tenons, glue and screws.
- Linking bracket included.
- Metal legs are 16 gauge steel tube with metal leveling glides.
- 3/4" thick 10" deep laminate stand up surface with coordinating 3mm PVC edge supported by steel columns, 42" surface height.

Description	① Model	Specifications				List Price Per Grade	
45° Curved Seat High Back 	CTI32303 · 30" inside radius · 62" outside radius · 7" high headrest · COM based on single fabric · multiple fabrics, see pages 204-206 for yardage requirements · see pages 212-217 for application	Dimensions		D	W	H	COM \$2,289 A \$2,381 B \$2,493 COL/C \$2,690 D \$2,943 E \$3,196 F \$3,589 G \$4,010 H \$4,460 I \$5,162 J \$6,005 L1 \$4,656 L2 \$5,246
		Overall	32		44 ½		
		Seat	20		18		
		Upholstery		Shipping			
		COM Ydg	5 ¾	Ctn Wt	112		
		COL Sq Ft	133	Cu Ft	42		
45° Curved Seat High Back 	CTI32304 · 30" inside radius · 62" outside radius · 7" high headrest · 41 ¾" high stand up surface · COM based on single fabric · multiple fabrics, see pages 204-206 for yardage requirements · see pages 212-217 for application	Dimensions		D	W	H	COM \$3,244 A \$3,350 B \$3,462 COL/C \$3,659 D \$3,912 E \$4,165 F \$4,557 G \$4,980 H \$5,429 I \$6,131 J \$6,975 L1 \$5,625 L2 \$6,215
		Overall	42		44 ½		
		Seat	20		18		
		Upholstery		Shipping			
		COM Ydg	5 ¾	Ctn Wt	150		
		COL Sq Ft	133	Cu Ft	54		
45° Curved Seat Privacy Back 	CTI32305 · 30" inside radius · 62" outside radius · 14" high headrest · COM based on single fabric · multiple fabrics, see pages 204-206 for yardage requirements · see pages 212-217 for application	Dimensions		D	W	H	COM \$2,447 A \$2,546 B \$2,667 COL/C \$2,882 D \$3,157 E \$3,431 F \$3,859 G \$4,317 H \$4,805 I \$5,569 J \$6,485 L1 \$5,019 L2 \$5,660
		Overall	32		51 ½		
		Seat	20		18		
		Upholstery		Shipping			
		COM Ydg	6 ¼	Ctn Wt	117		
		COL Sq Ft	144	Cu Ft	50		
45° Curved Seat Privacy Back 	CTI32306 · 30" inside radius · 62" outside radius · 14" high headrest · 41 ¾" high stand up surface · COM based on single fabric · multiple fabrics, see pages 204-206 for yardage requirements · see pages 212-217 for application	Dimensions		D	W	H	COM \$3,401 A \$3,515 B \$3,637 COL/C \$3,850 D \$4,125 E \$4,400 F \$4,827 G \$5,286 H \$5,774 I \$6,538 J \$7,454 L1 \$5,989 L2 \$6,629
		Overall	42		51 ½		
		Seat	20		18		
		Upholstery		Shipping			
		COM Ydg	6 ¼	Ctn Wt	155		
		COL Sq Ft	144	Cu Ft	62		

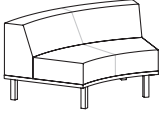
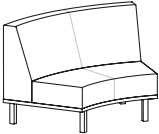
LOUNGE

Description	Model	Specifications	List Price Per Grade																																																		
45° Curved Seat Low Back 	CTI32451 • 45" inside radius • 77" outside radius • COM based on single fabric • multiple fabrics, see pages 204-206 for yardage requirements • see pages 212-217 for application	<table border="1"> <thead> <tr> <th>Dimensions</th> <th>D</th> <th>W</th> <th>H</th> </tr> </thead> <tbody> <tr> <td>Overall</td> <td>32</td> <td></td> <td>30 ½</td> </tr> <tr> <td>Seat</td> <td>20</td> <td></td> <td>18</td> </tr> <tr> <th colspan="2">Upholstery</th> <th colspan="2">Shipping</th> </tr> <tr> <td>COM Ydg</td> <td>5</td> <td>Ctn Wt</td> <td>110</td> </tr> <tr> <td>COL Sq Ft</td> <td>115</td> <td>Cu Ft</td> <td>34</td> </tr> </tbody> </table>	Dimensions	D	W	H	Overall	32		30 ½	Seat	20		18	Upholstery		Shipping		COM Ydg	5	Ctn Wt	110	COL Sq Ft	115	Cu Ft	34	<table border="1"> <tbody> <tr> <td>COM</td> <td>\$2,014</td> </tr> <tr> <td>A</td> <td>\$2,094</td> </tr> <tr> <td>B</td> <td>\$2,192</td> </tr> <tr> <td>COL/C</td> <td>\$2,363</td> </tr> <tr> <td>D</td> <td>\$2,582</td> </tr> <tr> <td>E</td> <td>\$2,803</td> </tr> <tr> <td>F</td> <td>\$3,145</td> </tr> <tr> <td>G</td> <td>\$3,512</td> </tr> <tr> <td>H</td> <td>\$3,902</td> </tr> <tr> <td>I</td> <td>\$4,513</td> </tr> <tr> <td>J</td> <td>\$5,246</td> </tr> <tr> <td>L1</td> <td>\$4,073</td> </tr> <tr> <td>L2</td> <td>\$4,586</td> </tr> </tbody> </table>	COM	\$2,014	A	\$2,094	B	\$2,192	COL/C	\$2,363	D	\$2,582	E	\$2,803	F	\$3,145	G	\$3,512	H	\$3,902	I	\$4,513	J	\$5,246	L1	\$4,073	L2	\$4,586
		Dimensions	D	W	H																																																
Overall	32		30 ½																																																		
Seat	20		18																																																		
Upholstery		Shipping																																																			
COM Ydg	5	Ctn Wt	110																																																		
COL Sq Ft	115	Cu Ft	34																																																		
COM	\$2,014																																																				
A	\$2,094																																																				
B	\$2,192																																																				
COL/C	\$2,363																																																				
D	\$2,582																																																				
E	\$2,803																																																				
F	\$3,145																																																				
G	\$3,512																																																				
H	\$3,902																																																				
I	\$4,513																																																				
J	\$5,246																																																				
L1	\$4,073																																																				
L2	\$4,586																																																				
45° Curved Seat Mid Back 	CTI32452 • 45" inside radius • 77" outside radius • COM based on single fabric • multiple fabrics, see pages 204-206 for yardage requirements • see pages 212-217 for application	<table border="1"> <thead> <tr> <th>Dimensions</th> <th>D</th> <th>W</th> <th>H</th> </tr> </thead> <tbody> <tr> <td>Overall</td> <td>32</td> <td></td> <td>37 ½</td> </tr> <tr> <td>Seat</td> <td>20</td> <td></td> <td>18</td> </tr> <tr> <th colspan="2">Upholstery</th> <th colspan="2">Shipping</th> </tr> <tr> <td>COM Ydg</td> <td>5 ½</td> <td>Ctn Wt</td> <td>120</td> </tr> <tr> <td>COL Sq Ft</td> <td>127</td> <td>Cu Ft</td> <td>44</td> </tr> </tbody> </table>	Dimensions	D	W	H	Overall	32		37 ½	Seat	20		18	Upholstery		Shipping		COM Ydg	5 ½	Ctn Wt	120	COL Sq Ft	127	Cu Ft	44	<table border="1"> <tbody> <tr> <td>COM</td> <td>\$2,172</td> </tr> <tr> <td>A</td> <td>\$2,259</td> </tr> <tr> <td>B</td> <td>\$2,366</td> </tr> <tr> <td>COL/C</td> <td>\$2,554</td> </tr> <tr> <td>D</td> <td>\$2,797</td> </tr> <tr> <td>E</td> <td>\$3,038</td> </tr> <tr> <td>F</td> <td>\$3,415</td> </tr> <tr> <td>G</td> <td>\$3,818</td> </tr> <tr> <td>H</td> <td>\$4,248</td> </tr> <tr> <td>I</td> <td>\$4,920</td> </tr> <tr> <td>J</td> <td>\$5,726</td> </tr> <tr> <td>L1</td> <td>\$4,436</td> </tr> <tr> <td>L2</td> <td>\$5,001</td> </tr> </tbody> </table>	COM	\$2,172	A	\$2,259	B	\$2,366	COL/C	\$2,554	D	\$2,797	E	\$3,038	F	\$3,415	G	\$3,818	H	\$4,248	I	\$4,920	J	\$5,726	L1	\$4,436	L2	\$5,001
		Dimensions	D	W	H																																																
Overall	32		37 ½																																																		
Seat	20		18																																																		
Upholstery		Shipping																																																			
COM Ydg	5 ½	Ctn Wt	120																																																		
COL Sq Ft	127	Cu Ft	44																																																		
COM	\$2,172																																																				
A	\$2,259																																																				
B	\$2,366																																																				
COL/C	\$2,554																																																				
D	\$2,797																																																				
E	\$3,038																																																				
F	\$3,415																																																				
G	\$3,818																																																				
H	\$4,248																																																				
I	\$4,920																																																				
J	\$5,726																																																				
L1	\$4,436																																																				
L2	\$5,001																																																				
45° Curved Seat High Back 	CTI32453 • 45" inside radius • 77" outside radius • 7" high headrest • COM based on single fabric • multiple fabrics, see pages 204-206 for yardage requirements • see pages 212-217 for application	<table border="1"> <thead> <tr> <th>Dimensions</th> <th>D</th> <th>W</th> <th>H</th> </tr> </thead> <tbody> <tr> <td>Overall</td> <td>32</td> <td></td> <td>44 ½</td> </tr> <tr> <td>Seat</td> <td>20</td> <td></td> <td>18</td> </tr> <tr> <th colspan="2">Upholstery</th> <th colspan="2">Shipping</th> </tr> <tr> <td>COM Ydg</td> <td>7 ¼</td> <td>Ctn Wt</td> <td>135</td> </tr> <tr> <td>COL Sq Ft</td> <td>167</td> <td>Cu Ft</td> <td>54</td> </tr> </tbody> </table>	Dimensions	D	W	H	Overall	32		44 ½	Seat	20		18	Upholstery		Shipping		COM Ydg	7 ¼	Ctn Wt	135	COL Sq Ft	167	Cu Ft	54	<table border="1"> <tbody> <tr> <td>COM</td> <td>\$2,329</td> </tr> <tr> <td>A</td> <td>\$2,436</td> </tr> <tr> <td>B</td> <td>\$2,578</td> </tr> <tr> <td>COL/C</td> <td>\$2,826</td> </tr> <tr> <td>D</td> <td>\$3,144</td> </tr> <tr> <td>E</td> <td>\$3,463</td> </tr> <tr> <td>F</td> <td>\$3,959</td> </tr> <tr> <td>G</td> <td>\$4,491</td> </tr> <tr> <td>H</td> <td>\$5,057</td> </tr> <tr> <td>I</td> <td>\$5,943</td> </tr> <tr> <td>J</td> <td>\$7,006</td> </tr> <tr> <td>L1</td> <td>\$5,306</td> </tr> <tr> <td>L2</td> <td>\$6,050</td> </tr> </tbody> </table>	COM	\$2,329	A	\$2,436	B	\$2,578	COL/C	\$2,826	D	\$3,144	E	\$3,463	F	\$3,959	G	\$4,491	H	\$5,057	I	\$5,943	J	\$7,006	L1	\$5,306	L2	\$6,050
		Dimensions	D	W	H																																																
Overall	32		44 ½																																																		
Seat	20		18																																																		
Upholstery		Shipping																																																			
COM Ydg	7 ¼	Ctn Wt	135																																																		
COL Sq Ft	167	Cu Ft	54																																																		
COM	\$2,329																																																				
A	\$2,436																																																				
B	\$2,578																																																				
COL/C	\$2,826																																																				
D	\$3,144																																																				
E	\$3,463																																																				
F	\$3,959																																																				
G	\$4,491																																																				
H	\$5,057																																																				
I	\$5,943																																																				
J	\$7,006																																																				
L1	\$5,306																																																				
L2	\$6,050																																																				

To Order, Specify:

- 1 Model Number
- 2 Wood Species - Cherry (CH1), Maple (MA1) or Walnut (WA1)
- 3 Wood Finish
- 4 Laminate Color Selection (Stand up Surface)
- 5 Fabric Selection - vendor, pattern and color
 - A. Seat
 - B. Back
 - C. Headrest
- 6 Metal Leg Color - Black Sandtex (BSX), Soft Nickel (SNK) or Stardust Silver (STS)
- 7 Optional Power Center - Flush Mount (EC22) - Black (B) or White (W); \$504 list each, see page 201 for location availability
- 8 Product Options

3 Wood Finish Options:

- Cherry**
- | | |
|--------------|-------------|
| AUT Autumn | EAR Earthy |
| BRL Barley | LGC Legacy |
| BBN Bourbon | PRL Praline |
| BRG Brighton | SAF Saffron |
| CLA Classic | |
- Maple**
- | | |
|------------------|----------------|
| ALE Ale | FLX Flax ▲ |
| BUT Butterscotch | VEN Venetian ▲ |
| CIN Cinnamon | |
- Walnut**
- | | |
|---------------|-------------|
| AUB Auburn | TOF Toffee |
| ESP Espresso | TRF Truffle |
| MCH Mocha | SIE Sienna |
| NTO Night owl | |





4 Laminate Color Selection (Stand Up Surface)

- | | |
|--------------------|----------------|
| ALB Alabaster | SHD Shadow |
| BBL Bridal Blanco | SLG Slate Grey |
| DWH Designer White | TAU Taupe |
| DOV Dove Grey | |

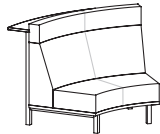

- 5 See a selection of graded in fabric manufacturers and patterns on pages 12-20. Contact Customer Service for additional fabric options.

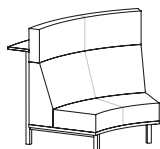
Specifications

- Wood species - Cherry, Maple or Walnut.
- Seat has synthetic sheet webbing with cross strap reinforcement, 4 ¼" high density polyurethane foam.
- Back has high density polyurethane foam.
- Plywood construction with locking tenons, glue and screws.
- Linking bracket included.
- Metal legs are 16 gauge steel tube with metal leveling glides.
- ¾" thick 10" deep laminate stand up surface with coordinating 3mm PVC edge supported by steel columns, 42" surface height.

Description	① Model	Specifications	List Price Per Grade												
45° Curved Seat High Back 	CTI32454 · 45" inside radius · 77" outside radius · 7" high headrest · 41 ¾" high stand up surface · COM based on single fabric · multiple fabrics, see pages 204-206 for yardage requirements · see pages 212-217 for application	<table border="1"> <thead> <tr> <th>Dimensions</th> <th>D</th> <th>W</th> <th>H</th> </tr> </thead> <tbody> <tr> <td>Overall</td> <td>42</td> <td></td> <td>44 ½</td> </tr> <tr> <td>Seat</td> <td>20</td> <td></td> <td>18</td> </tr> </tbody> </table>	Dimensions	D	W	H	Overall	42		44 ½	Seat	20		18	COM \$3,749 A \$3,877 B \$4,019 COL/C \$4,267 D \$4,586 E \$4,904 F \$5,401 G \$5,932 H \$6,499 I \$7,384 J \$8,447 L1 \$6,747 L2 \$7,490
		Dimensions	D	W	H										
Overall	42		44 ½												
Seat	20		18												
<table border="1"> <thead> <tr> <th>Upholstery</th> <th colspan="3">Shipping</th> </tr> </thead> <tbody> <tr> <td>COM Ydg</td> <td>7 ¼</td> <td>Ctn Wt</td> <td>173</td> </tr> <tr> <td>COL Sq Ft</td> <td>167</td> <td>Cu Ft</td> <td>66</td> </tr> </tbody> </table>	Upholstery	Shipping			COM Ydg	7 ¼	Ctn Wt	173	COL Sq Ft	167	Cu Ft	66			
Upholstery	Shipping														
COM Ydg	7 ¼	Ctn Wt	173												
COL Sq Ft	167	Cu Ft	66												
45° Curved Seat Privacy Back 	CTI32455 · 45" inside radius · 77" outside radius · 14" high headrest · COM based on single fabric · multiple fabrics, see pages 204-206 for yardage requirements · see pages 212-217 for application	<table border="1"> <thead> <tr> <th>Dimensions</th> <th>D</th> <th>W</th> <th>H</th> </tr> </thead> <tbody> <tr> <td>Overall</td> <td>32</td> <td></td> <td>51 ½</td> </tr> <tr> <td>Seat</td> <td>20</td> <td></td> <td>18</td> </tr> </tbody> </table>	Dimensions	D	W	H	Overall	32		51 ½	Seat	20		18	COM \$2,487 A \$2,606 B \$2,767 COL/C \$3,049 D \$3,412 E \$3,775 F \$4,339 G \$4,944 H \$5,589 I \$6,597 J \$7,806 L1 \$5,871 L2 \$6,717
		Dimensions	D	W	H										
Overall	32		51 ½												
Seat	20		18												
<table border="1"> <thead> <tr> <th>Upholstery</th> <th colspan="3">Shipping</th> </tr> </thead> <tbody> <tr> <td>COM Ydg</td> <td>8 ¼</td> <td>Ctn Wt</td> <td>140</td> </tr> <tr> <td>COL Sq Ft</td> <td>190</td> <td>Cu Ft</td> <td>63</td> </tr> </tbody> </table>	Upholstery	Shipping			COM Ydg	8 ¼	Ctn Wt	140	COL Sq Ft	190	Cu Ft	63			
Upholstery	Shipping														
COM Ydg	8 ¼	Ctn Wt	140												
COL Sq Ft	190	Cu Ft	63												
45° Curved Seat Privacy Back 	CTI32456 · 45" inside radius · 77" outside radius · 14" high headrest · 41 ¾" high stand up surface · COM based on single fabric · multiple fabrics, see pages 204-206 for yardage requirements · see pages 212-217 for application	<table border="1"> <thead> <tr> <th>Dimensions</th> <th>D</th> <th>W</th> <th>H</th> </tr> </thead> <tbody> <tr> <td>Overall</td> <td>42</td> <td></td> <td>51 ½</td> </tr> <tr> <td>Seat</td> <td>20</td> <td></td> <td>18</td> </tr> </tbody> </table>	Dimensions	D	W	H	Overall	42		51 ½	Seat	20		18	COM \$3,906 A \$4,046 B \$4,208 COL/C \$4,490 D \$4,853 E \$5,216 F \$5,780 G \$6,384 H \$7,030 I \$8,038 J \$9,247 L1 \$7,312 L2 \$8,158
		Dimensions	D	W	H										
Overall	42		51 ½												
Seat	20		18												
<table border="1"> <thead> <tr> <th>Upholstery</th> <th colspan="3">Shipping</th> </tr> </thead> <tbody> <tr> <td>COM Ydg</td> <td>8 ¼</td> <td>Ctn Wt</td> <td>178</td> </tr> <tr> <td>COL Sq Ft</td> <td>190</td> <td>Cu Ft</td> <td>75</td> </tr> </tbody> </table>	Upholstery	Shipping			COM Ydg	8 ¼	Ctn Wt	178	COL Sq Ft	190	Cu Ft	75			
Upholstery	Shipping														
COM Ydg	8 ¼	Ctn Wt	178												
COL Sq Ft	190	Cu Ft	75												
90° Curved Seat Low Back 	CTO32121 · 12" outside radius · 44" inside radius · COM based on single fabric · multiple fabrics, see pages 204-206 for yardage requirements · see pages 212-217 for application	<table border="1"> <thead> <tr> <th>Dimensions</th> <th>D</th> <th>W</th> <th>H</th> </tr> </thead> <tbody> <tr> <td>Overall</td> <td>32</td> <td></td> <td>30 ½</td> </tr> <tr> <td>Seat</td> <td>20</td> <td></td> <td>18</td> </tr> </tbody> </table>	Dimensions	D	W	H	Overall	32		30 ½	Seat	20		18	COM \$1,955 A \$2,021 B \$2,094 COL/C \$2,222 D \$2,387 E \$2,553 F \$2,809 G \$3,084 H \$3,377 I \$3,835 J \$4,385 L1 \$3,505 L2 \$3,890
		Dimensions	D	W	H										
Overall	32		30 ½												
Seat	20		18												
<table border="1"> <thead> <tr> <th>Upholstery</th> <th colspan="3">Shipping</th> </tr> </thead> <tbody> <tr> <td>COM Ydg</td> <td>3 ¾</td> <td>Ctn Wt</td> <td>98</td> </tr> <tr> <td>COL Sq Ft</td> <td>87</td> <td>Cu Ft</td> <td>36</td> </tr> </tbody> </table>	Upholstery	Shipping			COM Ydg	3 ¾	Ctn Wt	98	COL Sq Ft	87	Cu Ft	36			
Upholstery	Shipping														
COM Ydg	3 ¾	Ctn Wt	98												
COL Sq Ft	87	Cu Ft	36												

LOUNGE

Description	Model	Specifications				List Price Per Grade	
		Dimensions	D	W	H	COM	
90° Curved Seat Mid Back 	CT032122 • 12" outside radius • 44" inside radius • COM based on single fabric • multiple fabrics, see pages 204-206 for yardage requirements • see pages 212-217 for application	Overall	32		37½	COM	\$2,112
		Seat	20		18	A	\$2,186
		Upholstery		Shipping		B	\$2,268
		COM Ydg	4¼	Ctn Wt	103	COL/C	\$2,414
		COL Sq Ft	98	Cu Ft	46	D	\$2,601
						E	\$2,788
						F	\$3,079
						G	\$3,391
						H	\$3,723
						I	\$4,242
				J	\$4,865		
				L1	\$3,868		
				L2	\$4,304		
90° Curved Seat High Back 	CT032123 • 12" outside radius • 44" inside radius • 7" high headrest • COM based on single fabric • multiple fabrics, see pages 204-206 for yardage requirements • see pages 212-217 for application	Overall	32		44½	COM	\$2,270
		Seat	20		18	A	\$2,354
		Upholstery		Shipping		B	\$2,451
		COM Ydg	5	Ctn Wt	110	COL/C	\$2,622
		COL Sq Ft	115	Cu Ft	56	D	\$2,842
						E	\$3,061
						F	\$3,404
						G	\$3,770
						H	\$4,162
						I	\$4,772
				J	\$5,505		
				L1	\$4,332		
				L2	\$4,845		
90° Curved Seat Privacy Back 	CT032125 • 12" outside radius • 44" inside radius • 14" high headrest • COM based on single fabric • multiple fabrics, see pages 204-206 for yardage requirements • see pages 212-217 for application	Overall	32		51½	COM	\$2,427
		Seat	20		18	A	\$2,515
		Upholstery		Shipping		B	\$2,618
		COM Ydg	5¼	Ctn Wt	115	COL/C	\$2,798
		COL Sq Ft	121	Cu Ft	66	D	\$3,029
						E	\$3,260
						F	\$3,619
						G	\$4,003
						H	\$4,414
						I	\$5,055
				J	\$5,825		
				L1	\$4,593		
				L2	\$5,132		

To Order, Specify:

- 1 Model Number
- 2 Wood Species - Cherry (CH1), Maple (MA1) or Walnut (WA1)
- 3 Wood Finish
- 4 Laminate Color Selection (Stand up Surface)
- 5 Fabric Selection - vendor, pattern and color
 - A. Seat
 - B. Back
 - C. Headrest
- 6 Metal Leg Color - Black Sandtex (BSX), Soft Nickel (SNK) or Stardust Silver (STS)
- 7 Optional Power Center - Flush Mount (EC22) - Black (B) or White (W); \$504 list each, see page 201 for location availability
- 8 Product Options

3 Wood Finish Options:

- Cherry**
- | | |
|--------------|-------------|
| AUT Autumn | EAR Earthy |
| BRL Barley | LGC Legacy |
| BBN Bourbon | PRL Praline |
| BRG Brighton | SAF Saffron |
| CLA Classic | |
- Maple**
- | | |
|------------------|----------------|
| ALE Ale | FLX Flax ▲ |
| BUT Butterscotch | VEN Venetian ▲ |
| CIN Cinnamon | |
- Walnut**
- | | |
|---------------|-------------|
| AUB Auburn | TOF Toffee |
| ESP Espresso | TRF Truffle |
| MCH Mocha | SIE Sienna |
| NTO Night owl | |





4 Laminate Color Selection (Stand Up Surface)

- | | |
|--------------------|----------------|
| ALB Alabaster | SHD Shadow |
| BBL Bridal Blanco | SLG Slate Grey |
| DWH Designer White | TAU Taupe |
| DOV Dove Grey | |

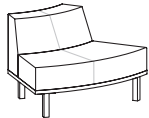

- 5 See a selection of graded in fabric manufacturers and patterns on pages 12-20. Contact Customer Service for additional fabric options.

Specifications

- Wood species - Cherry, Maple or Walnut.
- Seat has synthetic sheet webbing with cross strap reinforcement, 4¼" high density polyurethane foam.
- Back has high density polyurethane foam.
- Plywood construction with locking tenons, glue and screws.
- Linking bracket included.
- Metal legs are 16 gauge steel tube with metal leveling glides.
- ¾" thick 10" deep laminate stand up surface with coordinating 3mm PVC edge supported by steel columns, 42" surface height.

Description	① Model	Specifications				List Price Per Grade	
45° Curved Seat Low Back 	CT032301 · 30" outside radius · 62" inside radius · COM based on single fabric · multiple fabrics, see pages 204-206 for yardage requirements · see pages 212-217 for application	Dimensions		D	W	H	COM \$1,935
		Overall	32		30½		
		Seat	20		18		B \$2,052
		Upholstery		Shipping			COL/C \$2,155
		COM Ydg	3	Ctn Wt	90		D \$2,286
		COL Sq Ft	69	Cu Ft	27		E \$2,419
							F \$2,624
							G \$2,844
							H \$3,078
							I \$3,444
							J \$3,884
							L1 \$3,181
							L2 \$3,489
45° Curved Seat Mid Back 	CT032302 · 30" outside radius · 62" inside radius · COM based on single fabric · multiple fabrics, see pages 204-206 for yardage requirements · see pages 212-217 for application	Dimensions		D	W	H	COM \$2,092
		Overall	32		37½		
		Seat	20		18		B \$2,219
		Upholstery		Shipping			COL/C \$2,330
		COM Ydg	3¼	Ctn Wt	95		D \$2,473
		COL Sq Ft	75	Cu Ft	35		E \$2,616
							F \$2,839
							G \$3,077
							H \$3,331
							I \$3,728
							J \$4,205
							L1 \$3,442
							L2 \$3,775
45° Curved Seat High Back 	CT032303 · 30" outside radius · 62" inside radius · 7" high headrest · COM based on single fabric · multiple fabrics, see pages 204-206 for yardage requirements · see pages 212-217 for application	Dimensions		D	W	H	COM \$2,250
		Overall	32		44½		
		Seat	20		18		B \$2,401
		Upholstery		Shipping			COL/C \$2,538
		COM Ydg	4	Ctn Wt	102		D \$2,714
		COL Sq Ft	92	Cu Ft	42		E \$2,890
							F \$3,163
							G \$3,457
							H \$3,770
							I \$4,258
							J \$4,844
							L1 \$3,906
							L2 \$4,317
45° Curved Seat High Back 	CT032304 · 30" outside radius · 62" inside radius · 7" high headrest · 41¾" high stand up surface · COM based on single fabric · multiple fabrics, see pages 204-206 for yardage requirements · see pages 212-217 for application	Dimensions		D	W	H	COM \$3,113
		Overall	42		44½		
		Seat	20		18		B \$3,278
		Upholstery		Shipping			COL/C \$3,414
		COM Ydg	4	Ctn Wt	132		D \$3,590
		COL Sq Ft	92	Cu Ft	52		E \$3,766
							F \$4,040
							G \$4,333
							H \$4,646
							I \$5,134
							J \$5,721
							L1 \$4,782
							L2 \$5,193

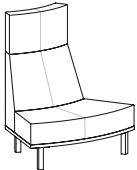
LOUNGE

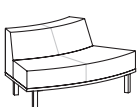
Description	Model	Specifications				List Price Per Grade	
		Dimensions	D	W	H	COM	
45° Curved Seat Privacy Back 	CT032305 • 30" outside radius • 62" inside radius • 14" high headrest • COM based on single fabric • multiple fabrics, see pages 204-206 for yardage requirements • see pages 212-217 for application	Overall	32		51 ½	COM	\$2,407
		Seat	20		18	A	\$2,486
		Upholstery		Shipping		B	\$2,569
		COM Ydg	4 ¼	Ctn Wt	107	COL/C	\$2,714
		COL Sq Ft	98	Cu Ft	50	D	\$2,901
						E	\$3,087
						F	\$3,378
						G	\$3,690
						H	\$4,022
						I	\$4,542
				J	\$5,164		
				L1	\$4,168		
				L2	\$4,604		
45° Curved Seat Privacy Back 	CT032306 • 30" outside radius • 62" inside radius • 14" high headrest • 41 ¾" high stand up surface • COM based on single fabric • multiple fabrics, see pages 204-206 for yardage requirements • see pages 212-217 for application	Overall	42		51 ½	COM	\$3,270
		Seat	20		18	A	\$3,362
		Upholstery		Shipping		B	\$3,444
		COM Ydg	4 ¼	Ctn Wt	137	COL/C	\$3,589
		COL Sq Ft	98	Cu Ft	60	D	\$3,777
						E	\$3,964
						F	\$4,254
						G	\$4,566
						H	\$4,899
						I	\$5,417
				J	\$6,040		
				L1	\$5,044		
				L2	\$5,479		
45° Curved Seat Low Back 	CT032451 • 45" outside radius • 77" inside radius • COM based on single fabric • multiple fabrics, see pages 204-206 for yardage requirements • see pages 212-217 for application	Overall	32		30 ½	COM	\$1,974
		Seat	20		18	A	\$2,044
		Upholstery		Shipping		B	\$2,123
		COM Ydg	4	Ctn Wt	101	COL/C	\$2,259
		COL Sq Ft	92	Cu Ft	34	D	\$2,434
						E	\$2,611
						F	\$2,885
						G	\$3,178
						H	\$3,491
						I	\$3,979
				J	\$4,565		
				L1	\$3,627		
				L2	\$4,038		

To Order, Specify:

- 1 Model Number
- 2 Wood Species - Cherry (CH1), Maple (MA1) or Walnut (WA1)
- 3 Wood Finish
- 4 Laminate Color Selection (Stand up Surface)
- 5 Fabric Selection - vendor, pattern and color
 - A. Seat
 - B. Back
 - C. Headrest
- 6 Metal Leg Color - Black Sandtex (BSX), Soft Nickel (SNK) or Stardust Silver (STS)
- 7 Optional Power Center - Flush Mount (EC22) - Black (B) or White (W); \$504 list each, see page 201 for location availability
- 8 Product Options

3 Wood Finish Options:

- Cherry**
- | | |
|--------------|-------------|
| AUT Autumn | EAR Earthy |
| BRL Barley | LGC Legacy |
| BBN Bourbon | PRL Praline |
| BRG Brighton | SAF Saffron |
| CLA Classic | |
- Maple**
- | | |
|------------------|----------------|
| ALE Ale | FLX Flax ▲ |
| BUT Butterscotch | VEN Venetian ▲ |
| CIN Cinnamon | |
- Walnut**
- | | |
|---------------|-------------|
| AUB Auburn | TOF Toffee |
| ESP Espresso | TRF Truffle |
| MCH Mocha | SIE Sienna |
| NTO Night owl | |



4 Laminate Color Selection (Stand Up Surface)

- | | |
|--------------------|----------------|
| ALB Alabaster | SHD Shadow |
| BBL Bridal Blanco | SLG Slate Grey |
| DWH Designer White | TAU Taupe |
| DOV Dove Grey | |

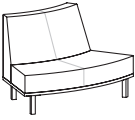

- 5 See a selection of graded in fabric manufacturers and patterns on pages 12-20. Contact Customer Service for additional fabric options.

Specifications

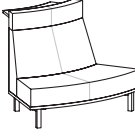
- Wood species - Cherry, Maple or Walnut.
- Seat has synthetic sheet webbing with cross strap reinforcement, 4 ¼" high density polyurethane foam.
- Back has high density polyurethane foam.
- Plywood construction with locking tenons, glue and screws.
- Linking bracket included.
- Metal legs are 16 gauge steel tube with metal leveling glides.
- ¾" thick 10" deep laminate stand up surface with coordinating 3mm PVC edge supported by steel columns, 42" surface height.

Description	① Model	Specifications				List Price Per Grade	
45° Curved Seat Mid Back 	CT032452 · 45" outside radius · 77" inside radius · COM based on single fabric · multiple fabrics, see pages 204-206 for yardage requirements · see pages 212-217 for application	Dimensions		D	W	H	COM \$2,132 A \$2,209 B \$2,297 COL/C \$2,450 D \$2,649 E \$2,846 F \$3,155 G \$3,484 H \$3,836 I \$4,385 J \$5,046 L1 \$3,989 L2 \$4,451
		Overall	32		37½		
		Seat	20		18		
		Upholstery		Shipping			
		COM Ydg	4½	Ctn Wt	106		
		COL Sq Ft	104	Cu Ft	44		
45° Curved Seat High Back 	CT032453 · 45" outside radius · 77" inside radius · 7" high headrest · COM based on single fabric · multiple fabrics, see pages 204-206 for yardage requirements · see pages 212-217 for application	Dimensions		D	W	H	COM \$2,289 A \$2,379 B \$2,486 COL/C \$2,674 D \$2,916 E \$3,158 F \$3,534 G \$3,937 H \$4,367 I \$5,039 J \$5,846 L1 \$4,555 L2 \$5,119
		Overall	32		44½		
		Seat	20		18		
		Upholstery		Shipping			
		COM Ydg	5½	Ctn Wt	113		
		COL Sq Ft	127	Cu Ft	54		
45° Curved Seat High Back 	CT032454 · 45" outside radius · 77" inside radius · 7" high headrest · 41¾" high stand up surface · COM based on single fabric · multiple fabrics, see pages 204-206 for yardage requirements · see pages 212-217 for application	Dimensions		D	W	H	COM \$3,173 A \$3,274 B \$3,383 COL/C \$3,570 D \$3,812 E \$4,055 F \$4,430 G \$4,834 H \$5,263 I \$5,935 J \$6,741 L1 \$5,452 L2 \$6,016
		Overall	42		44½		
		Seat	20		18		
		Upholstery		Shipping			
		COM Ydg	5½	Ctn Wt	143		
		COL Sq Ft	127	Cu Ft	64		

LOUNGE

Description	Model	Specifications	List Price Per Grade																																																		
45° Curved Seat Privacy Back 	CT032455 • 45" outside radius • 77" inside radius • 14" high headrest • COM based on single fabric • multiple fabrics, see pages 204-206 for yardage requirements • see pages 212-217 for application	<table border="1"> <thead> <tr> <th>Dimensions</th> <th>D</th> <th>W</th> <th>H</th> </tr> </thead> <tbody> <tr> <td>Overall</td> <td>32</td> <td></td> <td>51 ½</td> </tr> <tr> <td>Seat</td> <td>20</td> <td></td> <td>18</td> </tr> <tr> <th colspan="2">Upholstery</th> <th colspan="2">Shipping</th> </tr> <tr> <td>COM Ydg</td> <td>6</td> <td>Ctn Wt</td> <td>118</td> </tr> <tr> <td>COL Sq Ft</td> <td>138</td> <td>Cu Ft</td> <td>63</td> </tr> </tbody> </table>	Dimensions	D	W	H	Overall	32		51 ½	Seat	20		18	Upholstery		Shipping		COM Ydg	6	Ctn Wt	118	COL Sq Ft	138	Cu Ft	63	<table border="1"> <tbody> <tr><td>COM</td><td>\$2,447</td></tr> <tr><td>A</td><td>\$2,544</td></tr> <tr><td>B</td><td>\$2,660</td></tr> <tr><td>COL/C</td><td>\$2,866</td></tr> <tr><td>D</td><td>\$3,129</td></tr> <tr><td>E</td><td>\$3,393</td></tr> <tr><td>F</td><td>\$3,804</td></tr> <tr><td>G</td><td>\$4,244</td></tr> <tr><td>H</td><td>\$4,713</td></tr> <tr><td>I</td><td>\$5,446</td></tr> <tr><td>J</td><td>\$6,326</td></tr> <tr><td>L1</td><td>\$4,918</td></tr> <tr><td>L2</td><td>\$5,533</td></tr> </tbody> </table>	COM	\$2,447	A	\$2,544	B	\$2,660	COL/C	\$2,866	D	\$3,129	E	\$3,393	F	\$3,804	G	\$4,244	H	\$4,713	I	\$5,446	J	\$6,326	L1	\$4,918	L2	\$5,533
		Dimensions	D	W	H																																																
Overall	32		51 ½																																																		
Seat	20		18																																																		
Upholstery		Shipping																																																			
COM Ydg	6	Ctn Wt	118																																																		
COL Sq Ft	138	Cu Ft	63																																																		
COM	\$2,447																																																				
A	\$2,544																																																				
B	\$2,660																																																				
COL/C	\$2,866																																																				
D	\$3,129																																																				
E	\$3,393																																																				
F	\$3,804																																																				
G	\$4,244																																																				
H	\$4,713																																																				
I	\$5,446																																																				
J	\$6,326																																																				
L1	\$4,918																																																				
L2	\$5,533																																																				
45° Curved Seat Privacy Back 	CT032456 • 45" outside radius • 77" inside radius • 14" high headrest • 41 ¾" high stand up surface • COM based on single fabric • multiple fabrics, see pages 204-206 for yardage requirements • see pages 212-217 for application	<table border="1"> <thead> <tr> <th>Dimensions</th> <th>D</th> <th>W</th> <th>H</th> </tr> </thead> <tbody> <tr> <td>Overall</td> <td>42</td> <td></td> <td>51 ½</td> </tr> <tr> <td>Seat</td> <td>20</td> <td></td> <td>18</td> </tr> <tr> <th colspan="2">Upholstery</th> <th colspan="2">Shipping</th> </tr> <tr> <td>COM Ydg</td> <td>6</td> <td>Ctn Wt</td> <td>148</td> </tr> <tr> <td>COL Sq Ft</td> <td>138</td> <td>Cu Ft</td> <td>73</td> </tr> </tbody> </table>	Dimensions	D	W	H	Overall	42		51 ½	Seat	20		18	Upholstery		Shipping		COM Ydg	6	Ctn Wt	148	COL Sq Ft	138	Cu Ft	73	<table border="1"> <tbody> <tr><td>COM</td><td>\$3,330</td></tr> <tr><td>A</td><td>\$3,439</td></tr> <tr><td>B</td><td>\$3,557</td></tr> <tr><td>COL/C</td><td>\$3,762</td></tr> <tr><td>D</td><td>\$4,026</td></tr> <tr><td>E</td><td>\$4,290</td></tr> <tr><td>F</td><td>\$4,700</td></tr> <tr><td>G</td><td>\$5,140</td></tr> <tr><td>H</td><td>\$5,609</td></tr> <tr><td>I</td><td>\$6,342</td></tr> <tr><td>J</td><td>\$7,221</td></tr> <tr><td>L1</td><td>\$5,814</td></tr> <tr><td>L2</td><td>\$6,430</td></tr> </tbody> </table>	COM	\$3,330	A	\$3,439	B	\$3,557	COL/C	\$3,762	D	\$4,026	E	\$4,290	F	\$4,700	G	\$5,140	H	\$5,609	I	\$6,342	J	\$7,221	L1	\$5,814	L2	\$6,430
		Dimensions	D	W	H																																																
Overall	42		51 ½																																																		
Seat	20		18																																																		
Upholstery		Shipping																																																			
COM Ydg	6	Ctn Wt	148																																																		
COL Sq Ft	138	Cu Ft	73																																																		
COM	\$3,330																																																				
A	\$3,439																																																				
B	\$3,557																																																				
COL/C	\$3,762																																																				
D	\$4,026																																																				
E	\$4,290																																																				
F	\$4,700																																																				
G	\$5,140																																																				
H	\$5,609																																																				
I	\$6,342																																																				
J	\$7,221																																																				
L1	\$5,814																																																				
L2	\$6,430																																																				

To Order, Specify:

- 1 Model Number
- 2 Wood Species - Cherry (CH1), Maple (MA1) or Walnut (WA1)
- 3 Wood Finish
- 4 Laminate Color Selection (Stand up Surface)
- 5 Fabric Selection - vendor, pattern and color
 - A. Seat
 - B. Back
 - C. Headrest
- 6 Metal Leg Color - Black Sandtex (BSX), Soft Nickel (SNK) or Stardust Silver (STS)
- 7 Optional Power Center - Flush Mount (EC22) - Black (B) or White (W); \$504 list each, see page 201 for location availability
- 8 Product Options

3 Wood Finish Options:

- Cherry**
- | | | | |
|-----|----------|-----|---------|
| AUT | Autumn | EAR | Earthy |
| BRL | Barley | LGC | Legacy |
| BBN | Bourbon | PRL | Praline |
| BRG | Brighton | SAF | Saffron |
| CLA | Classic | | |
- Maple**
- | | | | |
|-----|--------------|-----|------------|
| ALE | Ale | FLX | Flax ▲ |
| BUT | Butterscotch | VEN | Venetian ▲ |
| CIN | Cinnamon | | |
- Walnut**
- | | | | |
|-----|-----------|-----|---------|
| AUB | Auburn | TOF | Toffee |
| ESP | Espresso | TRF | Truffle |
| MCH | Mocha | SIE | Sienna |
| NTO | Night owl | | |

4 Laminate Color Selection (Stand Up Surface)

- | | | | |
|-----|----------------|-----|------------|
| ALB | Alabaster | SHD | Shadow |
| BBL | Bridal Blanco | SLG | Slate Grey |
| DWH | Designer White | TAU | Taupe |
| DOV | Dove Grey | | |

- 5 See a selection of graded in fabric manufacturers and patterns on pages 12-20. Contact Customer Service for additional fabric options.

Specifications

- Wood species - Cherry, Maple or Walnut.
- Seat has synthetic sheet webbing with cross strap reinforcement, 4 ¼" high density polyurethane foam.
- Back has high density polyurethane foam.
- Plywood construction with locking tenons, glue and screws.
- Linking bracket included.
- Metal legs are 16 gauge steel tube with metal leveling glides.
- ¾" thick 10" deep laminate stand up surface with coordinating 3mm PVC edge supported by steel columns, 42" surface height.

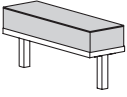
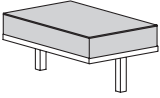
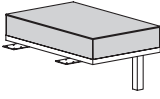
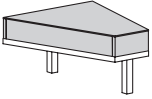
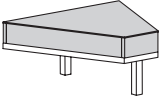
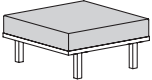
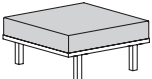
Description	D	W	H	CTN WT	CU FT	① Model	List Price
10" Linking Table  <ul style="list-style-type: none"> · attaches between lounge or bench units · wood top · wood chassis 	32	10	15	36	2	CTR3210CC	\$759
20" Linking Table  <ul style="list-style-type: none"> · attaches between lounge or bench units · wood top · wood chassis 	32	20	15	53	4	CTR3220CC	\$866
20" End Table  <ul style="list-style-type: none"> · attaches to end of lounge or bench unit · wood top · wood chassis 	32	20	15	58	10	CTR3220CE	\$913
10" - 30° Linking Table  <ul style="list-style-type: none"> · attaches between lounge or bench units to form a 30° connection · wood top · wood chassis 	32	10-26½	15	49	5	CTW30C	\$825
10" - 45° Linking Table  <ul style="list-style-type: none"> · attaches between lounge or bench units to form a 45° connection · wood top · wood chassis 	32	10-34½	15	56	7	CTW45C	\$843
Wood Table  <ul style="list-style-type: none"> · 32" square · wood top · wood chassis · straight grain 	32	32	15	78	9	CTS32WS	\$962
Wood Table  <ul style="list-style-type: none"> · 32" square · wood top · wood chassis · angled grain 	32	32	15	78	9	CTS32WA	\$962

LOUNGE

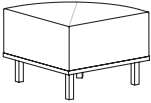
Description	① Model	Specifications				List Price Per Grade	
		Dimensions	D	W	H	COM	
Upholstered Quarter Round Table 	CTW90U · upholstered top · upholstered chassis · table height is same as arm height	Overall	32	32	24½	COM	\$1,113
		Upholstery		Shipping		COL/C	\$1,290
		COM Ydg	2½	Ctn Wt	69	D	\$1,399
		COL Sq Ft	58	Cu Ft	16	E	\$1,509
						F	\$1,680
						G	\$1,864
						H	\$2,060
						I	\$2,365
						J	\$2,732
						L1	\$2,145
						L2	\$2,401

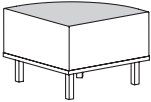
Description	① Model	Specifications				List Price Per Grade	
		Dimensions	D	W	H	COM	
Upholstered Quarter Round Table 	CTW90W · wood top · diagonal grain · upholstered chassis · table height is same as arm height	Overall	32	32	24½	COM	\$1,147
		Upholstery		Shipping		COL/C	\$1,260
		COM Ydg	1½	Ctn Wt	78	D	\$1,326
		COL Sq Ft	35	Cu Ft	16	E	\$1,392
						F	\$1,495
						G	\$1,605
						H	\$1,721
						I	\$1,905
						J	\$2,125
						L1	\$1,773
						L2	\$1,927

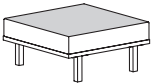
Description	① Model	Specifications				List Price Per Grade	
		Dimensions	D	W	H	COM	
Upholstered Table 	CTS32U · 32" square · wood top · upholstered chassis · freestanding application	Overall	32	32	15	COM	\$1,078
		Upholstery		Shipping		COL/C	\$1,158
		COM Ydg	1	Ctn Wt	78	D	\$1,202
		COL Sq Ft	23	Cu Ft	9	E	\$1,246
						F	\$1,314
						G	\$1,388
						H	\$1,466
						I	\$1,588
						J	\$1,735
						L1	\$1,500
						L2	\$1,603

To Order, Specify:

- ① Model Number
- ② Wood Species - Cherry (CH1), Maple (MA1) or Walnut (WA1)
- ③ Wood Finish
- ④ Fabric Selection - vendor, pattern and color
- ⑤ Metal Leg Color - Black Sandtex (BSX), Soft Nickel (SNK) or Stardust Silver (STS)
- ⑥ Optional Power Center - Flush Mount (EC22) - Black (B) or White (W); \$504 list each for linking or end tables
- ⑦ Optional Drink Holder(s) (DH) - add \$168 list for linking or end tables
- ▲ ⑧ Optional Coordinating Wood Grain Laminate Available on Table Tops - no upcharge. Finishes with an asterisk have a coordinating laminate available
- ⑨ Product Options

③ Wood Finish Options:

Cherry			
AUT	Autumn*	EAR	Earthy
BRL	Barley*	LGC	Legacy*
BBN	Bourbon*	PRL	Praline*
BRG	Brighton*	SAF	Saffron*
CLA	Classic*		
Maple			
ALE	Ale*	FLX	Flax ▲
BUT	Butterscotch	VEN	Venetian*▲
CIN	Cinnamon*		
Walnut			
AUB	Auburn*	TOF	Toffee*
ESP	Espresso	TRF	Truffle*
MCH	Mocha*	SIE	Sienna*
NTO	Night owl*		

- ④ See a selection of graded in fabric manufacturers and patterns on pages 12-20. Contact Customer Service for additional fabric options.

Specifications

- Wood species - Cherry, Maple or Walnut.
- Table has ¾" high density polyurethane foam.
- Plywood construction with locking tenons, glue and screws.
- Linking bracket included.
- Metal legs are 16 gauge steel tube with metal leveling glides.

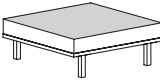
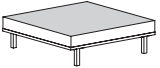
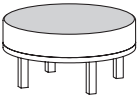
Description	① Model	Specifications				List Price Per Grade	
Upholstered Table 	CTS40U · 40" square · wood top · upholstered chassis · freestanding application	Dimensions		D	W	H	COM \$1,210
		Overall		40	40	15	A \$1,238
		Upholstery		Shipping			B \$1,258
		COM Ydg	1	Ctn Wt	85	COL/C \$1,292	
COL Sq Ft	23	Cu Ft	14	D \$1,336			
				E \$1,380			
				F \$1,448			
				G \$1,522			
				H \$1,600			
				I \$1,722			
				J \$1,868			
				L1 \$1,634			
				L2 \$1,737			
Upholstered Table 	CTS50U · 50" square · wood top · upholstered chassis · freestanding application	Dimensions		D	W	H	COM \$1,347
		Overall		50	50	15	A \$1,377
		Upholstery		Shipping			B \$1,397
		COM Ydg	1	Ctn Wt	92	COL/C \$1,431	
COL Sq Ft	23	Cu Ft	21	D \$1,475			
				E \$1,519			
				F \$1,587			
				G \$1,661			
				H \$1,738			
				I \$1,861			
				J \$2,007			
				L1 \$1,773			
				L2 \$1,876			
Table 	CTD30U · 30" diameter · wood top · upholstered chassis · freestanding application	Dimensions		D	W	H	COM \$1,923
		Overall		30		15	A \$1,962
		Upholstery		Shipping			B \$1,982
		COM Ydg	1	Ctn Wt	70	COL/C \$2,015	
COL Sq Ft	23	Cu Ft	10	D \$2,060			
				E \$2,104			
				F \$2,172			
				G \$2,245			
				H \$2,324			
				I \$2,446			
				J \$2,593			
				L1 \$2,358			
				L2 \$2,461			

LOUNGE

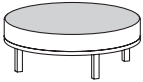
Description	Model	Specifications				List Price Per Grade	
		Dimensions	D	W	H	COM	
Table 	CTD42U · 42" diameter · wood top · upholstered chassis · freestanding application	Overall	42		15	COM	\$2,060
		Upholstery		Shipping			
		COM Ydg	1	Ctn Wt	79	A	\$2,100
		COL Sq Ft	23	Cu Ft	18	B	\$2,120
						COL/C	\$2,154
						D	\$2,198
						E	\$2,242
						F	\$2,310
						G	\$2,384
						H	\$2,463
						I	\$2,585
						J	\$2,732
						L1	\$2,496
						L2	\$2,599

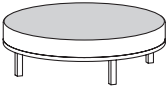
Description	Model	Specifications				List Price Per Grade	
		Dimensions	D	W	H	COM	
Table 	CTD50U · 50" diameter · wood top · upholstered chassis · freestanding application	Overall	50		15	COM	\$2,138
		Upholstery		Shipping			
		COM Ydg	1	Ctn Wt	90	A	\$2,180
		COL Sq Ft	23	Cu Ft	25	B	\$2,200
						COL/C	\$2,235
						D	\$2,278
						E	\$2,322
						F	\$2,390
						G	\$2,464
						H	\$2,543
						I	\$2,664
						J	\$2,811
						L1	\$2,576
						L2	\$2,679

To Order, Specify:

- 1 Model Number
- 2 Wood Species - Cherry (CH1), Maple (MA1) or Walnut (WA1)
- 3 Wood Finish
- 4 Fabric Selection - vendor, pattern and color
- 5 Metal Leg Color - Black Sandtex (BSX), Soft Nickel (SNK) or Stardust Silver (STS)
- 6 Optional Coordinating Wood Grain Laminate Available on Table Tops - no upcharge. Finishes with an asterisk have a coordinating laminate available
- 7 Product Options

3 Wood Finish Options:

- Cherry**
- | | |
|---------------|--------------|
| AUT Autumn* | EAR Earthy |
| BRL Barley* | LGC Legacy* |
| BBN Bourbon* | PRL Praline* |
| BRG Brighton* | SAF Saffron* |
| CLA Classic* | |
- Maple**
- | | |
|------------------|----------------|
| ALE Ale* | FLX Flax ▲ |
| BUT Butterscotch | VEN Venetian*▲ |
| CIN Cinnamon* | |
- Walnut**
- | | |
|----------------|--------------|
| AUB Auburn* | TOF Toffee* |
| ESP Espresso | TRF Truffle* |
| MCH Mocha* | SIE Sienna* |
| NTO Night owl* | |

Specifications

- Wood species - Cherry, Maple or Walnut.
- Plywood construction with locking tenons, glue and screws.
- Metal legs are 16 gauge steel tube with metal leveling glides.

4 See a selection of graded in fabric manufacturers and patterns on pages 12-20. Contact Customer Service for additional fabric options.

Description	D	W	H	CTN WT	CU FT	① Model	List Price
Wood Table	40	40	15	85	14	CTS40W	\$1,038

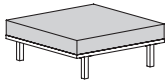

- 40" square
- wood top
- wood chassis
- freestanding application

Wood Table	50	50	15	92	21	CTS50W	\$1,185
------------	----	----	----	----	----	--------	---------

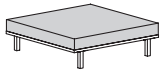

- 50" square
- wood top
- wood chassis
- freestanding application

Table	30	15	81	10	CTD30W	\$1,897
-------	----	----	----	----	--------	---------



- 30" diameter
- wood top
- wood chassis
- freestanding application

Table	42	15	90	18	CTD42W	\$2,167
-------	----	----	----	----	--------	---------

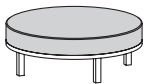

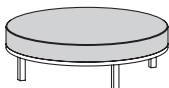

- 42" diameter
- wood top
- wood chassis
- freestanding application

Table	50	15	103	25	CTD50W	\$2,513
-------	----	----	-----	----	--------	---------

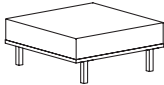
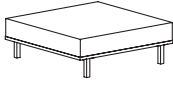

- 50" diameter
- wood top
- wood chassis
- freestanding application

LOUNGE

Description	① Model	Specifications				List Price Per Grade		
Ottoman 	CTS400 · 40" square · fully upholstered · freestanding application	Dimensions		D	W	H	COM \$1,276	
		Overall		40	40	18	A	\$1,320
		Seat		40	40	18	B	\$1,370
		Upholstery		Shipping			COL/C	\$1,455
		COM Ydg		2 ½	Ctn Wt	80	D	\$1,565
		COL Sq Ft		58	Cu Ft	17	E	\$1,674
							F	\$1,845
							G	\$2,029
							H	\$2,224
							I	\$2,530
Ottoman 	CTS500 · 50" square · fully upholstered · freestanding application	Dimensions		D	W	H	COM \$1,337	
		Overall		50	50	18	A	\$1,382
		Seat		50	50	18	B	\$1,431
		Upholstery		Shipping			COL/C	\$1,517
		COM Ydg		2 ½	Ctn Wt	87	D	\$1,627
		COL Sq Ft		58	Cu Ft	25	E	\$1,736
							F	\$1,907
							G	\$2,091
							H	\$2,286
							I	\$2,592
Ottoman 	CTD300 · 30" diameter · fully upholstered · freestanding application	Dimensions		D	W	H	COM \$1,745	
		Overall		30		15	A	\$1,793
		Upholstery		Shipping			B	\$1,837
		COM Ydg		2 ¼	Ctn Wt	65	COL/C	\$1,915
		COL Sq Ft		52	Cu Ft	10	D	\$2,013
							E	\$2,112
							F	\$2,266
							G	\$2,431
							H	\$2,607
							I	\$2,882

LOUNGE

To Order, Specify:

- ① Model Number
- ② Wood Species - Cherry (CH1), Maple (MA1) or Walnut (WA1)
- ③ Wood Finish
- ④ Fabric Selection - vendor, pattern and color
- ⑤ Metal Color - Black Sandtex (BSX), Soft Nickel (SNK) or Stardust Silver (STS)
- ▲ ⑥ Optional Coordinating Wood Grain Laminate Available on Table Tops - no upcharge. Finishes with an asterisk have a coordinating laminate available
- ⑦ Product Options

③ Wood Finish Options:

Cherry		AUT	Autumn*	EAR	Earthy
BRL	Barley*	LGC	Legacy*	PRL	Praline*
BBN	Bourbon*	SAF	Saffron*		
BRG	Brighton*				
CLA	Classic*				
Maple		ALE	Ale*	FLX	Flax ▲
BUT	Butterscotch	VEN	Venetian* ▲		
CIN	Cinnamon*				
Walnut		AUB	Auburn*	TOF	Toffee*
ESP	Espresso	TRF	Truffle*	SIE	Sienna*
MCH	Mocha*				
NTO	Night owl*				

Specifications

- Wood species - Cherry, Maple or Walnut.
- Ottomans have 2" high density polyurethane foam.
- Plywood construction with locking tenons, glue and screws.
- Metal legs are 16 gauge steel tube with metal leveling glides.

④ See a selection of graded in fabric manufacturers and patterns on pages 12-20. Contact Customer Service for additional fabric options.

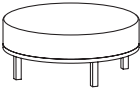
Description	① Model	Specifications				List Price Per Grade	
Ottoman 	CTD420 · 42" diameter · fully upholstered · freestanding application	Dimensions		D	W	H	COM \$1,823
		Overall		42		15	A \$1,876
		Upholstery		Shipping			B \$1,924
		COM Ydg	2 ½	Ctn Wt	74	COL/C \$2,010	
		COL Sq Ft	58	Cu Ft	18	D \$2,120	
				E \$2,230			
				F \$2,401			
				G \$2,585			
				H \$2,780			
				I \$3,085			
				J \$3,452			
				L1 \$2,865			
				L2 \$3,122			

Description	① Model	Specifications				List Price Per Grade	
Ottoman 	CTD500 · 50" diameter · fully upholstered · freestanding application	Dimensions		D	W	H	COM \$1,902
		Overall		50		15	A \$1,958
		Upholstery		Shipping			B \$2,012
		COM Ydg	2 ¾	Ctn Wt	84	COL/C \$2,106	
		COL Sq Ft	64	Cu Ft	25	D \$2,226	
				E \$2,347			
				F \$2,536			
				G \$2,738			
				H \$2,952			
				I \$3,288			
				J \$3,691			
				L1 \$3,047			
				L2 \$3,329			

Description	D	W	H	CTN WT	CU FT	① Model	List Price
Magazine Table	48	48	15	202	30	CT4848-15	\$2,518

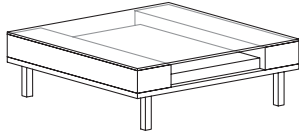

- glass top
- freestanding application

Magazine Table	42	42	15	173	21	CT4242-15	\$2,347
----------------	----	----	----	-----	----	-----------	---------

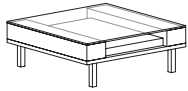

- glass top
- freestanding application

Magazine Table	36	36	15	145	16	CT3636-15	\$2,219
----------------	----	----	----	-----	----	-----------	---------

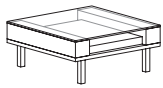

- glass top
- freestanding application

Magazine Table	24	48	15	137	15	CT2448-15	\$2,193
----------------	----	----	----	-----	----	-----------	---------

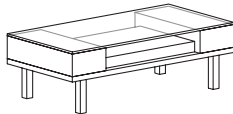

- glass top
- freestanding application

End Table	32	32	22	134	18	CT3232-22	\$2,103
-----------	----	----	----	-----	----	-----------	---------

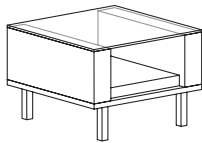

- glass top
- freestanding application

Sofa Table	18	60	28	182	25	CT1860-28	\$3,064
------------	----	----	----	-----	----	-----------	---------

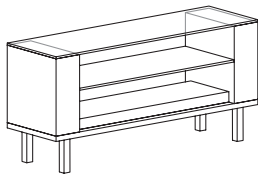

- glass top and shelf
- freestanding application

To Order, Specify:

- ① Model Number
- ② Wood Species - Cherry (CH1), Maple (MA1) or Walnut (WA1)
- ③ Wood Finish
- ④ Fabric Selection - vendor, pattern and color
- ⑤ Metal Color - Black Sandtex (BSX), Soft Nickel (SNK) or Stardust Silver (STS)
- ⑥ Product Options

③ Wood Finish Options:

Cherry			
AUT	Autumn	EAR	Earthy
BRL	Barley	LGC	Legacy
BBN	Bourbon	PRL	Praline
BRG	Brighton	SAF	Saffron
CLA	Classic		
Maple			
ALE	Ale	FLX	Flax ▲
BUT	Butterscotch	VEN	Venetian ▲
CIN	Cinnamon		
Walnut			
AUB	Auburn	TOF	Toffee
ESP	Espresso	TRF	Truffle
MCH	Mocha	SIE	Sienna
NTO	Night owl		

Specifications

- Wood species - Cherry, Maple or Walnut.
- Ottomans have 2" high density polyurethane foam.
- Plywood construction with locking tenons, glue and screws.
- Metal legs are 16 gauge steel tube with metal leveling glides.

- ④ See a selection of graded in fabric manufacturers and patterns on pages 12-20. Contact Customer Service for additional fabric options.

Description	D	W	H	CTN WT	CU FT	① Model	List Price
Pull Up Table	17	17	27	15	3	CT1717LTT	\$901

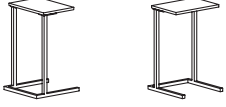

- 3/4" top thickness
- 12" top depth

Media Cabinet	20	60	25	140	22	CT2060M	\$1,756
----------------------	----	----	----	-----	----	----------------	---------

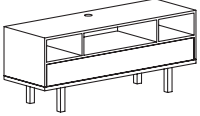

- one surface grommet
- lower hinged access panel

Media Cabinet	20	60	25	140	22	CT2060MAS	\$2,048
----------------------	----	----	----	-----	----	------------------	---------

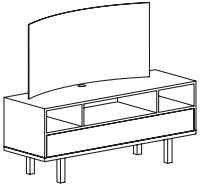

- acrylic screen
- one surface grommet
- lower hinged access panel

Media Cabinet	20	60	25	130	23	CT2060MC	\$1,746
----------------------	----	----	----	-----	----	-----------------	---------

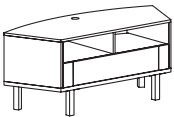

- 45 degree radius
- 77" outside radius
- 24 5/8" deep at deepest point
- 45" front width
- one surface grommet
- lower hinged access panel

Media Cabinet	20	60	25	130	23	CT2060MCAS	\$2,037
----------------------	----	----	----	-----	----	-------------------	---------

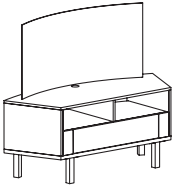

- acrylic screen
- 45 degree radius
- 77" outside radius
- 24 5/8" deep at deepest point
- 45" front width
- one surface grommet
- lower hinged access panel

Media Activity Center	84	60	29	335	40	CT6084MACB	\$3,205
------------------------------	----	----	----	-----	----	-------------------	---------

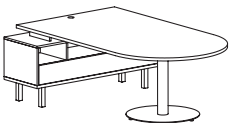

- bullet shape top
- one surface grommet
- base has a 4" diameter column with 24" diameter disc
- R3 edge on worksurface
- top thickness 1 3/16"
- worksurface height 29"
- media cabinet included

Media Activity Center	72	60	29	310	39	CT6072MACB	\$3,086
------------------------------	----	----	----	-----	----	-------------------	---------

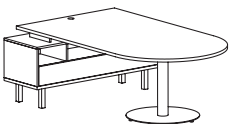

- bullet shape top
- one surface grommet
- base has a 4" diameter column with 24" diameter disc
- R3 edge on worksurface
- top thickness 1 3/16"
- worksurface height 29"
- media cabinet included

LOUNGE

Description	D	W	H	CTN WT	CU FT	① Model	List Price
Media Activity Center	84	60	29	344	40	CT6084MACR	\$3,411

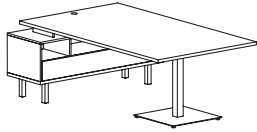

- rectangular shape top
- one surface grommet
- base has a 3" x 3" square column with an 18" x 18" square base
- R3 edge on worksurface
- top thickness 1 3/16"
- worksurface height 29"
- media cabinet included

Media Activity Center	72	60	29	319	39	CT6072MACR	\$3,292
------------------------------	----	----	----	-----	----	-------------------	----------------

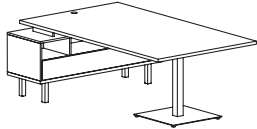

- rectangular shape top
- one surface grommet
- base has a 3" x 3" square column with an 18" x 18" square base
- R3 edge on worksurface
- top thickness 1 3/16"
- worksurface height 29"
- media cabinet included

Media Activity Center	84	60	29	350	40	CT6084MACBW	\$3,887
------------------------------	----	----	----	-----	----	--------------------	----------------

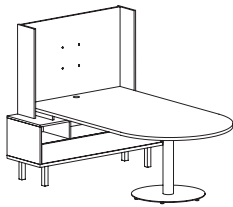

- bullet shape top
- one surface grommet
- base has a 4" diameter column with 24" diameter disc
- R3 edge on worksurface
- top thickness 1 3/16"
- worksurface height 29"
- back wall panel is 31" high from top of worksurface to top of panel
- back wall panel is 48" wide, from inside panel to inside panel
- back wall ships KD
- media cabinet and TV mount included
- TV not included

Media Activity Center	72	60	29	325	29	CT6072MACBW	\$3,768
------------------------------	----	----	----	-----	----	--------------------	----------------

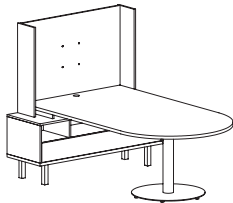

- bullet shape top
- one surface grommet
- base has a 4" diameter column with 24" diameter disc
- R3 edge on worksurface
- top thickness 1 3/16"
- worksurface height 29"
- back wall panel is 31" high from top of worksurface to top of panel
- back wall panel is 48" wide, from inside panel to inside panel
- back wall ships KD
- media cabinet and TV mount included
- TV not included

To Order, Specify:

- ① Model Number
- ② Wood Species - Cherry (CH1), Maple (MA1) or Walnut (WA1)
- ③ Wood Finish
- ④ Metal Leg Color - Black Sandtex (BSX), Soft Nickel (SNK) or Stardust Silver (STS)
- ▲ ⑤ Optional Coordinating Wood Grain Laminate Available on Main Horizontal Surface - no upcharge. Finishes with an asterisk have a coordinating laminate available
- ⑥ Product Options

③ Wood Finish Options:

Cherry		AUT	Autumn*	EAR	Earthy
BRL	Barley*	LGC	Legacy*	PRL	Praline*
BBN	Bourbon*	SAF	Saffron*		
BRG	Brighton*				
CLA	Classic*				
Maple		ALE	Ale*	FLX	Flax ▲
BUT	Butterscotch	VEN	Venetian* ▲		
CIN	Cinnamon*				
Walnut		AUB	Auburn*	TOF	Toffee*
ESP	Espresso	TRF	Truffle*	SIE	Sienna*
MCH	Mocha*				
NTO	Night owl*				

Specifications

- Wood species - Cherry, Maple or Walnut.
- Plywood construction with locking tenons, glue and screws.
- Linking bracket included.
- Metal legs are 16 gauge steel tube with metal leveling glides.

- ④ See a selection of graded in fabric manufacturers and patterns on pages 12-20. Contact Customer Service for additional fabric options.

Description	D	W	H	CTN WT	CU FT	① Model	List Price
Media Activity Center	84	60	29	359	40	CT6084MACRW	\$3,974

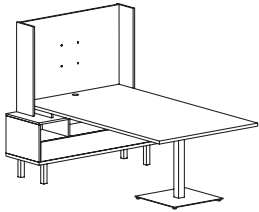

- rectangular shape top
- one surface grommet
- base has a 3" x 3" square column with an 18" x 18" square base
- R3 edge on worksurface
- top thickness 1 3/16"
- worksurface height 29"
- back wall panel is 31" high from top of worksurface to top of panel
- back wall panel is 48" wide, from inside panel to inside panel
- back wall ships KD
- media cabinet and TV mount included

Media Activity Center	72	60	29	329	39	CT6072MACRW	\$3,974
-----------------------	----	----	----	-----	----	-------------	---------

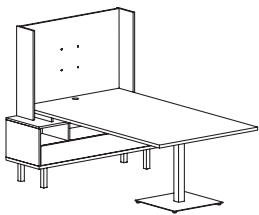

- rectangular shape top
- one surface grommet
- base has a 3" x 3" square column with an 18" x 18" square base
- R3 edge on worksurface
- top thickness 1 3/16"
- worksurface height 29"
- back wall panel is 31" high from top of worksurface to top of panel
- back wall panel is 48" wide, from inside panel to inside panel
- back wall ships KD
- media cabinet and TV mount included

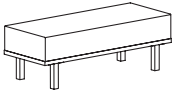
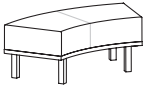
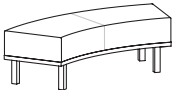
Description	Model	Specifications	List Price Per Grade															
Media Bench 	CTR20500 · used with media cabinet	<table border="1"> <thead> <tr> <th>Dimensions</th> <th>D</th> <th>W</th> <th>H</th> </tr> </thead> <tbody> <tr> <td>Overall</td> <td>20</td> <td>50</td> <td>18</td> </tr> <tr> <td>Seat</td> <td>20</td> <td>50</td> <td></td> </tr> </tbody> </table>	Dimensions	D	W	H	Overall	20	50	18	Seat	20	50		COM \$1,147 A \$1,180 B \$1,209 COL/C \$1,260 D \$1,326 E \$1,392 F \$1,495 G \$1,605 H \$1,721 I \$1,905 J \$2,125 L1 \$1,773 L2 \$1,927			
		Dimensions	D	W	H													
		Overall	20	50	18													
		Seat	20	50														
		<table border="1"> <thead> <tr> <th>Upholstery</th> <th colspan="3">Shipping</th> </tr> </thead> <tbody> <tr> <td>COM Ydg</td> <td>1 ½</td> <td>Ctn Wt</td> <td>52</td> </tr> <tr> <td>COL Sq Ft</td> <td>35</td> <td>Cu Ft</td> <td>11</td> </tr> </tbody> </table>	Upholstery	Shipping			COM Ydg	1 ½	Ctn Wt	52	COL Sq Ft	35	Cu Ft	11				
		Upholstery	Shipping															
		COM Ydg	1 ½	Ctn Wt	52													
		COL Sq Ft	35	Cu Ft	11													
		Curved Media Bench 	CTI20420 · 45 degree · 42" inside radius · 62" outside radius · used with media cabinet	<table border="1"> <thead> <tr> <th>Dimensions</th> <th>D</th> <th>W</th> <th>H</th> </tr> </thead> <tbody> <tr> <td>Overall</td> <td>20</td> <td></td> <td>18</td> </tr> <tr> <td>Seat</td> <td>20</td> <td></td> <td></td> </tr> </tbody> </table>	Dimensions	D	W	H	Overall	20		18	Seat	20				COM \$1,360 A \$1,398 B \$1,433 COL/C \$1,493 D \$1,569 E \$1,646 F \$1,766 G \$1,895 H \$2,031 I \$2,245 J \$2,502 L1 \$2,091 L2 \$2,271
				Dimensions	D	W	H											
Overall	20				18													
Seat	20																	
<table border="1"> <thead> <tr> <th>Upholstery</th> <th colspan="3">Shipping</th> </tr> </thead> <tbody> <tr> <td>COM Ydg</td> <td>1 ¾</td> <td>Ctn Wt</td> <td>51</td> </tr> <tr> <td>COL Sq Ft</td> <td>41</td> <td>Cu Ft</td> <td>12</td> </tr> </tbody> </table>	Upholstery			Shipping			COM Ydg	1 ¾	Ctn Wt	51	COL Sq Ft	41	Cu Ft	12				
Upholstery	Shipping																	
COM Ydg	1 ¾			Ctn Wt	51													
COL Sq Ft	41			Cu Ft	12													
Curved Media Bench 	CTI20570 · 45 degree · 57" inside radius · 77" outside radius · used with media cabinet			<table border="1"> <thead> <tr> <th>Dimensions</th> <th>D</th> <th>W</th> <th>H</th> </tr> </thead> <tbody> <tr> <td>Overall</td> <td>20</td> <td></td> <td>18</td> </tr> <tr> <td>Seat</td> <td>20</td> <td></td> <td></td> </tr> </tbody> </table>	Dimensions	D	W	H	Overall	20		18	Seat	20			COM \$1,370 A \$1,411 B \$1,449 COL/C \$1,518 D \$1,606 E \$1,694 F \$1,831 G \$1,978 H \$2,134 I \$2,378 J \$2,671 L1 \$2,202 L2 \$2,407	
				Dimensions	D	W	H											
		Overall	20		18													
		Seat	20															
		<table border="1"> <thead> <tr> <th>Upholstery</th> <th colspan="3">Shipping</th> </tr> </thead> <tbody> <tr> <td>COM Ydg</td> <td>2</td> <td>Ctn Wt</td> <td>54</td> </tr> <tr> <td>COL Sq Ft</td> <td>46</td> <td>Cu Ft</td> <td>16</td> </tr> </tbody> </table>	Upholstery	Shipping			COM Ydg	2	Ctn Wt	54	COL Sq Ft	46	Cu Ft	16				
		Upholstery	Shipping															
		COM Ydg	2	Ctn Wt	54													
		COL Sq Ft	46	Cu Ft	16													

LOUNGE

To Order, Specify:

- 1 Model Number
- 2 Wood Species - Cherry (CH1), Maple (MA1) or Walnut (WA1)
- 3 Wood Finish
- 4 Fabric Selection - vendor, pattern and color
- 5 Metal Leg Color - Black Sandtex (BSX), Soft Nickel (SNK) or Stardust Silver (STS)
- 6 Optional Coordinating Wood Grain Laminate Available on Worksurface - no upcharge. Finishes with an asterisk have a coordinating laminate available
- 7 Product Options

3 Wood Finish Options:

- Cherry**
- | | |
|---------------|--------------|
| AUT Autumn* | EAR Earthy |
| BRL Barley* | LGC Legacy* |
| BBN Bourbon* | PRL Praline* |
| BRG Brighton* | SAF Saffron* |
| CLA Classic* | |
- Maple**
- | | |
|------------------|----------------|
| ALE Ale* | FLX Flax▲ |
| BUT Butterscotch | VEN Venetian*▲ |
| CIN Cinnamon* | |
- Walnut**
- | | |
|----------------|--------------|
| AUB Auburn* | TOF Toffee* |
| ESP Espresso | TRF Truffle* |
| MCH Mocha* | SIE Sienna* |
| NTO Night owl* | |

Specifications

- Wood species - Cherry, Maple or Walnut.
- Seat has synthetic sheet webbing with cross strap reinforcement, 4 ¼" high density polyurethane foam.
- Plywood construction with locking tenons, glue and screws.
- Linking bracket included.
- Metal legs are 16 gauge steel tube with metal leveling glides.

4 See a selection of graded in fabric manufacturers and patterns on pages 12-20. Contact Customer Service for additional fabric options.

Description	D	W	H	CTN WT	CU FT	Model	List Price
Power Center Under Mount	6	3 5/8	2 1/2	4	1	EC21	\$450

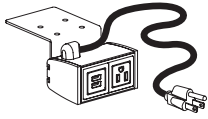

- mounts under platform or surface
- field installable
- one power receptacle - 110 volt, one dual USB port
- 10' power cord with molded plug
- specify Black (B) or White (W) finish

DropShare	5 1/2	8 1/2	3 1/2	5	3	DROP12	\$4,548
------------------	-------	-------	-------	---	---	---------------	----------------

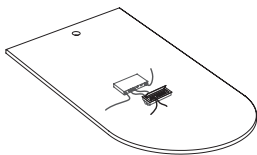

- used in Media Activity Center
- mounts in pre-determined standard location
- single sided unit with (2) receptacles and (2) Drop Share cords
- cord extends 48" from grommet in worksurface
- 6' power cord for receptacles
- control module mounts under worksurface
- module includes transformer with 6' power cord and (1) HDMI output for connection to monitor
- HDMI cable not included
- silver finish

DropShare	5 1/2	11 1/2	3 1/2	5	3	DROP14	\$6,286
------------------	-------	--------	-------	---	---	---------------	----------------

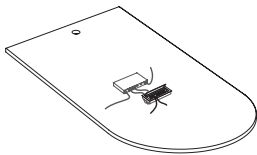

- used in Media Activity Center
- mounts in pre-determined standard location
- single sided unit with (2) receptacles and (4) Drop Share cords
- cord extends 48" from grommet in worksurface
- 6' power cord for receptacles
- control module mounts under worksurface
- module includes transformer with 6' power cord and (1) HDMI output for connection to monitor
- HDMI cable not included
- silver finish

DropShare	8 1/2	10 1/2	3 1/2	7	3	DROP24	\$6,750
------------------	-------	--------	-------	---	---	---------------	----------------

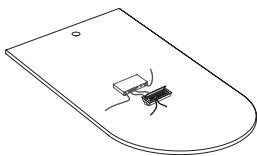

- used in Media Activity Center
- mounts in pre-determined standard location
- dual sided unit with (4) receptacles and (4) Drop Share cords
- cord extends 48" from grommet in worksurface
- 6' power cord for receptacles
- control module mounts under worksurface
- module includes transformer with 6' power cord and (1) HDMI output for connection to monitor
- HDMI cable not included
- silver finish

LOUNGE

Description	D	W	H	CTN WT	CU FT	① Model	List Price
Mini Power and Data Tilt Up	4 ¼	5 ½		6	1	EC10	\$352



- fluid one touch tilt up access
- one power receptacle - 120 volt; 15 amp and one voice/data port adapter to accept most jack manufacturers
- 72" power cord with molded plug
- drop in field installation required
- UL listed component
- available in Silver finish
- cut out provided in Media Activity Center at specified location

Mini Power Tilt Up	4 ¼	5 ½		6	1	EC11	\$367
---------------------------	-----	-----	--	---	---	-------------	--------------



- fluid one touch tilt up access
- two power receptacles - 120 volt; 15 amp
- 72" power cord with molded plug
- drop in field installation required
- UL listed component
- available in Silver finish
- cut out provided in Media Activity Center at specified location

Mini Power and USB Tilt Up	4 ¼	5 ½		6	1	EC12	\$458
-----------------------------------	-----	-----	--	---	---	-------------	--------------



- fluid one touch tilt up access
- one power receptacle - 120 volt; 15 amp dual powered USB
- 72" power cord with molded plug
- drop in field installation required
- UL listed component
- available in Silver finish
- cut out provided in Media Activity Center at specified location

To Order, Specify:

① Model Number

Corbin Lounge Order Check List:



Specify:

- 1. Model Number
- 2. Wood Species - Maple (M)
- 3. Wood Finish
- 4. Fabric Selection - vendor, pattern and color
- 5. Optional Rubber Cushion Nylon Glides - no upcharge
WOOD LEG MODELS ONLY

Example:

CB7501S | M | AUB | MOMENTUM | VOX | MYSTIC
(model #) | (wood species) | (finish) | (fabric vendor) | (pattern name) | (pattern color)

1. Model Number

2. Wood Species - Maple (M)

3. Wood Finish Options: ▲

ALE	Ale	FLX	Flax
AUB	Auburn	CGR	Graphite Coordinate
AUT	Autumn	CHL	High Line Coordinate
BRL	Barley	CKC	Khaki Coordinate
CBE	Blonde Echo Coordinate	LGC	Legacy
BBN	Bourbon	MCH	Mocha
CBZ	Brazilwood Coordinate	NTO	Night Owl
BRG	Brighton	PRL	Praline
BUT	Butterscotch	SAF	Saffron
CIN	Cinnamon	SIE	Sienna
CLA	Classic	CST	Studio Teak Coordinate
CCF	Coffee Coordinate	TOF	Toffee
CCR	Cremello Coordinate	TRF	Truffle
EAR	Earthy	VEN	Venetian
ESP	Espresso	CWH	Walnut Heights Coordinate

4. Fabric Selection - Please supply the following:

- Fabric vendor
- Pattern name
- Pattern color

When specifying contrasting upholstery, indicate clearly which upholstery is to be applied to the seat, back and arms. Use higher grade pricing.

- Indicate direction of fabric - Railroaded or Up the Roll
- Please provide illustration, if available

All COM orders must include the following:

- Vendor's name, pattern name and color
- Sample of the fabric attached to order
- Model numbers of items for fabric application
- Special application instructions (e.g., all stripes will be applied front to back unless specified otherwise)
- Customer and purchase order number

Ship prepaid COM material to:
JSI
Attn: COM Dept
932 Mill Street
Jasper, IN 47546

Application of fabric:
Railroaded Up the Roll

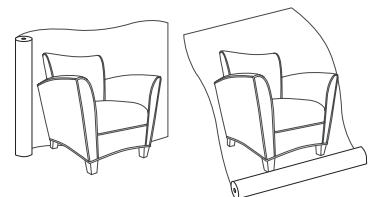

All COM orders will ship at standard lead time from receipt of COM except for orders requiring special custom matched finishes.

**5. Optional Rubber Cushion Nylon Glides - no upcharge
WOOD LEG MODELS ONLY**

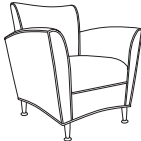
Description	Model	Specifications				List Price Per Grade	
		Dimensions	D	W	H	COM	
Single Seat <i>NOW!</i> 	CB7501W · wood leg	Overall	32	34	35	A	\$1,756
		Seat	22	20	18	B	\$1,952
	CB7501S · Matte Nickel metal leg	Arm			28	COL/C	\$2,180
		Upholstery		Shipping		D	\$2,473
		COM Ydg	7 1/2	Ctn Wt	74	E	\$2,767
		COL Sq Ft	173	Cu Ft	27	F	\$3,076
						G	\$3,516
						H	\$3,985
						I	\$4,718
						J	\$5,598
						L1	\$4,190
						L2	\$4,806

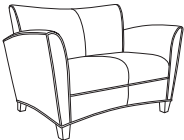
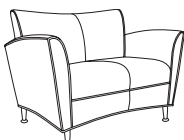
Description	Model	Specifications				List Price Per Grade	
		Dimensions	D	W	H	COM	
Two Seat <i>NOW!</i> 	CB7502W · wood leg	Overall	32	54	35	A	\$2,396
		Seat	22	40	18	B	\$2,683
	CB7502S · Matte Nickel metal leg	Arm			28	COL/C	\$3,018
		Upholstery		Shipping		D	\$3,448
		COM Ydg	11	Ctn Wt	93	E	\$3,878
		COL Sq Ft	253	Cu Ft	45	F	\$4,332
						G	\$4,976
						H	\$5,664
						I	\$6,739
						J	\$8,030
						L1	\$5,966
						L2	\$6,869

To Order, Specify:

- 1 Model Number
- 2 Wood Species - Maple (M)
- 3 Wood Finish
- 4 Fabric Selection - vendor, pattern and color
- 5 Optional Rubber Cushion Nylon Glides - no upcharge
WOOD LEG MODELS ONLY

3 Wood Finish Options:▲

ALE Ale	FLX Flax
AUB Auburn	CGR Graphite Coordinate
AUT Autumn	CHL High Line Coordinate
BRL Barley	CKC Khaki Coordinate
CBE Blonde Echo Coordinate	LGC Legacy
BBN Bourbon	MCH Mocha
CBZ Brazilwood Coordinate	NTO Night Owl
BRG Brighton	PRL Praline
BUT Butterscotch	SAF Saffron
CIN Cinnamon	SIE Sienna
CLA Classic	CST Studio Teak Coordinate
CCF Coffee Coordinate	TOF Toffee
CCR Cremello Coordinate	TRF Truffle
EAR Earthy	VEN Venetian
ESP Espresso	CWH Walnut Heights Coordinate





Specifications

- Wood species - Maple.
- 7/8" thick furniture-grade plywood construction.
- Seat has 6" polyurethane foam with Dacron® wrap and synthetic sheet webbing with cross strap reinforcement.
- Back has 4 1/2" polyurethane foam with synthetic sheet webbing suspension.
- Wood leg comes standard with rubber cushion metal glides (wood leg models only). Metal leg comes with stainless steel nylon glides.▲

When ordering Quickship products, place a "Q" in front of model number.
Example: QGT4901D

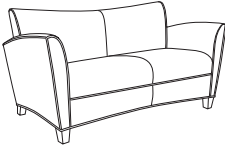
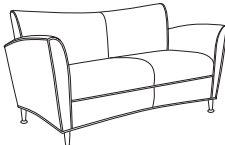
Need it.
JSI Quickship

- 4 See a selection of graded in fabric manufacturers and patterns on pages 12-20. Contact Customer Service for additional fabric options.

Description	① Model	Specifications				List Price Per Grade																
Three Seat   	CB7503W · wood leg	<table border="1"> <thead> <tr> <th>Dimensions</th> <th>D</th> <th>W</th> <th>H</th> </tr> </thead> <tbody> <tr> <td>Overall</td> <td>32</td> <td>74</td> <td>35</td> </tr> <tr> <td>Seat</td> <td>22</td> <td>60</td> <td>18</td> </tr> <tr> <td>Arm</td> <td colspan="3">28</td> </tr> </tbody> </table>	Dimensions	D	W	H	Overall	32	74	35	Seat	22	60	18	Arm	28						COM \$2,666 A \$2,781 B \$3,007 COL/C \$3,401 D \$3,910 E \$4,418 F \$4,954 G \$5,717 H \$6,529 I \$7,800 J \$9,324 L1 \$6,885 L2 \$7,952
	Dimensions	D	W	H																		
Overall	32	74	35																			
Seat	22	60	18																			
Arm	28																					
CB7503S · Matte Nickel metal leg																						
Ottoman   	CB7504W · wood leg	<table border="1"> <thead> <tr> <th>Dimensions</th> <th>D</th> <th>W</th> <th>H</th> </tr> </thead> <tbody> <tr> <td>Overall</td> <td>19</td> <td>22</td> <td>17</td> </tr> </tbody> </table>	Dimensions	D	W	H	Overall	19	22	17				COM \$871 A \$893 B \$937 COL/C \$1,013 D \$1,110 E \$1,208 F \$1,311 G \$1,458 H \$1,614 I \$1,859 J \$2,152 L1 \$1,565 L2 \$1,741								
	Dimensions	D	W	H																		
Overall	19	22	17																			
CB7504S · Matte Nickel metal leg																						
Single Seat Bench 	CB7591W · wood leg	<table border="1"> <thead> <tr> <th>Dimensions</th> <th>D</th> <th>W</th> <th>H</th> </tr> </thead> <tbody> <tr> <td>Overall</td> <td>25 ½</td> <td>20 ½</td> <td>16</td> </tr> </tbody> </table>	Dimensions	D	W	H	Overall	25 ½	20 ½	16				COM \$1,091 A \$1,109 B \$1,144 COL/C \$1,205 D \$1,284 E \$1,361 F \$1,444 G \$1,561 H \$1,686 I \$1,882 J \$2,116 L1 \$1,647 L2 \$1,788								
	Dimensions	D	W	H																		
Overall	25 ½	20 ½	16																			
CB7591S · Matte Nickel metal leg																						

LOUNGE

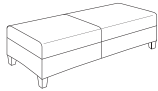
Description	Model	Specifications			List Price Per Grade		
Two Seat Bench 	CB7592W · wood leg	Dimensions			COM	\$1,483	
			D	W		H	A
		Overall	25 ½	40 ½	16	B	\$1,556
		Upholstery		Shipping		COL/C	\$1,640
		COM Ydg	2 ¾	Ctn Wt	76	D	\$1,747
		COL Sq Ft	55	Cu Ft	46	E	\$1,854
						F	\$1,967
						G	\$2,129
						H	\$2,301
						I	\$2,570
						J	\$2,892
						L1	\$2,247
						L2	\$2,441

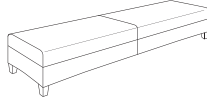
Description	Model	Specifications			List Price Per Grade		
Three Seat Bench 	CB7593W · wood leg	Dimensions			COM	\$1,805	
			D	W		H	A
		Overall	25 ½	60 ½	16	B	\$1,930
		Upholstery		Shipping		COL/C	\$2,074
		COM Ydg	4 ¾	Ctn Wt	116	D	\$2,260
		COL Sq Ft	95	Cu Ft	62	E	\$2,446
						F	\$2,641
						G	\$2,921
						H	\$3,218
						I	\$3,682
						J	\$4,238
						L1	\$3,124
						L2	\$3,458

To Order, Specify:

- 1 Model Number
- 2 Wood Species - Maple (M)
- 3 Wood Finish
- 4 Fabric Selection - vendor, pattern and color
- 5 Optional Rubber Cushion Nylon Glides - no upcharge
WOOD LEG MODELS ONLY

3 Wood Finish Options:▲

ALE Ale	FLX Flax
AUB Auburn	CGR Graphite Coordinate
AUT Autumn	CHL High Line Coordinate
BRL Barley	CKC Khaki Coordinate
CBE Blonde Echo Coordinate	LGC Legacy
BBN Bourbon	MCH Mocha
CBZ Brazilwood Coordinate	NTO Night Owl
BRG Brighton	PRL Praline
BUT Butterscotch	SAF Saffron
CIN Cinnamon	SIE Sienna
CLA Classic	CST Studio Teak Coordinate
CCF Coffee Coordinate	TOF Toffee
CCR Cremello Coordinate	TRF Truffle
EAR Earthy	VEN Venetian
ESP Espresso	CWH Walnut Heights Coordinate

Specifications

- Wood species - Maple.
- 7/8" thick furniture-grade plywood construction.
- Seat has 6" polyurethane foam with Dacron® wrap and synthetic sheet webbing with cross strap reinforcement.
- Back has 4 ½" polyurethane foam with synthetic sheet webbing suspension.
- Wood leg comes standard with rubber cushion metal glides (wood leg models only). Metal leg comes with stainless steel nylon glides.▲

When ordering Quickship products, place a "Q" in front of model number.
Example: QGT4901D



- 4 See a selection of graded in fabric manufacturers and patterns on pages 12-20. Contact Customer Service for additional fabric options.

Encore Lounge Order Check List:



Specify:

- 1. Model Number
- 2. Wood Species - Maple (M)
- 3. Wood Finish
- 4. Fabric Selection - vendor, pattern and color
- 5. Leg Style - disk or column
- 6. Leg/Trim Color - Black Sandtex (BSX) or Stardust Silver (STS)
- 7. Optional Easy Mobility Package - add \$115 list per chair; available on any single seat, non-wedge lounge
- 8. Optional Coordinating Wood Grain Laminate Surfaces - no upcharge

Example:

EN9201UW | M | AUB | MOMENTUM | VOX | MYSTIC | COLUMN | BLACK SANDTEX
 (model #) | (wood species) | (finish) | (fabric vendor) | (pattern name) | (pattern color) | (leg style) | (leg color)

1. Model Number

2. Wood Species - Maple (M)

3. Wood Finish Options:

ALE Ale*	FLX Flax
AUB Auburn*	LGC Legacy*
AUT Autumn*	MCH Mocha*
BRL Barley*	NTO Night Owl*
BBN Bourbon*	PRL Praline*
BRG Brighton*	SAF Saffron*
BUT Butterscotch	SIE Sienna*
CIN Cinnamon*	TOF Toffee*
CLA Classic*	TRF Truffle*
EAR Earthy	VEN Venetian*
ESP Espresso	

4. Fabric Selection - Please supply the following:

- Fabric vendor
- Pattern name
- Pattern color

When specifying contrasting upholstery, indicate clearly which upholstery is to be applied to the seat, back and arms. Use higher grade pricing.

- Indicate direction of fabric - Railroaded or Up the Roll
- Please provide illustration, if available

All COM orders must include the following:

- Vendor's name, pattern name and color
- Sample of the fabric attached to order
- Model numbers of items for fabric application
- Special application instructions (e.g., all stripes will be applied front to back unless specified otherwise)
- Customer and purchase order number

Ship prepaid COM material to:
 JSI
 Attn: COM Dept
 932 Mill Street
 Jasper, IN 47546

Application of fabric:
 Railroaded Up the Roll

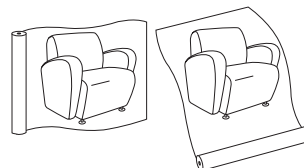

All COM orders will ship at standard lead time from receipt of COM except for orders requiring special custom matched finishes.

5. Leg Style Options:

Lounge Leg Style

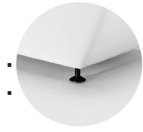

Lounge Disk Leg
adjustable height glide
nylon glide

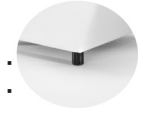

Lounge Column Leg
fixed height
nylon glide

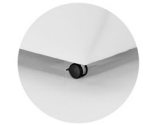

Lounge Caster

Table Leg Style



Table Disk Leg
adjustable height glide
nylon glide



Lounge Column Leg
fixed height
nylon glide

6. Leg/Trim Color - Black Sandtex (BSX) or Stardust Silver (STS);
all metal/trim color will match

7. Easy Mobility Package Option - add \$115 list per chair



- available on any single seat, non-wedge lounge
- front casters, back legs for easy mobility
- handle attached on back

8. Optional Coordinating Wood Grain Laminate Available on Wood Cap Arms, Tablet Arm and Table Tops - no upcharge.
Finishes with an asterisk (*) have a coordinating laminate available.

Description	① Model	Specifications			List Price Per Grade	
		Dimensions	D	W		H
Single Seat 	EN9201U · optional easy mobility package - add \$115 list per chair · optional tablet available on right or left arm (as seated in unit); specify when ordering and add \$313 list	Overall	29	35 ½	32	COM \$1,804
		Seat	20 ½	23 ½	18	A \$1,857
		Arm			26	B \$1,962
		Upholstery		Shipping		COL/C \$2,144
		COM Ydg	6	Ctn Wt	80	D \$2,379
		COL Sq Ft	120	Cu Ft	21	E \$2,613
						F \$2,861
						G \$3,212
						H \$3,587
						I \$4,174
						J \$4,878
						L1 \$3,471
						L2 \$3,893

Description	① Model	Specifications			List Price Per Grade	
		Dimensions	D	W		H
Single Seat with Folding Tablet Arm 	EN9251 · tablet arm: 19 ¼" x 10 ¾" · ¾" thick tablet features beveled edge · tablet height: 27" · rotating tablet with tilt and stow mechanism · clearance for tablet operations is 10" · includes easy mobility package · tablet available on right or left arm (as seated in unit); specify when ordering	Overall	29	36 ½	32	COM \$2,117
		Seat	20 ½	23 ½	18	A \$2,172
		Arm			26	B \$2,281
		Upholstery		Shipping		COL/C \$2,471
		COM Ydg	6 ¼	Ctn Wt	85	D \$2,716
		COL Sq Ft	125	Cu Ft	21	E \$2,959
						F \$3,218
						G \$3,584
						H \$3,975
						I \$4,586
						J \$5,319
						L1 \$3,853
						L2 \$4,292

tablet on right arm





tablet arm stowed





easy mobility package

LOUNGE

Description	① Model	Specifications			List Price Per Grade	
		Dimensions	D	W		H
Single Seat with Wood Cap Arm 	EN9201UW · metal spacers will match leg color · optional easy mobility package - add \$115 list per chair	Overall	30	36 ½	32	COM \$1,930
		Seat	20 ½	23 ½	18	A \$1,983
		Arm			24 ½	B \$2,088
		Upholstery		Shipping		COL/C \$2,270
		COM Ydg	6	Ctn Wt	80	D \$2,505
		COL Sq Ft	120	Cu Ft	21	E \$2,739
						F \$2,987
						G \$3,338
						H \$3,713
						I \$4,300
						J \$5,004
						L1 \$3,597
						L2 \$4,019

Description	1 Model	Specifications			List Price Per Grade	
Single Seat with Open Wood Cap Arm 	EN9201W • metal arm support will match leg color • optional easy mobility package - add \$115 list per chair	Dimensions			COM \$1,437 A \$1,463 B \$1,516 COL/C \$1,607 D \$1,725 E \$1,841 F \$1,965 G \$2,141 H \$2,328 I \$2,622 J \$2,974 L1 \$2,271 L2 \$2,482	
		Overall	D	W		H
		30	36 1/2	32		
		Seat	20 1/2	23 1/2		18
		Arm				24 1/2
		Upholstery		Shipping		
		COM Ydg	3	Ctn Wt		64
		COL Sq Ft	60	Cu Ft		21

Description	1 Model	Specifications			List Price Per Grade	
Single Seat  EN9201T-R right  EN9201T-L left	EN9201T-R EN9201T-L • 360° swivel tablet arm • optional tilt-out power available; specify right or left (as seated in unit); see page 297 for more details • tablet features flat edge • metal tablet arm will match leg color • optional easy mobility package - add \$115 list per chair	Dimensions			COM \$1,146 A \$1,172 B \$1,225 COL/C \$1,316 D \$1,434 E \$1,550 F \$1,674 G \$1,851 H \$2,037 I \$2,331 J \$2,683 L1 \$1,980 L2 \$2,191	
		Overall	D	W		H
		29	30 1/2	32		
		Seat	20 1/2	23 1/2		18
		Arm				24 1/2
		Upholstery		Shipping		
		COM Ydg	3	Ctn Wt		55
		COL Sq Ft	60	Cu Ft		18

To Order, Specify:

- 1 Model Number
- 2 Wood Species - Maple (M)
- 3 Wood Finish
- 4 Fabric Selection - vendor, pattern and color
- 5 Leg Style and Color
- 6 Metal Color - Black Sandtex (BSX) or Stardust Silver (STS)
- 7 Optional Easy Mobility Package - add \$115 list per chair; available on any single seat, non-wedge lounge. Optional Coordinating Wood Grain Laminate Available on Wood Cap Arms and Tablet Arm - no upcharge. Finishes with an asterisk have a coordinating laminate available.

3 Wood Finish Options:

ALE Ale*	FLX Flax
AUB Auburn*	LGC Legacy*
AUT Autumn*	MCH Mocha*
BRL Barley*	NTO Night Owl*
BBN Bourbon*	PRL Praline*
BRG Brighton*	SAF Saffron*
BUT Butterscotch	SIE Sienna*
CIN Cinnamon*	TOF Toffee*
CLA Classic*	TRF Truffle*
EAR Earthy	VEN Venetian*
ESP Espresso	

- 4 See a selection of graded in fabric manufacturers and patterns on pages 12-20. Contact Customer Service for additional fabric options.

Specifications

- Wood species - Maple.
- Seat has 8 1/2" high density polyurethane foam.
- Back has 7 1/2" high density polyurethane foam.
- Upholstered arms have 4 1/2" high density polyurethane foam.
- Wood caps and tablet are 3/4" thick
- Plywood construction with spiral grooved solid wood dowels, glue and screws.
- Some assembly required.
- Standard with nylon glides.

When ordering Quickship products, place a "Q" in front of model number.
 Example: QGT4901D

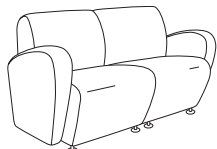
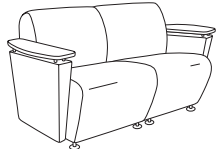
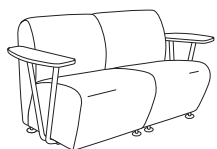
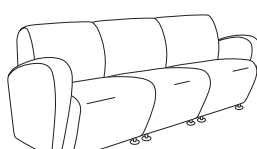

Description	① Model	Specifications	List Price Per Grade																																										
Two Seat 	EN9202U · optional tablet available on right or left arm (as seated in unit); specify when ordering and add \$313 list	<table border="1"> <thead> <tr> <th>Dimensions</th> <th>D</th> <th>W</th> <th>H</th> </tr> </thead> <tbody> <tr> <td>Overall</td> <td>29</td> <td>59 ¼</td> <td>32</td> </tr> <tr> <td>Seat</td> <td>20 ½</td> <td>47 ¼</td> <td>18</td> </tr> <tr> <td>Arm</td> <td></td> <td></td> <td>26</td> </tr> </tbody> </table>	Dimensions	D	W	H	Overall	29	59 ¼	32	Seat	20 ½	47 ¼	18	Arm			26	<table border="1"> <tbody> <tr><td>COM</td><td>\$2,805</td></tr> <tr><td>A</td><td>\$2,884</td></tr> <tr><td>B</td><td>\$3,040</td></tr> <tr><td>COL/C</td><td>\$3,314</td></tr> <tr><td>D</td><td>\$3,666</td></tr> <tr><td>E</td><td>\$4,018</td></tr> <tr><td>F</td><td>\$4,389</td></tr> <tr><td>G</td><td>\$4,917</td></tr> <tr><td>H</td><td>\$5,479</td></tr> <tr><td>I</td><td>\$6,359</td></tr> <tr><td>J</td><td>\$7,415</td></tr> <tr><td>L1</td><td>\$5,304</td></tr> <tr><td>L2</td><td>\$5,937</td></tr> </tbody> </table>	COM	\$2,805	A	\$2,884	B	\$3,040	COL/C	\$3,314	D	\$3,666	E	\$4,018	F	\$4,389	G	\$4,917	H	\$5,479	I	\$6,359	J	\$7,415	L1	\$5,304	L2	\$5,937
		Dimensions	D	W	H																																								
Overall	29	59 ¼	32																																										
Seat	20 ½	47 ¼	18																																										
Arm			26																																										
COM	\$2,805																																												
A	\$2,884																																												
B	\$3,040																																												
COL/C	\$3,314																																												
D	\$3,666																																												
E	\$4,018																																												
F	\$4,389																																												
G	\$4,917																																												
H	\$5,479																																												
I	\$6,359																																												
J	\$7,415																																												
L1	\$5,304																																												
L2	\$5,937																																												
		<table border="1"> <thead> <tr> <th>Upholstery</th> <th colspan="2">Shipping</th> </tr> </thead> <tbody> <tr> <td>COM Ydg</td> <td>9</td> <td>Ctn Wt 130</td> </tr> <tr> <td>COL Sq Ft</td> <td>180</td> <td>Cu Ft 35</td> </tr> </tbody> </table>	Upholstery	Shipping		COM Ydg	9	Ctn Wt 130	COL Sq Ft	180	Cu Ft 35																																		
Upholstery	Shipping																																												
COM Ydg	9	Ctn Wt 130																																											
COL Sq Ft	180	Cu Ft 35																																											
Two Seat with Wood Cap Arm 	EN9202UW · metal spacers will match leg color	<table border="1"> <thead> <tr> <th>Dimensions</th> <th>D</th> <th>W</th> <th>H</th> </tr> </thead> <tbody> <tr> <td>Overall</td> <td>30</td> <td>60 ¼</td> <td>32</td> </tr> <tr> <td>Seat</td> <td>20 ½</td> <td>47 ¼</td> <td>18</td> </tr> <tr> <td>Arm</td> <td></td> <td></td> <td>24 ½</td> </tr> </tbody> </table>	Dimensions	D	W	H	Overall	30	60 ¼	32	Seat	20 ½	47 ¼	18	Arm			24 ½	<table border="1"> <tbody> <tr><td>COM</td><td>\$2,932</td></tr> <tr><td>A</td><td>\$3,011</td></tr> <tr><td>B</td><td>\$3,167</td></tr> <tr><td>COL/C</td><td>\$3,441</td></tr> <tr><td>D</td><td>\$3,793</td></tr> <tr><td>E</td><td>\$4,145</td></tr> <tr><td>F</td><td>\$4,517</td></tr> <tr><td>G</td><td>\$5,044</td></tr> <tr><td>H</td><td>\$5,606</td></tr> <tr><td>I</td><td>\$6,486</td></tr> <tr><td>J</td><td>\$7,542</td></tr> <tr><td>L1</td><td>\$5,431</td></tr> <tr><td>L2</td><td>\$6,064</td></tr> </tbody> </table>	COM	\$2,932	A	\$3,011	B	\$3,167	COL/C	\$3,441	D	\$3,793	E	\$4,145	F	\$4,517	G	\$5,044	H	\$5,606	I	\$6,486	J	\$7,542	L1	\$5,431	L2	\$6,064
		Dimensions	D	W	H																																								
Overall	30	60 ¼	32																																										
Seat	20 ½	47 ¼	18																																										
Arm			24 ½																																										
COM	\$2,932																																												
A	\$3,011																																												
B	\$3,167																																												
COL/C	\$3,441																																												
D	\$3,793																																												
E	\$4,145																																												
F	\$4,517																																												
G	\$5,044																																												
H	\$5,606																																												
I	\$6,486																																												
J	\$7,542																																												
L1	\$5,431																																												
L2	\$6,064																																												
		<table border="1"> <thead> <tr> <th>Upholstery</th> <th colspan="2">Shipping</th> </tr> </thead> <tbody> <tr> <td>COM Ydg</td> <td>9</td> <td>Ctn Wt 130</td> </tr> <tr> <td>COL Sq Ft</td> <td>180</td> <td>Cu Ft 35</td> </tr> </tbody> </table>	Upholstery	Shipping		COM Ydg	9	Ctn Wt 130	COL Sq Ft	180	Cu Ft 35																																		
Upholstery	Shipping																																												
COM Ydg	9	Ctn Wt 130																																											
COL Sq Ft	180	Cu Ft 35																																											
Two Seat with Open Wood Cap Arm 	EN9202W · metal arm support will match leg color	<table border="1"> <thead> <tr> <th>Dimensions</th> <th>D</th> <th>W</th> <th>H</th> </tr> </thead> <tbody> <tr> <td>Overall</td> <td>30</td> <td>60 ¼</td> <td>32</td> </tr> <tr> <td>Seat</td> <td>20 ½</td> <td>47 ¼</td> <td>18</td> </tr> <tr> <td>Arm</td> <td></td> <td></td> <td>24 ½</td> </tr> </tbody> </table>	Dimensions	D	W	H	Overall	30	60 ¼	32	Seat	20 ½	47 ¼	18	Arm			24 ½	<table border="1"> <tbody> <tr><td>COM</td><td>\$2,443</td></tr> <tr><td>A</td><td>\$2,495</td></tr> <tr><td>B</td><td>\$2,600</td></tr> <tr><td>COL/C</td><td>\$2,782</td></tr> <tr><td>D</td><td>\$3,017</td></tr> <tr><td>E</td><td>\$3,251</td></tr> <tr><td>F</td><td>\$3,499</td></tr> <tr><td>G</td><td>\$3,851</td></tr> <tr><td>H</td><td>\$4,226</td></tr> <tr><td>I</td><td>\$4,813</td></tr> <tr><td>J</td><td>\$5,516</td></tr> <tr><td>L1</td><td>\$4,109</td></tr> <tr><td>L2</td><td>\$4,531</td></tr> </tbody> </table>	COM	\$2,443	A	\$2,495	B	\$2,600	COL/C	\$2,782	D	\$3,017	E	\$3,251	F	\$3,499	G	\$3,851	H	\$4,226	I	\$4,813	J	\$5,516	L1	\$4,109	L2	\$4,531
		Dimensions	D	W	H																																								
Overall	30	60 ¼	32																																										
Seat	20 ½	47 ¼	18																																										
Arm			24 ½																																										
COM	\$2,443																																												
A	\$2,495																																												
B	\$2,600																																												
COL/C	\$2,782																																												
D	\$3,017																																												
E	\$3,251																																												
F	\$3,499																																												
G	\$3,851																																												
H	\$4,226																																												
I	\$4,813																																												
J	\$5,516																																												
L1	\$4,109																																												
L2	\$4,531																																												
		<table border="1"> <thead> <tr> <th>Upholstery</th> <th colspan="2">Shipping</th> </tr> </thead> <tbody> <tr> <td>COM Ydg</td> <td>6</td> <td>Ctn Wt 114</td> </tr> <tr> <td>COL Sq Ft</td> <td>120</td> <td>Cu Ft 35</td> </tr> </tbody> </table>	Upholstery	Shipping		COM Ydg	6	Ctn Wt 114	COL Sq Ft	120	Cu Ft 35																																		
Upholstery	Shipping																																												
COM Ydg	6	Ctn Wt 114																																											
COL Sq Ft	120	Cu Ft 35																																											
Three Seat 	EN9203U · optional tablet available on right or left arm (as seated in unit); specify when ordering and add \$313 list	<table border="1"> <thead> <tr> <th>Dimensions</th> <th>D</th> <th>W</th> <th>H</th> </tr> </thead> <tbody> <tr> <td>Overall</td> <td>29</td> <td>83</td> <td>32</td> </tr> <tr> <td>Seat</td> <td>20 ½</td> <td>70 ¾</td> <td>18</td> </tr> <tr> <td>Arm</td> <td></td> <td></td> <td>26</td> </tr> </tbody> </table>	Dimensions	D	W	H	Overall	29	83	32	Seat	20 ½	70 ¾	18	Arm			26	<table border="1"> <tbody> <tr><td>COM</td><td>\$3,811</td></tr> <tr><td>A</td><td>\$3,916</td></tr> <tr><td>B</td><td>\$4,125</td></tr> <tr><td>COL/C</td><td>\$4,489</td></tr> <tr><td>D</td><td>\$4,959</td></tr> <tr><td>E</td><td>\$5,428</td></tr> <tr><td>F</td><td>\$5,922</td></tr> <tr><td>G</td><td>\$6,627</td></tr> <tr><td>H</td><td>\$7,377</td></tr> <tr><td>I</td><td>\$8,550</td></tr> <tr><td>J</td><td>\$9,958</td></tr> <tr><td>L1</td><td>\$7,143</td></tr> <tr><td>L2</td><td>\$7,987</td></tr> </tbody> </table>	COM	\$3,811	A	\$3,916	B	\$4,125	COL/C	\$4,489	D	\$4,959	E	\$5,428	F	\$5,922	G	\$6,627	H	\$7,377	I	\$8,550	J	\$9,958	L1	\$7,143	L2	\$7,987
		Dimensions	D	W	H																																								
Overall	29	83	32																																										
Seat	20 ½	70 ¾	18																																										
Arm			26																																										
COM	\$3,811																																												
A	\$3,916																																												
B	\$4,125																																												
COL/C	\$4,489																																												
D	\$4,959																																												
E	\$5,428																																												
F	\$5,922																																												
G	\$6,627																																												
H	\$7,377																																												
I	\$8,550																																												
J	\$9,958																																												
L1	\$7,143																																												
L2	\$7,987																																												
		<table border="1"> <thead> <tr> <th>Upholstery</th> <th colspan="2">Shipping</th> </tr> </thead> <tbody> <tr> <td>COM Ydg</td> <td>12</td> <td>Ctn Wt 180</td> </tr> <tr> <td>COL Sq Ft</td> <td>240</td> <td>Cu Ft 49</td> </tr> </tbody> </table>	Upholstery	Shipping		COM Ydg	12	Ctn Wt 180	COL Sq Ft	240	Cu Ft 49																																		
Upholstery	Shipping																																												
COM Ydg	12	Ctn Wt 180																																											
COL Sq Ft	240	Cu Ft 49																																											

LOUNGE

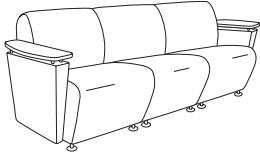
Description	① Model	Specifications			List Price Per Grade		
		Dimensions	D	W	H	COM	
Three Seat with Wood Cap Arm 	EN9203UW · metal spacers will match leg color	Overall	30	84	32	COM	\$3,937
		Seat	20½	70¾	18	A	\$4,042
		Arm			24½	B	\$4,251
		Upholstery		Shipping		COL/C	\$4,615
		COM Ydg	12	Ctn Wt	180	D	\$5,085
		COL Sq Ft	240	Cu Ft	49	E	\$5,554
						F	\$6,048
						G	\$6,753
						H	\$7,503
						I	\$8,676
						J	\$10,084
						L1	\$7,269
						L2	\$8,113

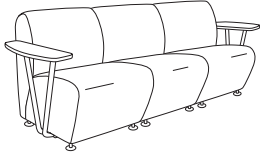
Description	① Model	Specifications			List Price Per Grade		
		Dimensions	D	W	H	COM	
Three Seat with Open Wood Cap Arm 	EN9203W · metal arm support will match leg color	Overall	30	84	32	COM	\$3,443
		Seat	20½	70¾	18	A	\$3,522
		Arm			24½	B	\$3,679
		Upholstery		Shipping		COL/C	\$3,953
		COM Ydg	9	Ctn Wt	164	D	\$4,304
		COL Sq Ft	180	Cu Ft	49	E	\$4,656
						F	\$5,028
						G	\$5,555
						H	\$6,118
						I	\$6,998
						J	\$8,053
						L1	\$5,942
						L2	\$6,576

To Order, Specify:

- ① Model Number
- ② Wood Species - Maple (M)
- ③ Wood Finish
- ④ Fabric Selection - vendor, pattern and color
- ⑤ Leg Style and Color
- ⑥ Metal Color - Black Sandtex (BSX) or Stardust Silver (STS)
- ⑦ Optional Coordinating Wood Grain Laminate Available on Wood Cap Arms and Tablet Arm - no upcharge.
Finishes with an asterisk have a coordinating laminate available.

③ Wood Finish Options:

ALE Ale*	FLX Flax
AUB Auburn*	LGC Legacy*
AUT Autumn*	MCH Mocha*
BRL Barley*	NTO Night Owl*
BBN Bourbon*	PRL Praline*
BRG Brighton*	SAF Saffron*
BUT Butterscotch	SIE Sienna*
CIN Cinnamon*	TOF Toffee*
CLA Classic*	TRF Truffle*
EAR Earthy	VEN Venetian*
ESP Espresso	

- ④ See a selection of graded in fabric manufacturers and patterns on pages 12-20. Contact Customer Service for additional fabric options.

Specifications

- Wood species - Maple.
- Seat has 8½" high density polyurethane foam.
- Back has 7½" high density polyurethane foam.
- Upholstered arms have 4½" high density polyurethane foam.
- Wood caps and tablet are ¾" thick
- Plywood construction with spiral grooved solid wood dowels, glue and screws.
- Some assembly required.
- Standard with nylon glides.

When ordering Quickship products, place a "Q" in front of model number.
Example: QGT4901D



Description	D	W	H	CTN WT	CU FT	Model	List Price
Oval Magazine Table	21 1/2	42 1/2	17	25	3	EN2142	\$1,017

NOW!

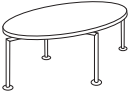

Round Magazine Table	36 1/2	36 1/2	17	28	4	EN36R	\$944
	30 1/2	30 1/2	17	25	3	EN30R	\$919

NOW!



Rectangular Magazine Table	24 1/2	48 1/2	17	30	4	EN2448	\$889
----------------------------	--------	--------	----	----	---	--------	-------

NOW!



Square End Table	30 3/4	30 3/4	22 1/4	25	3	EN3030-22	\$861
	24 3/4	24 3/4	22 1/4	20	3	EN2424-22	\$748

NOW!

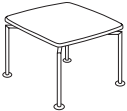

Square Magazine Table	30 3/4	30 3/4	17	25	3	EN3030-17	\$839
	24 3/4	24 3/4	17	20	3	EN2424-17	\$729

NOW!

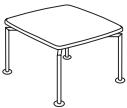

LOUNGE

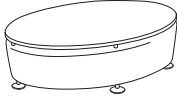
Description	1 Model	Specifications				List Price Per Grade	
		Dimensions	D	W	H	COM	
Oval Magazine Table NOW! 	EN2142B · upholstered base · metal spacers will match leg color	Overall	21 1/2	42 1/2	17	COM	\$1,213
		Upholstery		Shipping		A	\$1,229
		COM Ydg	1 3/4	Ctn Wt	56	B	\$1,259
		COL Sq Ft	35	Cu Ft	10	COL/C	\$1,313
						D	\$1,381
						E	\$1,449
						F	\$1,522
						G	\$1,624
						H	\$1,734
						I	\$1,905
						J	\$2,110
						L1	\$1,699
						L2	\$1,822

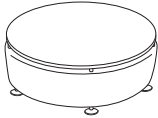
Description	1 Model	Specifications				List Price Per Grade	
		Dimensions	D	W	H	COM	
Round Magazine Table NOW! 	EN36RB · upholstered base · metal spacers will match leg color	Overall	36 1/2	36 1/2	17	COM	\$1,149
		Upholstery		Shipping		A	\$1,175
		COM Ydg	3	Ctn Wt	75	B	\$1,228
		COL Sq Ft	60	Cu Ft	14	COL/C	\$1,319
						D	\$1,437
						E	\$1,553
						F	\$1,677
						G	\$1,854
						H	\$2,041
						I	\$2,335
						J	\$2,686
						L1	\$1,983
						L2	\$2,194

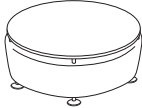
Description	1 Model	Specifications				List Price Per Grade	
		Dimensions	D	W	H	COM	
Round Magazine Table NOW! 	EN30RB · upholstered base · metal spacers will match leg color	Overall	30 1/2	30 1/2	17	COM	\$1,124
		Upholstery		Shipping		A	\$1,142
		COM Ydg	2	Ctn Wt	58	B	\$1,176
		COL Sq Ft	40	Cu Ft	11	COL/C	\$1,237
						D	\$1,316
						E	\$1,394
						F	\$1,477
						G	\$1,593
						H	\$1,718
						I	\$1,915
						J	\$2,149
						L1	\$1,679
						L2	\$1,820

To Order, Specify:

- 1 Model Number
- 2 Wood Species - Maple (M)
- 3 Wood Finish
- 4 Fabric Selection - vendor, pattern and color
- 5 Leg Style and Color
- 6 Metal Color - Black Sandtex (BSX) or Stardust Silver (STS)
- 7 Optional Coordinating Wood Grain Laminate Available on Table top - no upcharge. Finishes with an asterisk have a coordinating laminate available.

3 Wood Finish Options:

- | | |
|------------------|----------------|
| ALE Ale* | FLX Flax |
| AUB Auburn* | LGC Legacy* |
| AUT Autumn* | MCH Mocha* |
| BRL Barley* | NTO Night Owl* |
| BBN Bourbon* | PRL Praline* |
| BRG Brighton* | SAF Saffron* |
| BUT Butterscotch | SIE Sienna* |
| CIN Cinnamon* | TOF Toffee* |
| CLA Classic* | TRF Truffle* |
| EAR Earthy | VEN Venetian* |
| ESP Espresso | |

- 4 See a selection of graded in fabric manufacturers and patterns on pages 12-20. Contact Customer Service for additional fabric options.

Specifications

- Wood species - Maple.
- Table tops are 3/4" thick.
- Upholstered bases have 4 1/2" high density polyurethane foam.
- Plywood construction with spiral grooved solid wood dowels, glue and screws.
- Tables ship KD; some assembly required.
- Standard with nylon glides.

When ordering Quickship products, place a "Q" in front of model number.
Example: QGT4901D

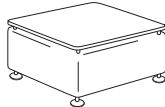
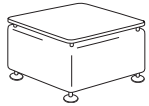
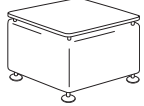

Description	① Model	Specifications			List Price Per Grade	
		Dimensions	D	W		H
Square Magazine Table 	EN3030-17B · upholstered base · metal spacers will match leg color	Overall	30 ¾	30 ¾	17	COM \$1,047
		Upholstery		Shipping		A \$1,074
		COM Ydg	3	Ctn Wt	78	B \$1,126
		COL Sq Ft	60	Cu Ft	11	COL/C \$1,217
						D \$1,335
Square Magazine Table 	EN2424-17B · upholstered base · metal spacers will match leg color	Overall	24 ¾	24 ¾	17	E \$1,452
		Upholstery		Shipping		F \$1,575
		COM Ydg	2	Ctn Wt	58	G \$1,752
		COL Sq Ft	40	Cu Ft	8	H \$1,939
						I \$2,233
Square End Table 	EN2424-22B · upholstered base · metal spacers will match leg color	Overall	24 ¾	24 ¾	22	J \$2,585
		Upholstery		Shipping		L1 \$1,881
		COM Ydg	2 ½	Ctn Wt	65	L2 \$2,092
		COL Sq Ft	43	Cu Ft	10	

LOUNGE

To Order, Specify:

- ① Model Number
- ② Wood Species - Maple (M)
- ③ Wood Finish
- ④ Fabric Selection - vendor, pattern and color
- ⑤ Leg Style and Color
- ⑥ Metal Color - Black Sandtex (BSX) or Stardust Silver (STS)
- ⑦ Optional Coordinating Wood Grain Laminate Available on Table top - no upcharge. Finishes with an asterisk have a coordinating laminate available.

③ Wood Finish Options:

- | | |
|------------------|----------------|
| ALE Ale* | FLX Flax |
| AUB Auburn* | LGC Legacy* |
| AUT Autumn* | MCH Mocha* |
| BRL Barley* | NTO Night Owl* |
| BBN Bourbon* | PRL Praline* |
| BRG Brighton* | SAF Saffron* |
| BUT Bitterscotch | SIE Sienna* |
| CIN Cinnamon* | TOF Toffee* |
| CLA Classic* | TRF Truffle* |
| EAR Earthy | VEN Venetian* |
| ESP Espresso | |

- ④ See a selection of graded in fabric manufacturers and patterns on pages 12-20. Contact Customer Service for additional fabric options.



Specifications

- Wood species - Maple veneer.
- Table tops are ¾" thick.
- Upholstered bases have 4 ½" high density polyurethane foam.
- Plywood construction with spiral grooved solid wood dowels, glue and screws.
- Tables ship KD; some assembly required.
- Standard with nylon glides.

When ordering Quickship products, place a "Q" in front of model number.
 Example: QGT4901D

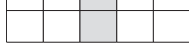

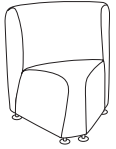
Description	Model	Specifications			List Price Per Grade		
		Dimensions	D	W	H	COM	
Armless Lounge   Front	EN9210 <ul style="list-style-type: none"> optional tilt-out power available; specify right or left (as seated in unit); see page 297 for more details optional easy mobility package - add \$115 list optional rotating tablet arm - see page 294; specify right (EN9230T-R) or left (EN9230T-L) 	Overall	29	23 1/2	32	COM	\$1,008
		Seat	20 1/2	23 1/2	18	COL/C	\$1,179
		Upholstery		Shipping			
		COM Ydg	3	Ctn Wt	50	D	\$1,296
		COL Sq Ft	60	Cu Ft	14	E	\$1,413
						F	\$1,537
						G	\$1,713
						H	\$1,900
						I	\$2,194
						J	\$2,546
						L1	\$1,842
						L2	\$2,053

Description	Model	Specifications			List Price Per Grade		
		Dimensions	D	W	H	COM	
45° Armless Lounge   Front	EN9211 <ul style="list-style-type: none"> 45° inside angle seat two units joined - 90° unit casters not recommended tilt-out power not available 	Overall	29	26 1/2	32	COM	\$963
		Seat	20 1/2	23 1/2	18	COL/C	\$1,147
		Upholstery		Shipping			
		COM Ydg	3 1/4	Ctn Wt	44	D	\$1,274
		COL Sq Ft	65	Cu Ft	14	E	\$1,401
						F	\$1,536
						G	\$1,727
						H	\$1,929
						I	\$2,247
						J	\$2,629
						L1	\$1,866
						L2	\$2,094

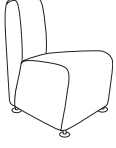
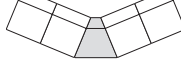
Description	Model	Specifications			List Price Per Grade		
		Dimensions	D	W	H	COM	
45° Armless Lounge   Front	EN9212 <ul style="list-style-type: none"> 45° outside angle seat two units joined - 90° unit casters not recommended tilt-out power not available 	Overall	29	26 1/2	32	COM	\$963
		Seat	20 1/2	23 1/2	18	COL/C	\$1,147
		Upholstery		Shipping			
		COM Ydg	3 1/4	Ctn Wt	44	D	\$1,274
		COL Sq Ft	65	Cu Ft	14	E	\$1,401
						F	\$1,536
						G	\$1,727
						H	\$1,929
						I	\$2,247
						J	\$2,629
						L1	\$1,866
						L2	\$2,094

To Order, Specify:

- Model Number
- Wood Species - Maple (M)
- Wood Finish
- Fabric Selection - vendor, pattern and color
- Leg Style and Color
- Metal Color - Black Sandtex (BSX) or Stardust Silver (STS)
- Optional Easy Mobility Package - add \$115 list per chair; available on any single seat, non-wedge lounge

Wood Finish Options:

- | | |
|------------------|---------------|
| ALE Ale | FLX Flax |
| AUB Auburn | LGC Legacy |
| AUT Autumn | MCH Mocha |
| BRL Barley | NTO Night Owl |
| BBN Bourbon | PRL Praline |
| BRG Brighton | SAF Saffron |
| BUT Butterscotch | SIE Sienna |
| CIN Cinnamon | TOF Toffee |
| CLA Classic | TRF Truffle |
| EAR Earthy | VEN Venetian |
| ESP Espresso | |

Specifications

- Wood species - Maple.
- Seat has 8 1/2" high density polyurethane foam.
- Back has 7 1/2" high density polyurethane foam.
- Plywood construction with spiral grooved solid wood dowels, glue and screws.
- Linking bracket included.
- Some assembly required.
- Standard with nylon glides.

See a selection of graded in fabric manufacturers and patterns on pages 12-20. Contact Customer Service for additional fabric options.

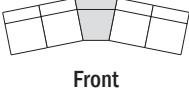
Description	① Model	Specifications	List Price Per Grade																								
22.5° Modular Armless Lounge   Front	EN9213 · 22.5° inside angle seat · casters not recommended · tilt-out power not available	<table border="1"> <thead> <tr> <th>Dimensions</th> <th>D</th> <th>W</th> <th>H</th> </tr> </thead> <tbody> <tr> <td>Overall</td> <td>29</td> <td>26½</td> <td>32</td> </tr> <tr> <td>Seat</td> <td>20½</td> <td>23½</td> <td>18</td> </tr> <tr> <th colspan="2">Upholstery</th> <th colspan="2">Shipping</th> </tr> <tr> <td>COM Ydg</td> <td>3¼</td> <td>Ctn Wt</td> <td>44</td> </tr> <tr> <td>COL Sq Ft</td> <td>65</td> <td>Cu Ft</td> <td>14</td> </tr> </tbody> </table>	Dimensions	D	W	H	Overall	29	26½	32	Seat	20½	23½	18	Upholstery		Shipping		COM Ydg	3¼	Ctn Wt	44	COL Sq Ft	65	Cu Ft	14	COM \$1,076 A \$1,105 B \$1,161 COL/C \$1,259 D \$1,386 E \$1,514 F \$1,648 G \$1,839 H \$2,042 I \$2,360 J \$2,741 L1 \$1,979 L2 \$2,207
		Dimensions	D	W	H																						
Overall	29	26½	32																								
Seat	20½	23½	18																								
Upholstery		Shipping																									
COM Ydg	3¼	Ctn Wt	44																								
COL Sq Ft	65	Cu Ft	14																								

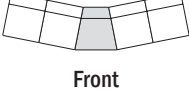
22.5° Modular Armless Lounge   Front	EN9214 · 22.5° outside angle seat · casters not recommended · tilt-out power not available	<table border="1"> <thead> <tr> <th>Dimensions</th> <th>D</th> <th>W</th> <th>H</th> </tr> </thead> <tbody> <tr> <td>Overall</td> <td>29</td> <td>26½</td> <td>32</td> </tr> <tr> <td>Seat</td> <td>20½</td> <td>23½</td> <td>18</td> </tr> <tr> <th colspan="2">Upholstery</th> <th colspan="2">Shipping</th> </tr> <tr> <td>COM Ydg</td> <td>3¼</td> <td>Ctn Wt</td> <td>44</td> </tr> <tr> <td>COL Sq Ft</td> <td>65</td> <td>Cu Ft</td> <td>14</td> </tr> </tbody> </table>	Dimensions	D	W	H	Overall	29	26½	32	Seat	20½	23½	18	Upholstery		Shipping		COM Ydg	3¼	Ctn Wt	44	COL Sq Ft	65	Cu Ft	14	COM \$1,076 A \$1,105 B \$1,161 COL/C \$1,259 D \$1,386 E \$1,514 F \$1,648 G \$1,839 H \$2,042 I \$2,360 J \$2,741 L1 \$1,979 L2 \$2,207
		Dimensions	D	W	H																						
Overall	29	26½	32																								
Seat	20½	23½	18																								
Upholstery		Shipping																									
COM Ydg	3¼	Ctn Wt	44																								
COL Sq Ft	65	Cu Ft	14																								

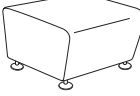
Bench 	EN9710 · optional tilt-out power available; specify right or left (as seated in unit); see page 297 for more details · tilt-out power can be installed on either side of the unit, cannot be installed in the front or back · to be used for straight connections only, cannot make a 90° turn · optional casters available, specify when ordering · optional rotating tablet arm - see page 294; specify right (EN9230T-R) or left (EN9230T-L)	<table border="1"> <thead> <tr> <th>Dimensions</th> <th>D</th> <th>W</th> <th>H</th> </tr> </thead> <tbody> <tr> <td>Overall</td> <td>25½</td> <td>23½</td> <td>17</td> </tr> <tr> <th colspan="2">Upholstery</th> <th colspan="2">Shipping</th> </tr> <tr> <td>COM Ydg</td> <td>2</td> <td>Ctn Wt</td> <td>43</td> </tr> <tr> <td>COL Sq Ft</td> <td>40</td> <td>Cu Ft</td> <td>8</td> </tr> </tbody> </table>	Dimensions	D	W	H	Overall	25½	23½	17	Upholstery		Shipping		COM Ydg	2	Ctn Wt	43	COL Sq Ft	40	Cu Ft	8	COM \$685 A \$703 B \$738 COL/C \$798 D \$877 E \$955 F \$1,038 G \$1,154 H \$1,279 I \$1,476 J \$1,710 L1 \$1,241 L2 \$1,381
		Dimensions	D	W	H																		
Overall	25½	23½	17																				
Upholstery		Shipping																					
COM Ydg	2	Ctn Wt	43																				
COL Sq Ft	40	Cu Ft	8																				

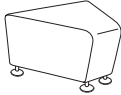
Description	1 Model	Specifications	List Price Per Grade																																				
45° Bench 	EN9711 · 45° angle single seat · two units joined - 90° unit · casters and tilt out power not available	<table border="1"> <thead> <tr> <th>Dimensions</th> <th>D</th> <th>W</th> <th>H</th> </tr> </thead> <tbody> <tr> <td>Overall</td> <td>25 1/2</td> <td>27</td> <td>17</td> </tr> </tbody> </table>	Dimensions	D	W	H	Overall	25 1/2	27	17	<table border="1"> <thead> <tr> <th>COM</th> <th>Price</th> </tr> </thead> <tbody> <tr><td>COM</td><td>\$658</td></tr> <tr><td>A</td><td>\$676</td></tr> <tr><td>B</td><td>\$710</td></tr> <tr><td>COL/C</td><td>\$771</td></tr> <tr><td>D</td><td>\$850</td></tr> <tr><td>E</td><td>\$928</td></tr> <tr><td>F</td><td>\$1,011</td></tr> <tr><td>G</td><td>\$1,127</td></tr> <tr><td>H</td><td>\$1,252</td></tr> <tr><td>I</td><td>\$1,448</td></tr> <tr><td>J</td><td>\$1,683</td></tr> <tr><td>L1</td><td>\$1,213</td></tr> <tr><td>L2</td><td>\$1,354</td></tr> </tbody> </table>	COM	Price	COM	\$658	A	\$676	B	\$710	COL/C	\$771	D	\$850	E	\$928	F	\$1,011	G	\$1,127	H	\$1,252	I	\$1,448	J	\$1,683	L1	\$1,213	L2	\$1,354
		Dimensions	D	W	H																																		
Overall	25 1/2	27	17																																				
COM	Price																																						
COM	\$658																																						
A	\$676																																						
B	\$710																																						
COL/C	\$771																																						
D	\$850																																						
E	\$928																																						
F	\$1,011																																						
G	\$1,127																																						
H	\$1,252																																						
I	\$1,448																																						
J	\$1,683																																						
L1	\$1,213																																						
L2	\$1,354																																						
		<table border="1"> <thead> <tr> <th>Upholstery</th> <th>Shipping</th> </tr> </thead> <tbody> <tr> <td>COM Ydg</td> <td>2 Ctn Wt 41</td> </tr> <tr> <td>COL Sq Ft</td> <td>40 Cu Ft 8</td> </tr> </tbody> </table>	Upholstery	Shipping	COM Ydg	2 Ctn Wt 41	COL Sq Ft	40 Cu Ft 8																															
Upholstery	Shipping																																						
COM Ydg	2 Ctn Wt 41																																						
COL Sq Ft	40 Cu Ft 8																																						

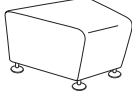
22.5° Bench 	EN9713 · 22.5° angle single seat · casters and tilt out power not available	<table border="1"> <thead> <tr> <th>Dimensions</th> <th>D</th> <th>W</th> <th>H</th> </tr> </thead> <tbody> <tr> <td>Overall</td> <td>25 1/2</td> <td>26 1/2</td> <td>17</td> </tr> </tbody> </table>	Dimensions	D	W	H	Overall	25 1/2	26 1/2	17	<table border="1"> <thead> <tr> <th>COM</th> <th>Price</th> </tr> </thead> <tbody> <tr><td>COM</td><td>\$735</td></tr> <tr><td>A</td><td>\$753</td></tr> <tr><td>B</td><td>\$788</td></tr> <tr><td>COL/C</td><td>\$849</td></tr> <tr><td>D</td><td>\$928</td></tr> <tr><td>E</td><td>\$1,005</td></tr> <tr><td>F</td><td>\$1,088</td></tr> <tr><td>G</td><td>\$1,205</td></tr> <tr><td>H</td><td>\$1,330</td></tr> <tr><td>I</td><td>\$1,526</td></tr> <tr><td>J</td><td>\$1,760</td></tr> <tr><td>L1</td><td>\$1,291</td></tr> <tr><td>L2</td><td>\$1,432</td></tr> </tbody> </table>	COM	Price	COM	\$735	A	\$753	B	\$788	COL/C	\$849	D	\$928	E	\$1,005	F	\$1,088	G	\$1,205	H	\$1,330	I	\$1,526	J	\$1,760	L1	\$1,291	L2	\$1,432
		Dimensions	D	W	H																																		
Overall	25 1/2	26 1/2	17																																				
COM	Price																																						
COM	\$735																																						
A	\$753																																						
B	\$788																																						
COL/C	\$849																																						
D	\$928																																						
E	\$1,005																																						
F	\$1,088																																						
G	\$1,205																																						
H	\$1,330																																						
I	\$1,526																																						
J	\$1,760																																						
L1	\$1,291																																						
L2	\$1,432																																						
		<table border="1"> <thead> <tr> <th>Upholstery</th> <th>Shipping</th> </tr> </thead> <tbody> <tr> <td>COM Ydg</td> <td>2 Ctn Wt 41</td> </tr> <tr> <td>COL Sq Ft</td> <td>40 Cu Ft 8</td> </tr> </tbody> </table>	Upholstery	Shipping	COM Ydg	2 Ctn Wt 41	COL Sq Ft	40 Cu Ft 8																															
Upholstery	Shipping																																						
COM Ydg	2 Ctn Wt 41																																						
COL Sq Ft	40 Cu Ft 8																																						

To Order, Specify:

- 1 Model Number
- 2 Wood Species - Maple (M)
- 3 Wood Finish
- 4 Fabric Selection - vendor, pattern and color
- 5 Leg Style and Color
- 6 Metal Color - Black Sandtex (BSX) or Stardust Silver (STS)



3 Wood Finish Options:

- | | |
|------------------|---------------|
| ALE Ale | FLX Flax |
| AUB Auburn | LGC Legacy |
| AUT Autumn | MCH Mocha |
| BRL Barley | NTO Night Owl |
| BBN Bourbon | PRL Praline |
| BRG Brighton | SAF Saffron |
| BUT Butterscotch | SIE Sienna |
| CIN Cinnamon | TOF Toffee |
| CLA Classic | TRF Truffle |
| EAR Earthy | VEN Venetian |
| ESP Espresso | |



Specifications

- Wood species - Maple.
- Seat has 8 1/2" high density polyurethane foam.
- Back has 7 1/2" high density polyurethane foam.
- Plywood construction with spiral grooved solid wood dowels, glue and screws.
- Linking bracket included.
- Some assembly required.
- Standard with nylon glides.

- 4 See a selection of graded in fabric manufacturers and patterns on pages 12-20. Contact Customer Service for additional fabric options.

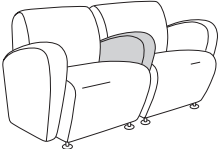
Description	① Model	Specifications				List Price Per Grade	
Modular End Arm (arm only)	EN9220U-R EN9220U-L <ul style="list-style-type: none"> · fully upholstered · for use on right or left end (as seated in unit) · optional tablet available on right or left arm (as seated in unit); specify when ordering and add \$313 list 	Dimensions		D	W	H	COM \$403
		Overall		23	6	25½	A \$417
 EN9220U-R right	 EN9220U-L left	Upholstery		Shipping		B \$446	COL/C \$495
		COM Ydg	1 5/8	Ctn Wt	15	D \$558	E \$622
		COL Sq Ft	33	Cu Ft	3	F \$689	G \$785
						H \$886	I \$1,045
						J \$1,235	L1 \$854
						L2 \$969	

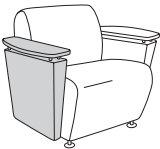
Modular Center Arm (arm only)	EN9221U-C <ul style="list-style-type: none"> · fully upholstered 	Dimensions		D	W	H	COM \$403
		Overall		23	6	25½	A \$417
		Upholstery		Shipping		B \$446	COL/C \$495
		COM Ydg	1 5/8	Ctn Wt	15	D \$558	E \$622
		COL Sq Ft	33	Cu Ft	3	F \$689	G \$785
						H \$886	I \$1,045
						J \$1,235	L1 \$854
						L2 \$969	

Modular End Arm (arm only)	EN9220UW-R EN9220UW-L <ul style="list-style-type: none"> · upholstered/wood arm · for use on right or left end (as seated in unit) · specify metal spacer color - Black Sandtex or Stardust Silver 	Dimensions		D	W	H	COM \$467
		Overall		23	7	24½	A \$480
 EN9220UW-R right	 EN9220UW-L left	Upholstery		Shipping		B \$507	COL/C \$552
		COM Ydg	1½	Ctn Wt	15	D \$611	E \$669
		COL Sq Ft	30	Cu Ft	3	F \$731	G \$819
						H \$913	I \$1,060
						J \$1,235	L1 \$884
						L2 \$990	

LOUNGE

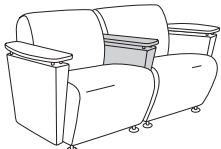
Description	Model	Specifications				List Price Per Grade	
		Dimensions	D	W	H	COM	COL/C
Modular Center Arm (arm only) 	EN9221UW-C · upholstered/wood · specify metal spacer color - Black Sandtex or Stardust Silver	Overall	23	6	24½	COM	\$467
		Upholstery		Shipping			
		COM Ydg	1½	Ctn Wt	15	A	\$480
		COL Sq Ft	30	Cu Ft	3	B	\$507
						C	\$552
						D	\$611
						E	\$669
						F	\$731
						G	\$819
						H	\$913
						I	\$1,060
						J	\$1,235
						L1	\$884
						L2	\$990

To Order, Specify:

- ❶ Model Number
- ❷ Wood Species - Maple (M)
- ❸ Wood Finish
- ❹ Fabric Selection - vendor, pattern and color
- ❺ Leg Style and Color
- ❻ Metal Color - Black Sandtex (BSX) or Stardust Silver (STS)
- ❼ Optional Coordinating Wood Grain Laminate Available on Wood Cap Arms or Tablet - no upcharge. Finishes with an asterisk have a coordinating laminate available.

❸ Wood Finish Options:

ALE Ale*	FLX Flax
AUB Auburn*	LGC Legacy*
AUT Autumn*	MCH Mocha*
BRL Barley*	NTO Night Owl*
BBN Bourbon*	PRL Praline*
BRG Brighton*	SAF Saffron*
BUT Butterscotch	SIE Sienna*
CIN Cinnamon*	TOF Toffee*
CLA Classic*	TRF Truffle*
EAR Earthy	VEN Venetian*
ESP Espresso	

- ❹ See a selection of graded in fabric manufacturers and patterns on pages 12-20. Contact Customer Service for additional fabric options.

Specifications

- Wood species - Maple.
- Upholstered arms have 4½" high density polyurethane foam.
- Wood caps and tablet are ¾" thick
- Plywood construction with spiral grooved solid wood dowels, glue and screws.
- Some assembly required.
- Linking bracket included.

Description	D	W	H	CTN WT	CU FT	① Model	List Price
Modular End Arm (arm only)	23	7	24½	7	2	EN9220W	\$231



- wood cap metal arm
- for use on right or left end of unit while sitting
- specify metal arm color - Black Sandtex or Stardust Silver

Tablet Arm (arm only)	13	13	24½	5	2	EN9230T-R	\$240
	13	13	24½	5	2	EN9230T-L	\$240



EN9230T-R
right

- attaches to right end of lounge or bench unit while sitting
- tablet features flat edge and 360° swivel
- specify metal arm color - Black Sandtex or Stardust Silver



EN9230T-L
left

22.5° Linking Table	23 ¼	16-26	17	15	3	EN22	\$628
---------------------	------	-------	----	----	---	------	-------



- 22.5° inside/outside
- attaches between lounge or bench units
- specify metal color - Black Sandtex or Stardust Silver

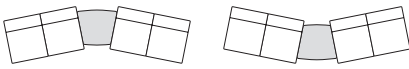

Front

LOUNGE

45° Linking Table	22	6-25	17	15	3	EN45	\$621
-------------------	----	------	----	----	---	------	-------



- 45° inside/outside
- attaches between lounge or bench units
- specify metal color - Black Sandtex or Stardust Silver

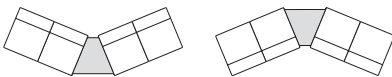

Front

Description	D	W	H	CTN WT	CU FT	① Model	List Price
Square Linking Table	23½	25	17	20	2	EN90	\$643



- used for straight run configurations
- attaches between lounge or bench units
- specify metal color - Black Sandtex or Stardust Silver

90° Corner Linking Table	25	46½	13½	25	4	EN90CT	\$807
--------------------------	----	-----	-----	----	---	--------	-------

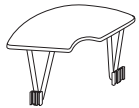

- 90° inside/outside
- attaches between lounge or bench units
- specify metal color - Black Sandtex or Stardust Silver

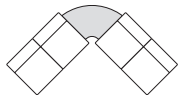

Front

To Order, Specify:



- ① Model Number
- ② Wood Species - Maple (M)
- ③ Wood Finish
- ④ Leg Style and Color
- ⑤ Metal Color - Black Sandtex (BSX) or Stardust Silver (STS)
- ⑥ Optional Coordinating Wood Grain Laminate Available on wood cap arms or tablet - no upcharge. Finishes with an asterisk have a coordinating laminate available

③ Wood Finish Options:

ALE Ale*	FLX Flax
AUB Auburn*	LGC Legacy*
AUT Autumn*	MCH Mocha*
BRL Barley*	NTO Night Owl*
BBN Bourbon*	PRL Praline*
BRG Brighton*	SAF Saffron*
BUT Butterscotch	SJE Sienna*
CIN Cinnamon*	TOF Toffee*
CLA Classic*	TRF Truffle*
EAR Earthy	VEN Venetian*
ESP Espresso	

Specifications

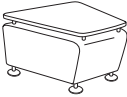
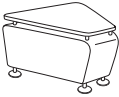
- Wood species - Maple.
- Wood caps and tablet are ¾" thick.
- Plywood construction with spiral grooved solid wood dowels, glue and screws.
- Some assembly required.
- Linking bracket included.
- Standard with nylon glides.

Description	① Model	Specifications				List Price Per Grade
		Dimensions	D	W	H	
22.5° Linking Table 	EN22B · 22.5° upholstered linking table · attaches to lounge or bench units · metal spacers will match leg color · overall width range is 16 ½ - 26 ½	Upholstery		Shipping		COM \$807
		Overall	27	26 ½	16	A \$822
		COM Ydg	1 ⅝	Ctn Wt	46	B \$850
		COL Sq Ft	33	Cu Ft	8	COL/C \$899
						D \$962
45° Linking Table 	EN45B · 45° upholstered linking table · attaches to lounge or bench units · metal spacers will match leg color · overall width range is 10 ½ - 26 ½	Upholstery		Shipping		COM \$784
		Overall	25 ½	26 ½	16	A \$798
		COM Ydg	1 ⅝	Ctn Wt	46	B \$827
		COL Sq Ft	33	Cu Ft	8	COL/C \$876
						D \$939
Square Linking Table 	EN90B · used for straight run configurations · upholstered square linking table · attaches to lounge or bench units · metal spacers will match leg color	Upholstery		Shipping		COM \$845
		Overall	25 ½	23 ½	16	A \$859
		COM Ydg	1 ⅝	Ctn Wt	46	B \$888
		COL Sq Ft	33	Cu Ft	8	COL/C \$937
						D \$1,000
				E \$1,064		
				F \$1,131		
				G \$1,227		
				H \$1,328		
				I \$1,487		
				J \$1,677		
				L1 \$1,296		
				L2 \$1,411		

LOUNGE

Description	D	W	H	CTN WT	CU FT	① Model	List Price
Mini Power Tilt Out	4 ¼	5 ½		6	1	EC11	\$367 ▲



- fluid one touch tilt up access
- two power receptacles - 120 volt; 15 amp
- 72" power cord with molded plug
- drop in field installation required
- located in side panel of Encore Lounge or Bench units without arms (indicate right or left side panel as seated in the unit)
- UL listed component
- available in Silver finish

Mini Power and USB Tilt Up	4 ¼	5 ½		6	1	EC12	\$458 ▲
----------------------------	-----	-----	--	---	---	------	---------



- fluid one touch tilt up access
- one power receptacle - 120 volt; 15 amp dual powered USB
- 72" power cord with molded plug
- drop in field installation required
- located in side panel of Encore Lounge or Bench units without arms (indicate right or left side panel as seated in the unit)
- UL listed component
- available in Silver finish

To Order, Specify:

- ① Model Number
- ② Wood Species - Maple (M)
- ③ Wood Finish
- ④ Fabric Selection - vendor, pattern and color
- ⑤ Leg Style and Color
- ⑥ Metal Color - Black Sandtex (BSX) or Stardust Silver (STS)
- ⑦ Optional Coordinating Wood Grain Laminate Available on Top Surface - no upcharge. Finishes with an asterisk have a coordinating laminate available

③ Wood Finish Options:

ALE Ale*	FLX Flax
AUB Auburn*	LGC Legacy*
AUT Autumn*	MCH Mocha*
BRL Barley*	NTO Night Owl*
BBN Bourbon*	PRL Praline*
BRG Brighton*	SAF Saffron*
BUT Butterscotch	SIE Sienna*
CIN Cinnamon*	TOF Toffee*
CLA Classic*	TRF Truffle*
EAR Earthy	VEN Venetian*
ESP Espresso	

- ④ See a selection of graded in fabric manufacturers and patterns on pages 12-20. Contact Customer Service for additional fabric options.

Specifications

- Wood species - Maple.
- Upholstered arms have 4 ½" high density polyurethane foam.
- Table tops are ¾" thick.
- Plywood construction with spiral grooved solid wood dowels, glue and screws.
- Some assembly required.
- Linking bracket included.
- Standard with nylon glides.

Finn Lounge Order Check List:



Specify:

- 1. Model Number
- 2. Wood Species - Cherry (C), Maple (M), White Oak (O) or Walnut (W)
- 3. Wood Finish
- 4. Fabric Selection - vendor, pattern and color
- 5. Table Tops - Glass (G) or Wood (W)
- 6. Optional Rubber Cushion Nylon Glides - no upcharge

Example:

F12311 | **C** | **CLC** | **MOMENTUM** | **VOX** | **MYSTIC**
 (model #) | (wood species) | (finish) | (fabric vendor) | (pattern name) | (pattern color)

1. Model Number

2. Wood Species - Cherry (C), Maple (M), White Oak (O), or Walnut (W)

3. Wood Finish Options:

- CLC Clear on Cherry
- CLM Clear on Maple
- CLK Clear on White Oak
- CLW Clear on Walnut

4. Fabric Selection - Please supply the following:

- Fabric vendor
- Pattern name
- Pattern color

When specifying contrasting upholstery, indicate clearly which upholstery is to be applied to the seat and back. Use higher grade pricing.

- Indicate direction of fabric - Railroaded or Up the Roll
- Please provide illustration, if available

All COM orders must include the following:

- Vendor's name, pattern name and color
- Sample of the fabric attached to order
- Model numbers of items for fabric application
- Special application instructions (e.g., all stripes will be applied front to back unless specified otherwise)
- Customer and purchase order number

Ship prepaid COM material to:

JSI
 Attn: COM Dept
 932 Mill Street
 Jasper, IN 47546

Application of fabric:
 Railroaded Up the Roll

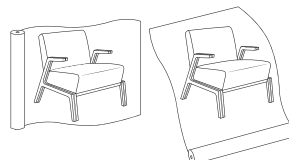

All COM orders will ship at standard lead time from receipt of COM except for orders requiring special custom matched finishes.

Description	① Model	Specifications				List Price Per Grade	
Single Seat 	FI2311 · cantilever arm	Dimensions	D	W	H	COM \$2,251 A \$2,273 B \$2,317 COL/C \$2,392 D \$2,490 E \$2,588 F \$2,691 G \$2,838 H \$2,994 I \$3,239 J \$3,532 L1 \$3,062 L2 \$3,268	
		Overall	30 ½	28	30 ¾		
		Seat	20 ½	24	16 ¾		
		Arm			22		
		Upholstery	Shipping				
		COM Ydg	2 ½	Ctn Wt	36		
		COL Sq Ft	58	Cu Ft	25		

Description	① Model	Specifications				List Price Per Grade	
Two Seat 	FI2312 · cantilever arm	Dimensions	D	W	H	COM \$2,907 A \$2,943 B \$3,012 COL/C \$3,134 D \$3,290 E \$3,447 F \$3,611 G \$3,846 H \$4,095 I \$4,487 J \$4,956 L1 \$4,206 L2 \$4,533	
		Overall	30 ½	51 ¾	30 ¾		
		Seat	20 ½	47 ¾	16 ¾		
		Arm			22		
		Upholstery	Shipping				
		COM Ydg	4	Ctn Wt	56		
		COL Sq Ft	92	Cu Ft	39		

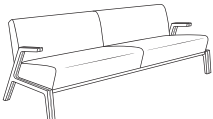
Description	① Model	Specifications				List Price Per Grade	
Three Seat 	FI2313 · cantilever arm	Dimensions	D	W	H	COM \$3,452 A \$3,510 B \$3,622 COL/C \$3,819 D \$4,073 E \$4,328 F \$4,596 G \$4,977 H \$5,384 I \$6,019 J \$6,781 L1 \$5,561 L2 \$6,095	
		Overall	30 ½	75 ½	30 ¾		
		Seat	20 ½	71 ½	16 ¾		
		Arm			22		
		Upholstery	Shipping				
		COM Ydg	6 ½	Ctn Wt	64		
		COL Sq Ft	150	Cu Ft	75		

To Order, Specify:

- ① Model Number
- ② Wood Species - Cherry (C), Maple (M), White Oak (O) or Walnut (W)
- ③ Wood Finish
- ④ Fabric Selection - vendor, pattern and color
- ⑤ Optional Rubber Cushion Nylon Glides - no upcharge





③ Wood Finish Options:

- CLC Clear on Cherry
- CLM Clear on Maple
- CLK Clear on White Oak
- CLW Clear on Walnut

- ④ See a selection of graded in fabric manufacturers and patterns on pages 12-20. Contact Customer Service for additional fabric options.

Specifications

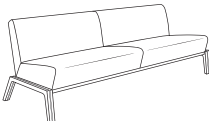
- Wood species - Cherry, Maple, White Oak or Walnut in clear finish.
- Seat has 3" high density polyurethane foam and synthetic sheet webbing with cross strap reinforcement.
- Back has 1 ½" high density polyurethane foam.
- Mortise and tenon construction with corner blocks, glue and screws.
- Internal aluminum core throughout the legs and arms.
- Features fixed cushions.
- Standard with rubber cushion metal glides.

Description	① Model	Specifications				List Price Per Grade
Single Seat 	F12321	Dimensions	D	W	H	COM \$1,608
		Overall	30 ½	28	30 ¾	A \$1,630
		Seat	20 ½	24	16 ¾	B \$1,674
		Arm				COL/C \$1,750
		Upholstery	Shipping			D \$1,847
		COM Ydg	2 ½	Ctn Wt	29	E \$1,945
		COL Sq Ft	58	Cu Ft	25	F \$2,048
						G \$2,195
						H \$2,351
						I \$2,596
				J \$2,889		
				L1 \$2,420		
				L2 \$2,625		
Two Seat 	F12322	Dimensions	D	W	H	COM \$2,263
		Overall	30 ½	51 ¾	30 ¾	A \$2,299
		Seat	20 ½	47 ¾	16 ¾	B \$2,368
		Arm				COL/C \$2,490
		Upholstery	Shipping			D \$2,646
		COM Ydg	4	Ctn Wt	49	E \$2,803
		COL Sq Ft	92	Cu Ft	39	F \$2,968
						G \$3,202
						H \$3,452
						I \$3,843
				J \$4,313		
				L1 \$3,562		
				L2 \$3,890		
Three Seat 	F12323	Dimensions	D	W	H	COM \$2,804
		Overall	30 ½	75 ½	30 ¾	A \$2,862
		Seat	20 ½	71 ½	16 ¾	B \$2,974
		Arm				COL/C \$3,171
		Upholstery	Shipping			D \$3,426
		COM Ydg	6 ½	Ctn Wt	68	E \$3,680
		COL Sq Ft	150	Cu Ft	64	F \$3,948
						G \$4,330
						H \$4,736
						I \$5,371
				J \$6,134		
				L1 \$4,913		
				L2 \$5,447		
Single Seat Bench 	F12331	Dimensions	D	W	H	COM \$1,419
		Overall	22 ¼	28	16 ¾	A \$1,433
		Seat	20 ½	24	16 ¾	B \$1,459
		Arm				COL/C \$1,504
		Upholstery	Shipping			D \$1,563
		COM Ydg	1 ½	Ctn Wt	22	E \$1,622
		COL Sq Ft	35	Cu Ft	13	F \$1,684
						G \$1,772
						H \$1,865
						I \$2,012
				J \$2,188		
				L1 \$1,906		
				L2 \$2,029		

LOUNGE

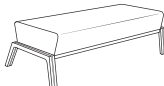
Description	① Model	Specifications				List Price Per Grade	
Two Seat Bench 	FI2332	Dimensions	D	W	H	COM	\$1,992
		Overall	22 ¼	51 ¾	16 ¾	A	\$2,014
		Seat	20 ½	47 ¾	16 ¾	B	\$2,058
		Arm				COL/C	\$2,134
		Upholstery		Shipping		D	\$2,232
		COM Ydg	2 ½	Ctn Wt	40	E	\$2,329
		COL Sq Ft	58	Cu Ft	20	F	\$2,432
						G	\$2,579
						H	\$2,736
						I	\$2,980
				J	\$3,273		
				L1	\$2,804		
				L2	\$3,010		

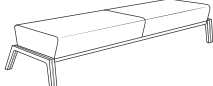
Description	① Model	Specifications				List Price Per Grade	
Three Seat Bench 	FI2333	Dimensions	D	W	H	COM	\$2,485
		Overall	22 ¼	75 ½	16 ¾	A	\$2,529
		Seat	20 ½	71 ½	16 ¾	B	\$2,616
		Arm				COL/C	\$2,768
		Upholstery		Shipping		D	\$2,964
		COM Ydg	5	Ctn Wt	57	E	\$3,159
		COL Sq Ft	115	Cu Ft	32	F	\$3,365
						G	\$3,659
						H	\$3,971
						I	\$4,460
				J	\$5,046		
				L1	\$4,108		
				L2	\$4,519		

To Order, Specify:

- ① Model Number
- ② Wood Species - Cherry (C), Maple (M), White Oak (O) or Walnut (W)
- ③ Wood Finish
- ④ Fabric Selection - vendor, pattern and color
- ⑤ Optional Rubber Cushion Nylon Glides - no upcharge

③ Wood Finish Options:

- CLC Clear on Cherry
- CLM Clear on Maple
- CLK Clear on White Oak
- CLW Clear on Walnut

- ④ See a selection of graded in fabric manufacturers and patterns on pages 12-20. Contact Customer Service for additional fabric options.

Specifications

- Wood species - Cherry, Maple, White Oak or Walnut in clear finish.
- Seat has 3" high density polyurethane foam and synthetic sheet webbing with cross strap reinforcement.
- Back has 1 ½" high density polyurethane foam.
- Mortise and tenon construction with corner blocks, glue and screws.
- Internal aluminum core throughout the legs and arms.
- Features fixed cushions.
- Standard with rubber cushion metal glides.

Description	D	W	H	CTN WT	CU FT	① Model	List Price
End Table	24	24	16	40	7	FI2424G	\$1,679



- glass top
- white back painted glass

End Table	28	20	16	39	7	FI2028G	\$1,691
-----------	----	----	----	----	---	---------	---------



- glass top
- white back painted glass

Coffee Table	42	42	16	111	20	FI4242G	\$2,870
--------------	----	----	----	-----	----	---------	---------

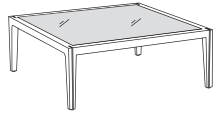

- glass top
- white back painted glass

Coffee Table	24	50	16	77	14	FI2450G	\$2,315
--------------	----	----	----	----	----	---------	---------

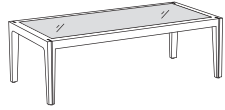

- glass top
- white back painted glass

Coffee Table	24	60	16	91	17	FI2460G	\$2,949
--------------	----	----	----	----	----	---------	---------

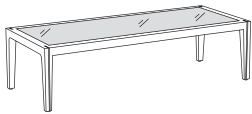

- glass top
- white back painted glass

LOUNGE

Description	D	W	H	CTN WT	CU FT	① Model	List Price
End Table	24	24	16	24	7	FI2424W	\$1,568



- wood top
- parquet veneer face

End Table	28	20	16	24	7	FI2028W	\$1,588
-----------	----	----	----	----	---	---------	---------



- wood top
- parquet veneer face

Coffee Table	42	42	16	62	20	FI4242W	\$2,238
--------------	----	----	----	----	----	---------	---------



- wood top
- parquet veneer face

Coffee Table	24	50	16	45	14	FI2450W	\$1,958
--------------	----	----	----	----	----	---------	---------



- wood top
- parquet veneer face

Coffee Table	24	60	16	52	17	FI2460W	\$2,486
--------------	----	----	----	----	----	---------	---------



- wood top
- parquet veneer face

To Order, Specify:

- ① Model Number
- ② Wood Species - Cherry (C), Maple (M), White Oak (O) or Walnut (W)
- ③ Wood Finish
- ④ Optional Rubber Cushion Nylon Glides - no upcharge

③ Wood Finish Options:

- CLC Clear on Cherry
- CLM Clear on Maple
- CLK Clear on White Oak
- CLW Clear on Walnut

Specifications

- Wood species - Cherry, Maple, White Oak or Walnut in clear finish.
- Internal aluminum core throughout the legs.
- Standard with nylon glides.

Finn Nu Lounge Order Check List:



- Specify:**
- 1. Model Number
 - 2. Wood Species - Maple (M)
 - 3. Wood Finish
 - 4. Fabric Selection - vendor, pattern and color
 - 5. Table Tops - Glass (G) or Wood (W)
 - 6. Optional Rubber Cushion Nylon Glides (Seating Only) - no upcharge

Example:

FI2351 | **M** | **AUB** | **MOMENTUM** | **VOX** | **MYSTIC**
 (model #) | (wood species) | (finish) | (fabric vendor) | (pattern name) | (pattern color)

1. Model Number

2. Wood Species - Maple (M)

3. Wood Finish Options:

ALE Ale	FLX Flax
AUB Auburn	LGC Legacy
AUT Autumn	MCH Mocha
BRL Barley	NTO Night Owl
BBN Bourbon	PRL Praline
BRG Brighton	SAF Saffron
BUT Butterscotch	SIE Sienna
CIN Cinnamon	TOF Toffee
CLA Classic	TRF Truffle
EAR Earthy	VEN Venetian
ESP Espresso	

4. Fabric Selection - Please supply the following:

- Fabric vendor
- Pattern name
- Pattern color

When specifying contrasting upholstery, indicate clearly which upholstery is to be applied to the seat and back. Use higher grade pricing.

- Indicate direction of fabric - Railroaded or Up the Roll
- Please provide illustration, if available

All COM orders must include the following:

- Vendor's name, pattern name and color
- Sample of the fabric attached to order
- Model numbers of items for fabric application
- Special application instructions (e.g., all stripes will be applied front to back unless specified otherwise)
- Customer and purchase order number

Ship prepaid COM material to:
 JSI
 Attn: COM Dept
 932 Mill Street
 Jasper, IN 47546

Application of fabric:
 Railroaded Up the Roll

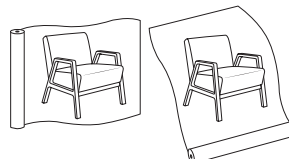

All COM orders will ship at standard lead time from receipt of COM except for orders requiring special custom matched finishes.

LOUNGE

Description	① Model	Specifications				List Price Per Grade	
		Dimensions	D	W	H	COM	
Single Seat 	FI2351 · arm	Overall	30 ½	27 ½	30 ¾	COM	\$1,195
		Seat	20 ½	24	16 ¾	A	\$1,217
		Arm			22	B	\$1,262
		Upholstery		Shipping		COL/C	\$1,337
		COM Ydg	2 ½	Ctn Wt	36	D	\$1,435
		COL Sq Ft	58	Cu Ft	25	E	\$1,532
						F	\$1,635
						G	\$1,782
						H	\$1,939
						I	\$2,183
				J	\$2,476		
				L1	\$2,007		
				L2	\$2,213		

Description	① Model	Specifications				List Price Per Grade	
		Dimensions	D	W	H	COM	
Two Seat 	FI2352 · arm	Overall	30 ½	51 ¼	30 ¾	COM	\$1,646
		Seat	20 ½	47 ¾	16 ¾	A	\$1,682
		Arm			22	B	\$1,751
		Upholstery		Shipping		COL/C	\$1,873
		COM Ydg	4	Ctn Wt	56	D	\$2,029
		COL Sq Ft	92	Cu Ft	39	E	\$2,186
						F	\$2,350
						G	\$2,585
						H	\$2,834
						I	\$3,226
				J	\$3,695		
				L1	\$2,945		
				L2	\$3,272		

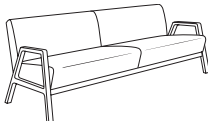
Description	① Model	Specifications				List Price Per Grade	
		Dimensions	D	W	H	COM	
Three Seat 	FI2353 · arm	Overall	30 ½	75	30 ¾	COM	\$2,100
		Seat	20 ½	71 ½	16 ¾	A	\$2,158
		Arm			22	B	\$2,271
		Upholstery		Shipping		COL/C	\$2,468
		COM Ydg	6 ½	Ctn Wt	64	D	\$2,722
		COL Sq Ft	150	Cu Ft	75	E	\$2,976
						F	\$3,245
						G	\$3,626
						H	\$4,032
						I	\$4,668
				J	\$5,430		
				L1	\$4,210		
				L2	\$4,743		

To Order, Specify:

- ① Model Number
- ② Wood Species - Maple (M)
- ③ Wood Finish
- ④ Fabric Selection - vendor, pattern and color
- ⑤ Optional Rubber Cushion Nylon Glides - no upcharge

③ Wood Finish Options:

- | | |
|------------------|---------------|
| ALE Ale | FLX Flax |
| AUB Auburn | LGC Legacy |
| AUT Autumn | MCH Mocha |
| BRL Barley | NTO Night Owl |
| BBN Bourbon | PRL Praline |
| BRG Brighton | SAF Saffron |
| BUT Butterscotch | SIE Sienna |
| CIN Cinnamon | TOF Toffee |
| CLA Classic | TRF Truffle |
| EAR Earthy | VEN Venetian |
| ESP Espresso | |

Specifications

- Wood species - Maple.
- Seat has 3" high density polyurethane foam and synthetic sheet webbing with cross strap reinforcement.
- Mortise and tenon construction with corner blocks, glue and screws
- Features fixed cushions.
- Standard with rubber cushion metal glides.

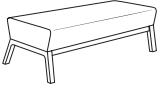
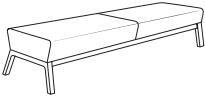
Description	① Model	Specifications				List Price Per Grade	
Single Seat Bench 	F12371	Dimensions		D	W	H	COM \$889
		Overall	22 ¼	24	16 ¾	A \$902	
		Seat	20 ½	24	16 ¾	B \$929	
		Upholstery		Shipping		COL/C \$974	
		COM Ydg	1 ½	Ctn Wt	22	D \$1,033	
		COL Sq Ft	35	Cu Ft	13	E \$1,091	
						F \$1,153	
				G \$1,242			
				H \$1,335			
				I \$1,482			
				J \$1,657			
				L1 \$1,376			
				L2 \$1,499			
Two Seat Bench 	F12372	Dimensions		D	W	H	COM \$1,183
		Overall	22 ¼	47 ¾	16 ¾	A \$1,205	
		Seat	20 ½	47 ¾	16 ¾	B \$1,249	
		Upholstery		Shipping		COL/C \$1,325	
		COM Ydg	2 ½	Ctn Wt	40	D \$1,422	
		COL Sq Ft	58	Cu Ft	20	E \$1,520	
						F \$1,623	
				G \$1,770			
				H \$1,926			
				I \$2,171			
				J \$2,464			
				L1 \$1,994			
				L2 \$2,200			
Three Seat Bench 	F12373	Dimensions		D	W	H	COM \$1,564
		Overall	22 ¼	71 ½	16 ¾	A \$1,608	
		Seat	20 ½	71 ½	16 ¾	B \$1,695	
		Upholstery		Shipping		COL/C \$1,847	
		COM Ydg	5	Ctn Wt	57	D \$2,043	
		COL Sq Ft	115	Cu Ft	32	E \$2,238	
						F \$2,444	
				G \$2,738			
				H \$3,050			
				I \$3,539			
				J \$4,125			
				L1 \$3,187			
				L2 \$3,598			

LOUNGE

Description	D	W	H	CTN WT	CU FT	① Model	List Price
End Table	24	24	16	40	8	FI2424PG	\$1,199



- glass top
- white back painted glass

End Table	28	20	16	39	7	FI2028PG	\$1,197
-----------	----	----	----	----	---	----------	---------



- glass top
- white back painted glass

Coffee Table	42	42	16	111	21	FI4242PG	\$2,208
--------------	----	----	----	-----	----	----------	---------



- glass top
- white back painted glass

Coffee Table	24	50	16	77	15	FI2450PG	\$1,714
--------------	----	----	----	----	----	----------	---------

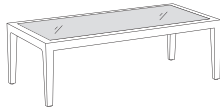

- glass top
- white back painted glass

Coffee Table	24	60	16	91	17	FI2460PG	\$1,882
--------------	----	----	----	----	----	----------	---------

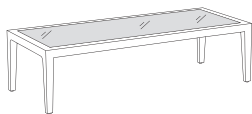

- glass top
- white back painted glass

To Order, Specify:

- ① Model Number
- ② Wood Species - Maple (M)
- ③ Wood Finish
- ④ Fabric Selection - vendor, pattern and color
- ⑤ Optional Rubber Cushion Nylon Glides (seating only) - no upcharge

③ Wood Finish Options:

ALE Ale	FLX Flax
AUB Auburn	LGC Legacy
AUT Autumn	MCH Mocha
BRL Barley	NTO Night Owl
BBN Bourbon	PRL Praline
BRG Brighton	SAF Saffron
BUT Butterscotch	SIE Sienna
CIN Cinnamon	TOF Toffee
CLA Classic	TRF Truffle
EAR Earthy	VEN Venetian
ESP Espresso	

- ④ See a selection of graded in fabric manufacturers and patterns on pages 12-20. Contact Customer Service for additional fabric options.

Seating Specifications

- Wood species - Maple.
- Seat has 3" high density polyurethane foam and synthetic sheet webbing with cross strap reinforcement.
- Mortise and tenon construction with corner blocks, glue and screws
- Features fixed cushions.
- Standard with rubber cushion metal glides.

Table Specifications

- Wood species - Maple.
- Standard with nylon glides.

Description	D	W	H	CTN WT	CU FT	① Model	List Price
End Table	24	24	16	24	8	FI2424PW	\$1,042



- wood top
- bookmatch maple veneer

End Table	28	20	16	24	7	FI2028PW	\$1,052
-----------	----	----	----	----	---	----------	---------



- wood top
- bookmatch maple veneer

Coffee Table	42	42	16	62	21	FI4242PW	\$1,382
--------------	----	----	----	----	----	----------	---------



- wood top
- bookmatch maple veneer

Coffee Table	24	50	16	45	15	FI2450PW	\$1,241
--------------	----	----	----	----	----	----------	---------

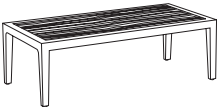

- wood top
- bookmatch maple veneer

Coffee Table	24	60	16	52	17	FI2460PW	\$1,272
--------------	----	----	----	----	----	----------	---------



- wood top
- bookmatch maple veneer

LOUNGE

To Order, Specify:

- ① Model Number
- ② Wood Species - Maple (M)
- ③ Wood Finish

③ Wood Finish Options:

ALE Ale	FLX Flax
AUB Auburn	LGC Legacy
AUT Autumn	MCH Mocha
BRL Barley	NTO Night Owl
BBN Bourbon	PRL Praline
BRG Brighton	SAF Saffron
BUT Butterscotch	SIE Sienna
CIN Cinnamon	TOF Toffee
CLA Classic	TRF Truffle
EAR Earthy	VEN Venetian
ESP Espresso	

Specifications

- Wood species - Maple.
- Standard with nylon glides.

Focus Lounge Order Check List:



Specify:

- 1. Model Number
- 2. Wood Species - Maple (M)
- 3. Wood Finish
- 4. Fabric Selection - vendor, pattern and color

Example:

FO4460 | M | AUB | MOMENTUM | VOX | MYSTIC
 (model #) | (wood species) | (finish) | (fabric vendor) | (pattern name) | (pattern color)

1. Model Number

2. Wood Species - Maple (M)

3. Wood Finish Options:

ALE Ale	FLX Flax
AUB Auburn	LGC Legacy
AUT Autumn	MCH Mocha
BRL Barley	NTO Night Owl
BBN Bourbon	PRL Praline
BRG Brighton	SAF Saffron
BUT Butterscotch	SIE Sienna
CIN Cinnamon	TOF Toffee
CLA Classic	TRF Truffle
EAR Earthy	VEN Venetian
ESP Espresso	

4. Fabric Selection - Please supply the following:

- Fabric vendor
- Pattern name
- Pattern color

When specifying contrasting upholstery, indicate clearly which upholstery is to be applied to the seat, back and arms. Use higher grade pricing.

- Indicate direction of fabric - Railroaded or Up the Roll
- Please provide illustration, if available

All COM orders must include the following:

- Vendor's name, pattern name and color
- Sample of the fabric attached to order
- Model numbers of items for fabric application
- Special application instructions (e.g., all stripes will be applied front to back unless specified otherwise)
- Customer and purchase order number

Ship prepaid COM material to:
 JSI
 Attn: COM Dept
 932 Mill Street
 Jasper, IN 47546

Application of fabric:
 Railroaded Up the Roll

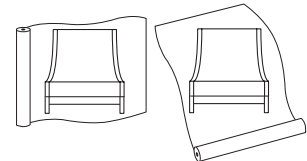

All COM orders will ship at standard lead time from receipt of COM except for orders requiring special custom matched finishes.

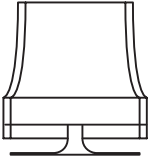
Description	① Model	Specifications				List Price Per Grade	
Single Seat 	F04450 · armless · pedestal swivel base with a return to center spring · Polished Aluminum base with nylon glides	Dimensions		D	W	H	COM \$1,973
		Overall	28 ¼	27 ¼	28		A \$1,987
		Seat	19 7/8	22 ½	16 ½		B \$2,013
		Upholstery		Shipping			COL/C \$2,058
		COM Ydg	1 ½	Ctn Wt	85		D \$2,117
		COL Sq Ft	27	Cu Ft	15		E \$2,176
							F \$2,238
							G \$2,326
							H \$2,420
							I \$2,567
							J \$2,742
							L1 \$2,343
							L2 \$2,438

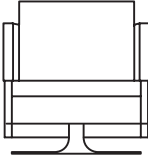
Single Seat 	F04456 · upholstered arms · pedestal swivel base with a return to center spring · Polished Aluminum base with nylon glides	Dimensions		D	W	H	COM \$2,431
		Overall	29 ¼	27 ¼	32 ½		A \$2,477
		Seat	18	21 ¾	20 ¼		B \$2,569
		Arm			28		COL/C \$2,728
		Upholstery		Shipping			D \$2,934
		COM Ydg	5 ¼	Ctn Wt	105		E \$3,139
		COL Sq Ft	95	Cu Ft	18		F \$3,355
							G \$3,663
							H \$3,992
							I \$4,505
							J \$5,120
							L1 \$3,725
							L2 \$4,053

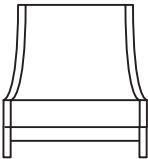
Single Seat 	F04460 · armless · Arctic Silver four leg base	Dimensions		D	W	H	COM \$2,099
		Overall	28 ¼	27 ¼	28		A \$2,113
		Seat	19 7/8	22 ½	16 ½		B \$2,139
		Upholstery		Shipping			COL/C \$2,184
		COM Ydg	1 ½	Ctn Wt	89		D \$2,243
		COL Sq Ft	27	Cu Ft	15		E \$2,302
							F \$2,364
							G \$2,452
							H \$2,546
							I \$2,693
							J \$2,868
							L1 \$2,469
							L2 \$2,564

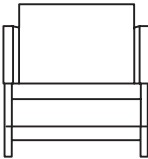
Single Seat 	F04466 · upholstered arms · Arctic Silver four leg base	Dimensions		D	W	H	COM \$2,590
		Overall	32 ½	27 ¼	32 ½		A \$2,636
		Seat	18	21 ¾	20 ¼		B \$2,727
		Arm			28		COL/C \$2,887
		Upholstery		Shipping			D \$3,093
		COM Ydg	5 ¼	Ctn Wt	109		E \$3,297
		COL Sq Ft	95	Cu Ft	18		F \$3,514
							G \$3,821
							H \$4,150
							I \$4,664
							J \$5,279
							L1 \$3,883
							L2 \$4,212

LOUNGE

Description	D	W	H	CTN WT	CU FT	① Model	List Price
Coffee Table	36	36	15	37	15	OCFT4436-15	\$1,725

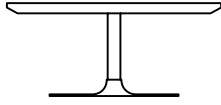

22" H End Table	24	24	22	27	10	ORT4424-22	\$1,293
-----------------	----	----	----	----	----	------------	---------

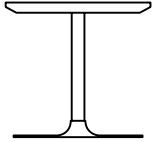

15" H End Table	24	24	15	25	7	ORT4424-15	\$1,278
-----------------	----	----	----	----	---	------------	---------

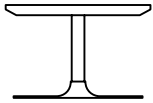

LOUNGE

To Order, Specify:

- ① Model Number
- ② Wood Species - Maple (M)
- ③ Wood Finish
- ④ Fabric Selection - vendor, pattern and color

③ Wood Finish Options:

ALE Ale	FLX Flax
AUB Auburn	LGC Legacy
AUT Autumn	MCH Mocha
BRL Barley	NTO Night Owl
BBN Bourbon	PRL Praline
BRG Brighton	SAF Saffron
BUT Butterscotch	SIE Sienna
CIN Cinnamon	TOF Toffee
CLA Classic	TRF Truffle
EAR Earthy	VEN Venetian
ESP Espresso	

- ④ See a selection of graded in fabric manufacturers and patterns on pages 12-20. Contact Customer Service for additional fabric options.

Specifications

- Wood species - Maple.
- Upholstered seat and back.
- Frame interior is APA certified upholstered grade plywood.
- Seat has synthetic sheet webbing with cross strap reinforcement and high resiliency seat polyurethane foam.
- Back has polypropylene webbing and polyurethane padding.
- Column pedestal for tables is Polished Aluminum with nylon glides.

Harbor Lounge Order Check List:



Specify:

- 1. Model Number
- 2. Wood Species - Maple (M)
- 3. Wood Finish
- 4. Fabric Selection - vendor, pattern and color
- 5. Optional Rubber Cushion Nylon Glides - no upcharge

Example:

HD2911 | **M** | **AUB** | **MOMENTUM** | **VOX** | **MYSTIC**
 (model #) | (wood species) | (finish) | (fabric vendor) | (pattern name) | (pattern color)

1. Model Number

2. Wood Species - Maple (M)

3. Wood Finish Options:[▲]

ALE Ale	FLX Flax
AUB Auburn	CGR Graphite Coordinate
AUT Autumn	CHL High Line Coordinate
BRL Barley	CKC Khaki Coordinate
CBE Blonde Echo Coordinate	LGC Legacy
BBN Bourbon	MCH Mocha
CBZ Brazilwood Coordinate	NTO Night Owl
BRG Brighton	PRL Praline
BUT Butterscotch	SAF Saffron
CIN Cinnamon	SIE Sienna
CLA Classic	CST Studio Teak Coordinate
CCF Coffee Coordinate	TOF Toffee
CCR Cremello Coordinate	TRF Truffle
EAR Earthy	VEN Venetian
ESP Espresso	CWH Walnut Heights Coordinate

4. Fabric Selection - Please supply the following:

- Fabric vendor
- Pattern name
- Pattern color

When specifying contrasting upholstery, indicate clearly which upholstery is to be applied to the seat, back and arms. Use higher grade pricing.

- Indicate direction of fabric - Railroaded or Up the Roll
- Please provide illustration, if available

All COM orders must include the following:

- Vendor's name, pattern name and color
- Sample of the fabric attached to order
- Model numbers of items for fabric application
- Special application instructions (e.g., all stripes will be applied front to back unless specified otherwise)
- Customer and purchase order number

Ship prepaid COM material to:
 JSI
 Attn: COM Dept
 932 Mill Street
 Jasper, IN 47546

Application of fabric:
 Railroaded Up the Roll

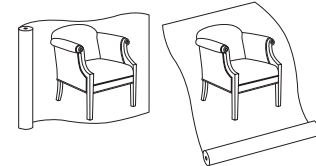

All COM orders will ship at standard lead time from receipt of COM except for orders requiring special custom matched finishes.

5. Optional Rubber Cushion Nylon Glides - no upcharge

For Harbor Swivel Seating, see page 39.

For Harbor Guest Seating, see page 96.

Description	Model	Specifications				List Price Per Grade
Club Chair 	HB2911	Dimensions	D	W	H	COM \$1,588
		Overall	30 ½	28 ½	34 ½	A \$1,641
		Seat	19 ¼	18 ½	17 ½	B \$1,746
		Arm			29	COL/C \$1,927
		Upholstery	Shipping			D \$2,162
		COM Ydg	6	Ctn Wt	70	E \$2,397
		COL Sq Ft	120	Cu Ft	31	F \$2,644
						G \$2,996
						H \$3,371
						I \$3,958
				J \$4,661		
				L1 \$3,254		
				L2 \$3,677		

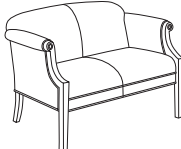
Description	Model	Specifications				List Price Per Grade
Loveseat 	HB2912	Dimensions	D	W	H	COM \$2,040
		Overall	30 ½	52 ½	34 ½	A \$2,114
		Seat	19 ¼	42 ½	17 ½	B \$2,262
		Arm			29	COL/C \$2,520
		Upholstery	Shipping			D \$2,852
		COM Ydg	8 ½	Ctn Wt	95	E \$3,185
		COL Sq Ft	170	Cu Ft	51	F \$3,536
						G \$4,035
						H \$4,566
						I \$5,396
				J \$6,394		
				L1 \$4,400		
				L2 \$4,997		

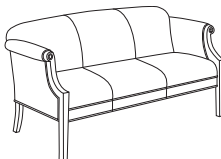
Description	Model	Specifications				List Price Per Grade
Sofa 	HB2913	Dimensions	D	W	H	COM \$2,602
		Overall	30 ½	76 ½	34 ½	A \$2,699
		Seat	19 ¼	66 ½	17 ½	B \$2,890
		Arm			29	COL/C \$3,225
		Upholstery	Shipping			D \$3,654
		COM Ydg	11	Ctn Wt	125	E \$4,085
		COL Sq Ft	220	Cu Ft	74	F \$4,539
						G \$5,183
						H \$5,871
						I \$6,946
				J \$8,237		
				L1 \$5,657		
				L2 \$6,430		

To Order, Specify:

- 1 Model Number
- 2 Wood Species - Maple (M)
- 3 Wood Finish
- 4 Fabric Selection - vendor, pattern and color
- 5 Optional Rubber Cushion Nylon Glides - no upcharge

3 Wood Finish Options: ▲

ALE Ale	FLX Flax
AUB Auburn	CGR Graphite Coordinate
AUT Autumn	CHL High Line Coordinate
BRL Barley	CKC Khaki Coordinate
CBE Blonde Echo Coordinate	LGC Legacy
BBN Bourbon	MCH Mocha
CBZ Brazilwood Coordinate	NTO Night Owl
BRG Brighton	PRL Praline
BUT Butterscotch	SAF Saffron
CIN Cinnamon	SIE Sienna
CLA Classic	CST Studio Teak Coordinate
CCF Coffee Coordinate	TOF Toffee
CCR Cremello Coordinate	TRF Truffle
EAR Earthy	VEN Venetian
ESP Espresso	CWH Walnut Heights Coordinate

4 See a selection of graded in fabric manufacturers and patterns on pages 12-20. Contact Customer Service for additional fabric options.

Specifications

- Wood species - Maple.
- Seat has synthetic sheet webbing with cross strap reinforcement and 3 ½" polyurethane high density foam.
- Back has synthetic sheet webbing and 3 ½" polyurethane high density foam.
- Arms have ½" polyurethane foam.
- Spiral grooved hardwood dowels with corner blocks, glue and screws.
- Standard with rubber cushion metal glides.

Hedron Lounge Order Check List:



Specify:

- 1. Model Number
- 2. Wood Species - Maple (M)
- 3. Wood Finish
- 4. Fabric Selection - vendor, pattern and color
- 5. Optional Veneer Wrapped Leg (V) - add \$216 list
- 6. Optional Tablet Arm - add \$491 list; indicate left (TBL) or right (TBR)
- 7. Optional Coordinating Wood Grain Laminate Surfaces - no upcharge
- 8. Optional Felt Glide Covers - no upcharge

Example:

HN5301W | M | AUB | MOMENTUM | VOX | MYSTIC
 (model #) | (wood species) | (finish) | (fabric vendor) | (pattern name) | (pattern color)

1. Model Number

2. Wood Species - Maple (M)

3. Wood Finish Options:

ALE Ale*	FLX Flax
AUB Auburn*	LGC Legacy*
AUT Autumn*	MCH Mocha*
BRL Barley*	NTO Night Owl*
BBN Bourbon*	PRL Praline*
BRG Brighton*	SAF Saffron*
BUT Butterscotch	SIE Sienna*
CIN Cinnamon*	TOF Toffee*
CLA Classic*	TRF Truffle*
EAR Earthy	VEN Venetian*
ESP Espresso	

4. Fabric Selection - Please supply the following:

- Fabric vendor
- Pattern name
- Pattern color

When specifying contrasting upholstery, indicate clearly which upholstery is to be applied to the seat, back and arms. Use higher grade pricing.

- Indicate direction of fabric - Railroaded or Up the Roll
- Please provide illustration, if available

All COM orders must include the following:

- Vendor's name, pattern name and color
- Sample of the fabric attached to order
- Model numbers of items for fabric application
- Special application instructions (e.g., all stripes will be applied front to back unless specified otherwise)
- Customer and purchase order number

Ship prepaid COM material to:

JSI
 Attn: COM Dept
 932 Mill Street
 Jasper, IN 47546

Application of fabric:
 Railroaded Up the Roll

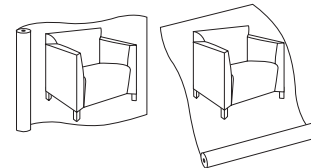

All COM orders will ship at standard lead time from receipt of COM except for orders requiring special custom matched finishes.

5. Optional Veneer Wrapped Leg (V) - add \$216 list; both come standard with nylon glide
 Standard leg - 5 1/2" tall
 Grand leg - 4" tall

6. Tablet Arm -

Tablet arm designated right or left as seated in chair - add \$491 list

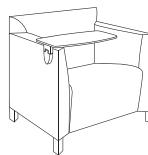

***7. Optional Coordinating Wood Grain Laminate Table Top - no upcharge; tables only. Finishes with an asterisk (*) have a coordinating laminate available.**

8. Optional Felt Glide Covers - no upcharge

LOUNGE

STANDARD SCALE

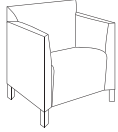
Description	Model	Specifications				List Price Per Grade	
Single Seat	HN5301U	Dimensions	D	W	H	COM	\$1,508
		Overall	26½	28	31	A	\$1,548
		Seat	20	20	18½	B	\$1,626
		Arm			26½	COL/C	\$1,763
		Upholstery	Shipping			D	\$1,939
		COM Ydg	4½	Ctn Wt	58	E	\$2,115
		COL Sq Ft	90	Cu Ft	30	F	\$2,301
						G	\$2,565
						H	\$2,846
						I	\$3,286
						J	\$3,813
					L1	\$2,758	
					L2	\$3,075	

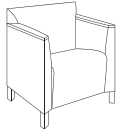
Description	Model	Specifications				List Price Per Grade	
Single Seat with Wood Cap Arm	HN5301W	Dimensions	D	W	H	COM	\$1,662
		Overall	26½	28	31	A	\$1,701
		Seat	20	20	18½	B	\$1,779
		Arm			26½	COL/C	\$1,917
		Upholstery	Shipping			D	\$2,092
		COM Ydg	4½	Ctn Wt	62	E	\$2,268
		COL Sq Ft	90	Cu Ft	30	F	\$2,454
						G	\$2,718
						H	\$2,999
						I	\$3,439
						J	\$3,966
					L1	\$2,911	
					L2	\$3,228	

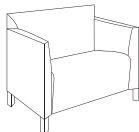
Description	Model	Specifications				List Price Per Grade	
31" Single Seat	HN5311U	Dimensions	D	W	H	COM	\$1,752
		Overall	26½	38	31	A	\$1,796
		Seat	20	30	18½	B	\$1,883
		Arm			26½	COL/C	\$2,035
		Upholstery	Shipping			D	\$2,231
		COM Ydg	5	Ctn Wt	69	E	\$2,426
		COL Sq Ft	115	Cu Ft	33	F	\$2,632
						G	\$2,926
						H	\$3,238
						I	\$3,727
						J	\$4,313
					L1	\$3,375	
					L2	\$3,786	

To Order, Specify:

- Model Number
- Wood Species - Maple (M)
- Wood Finish
- Fabric Selection - vendor, pattern and color
- Optional Veneer Wrapped Legs (V) - add \$216 list
- Optional Tablet Arm - add \$491 list; indicate left (TBL) or right (TBR)



Tilt and Stow
Tablet Arm Illustration
10"D x 16"W Surface
- Optional Coordinating Wood Grain Laminate Surfaces - no upcharge. Finishes with an asterisk have a coordinating laminate available.
- Optional Felt Glide Covers - no upcharge

Wood Finish Options:

ALE Ale*	FLX Flax
AUB Auburn*	LGC Legacy*
AUT Autumn*	MCH Mocha*
BRL Barley*	NTO Night Owl*
BBN Bourbon*	PRL Praline*
BRG Brighton*	SAF Saffron*
BUT Butterscotch	SIE Sienna*
CIN Cinnamon*	TOF Toffee*
CLA Classic*	TRF Truffle*
EAR Earthy	VEN Venetian*
ESP Espresso	

- See a selection of graded in fabric manufacturers and patterns on pages 12-20. Contact Customer Service for additional fabric options.

Specifications

- Frame: Solid Birch plywood
- Standard scale leg is 5½" tall.
- Mortise and tenon construction with corner blocks, glue and screws.
- Anodized aluminum extruded leg.
- Seat has synthetic sheet webbing with cross strip webs, 3" polyurethane foam with Dacron® wrap.
- Back has synthetic sheet webbing, 2" polyurethane foam with Dacron® wrap.
- Arms have ¼" polyurethane foam.
- Wood caps are ¾" thick maple veneer.
- Linking bracket, see page 325.
- Standard with nylon glides.

When ordering Quickship products, place a "Q" in front of model number. Example: QGT4901D

NOW!
Need it.
JSI Quickship

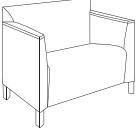
Description	① Model	Specifications			List Price Per Grade	
		Dimensions	D	W		H
31" Single Seat with Wood Cap Arm 	HN5311W	Overall	26 ½	38	31	COM \$1,904
		Seat	20	30	18 ½	A \$1,948
		Arm			26 ½	B \$2,035
		Upholstery		Shipping		COL/C \$2,188
		COM Ydg	5	Ctn Wt	73	D \$2,383
		COL Sq Ft	115	Cu Ft	33	E \$2,578
						F \$2,784
						G \$3,078
						H \$3,390
						I \$3,879
				J \$4,465		
				L1 \$3,527		
				L2 \$3,938		

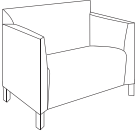
Description	① Model	Specifications			List Price Per Grade	
		Dimensions	D	W		H
31" Single Seat  <ul style="list-style-type: none"> · bariatric · 600 lb load rated 	HN5311BU	Overall	26 ½	38	31	COM \$2,215
		Seat	20	30	18 ½	A \$2,259
		Arm			26 ½	B \$2,346
		Upholstery		Shipping		COL/C \$2,498
		COM Ydg	5	Ctn Wt	74	D \$2,694
		COL Sq Ft	115	Cu Ft	33	E \$2,889
						F \$3,095
						G \$3,389
						H \$3,701
						I \$4,190
				J \$4,776		
				L1 \$3,838		
				L2 \$4,249		

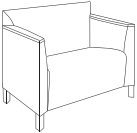
Description	① Model	Specifications			List Price Per Grade	
		Dimensions	D	W		H
31" Single Seat with Wood Cap Arm  <ul style="list-style-type: none"> · bariatric · 600 lb load rated 	HN5311BW	Overall	26 ½	38	31	COM \$2,367
		Seat	20	30	18 ½	A \$2,411
		Arm			26 ½	B \$2,498
		Upholstery		Shipping		COL/C \$2,651
		COM Ydg	5	Ctn Wt	78	D \$2,846
		COL Sq Ft	115	Cu Ft	33	E \$3,041
						F \$3,247
						G \$3,541
						H \$3,853
						I \$4,342
				J \$4,928		
				L1 \$3,990		
				L2 \$4,401		

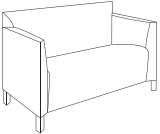
Description	① Model	Specifications			List Price Per Grade	
		Dimensions	D	W		H
Double Seat 	HN5302U	Overall	26 ½	49	31	COM \$1,945
		Seat	20	41	18 ½	A \$1,995
		Arm			26 ½	B \$2,095
		Upholstery		Shipping		COL/C \$2,271
		COM Ydg	5 ¾	Ctn Wt	80	D \$2,495
		COL Sq Ft	133	Cu Ft	46	E \$2,720
						F \$2,957
						G \$3,294
						H \$3,654
						I \$4,216
				J \$4,890		
				L1 \$3,812		
				L2 \$4,283		

LOUNGE

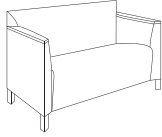
Description	Model	Specifications			List Price Per Grade		
		Dimensions	D	W	H	COM	
Double Seat with Wood Cap Arm 	HN5302W • bariatric • 600 lb load rated	Overall	26 1/2	49	31	COM	\$2,099
		Seat	20	41	18 1/2	A	\$2,150
		Arm			26 1/2	B	\$2,250
		Upholstery		Shipping		COL/C	\$2,425
		COM Ydg	5 3/4	Ctn Wt	84	D	\$2,650
		COL Sq Ft	133	Cu Ft	46	E	\$2,874
						F	\$3,112
						G	\$3,449
						H	\$3,809
						I	\$4,371

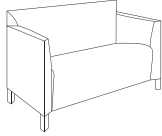
Description	Model	Specifications			List Price Per Grade		
		Dimensions	D	W	H	COM	
Double Seat 	HN5302BU • bariatric • 600 lb load rated	Overall	26 1/2	49	31	COM	\$2,408
		Seat	20	41	18 1/2	A	\$2,459
		Arm			26 1/2	B	\$2,558
		Upholstery		Shipping		COL/C	\$2,734
		COM Ydg	5 3/4	Ctn Wt	85	D	\$2,958
		COL Sq Ft	133	Cu Ft	46	E	\$3,183
						F	\$3,420
						G	\$3,757
						H	\$4,118
						I	\$4,679

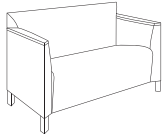
Description	Model	Specifications			List Price Per Grade		
		Dimensions	D	W	H	COM	
Double Seat with Wood Cap Arm 	HN5302BW • bariatric • 600 lb load rated	Overall	26 1/2	49	31	COM	\$2,561
		Seat	20	41	18 1/2	A	\$2,612
		Arm			26 1/2	B	\$2,712
		Upholstery		Shipping		COL/C	\$2,887
		COM Ydg	5 3/4	Ctn Wt	89	D	\$3,112
		COL Sq Ft	133	Cu Ft	46	E	\$3,336
						F	\$3,574
						G	\$3,911
						H	\$4,271
						I	\$4,833

To Order, Specify:

- Model Number
- Wood Species - Maple (M)
- Wood Finish
- Fabric Selection - vendor, pattern and color
- Optional Veneer Wrapped Legs (V) - add \$216 list
- Optional Tablet Arm - add \$491 list; indicate left (TBL) or right (TBR)



Tilt and Stow
Tablet Arm Illustration
10"D x 16"W Surface
- Optional Coordinating Wood Grain Laminate Surfaces - no upcharge. Finishes with an asterisk have a coordinating laminate available.
- Optional Felt Glide Covers - no upcharge

Wood Finish Options:

ALE Ale*	FLX Flax
AUB Auburn*	LGC Legacy*
AUT Autumn*	MCH Mocha*
BRL Barley*	NTO Night Owl*
BBN Bourbon*	PRL Praline*
BRG Brighton*	SAF Saffron*
BUT Butterscotch	SIE Sienna*
CIN Cinnamon*	TOF Toffee*
CLA Classic*	TRF Truffle*
EAR Earthy	VEN Venetian*
ESP Espresso	

- See a selection of graded in fabric manufacturers and patterns on pages 12-20. Contact Customer Service for additional fabric options.

Specifications

- Frame: Solid Birch plywood
- Standard scale leg is 5 1/2" tall.
- Mortise and tenon construction with corner blocks, glue and screws.
- Anodized aluminum extruded leg.
- Seat has synthetic sheet webbing with cross strip webs, 3" polyurethane foam with Dacron® wrap.
- Back has synthetic sheet webbing, 2" polyurethane foam with Dacron® wrap.
- Arms have 1/4" polyurethane foam.
- Wood caps are 3/4" thick maple veneer.
- Linking bracket, see page 325.
- Standard with nylon glides.

When ordering Quickship products, place a "Q" in front of model number.
Example: QGT4901D

NOW!
Need it.
JSI Quickship

STANDARD LINKING TABLES, TOP MOUNTED

Description	D	W	H	CTN WT	CU FT	Model	List Price
20" Linking End Table	24 3/4	20	17	19	4	HN53E2T	\$572



20" Linking Center Table	24 3/4	20	17	19	4	HN53C2T	\$411
--------------------------	--------	----	----	----	---	---------	-------



90° Linking Straight L Table	24 3/4	24 3/4	17	23	6	HN53CLST	\$519
------------------------------	--------	--------	----	----	---	----------	-------



90° Linking Radius L Table	24	24	17	15	6	HN53CLRT	\$411
----------------------------	----	----	----	----	---	----------	-------



90° Linking T Table	24 3/4	24 3/4	17	23	6	HN53CTT	\$411
---------------------	--------	--------	----	----	---	---------	-------



90° Linking X Table	24 3/4	24 3/4	17	23	6	HN53CXT	\$411
---------------------	--------	--------	----	----	---	---------	-------



22.5° Linking Table	24 3/4	18 1/4	17	12	4	HN53C22T	\$411
---------------------	--------	--------	----	----	---	----------	-------



· overall width range is 9 - 18 1/4

30° Linking Table	24 3/4	21 3/16	17	13	4	HN53C30T	\$411
-------------------	--------	---------	----	----	---	----------	-------



· overall width range is 9 - 21 3/16









45° Linking Table	24 3/4	27	17	17	6	HN53C45T	\$411
-------------------	--------	----	----	----	---	----------	-------



· overall width range is 9 - 27

LOUNGE

STANDARD LINKING TABLES, LEG MOUNTED

Description	D	W	H	CTN WT	CU FT	① Model	List Price
20" Linking End Table 	24 3/4	20	17	25	4	HN53E2L	\$703
20" Linking Center Table 	24 3/4	20	17	25	4	HN53C2L	\$703
90° Linking Straight L Table 	24 3/4	24 3/4	17	27	6	HN53CLSL	\$703
90° Linking T Table 	24 3/4	24 3/4	17	27	6	HN53CTL	\$703
90° Linking X Table 	24 3/4	24 3/4	17	27	6	HN53CXL	\$703
22.5° Linking Table  · overall width range is 9 - 18 1/4	24 3/4	18 1/4	17	18	4	HN53C22L	\$703
30° Linking Table  · overall width range is 9 - 21 3/16	24 3/4	21 3/16	17	19	4	HN53C30L	\$703
45° Linking Table  · overall width range is 9 - 27	24 3/4	27	17	23	6	HN53C45L	\$703



Linking Bracket Application

To Order, Specify:

- ① Model Number
- ② Wood Species - Maple (M)
- ③ Wood Finish
- ④ Optional Veneer Wrapped Legs (V) - add \$216 list
- ⑥ Optional Coordinating Wood Grain Laminate
Surfaces - no upcharge. Finishes with an asterisk have a coordinating laminate available.
- ⑧ Optional Felt Glide Covers - no upcharge

③ Wood Finish Options:

ALE Ale*	FLX Flax
AUB Auburn*	LGC Legacy*
AUT Autumn*	MCH Mocha*
BRL Barley*	NTO Night Owl*
BBN Bourbon*	PRL Praline*
BRG Brighton*	SAF Saffron*
BUT Butterscotch	SIE Sienna*
CIN Cinnamon*	TOF Toffee*
CLA Classic*	TRF Truffle*
EAR Earthy	VEN Venetian*
ESP Espresso	

- ④ See a selection of graded in fabric manufacturers and patterns on pages 12-20. Contact Customer Service for additional fabric options.

Specifications

- Wood species - Maple veneer.
- Table tops are 7/8" thick.
- Anodized aluminum extruded leg.
- Linking bracket, see page 325.
- Standard with nylon glides.

FREESTANDING TABLES

Description	D	W	H	CTN WT	CU FT	Model	List Price
24" x 24" End Table	24 3/4	24 3/4	17	27	6	HN2424-17	\$703

NOW!

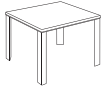

30" x 30" End Table	28 1/4	28 1/4	17	33	6	HN3030-17	\$819
---------------------	--------	--------	----	----	---	-----------	-------

NOW!

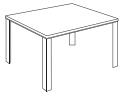

36" x 36" End Table	36	36	17	46	8	HN3636-17	\$874
---------------------	----	----	----	----	---	-----------	-------

NOW!

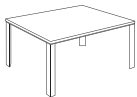

GRAND SCALE

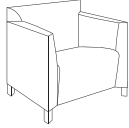
Description	Model	Specifications			List Price Per Grade	
	HN5321U	Dimensions	D	W	H	COM \$1,683
		Overall	30	32	30	A \$1,735
		Seat	21	22½	18½	B \$1,840
		Arm			26½	COL/C \$2,022
		Upholstery	Shipping			D \$2,257
		COM Ydg	6	Ctn Wt	71	E \$2,491
		COL Sq Ft	120	Cu Ft	30	F \$2,739
						G \$3,091
						H \$3,465
						I \$4,052
				J \$4,756		
				L1 \$3,349		
				L2 \$3,771		

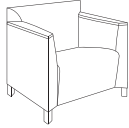
Description	Model	Specifications			List Price Per Grade	
	HN5321W	Dimensions	D	W	H	COM \$1,845
		Overall	30	32	30	A \$1,898
		Seat	21	22½	18½	B \$2,003
		Arm			26½	COL/C \$2,184
		Upholstery	Shipping			D \$2,420
		COM Ydg	6	Ctn Wt	75	E \$2,654
		COL Sq Ft	120	Cu Ft	30	F \$2,902
						G \$3,253
						H \$3,628
						I \$4,215
				J \$4,919		
				L1 \$3,512		
				L2 \$3,934		

To Order, Specify:

- 1 Model Number
- 2 Wood Species - Maple (M)
- 3 Wood Finish
- 4 Fabric Selection - vendor, pattern and color
- 5 Optional Veneer Wrapped Legs (V) - add \$216 list
- 6 Optional Tablet Arm - add \$491 list; indicate left (TBL) or right (TBR)



Tilt and Stow
Tablet Arm Illustration
10"D x 16"W Surface
- 7 Optional Coordinating Wood Grain Laminate Surfaces - no upcharge. Finishes with an asterisk have a coordinating laminate available.
- 8 Optional Felt Glide Covers - no upcharge

3 Wood Finish Options:

ALE Ale*	FLX Flax
AUB Auburn*	LGC Legacy*
AUT Autumn*	MCH Mocha*
BRL Barley*	NTO Night Owl*
BBN Bourbon*	PRL Praline*
BRG Brighton*	SAF Saffron*
BUT Butterscotch	SIE Sienna*
CIN Cinnamon*	TOF Toffee*
CLA Classic*	TRF Truffle*
EAR Earthy	VEN Venetian*
ESP Espresso	

- 4 See a selection of graded in fabric manufacturers and patterns on pages 12-20. Contact Customer Service for additional fabric options.

Specifications

- Frame: Solid Birch plywood
- Grand scale leg is 4" tall.
- Mortise and tenon construction with corner blocks, glue and screws.
- Anodized aluminum extruded leg.
- Seat has synthetic sheet webbing with cross strip webs, 3" polyurethane foam with Dacron® wrap.
- Back has synthetic sheet webbing, 2" polyurethane foam with Dacron® wrap.
- Arms have ¼" polyurethane foam.
- Table tops are 7/8" thick and wood caps are ¾" thick maple veneer.
- Linking bracket, see page 325.
- Standard with nylon glides.





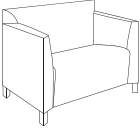
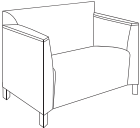
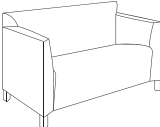
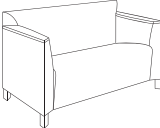

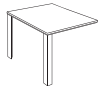

When ordering Quickship products, place a "Q" in front of model number.
Example: QGT4901D

NOW!
Need it.
JSI Quickship

Description	① Model	Specifications				List Price Per Grade
31" Single Seat 	HN5331U	Dimensions				COM \$1,925
			D	W	H	A \$1,980
		Overall	30	40	30	B \$2,089
		Seat	21	30	18½	COL/C \$2,279
		Arm			26½	D \$2,524
		Upholstery		Shipping		E \$2,767
		COM Ydg	6¼	Ctn Wt	82	F \$3,026
		COL Sq Ft	144	Cu Ft	33	G \$3,392
						H \$3,783
						I \$4,394
				J \$5,127		
				L1 \$3,954		
				L2 \$4,467		
31" Single Seat with Wood Cap Arm 	HN5331W	Dimensions				COM \$2,087
			D	W	H	A \$2,141
		Overall	30	40	30	B \$2,251
		Seat	21	30	18½	COL/C \$2,441
		Arm			26½	D \$2,685
		Upholstery		Shipping		E \$2,929
		COM Ydg	6¼	Ctn Wt	87	F \$3,187
		COL Sq Ft	144	Cu Ft	33	G \$3,554
						H \$3,944
						I \$4,555
				J \$5,288		
				L1 \$4,115		
				L2 \$4,629		
Double Seat 	HN5332U	Dimensions				COM \$2,118
			D	W	H	A \$2,180
		Overall	30	51	30	B \$2,302
		Seat	21	41	18½	COL/C \$2,514
		Arm			26½	D \$2,788
		Upholstery		Shipping		E \$3,061
		COM Ydg	7	Ctn Wt	93	F \$3,351
		COL Sq Ft	161	Cu Ft	46	G \$3,761
						H \$4,198
						I \$4,883
				J \$5,704		
				L1 \$4,391		
				L2 \$4,965		
Double Seat with Wood Cap Arm 	HN5332W	Dimensions				COM \$2,282
			D	W	H	A \$2,344
		Overall	30	51	30	B \$2,466
		Seat	21	41	18½	COL/C \$2,678
		Arm			26½	D \$2,952
		Upholstery		Shipping		E \$3,225
		COM Ydg	7	Ctn Wt	97	F \$3,515
		COL Sq Ft	161	Cu Ft	46	G \$3,924
						H \$4,362
						I \$5,047
				J \$5,868		
				L1 \$4,554		
				L2 \$5,129		

LOUNGE

GRAND LINKING TABLES, TOP MOUNTED

Description	D	W	H	CTN WT	CU FT	① Model	List Price
20" Linking End Table 	28 1/4	20	17	21	4	HN53E2GT	\$590
20" Linking Center Table 	28 1/4	20	17	21	4	HN53C2GT	\$425
90° Linking Straight L Table 	28 1/4	28 1/4	17	25	6	HN53CLGST	\$534
90° Linking Radius L Table 	27 1/2	27 1/2	17	17	6	HN53CLGRT	\$425
90° Linking T Table 	28 1/4	28 1/4	17	25	6	HN53CTGT	\$425
90° Linking X Table 	28 1/4	28 1/4	17	25	6	HN53CXGT	\$425
22.5° Linking Table 	28 1/4	19 5/16	17	14	4	HN53C22GT	\$425
						· overall width range is 9 - 19 5/16	
30° Linking Table 	28 1/4	23	17	15	4	HN53C30GT	\$425
						· overall width range is 9 - 23	
45° Linking Table 	28 1/4	29 5/8	17	19	6	HN53C45GT	\$425
						· overall width range is 9 - 29 5/8	

To Order, Specify:

- ① Model Number
- ② Wood Species - Maple (M)
- ③ Wood Finish
- ④ Fabric Selection - vendor, pattern and color
- ⑤ Optional Veneer Wrapped Legs (V) - add \$216 list
- ⑥ Optional Tablet Arm - add \$491 list; indicate left (TBL) or right (TBR)
 Tilt and Stow
Tablet Arm Illustration
10"D x 16"W Surface
- ⑦ Optional Coordinating Wood Grain Laminate Surfaces - no upcharge. Finishes with an asterisk have a coordinating laminate available.
- ⑧ Optional Felt Glide Covers - no upcharge

③ Wood Finish Options:

ALE Ale*	FLX Flax
AUB Auburn*	LGC Legacy*
AUT Autumn*	MCH Mocha*
BRL Barley*	NTO Night Owl*
BBN Bourbon*	PRL Praline*
BRG Brighton*	SAF Saffron*
BUT Butterscotch	SIE Sienna*
CIN Cinnamon*	TOF Toffee*
CLA Classic*	TRF Truffle*
EAR Earthy	VEN Venetian*
ESP Espresso	

- ④ See a selection of graded in fabric manufacturers and patterns on pages 12-20. Contact Customer Service for additional fabric options.

Specifications

- Frame: Solid Birch plywood
- Grand scale leg is 4" tall.
- Mortise and tenon construction with corner blocks, glue and screws.
- Anodized aluminum extruded leg.
- Seat has synthetic sheet webbing with cross strip webs, 3" polyurethane foam with Dacron® wrap.
- Back has synthetic sheet webbing, 2" polyurethane foam with Dacron® wrap.
- Arms have 1/4" polyurethane foam.
- Table tops are 7/8" thick and wood caps are 3/4" thick maple veneer.
- Linking bracket, see page 325.
- Standard with nylon glides.

When ordering Quickship products, place a "Q" in front of model number.
Example: QGT4901D



GRAND LINKING TABLES, LEG MOUNTED

Description	D	W	H	CTN WT	CU FT	Model	List Price
20" Linking End Table	28 ¼	20	17	27	4	HN53E2GL	\$724



20" Linking Center Table	28 ¼	20	17	27	4	HN53C2GL	\$724
--------------------------	------	----	----	----	---	----------	-------



90° Linking Straight L Table	28 ¼	28 ¼	17	29	6	HN53CLGSL	\$724
------------------------------	------	------	----	----	---	-----------	-------



90° Linking T Table	28 ¼	28 ¼	17	29	6	HN53CTGL	\$724
---------------------	------	------	----	----	---	----------	-------



90° Linking X Table	28 ¼	28 ¼	17	29	6	HN53CXGL	\$724
---------------------	------	------	----	----	---	----------	-------

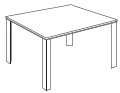

LOUNGE

Description	D	W	H	CTN WT	CU FT	① Model	List Price
22.5° Linking Table	28 ¼	19 ⅝	17	20	4	HN53C22GL	\$724



· overall width range is 9 - 19 ⅝

30° Linking Table	28 ¼	23	17	21	4	HN53C30GL	\$724
-------------------	------	----	----	----	---	-----------	-------



· overall width range is 9 - 23

45° Linking Table	28 ¼	29 ⅝	17	25	6	HN53C45GL	\$724
-------------------	------	------	----	----	---	-----------	-------

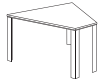

· overall width range is 9 - 29 ⅝

Linking Bracket						HN53BRKT	\$98
-----------------	--	--	--	--	--	----------	------



· set of 2 for single linking of Chair to Table or Chair to Chair application



Linking Bracket Application



Chair to Table Linked



Chair to Chair Linked

To Order, Specify:

- ① Model Number
- ② Wood Species - Maple (M)
- ③ Wood Finish
- ④ Optional Veneer Wrapped Legs (V) - add \$216 list
- ⑥ Optional Coordinating Wood Grain Laminate
Surfaces - no upcharge. Finishes with an asterisk have a coordinating laminate available.
- ⑧ Optional Felt Glide Covers - no upcharge

③ Wood Finish Options:

ALE Ale*	FLX Flax
AUB Auburn*	LGC Legacy*
AUT Autumn*	MCH Mocha*
BRL Barley*	NTO Night Owl*
BBN Bourbon*	PRL Praline*
BRG Brighton*	SAF Saffron*
BUT Butterscotch	SIE Sienna*
CIN Cinnamon*	TOF Toffee*
CLA Classic*	TRF Truffle*
EAR Earthy	VEN Venetian*
ESP Espresso	

- ④ See a selection of graded in fabric manufacturers and patterns on pages 12-20. Contact Customer Service for additional fabric options.

Specifications

- Table tops - Maple veneer.
- Table tops are 7/8" thick.
- Anodized aluminum extruded leg.
- Linking bracket, see above.
- Standard with nylon glides.

Hudson Lounge Order Check List:



Specify:

- 1. Model Number
- 2. Wood Species - Maple (M)
- 3. Wood Finish
- 4. Fabric Selection - vendor, pattern and color
- 5. Optional Rubber Cushion Nylon Glides - no upcharge

Example:

HD9901 | M | AUB | MOMENTUM | VOX | MYSTIC
 (model #) | (wood species) | (finish) | (fabric vendor) | (pattern name) | (pattern color)

1. Model Number

2. Wood Species - Maple (M)

3. Wood Finish Options: ▲

ALE Ale	FLX Flax
AUB Auburn	CGR Graphite Coordinate
AUT Autumn	CHL High Line Coordinate
BRL Barley	CKC Khaki Coordinate
CBE Blonde Echo Coordinate	LGC Legacy
BBN Bourbon	MCH Mocha
CBZ Brazilwood Coordinate	NTO Night Owl
BRG Brighton	PRL Praline
BUT Butterscotch	SAF Saffron
CIN Cinnamon	SIE Sienna
CLA Classic	CST Studio Teak Coordinate
CCF Coffee Coordinate	TOF Toffee
CCR Cremello Coordinate	TRF Truffle
EAR Earthy	VEN Venetian
ESP Espresso	CWH Walnut Heights Coordinate

4. Fabric Selection - Please supply the following:

- Fabric vendor
- Pattern name
- Pattern color

When specifying contrasting upholstery, indicate clearly which upholstery is to be applied to the seat, back and arms. Use higher grade pricing.

- Indicate direction of fabric - Railroaded or Up the Roll
- Please provide illustration, if available

All COM orders must include the following:

- Vendor's name, pattern name and color
- Sample of the fabric attached to order
- Model numbers of items for fabric application
- Special application instructions (e.g., all stripes will be applied front to back unless specified otherwise)
- Customer and purchase order number

Ship prepaid COM material to:
 JSI
 Attn: COM Dept
 932 Mill Street
 Jasper, IN 47546

Application of fabric:
 Railroaded Up the Roll

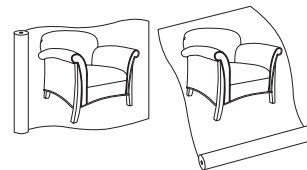

All COM orders will ship at standard lead time from receipt of COM except for orders requiring special custom matched finishes.

5. Optional Rubber Cushion Nylon Glides - no upcharge

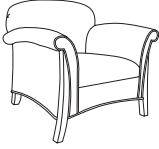
Description	Model	Specifications			List Price Per Grade	
Single Seat 	HD9901	Dimensions	D	W	H	COM \$1,693
		Overall	32	32	32	A \$1,746
		Seat	21 1/2	19 1/2	18	B \$1,851
		Arm			25	COL/C \$2,032
		Upholstery	Shipping			D \$2,267
		COM Ydg	6	Ctn Wt	64	E \$2,502
		COL Sq Ft	138	Cu Ft	27	F \$2,749
						G \$3,101
						H \$3,476
						I \$4,063
				J \$4,766		
				L1 \$3,641		
				L2 \$4,133		

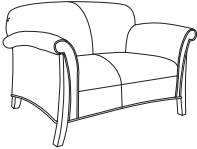
Two Seat 	HD9902	Dimensions	D	W	H	COM \$2,484
		Overall	32	52	32	A \$2,570
		Seat	21 1/2	39 1/2	18	B \$2,739
		Arm			25	COL/C \$3,035
		Upholstery	Shipping			D \$3,416
		COM Ydg	9 3/4	Ctn Wt	90	E \$3,797
		COL Sq Ft	225	Cu Ft	45	F \$4,199
						G \$4,772
						H \$5,382
						I \$6,334
				J \$7,478		
				L1 \$5,648		
				L2 \$6,449		

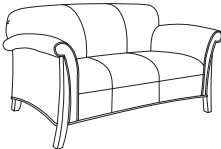
Three Seat 	HD9903	Dimensions	D	W	H	COM \$3,049
		Overall	32	72	32	A \$3,145
		Seat	21 1/2	59 1/2	18	B \$3,336
		Arm			25	COL/C \$3,671
		Upholstery	Shipping			D \$4,101
		COM Ydg	11	Ctn Wt	113	E \$4,531
		COL Sq Ft	253	Cu Ft	63	F \$4,985
						G \$5,630
						H \$6,317
						I \$7,392
				J \$8,683		
				L1 \$6,619		
				L2 \$7,522		

To Order, Specify:

- 1 Model Number
- 2 Wood Species - Maple (M)
- 3 Wood Finish
- 4 Fabric Selection - vendor, pattern and color
- 5 Optional Rubber Cushion Nylon Glides - no upcharge

3 Wood Finish Options: ▲

ALE Ale	FLX Flax
AUB Auburn	CGR Graphite Coordinate
AUT Autumn	CHL High Line Coordinate
BRL Barley	CKC Khaki Coordinate
CBE Blonde Echo Coordinate	LGC Legacy
BBN Bourbon	MCH Mocha
CBZ Brazilwood Coordinate	NTO Night Owl
BRG Brighton	PRL Praline
BUT Butterscotch	SAF Saffron
CIN Cinnamon	SIE Sienna
CLA Classic	CST Studio Teak Coordinate
CCF Coffee Coordinate	TOF Toffee
CCR Cremello Coordinate	TRF Truffle
EAR Earthy	VEN Venetian
ESP Espresso	CWH Walnut Heights Coordinate

- 4 See a selection of graded in fabric manufacturers and patterns on pages 12-20. Contact Customer Service for additional fabric options.

Specifications

- Wood species - Maple.
- 7/8" thick furniture-grade plywood with locking tenons, glue and screws.
- Seats and backs have synthetic sheet webbing suspension.
- Seats have 5 1/2" and backs 3" high density polyurethane foam with Dacron® wrap.
- Arms have 1/2" polyurethane foam.
- Standard with rubber cushion metal glides.

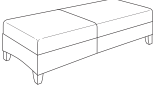
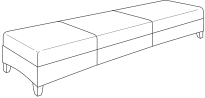
Description	① Model	Specifications				List Price Per Grade	
	HD9991	Dimensions		D	W	H	COM \$1,075
		Overall	25 ½	20 ½	15	A \$1,092	
		Upholstery		Shipping		B \$1,127	
		COM Ydg	2	Ctn Wt	41	COL/C \$1,188	
		COL Sq Ft	40	Cu Ft	30	D \$1,267	
						E \$1,344	
				F \$1,427			
				G \$1,544			
				H \$1,669			
				I \$1,865			
				J \$2,099			
				L1 \$1,630			
				L2 \$1,771			
	HD9992	Dimensions		D	W	H	COM \$1,414
		Overall	25 ½	40 ½	15	A \$1,438	
		Upholstery		Shipping		B \$1,486	
		COM Ydg	2 ¾	Ctn Wt	76	COL/C \$1,570	
		COL Sq Ft	55	Cu Ft	46	D \$1,677	
						E \$1,784	
				F \$1,898			
				G \$2,060			
				H \$2,232			
				I \$2,501			
				J \$2,823			
				L1 \$2,178			
				L2 \$2,371			
	HD9993	Dimensions		D	W	H	COM \$1,696
		Overall	25 ½	60 ½	15	A \$1,738	
		Upholstery		Shipping		B \$1,821	
		COM Ydg	4 ¾	Ctn Wt	116	COL/C \$1,965	
		COL Sq Ft	95	Cu Ft	62	D \$2,151	
						E \$2,337	
				F \$2,532			
				G \$2,811			
				H \$3,108			
				I \$3,573			
				J \$4,129			
				L1 \$3,015			
				L2 \$3,349			

LOUNGE

To Order, Specify:

- ① Model Number
- ② Wood Species - Maple (M)
- ③ Wood Finish
- ④ Fabric Selection - vendor, pattern and color
- ⑤ Optional Rubber Cushion Nylon Glides - no upcharge

③ Wood Finish Options: ▲

ALE Ale	FLX Flax
AUB Auburn	CGR Graphite Coordinate
AUT Autumn	CHL High Line Coordinate
BRL Barley	CKK Khaki Coordinate
CBE Blonde Echo Coordinate	LGC Legacy
BBN Bourbon	MCH Mocha
CBZ Brazilwood Coordinate	NTO Night Owl
BRG Brighton	PRL Praline
BUT Butterscotch	SAF Saffron
CIN Cinnamon	SIE Sienna
CLA Classic	CST Studio Teak Coordinate
CCF Coffee Coordinate	TOF Toffee
CCR Cremello Coordinate	TRF Truffle
EAR Earthy	VEN Venetian
ESP Espresso	CWH Walnut Heights Coordinate

Specifications

- Wood species - Maple.
- 7/8" thick furniture-grade plywood with locking tenons, glue and screws.
- Seats and backs have synthetic sheet webbing suspension.
- Seats have synthetic sheet webbing suspensions and 5 1/2" high density polyurethane foam with Dacron® wrap.
- Standard with rubber cushion metal glides.

- ④ See a selection of graded in fabric manufacturers and patterns on pages 12-20. Contact Customer Service for additional fabric options.

Luci Order Check List:



Specify:

- 1. Model Number
- 2. Wood Species - Ash (A) (chairs) or Maple (M) (tables)
- 3. Wood Finish/Color
- 4. Fabric Selection - vendor, pattern and color

Example:

WK821CP | **A** | **AUB** | **MOMENTUM** | **VOX** | **MYSTIC**
 (model #) | (wood species) | (finish) | (fabric vendor) | (pattern name) | (pattern color)

1. Model Number

2. Wood Species - Ash (A) (chairs) or Maple (M) (tables)

3. Wood Finish/Color Options:

ALE Ale	FLX Flax
AUB Auburn	LGC Legacy
AUT Autumn	MCH Mocha
BRL Barley	NTO Night Owl
BBN Bourbon	PRL Praline
BRG Brighton	SAF Saffron
BUT Butterscotch	SIE Sienna
CIN Cinnamon	TOF Toffee
CLA Classic	TRF Truffle
EAR Earthy	VEN Venetian
ESP Espresso	
Color - Add \$31 list per item	
BKD Backdrop	GRV Greek Villa
BFX Black Fox	GLF Gulf Stream
BWH Bright White	HTB Heartthrob
CGP Cargo Pants	NET Network Gray
CHT Chatroom	NWH Nonchalant White
DSY Daisy	PAR Paradise
DRG Daring	QXP Quixotic Plum
DYN Dynamo	RBZ Relic Bronze
ENG Enigma	SND Sandbank
FRR French Roast	STM Storm
GBY Georgian Bay	TRC Tricorn Black

4. Fabric Selection - Please supply the following:

- Fabric vendor
- Pattern name
- Pattern color

When specifying contrasting upholstery, indicate clearly which upholstery is to be applied to the seat and back. Use higher grade pricing.

- Indicate direction of fabric - Railroaded or Up the Roll
- Please provide illustration, if available

All COM orders must include the following:

- Vendor's name, pattern name and color
- Sample of the fabric attached to order
- Model numbers of items for fabric application
- Special application instructions (e.g., all stripes will be applied front to back unless specified otherwise)
- Customer and purchase order number

Ship prepaid COM material to:
 JSI
 Attn: COM Dept
 932 Mill Street
 Jasper, IN 47546

Application of fabric:
 Railroaded Up the Roll

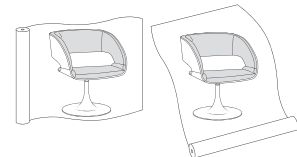



All COM orders will ship at standard lead time from receipt of COM except for orders requiring special custom matched finishes.

Description	① Model	Specifications				List Price Per Grade	
Guest Chair  LU721DT trumpet base	LU721DT · trumpet base · polished aluminum base · five ½" round plastic glides · self-centering seat · arm height range is 25 - 31 ½	Dimensions		D	W	H	COM \$1,977
		Overall	22 ½	24 ¾	32 ½	A \$1,992	
		Seat	18 ½	19	19	B \$2,023	
		Arm			31 ½	COL/C \$2,076	
		Upholstery		Shipping		D \$2,145	
		COM Ydg	1 ¾	Ctn Wt	49	E \$2,213	
		COL Sq Ft	32	Cu Ft	16	F \$2,285	
						G \$2,387	
						H \$2,497	
						I \$2,669	
				J \$2,873			
				L1 \$2,408			
				L2 \$2,517			

Description	① Model	Specifications				List Price Per Grade	
Guest Chair  LU721DX 4-prong base	LU721DX · 4-prong base · chrome 4-prong base · four 1" x ½" black plastic glides · arm height range is 25 - 31 ½	Dimensions		D	W	H	COM \$1,710
		Overall	22 ½	24 ¾	32 ½	A \$1,726	
		Seat	18 ½	19	19	B \$1,756	
		Arm			31 ½	COL/C \$1,810	
		Upholstery		Shipping		D \$1,878	
		COM Ydg	1 ¾	Ctn Wt	42	E \$1,946	
		COL Sq Ft	32	Cu Ft	16	F \$2,019	
						G \$2,120	
						H \$2,231	
						I \$2,402	
				J \$2,607			
				L1 \$2,141			
				L2 \$2,251			

Description	D	W	H	CTN WT	CU FT	① Model	List Price
Round Table	36	36	15 5/8	37	15	LU36RT	\$677
 trumpet base	30	30	15 5/8	31	11	LU30RT	\$630
						<ul style="list-style-type: none"> polished aluminum base reverse beveled edge profile 23" base diameter 	

Round Table	36	36	15 5/8	37	15	LU36RX	\$942
 4-prong base	30	30	15 5/8	31	11	LU30RX	\$895
						<ul style="list-style-type: none"> polished aluminum base reverse beveled edge profile 23" base diameter 	

Square Table	36	36	15 5/8	41	15	LU3636ST	\$677
 trumpet base	30	30	15 5/8	34	11	LU3030ST	\$630
						<ul style="list-style-type: none"> polished aluminum base reverse beveled edge profile 23" base diameter 	

Square Table	36	36	15 5/8	41	15	LU3636SX	\$942
 4-prong base	30	30	15 5/8	34	11	LU3030SX	\$895
						<ul style="list-style-type: none"> polished aluminum base reverse beveled edge profile 23" base diameter 	

LOUNGE

To Order, Specify:

- ① Model Number
- ② Wood Species - Ash (A) (chairs), Maple (M) (tables)
- ③ Wood Finish/Color
- ④ Fabric Selection - vendor, pattern and color

③ Wood Finish Options:

ALE Ale	FLX Flax
AUB Auburn	LGC Legacy
AUT Autumn	MCH Mocha
BRL Barley	NTO Night Owl
BBN Bourbon	PRL Praline
BRG Brighton	SAF Saffron
BUT Butterscotch	SIE Sienna
CIN Cinnamon	TOF Toffee
CLA Classic	TRF Truffle
EAR Earthy	VEN Venetian
ESP Espresso	

Specifications

- Wood species - Ash (A) (chairs), Maple (M) (tables).
- Chairs have a two piece plywood shell.
- Seat and back are upholstered with 1 1/4" high density polyurethane foam.
- Chairs have a 360° swivel.
- Reverse bevel edge on table tops.
- All standard with rubber cushion nylon glides.

Color - Add \$31 list per item

BKD Backdrop	GRV Greek Villa
BFX Black Fox	GLF Gulf Stream
BWH Bright White	HTB Heartthrob
CGP Cargo Pants	NET Network Gray
CHT Chatroom	NWH Nonchalant White
DSY Daisy	PAR Paradise
DRG Daring	QXP Quixotic Plum
DYN Dynamo	RBZ Relic Bronze
ENG Enigma	SND Sandbank
FRR French Roast	STM Storm
GBY Georgian Bay	TRC Tricorn Black

Moto Lounge Order Check List:



Specify:

- 1. Model Number
- 2. Fabric Selection
 - A. Chair - vendor, pattern and color
 - B. Seat Cushion - vendor, pattern and color
 - C. Privacy Screen - vendor, pattern and color
- 3. Optional Casters; add \$84 list
- 4. Optional Wood Feet; specify finish; add \$53 list
- 5. Optional Tablet Arm; specify material, finish and add \$538 list per arm
- 6. Optional Arm Cap; specify wood species, finish and add \$242 list per arm
- 7. Optional Power Center - Flush Mount (EC22) - Black (B) or White (W)
 - Side of Seating; add \$478 list each and specify right or left
 - Side of Privacy Surround; add \$504 list each and specify right or left
 - Back of Work Shelf; add \$529 list each
- 8. Work Shelf Wood Species - Cherry (CH1), Maple (MA1) or Walnut (WA1)
- 9. Work Shelf Wood Finish
- 10. Work Shelf Laminate Color Selection
- 11. Optional Work Shelf Acrylic Screen; add \$191 list

Example:

MTL301UAR (model #)	MOMENTUM (fabric vendor)	VOX (pattern name)	MYSTIC (pattern color)	CASTERS	TABLET ARM	WA1 (tablet arm wood species)	MCH (tablet arm finish)
------------------------	-----------------------------	-----------------------	---------------------------	---------	------------	----------------------------------	----------------------------

LOUNGE

1. Model Number

- 2. Fabric Selection** - Please supply the following:
- Fabric vendor
 - Pattern name
 - Pattern color

When specifying contrasting upholstery, indicate clearly which upholstery is to be applied to the chair, seat and privacy screen. Use higher grade pricing.

- Indicate direction of fabric - Railroaded or Up the Roll
- Please provide illustration, if available

All COM orders must include the following:

- Vendor's name, pattern name and color
- Sample of the fabric attached to the order
- Model numbers of items for fabric application
- Special application instructions (e.g., all stripes will be applied front to back unless specified otherwise)
- Customer and purchase order number

Ship prepaid COM material to:
 JSI
 Attn: COM Dept
 932 Mill Street
 Jasper, IN 47546

Application of fabric:
 Railroaded Up the Roll

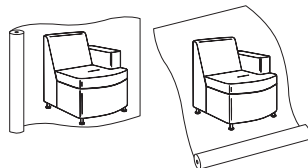

All COM orders will ship at standard lead time from receipt of COM except for orders requiring special custom matched finishes.

3. Casters - Add \$84 list

4. Wood Feet - Solid maple wood feet with leveling glide. Add \$53 list and specify finish.



5. Tablet Arm -

- Rotating 10" x 14" oval surface or 10" x 16" rectangular surface ▲
- 300 lb maximum static weight rating
- Available on Inline or Convex units with arm
- Available in veneer or laminate
- Exposed plywood edge on veneer tablet is finished with veneer color. Laminate tablet will have a clear finish on the exposed plywood edge. ▲
- Add \$538 list per arm and specify shape, material and finish

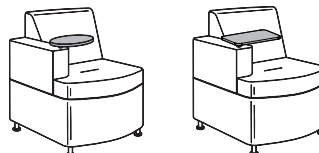

▲ Revised 7/15/16

Tablet Arm Wood Finish Selection:

Cherry (CH1)		Maple (MA1)	
AUT	Autumn	ALE	Ale
BRL	Barley	BUT	Butterscotch
BBN	Bourbon	CIN	Cinnamon
BRG	Brighton	FLX	Flax
CLA	Classic	VEN	Venetian
EAR	Earthy		
LGC	Legacy		
PRL	Praline		
SAF	Saffron		

Walnut (WA1)

AUB	Auburn
ESP	Espresso
MCH	Mocha
NTO	Night Owl
SIE	Sienna
TOF	Toffee
TRF	Truffle

Tablet Arm Laminate Selection:

ALB	Alabaster	GRH	Graphite
AUT	Autumn	HGL	High Line
BLO	Blonde Echo	SLG	Slate Grey
BBN	Bourbon	SHD	Shadow
BZW [▲]	Brazilwood	SLG	Slate Grey
BBL	Bridal Blanco	STU	Studio Teak
BRG	Brighton	TAU	Taupe
DWH	Designer White	VIN	Vintage
DOV	Dove Grey	WLH	Walnut Heights

6. Arm Cap -

- Available in Cherry (CH1), Maple (MA1) or Walnut (WA1)
- Add \$242 list per arm and specify wood species and finish.



7. Power Center - Flush Mount (EC22) - Specify Black (B) or White (W).

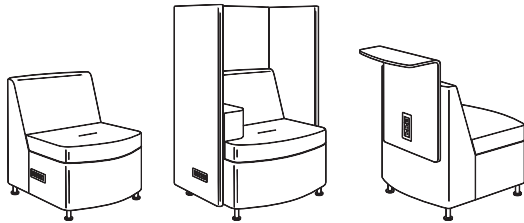

Power Center option can be specified on the sides of seating units and privacy surrounds, or in the back of work shelves. It features two waterproof 110 outlets and one dual USB port. Power is connected to the building supply with a 10' long standard three prong cord. A hook and loop chair bottom allows access to power cords in the base of the chair.

Power Center

- Side of Seating; add \$478 list each and specify right or left
- Side of Privacy Surround; add \$504 list each and specify right or left.
- Back of Work Shelf; add \$529 list each

8. Work Shelf Wood Species - Cherry (CH1), Maple (MA1) or Walnut (WA1)

9. Work Shelf Wood Finish Options:

Cherry (CH1)		Maple (MA1)	
AUT	Autumn	ALE	Ale
BRL	Barley	BUT	Butterscotch
BBN	Bourbon	CIN	Cinnamon
BRG	Brighton	FLX	Flax
CLA	Classic	VEN	Venetian
EAR	Earthy		
LGC	Legacy		
PRL	Praline		
SAF	Saffron		

Walnut (WA1)

AUB	Auburn
ESP	Espresso
MCH	Mocha
NTO	Night Owl
SIE	Sienna
TOF	Toffee
TRF	Truffle

10. Work Shelf Laminate Color Selection

DWH	Designer White
SHD	Shadow
SLG	Slate Grey

11. Work Shelf Acrylic Screen

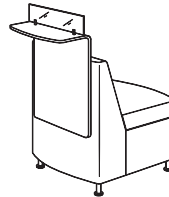

Units with a work shelf can be specified with an acrylic screen. The frosted screen is on brushed aluminum standoffs and is 4 3/8"▲ tall. Add \$191 list.

Moto Casegoods Order Check List:



Specify:

- 1. Model Number
- 2. Wood Species - Cherry (CH1), Maple (MA1) or Walnut (WA1)
- 3. Wood Finish
- 4. Laminate Selection
- 5. Conical Base Finish
- 6. Optional Wood Feet; specify finish; add \$53 list
- 7. Optional Power Unit
 - Linking Drum Table - Node - Black (B) or White (w); see page 374
 - Conical Work Table - Moire - Black (B) or White (W); see page 374
 - Media Table - Ellora; see page 374
- 8. Optional DropShare Power Unit; see page 374
- 9. Optional Markerboard Back Panel; for 24" unit add \$189 list, for 48" unit add \$368 list
- 10. Deduct TV Bracket; subtract \$180 list
- 11. Optional Door Locks; add \$105 list

Examples:

MT4878-30MACW (model #)	WA1 (wood species)	MCH (wood finish)	DROP12 Power Unit
MTF54ROUN (model #)	STU (top laminate)	BWH (base finish)	Moire - EC23 Power Unit

1. Model Number

2. Wood Species - Cherry (CH1), Maple (MA1) or Walnut (WA1)

3. Wood Finish Selection:

Cherry (CH1)

- AUT Autumn*
- BRL Barley*
- BBN Bourbon*
- BRG Brighton*
- CLA Classic*
- EAR Earthy
- LGC Legacy*
- PRL Praline*
- SAF Saffron*

Maple (MA1)

- ALE Ale*
- BUT Butterscotch
- CIN Cinnamon*
- FLX Flax
- VEN Venetian*

Walnut (WA1)

- AUB Auburn*
- ESP Espresso
- MCH Mocha*
- NTO Night Owl*
- SIE Sienna*
- TOF Toffee*
- TRF Truffle*

4. Laminate Selection:

- | | |
|--------------------|--------------------|
| ALB Alabaster | GRH Graphite |
| AUT Autumn | HGL High Line |
| BLO Blonde Echo | SHD Shadow |
| BBN Bourbon | SHE Shea |
| BZW Brazilwood | SLG Slate Grey |
| BBL Bridal Blanco | STU Studio Teak |
| BRG Brighton | TAU Taupe |
| DWH Designer White | VIN Vintage |
| DOV Dove Grey | WLH Walnut Heights |

5. Paint Finish: Polystyrene table base available in wood finishes, laminate coordinate or paint colors.

- | | |
|------------------|----------------------|
| BKD Backdrop | GRV Greek Villa |
| BFX Black Fox | NET Network Gray |
| BWH Bright White | NWH Nonchalant White |
| CGP Cargo Pants | STM Storm |
| CHT Chatroom | TRC Tricorn Black |
| FRR French Roast | |

6. Wood Feet - Solid maple wood feet with leveling glide.
Add \$53 list and specify finish.



▲ Revised 11/1/15

- 7. Power Unit** - Power Units can be specified in Linking Drum Tables, Conical Work Tables, Media Tables and Media Credenzas. Specify the table to be fitted for power and order the power unit separately.

Linking Drum Table - Node - EC24 - One 110 outlet and a dual USB port with 72" power cord - Black (B) or White (W); see page 374.



Conical Work Table - Moire - EC23 - Three 110 outlets and a dual USB port with 72" power cord - Black (B) or White (W); see page 374.



Media Table - Ellora - EC25 - Two 110 outlets, a dual powered USB port, and 1 data receptacle with wire pass-through and 72" power cord - anodized aluminum; see page 374.

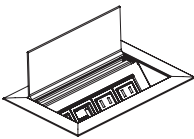

8. DropShare Power Unit

Specify the table to be fitted for Drop12 or Drop14 and order the unit separately.

Drop12 - Two 110 outlets and Two DropShare cords; see page 374.

Drop14 - Two 110 outlets and Four DropShare cords; see page 374.

-
- 9. Markerboard Back Panel** - Dry-Erase markerboard laminate can be specified on the back panels of Media Tables, Media Credenzas and Bookcase units. When specified, the inside back of the cabinet will also be markerboard; for 24" unit add \$189 list, for 48" unit add \$368 list.

10. Deduct TV Bracket; subtract \$180 list

11. Optional Door Locks; add \$105 list

-
- 12. Optional Coordinating Wood Grain Laminate Table Top** - no upcharge; Drum Tables, Media Tables and Media Credenzas only. Finishes with an asterisk (*) have a coordinating laminate available. ▲

Foot Options

Moto offers two foot styles or casters. The metal foot is standard on seating, casegoods and linking drum tables. An optional wood foot is available at an additional upcharge on lounge, linking drum tables and casegoods. Casters are available on seating with an additional upcharge. Casters are non-locking.

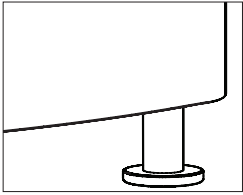

Metal Foot - Standard
Fabricated Metal
Arctic Silver Powder Coat
Adjustable Glide

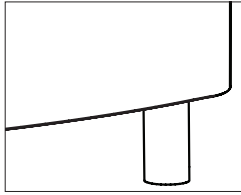

Wood Foot - Optional
Maple Species
Adjustable Glide

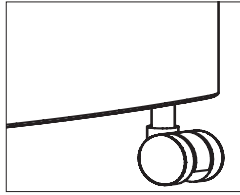

Casters - Optional
Black Dual Wheel
Four Caster Set
Non-locking

Adjustable Foot - Leveling

The standard foot has integrated leveling, which is beneficial when connecting units together in long runs on uneven floors. As the glide is turned to adjust leveling an attached shroud drops to hide the threads of the bolt.

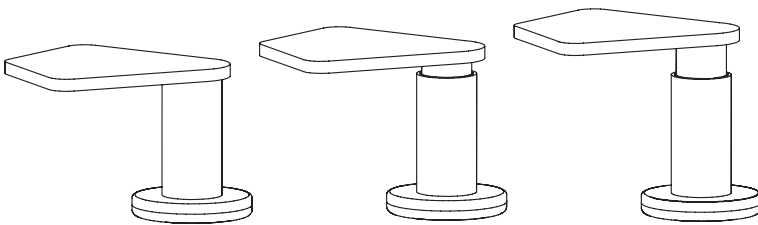

The maximum recommended adjustment is no more than 1 3/4".

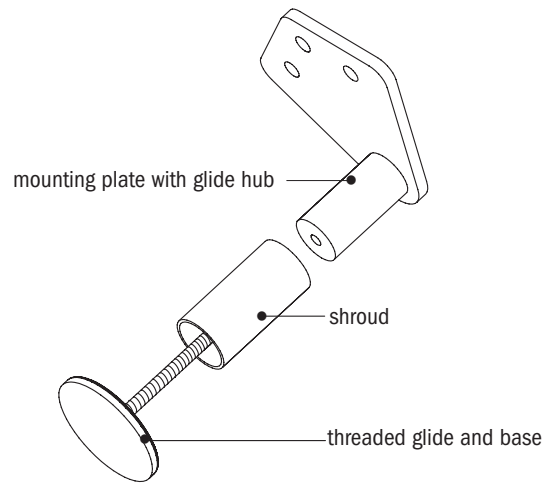

LOUNGE

Upholstery Application

The fabric will be applied "up the roll" unless railroad is specified.

The Concave Corner unit will have a diagonal seam on all fabric applications. Shown below is an example of a directional textile on the Corner Club unit.

Additional seaming may be needed pending fabric width and fabric repeat match, contact Customer Service with questions. JSI will strive to match fabric patterns but cannot guarantee a match on repeats greater than 15" on the Moto product line.

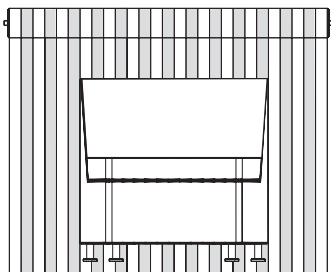

up the roll

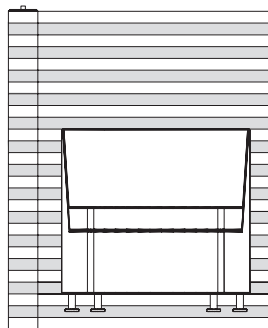

railroaded

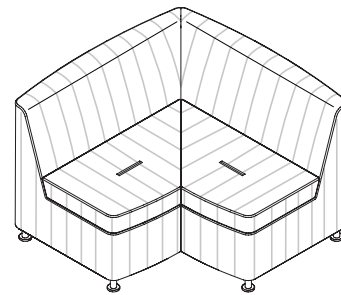

90° Concave Corner

Contrasting Upholstery Specification

This form should accompany orders when specifying contrasting or complementary upholstery.

examples

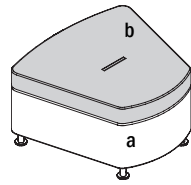

Benches - Inline - Concave- Convex

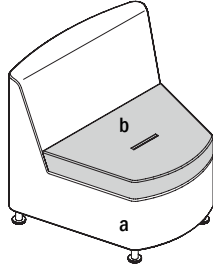

Club Chair - Inline - Concave - Convex

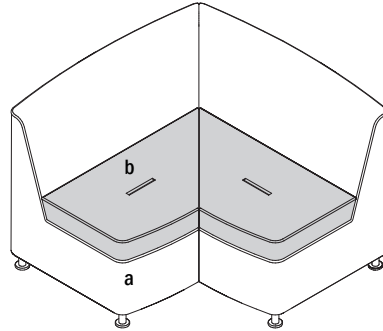

Corner - Concave - Convex

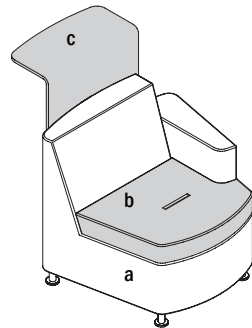

Club Chair with Shelf - Inline - Concave

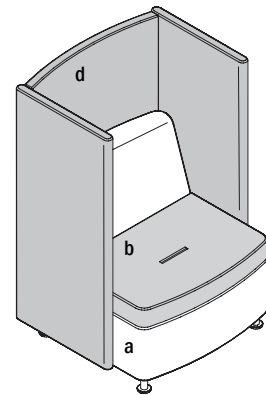

Club Chair with Privacy - Screen - Surround

fill out for each model ordered

Code Explanation

- a = upholstered chassis, back and arm(s) - fabric choice required
- b = seat cushion (light gray) - fabric choice required
- c = work shelf either veneer or laminate
 - veneer - Cherry, Maple or Walnut - finish choice required
 - laminate - Designer White, Shadow or Slate Grey
- d= Privacy Screen/Surround - fabric choice required

Item 1

Model Number: _____

chassis, back and arms (a): _____

seat (b): _____

work shelf (c): _____

screen/surround (d): _____

Item 2

Model Number: _____

chassis, back and arms (a): _____

seat (b): _____

work shelf (c): _____

screen/surround (d): _____

Item 3

Model Number: _____

chassis, back and arms (a): _____

seat (b): _____

work shelf (c): _____

screen/surround (d): _____

Item 4

Model Number: _____

chassis, back and arms (a): _____

seat (b): _____

work shelf (c): _____

screen/surround (d): _____

Item 5

Model Number: _____

chassis, back and arms (a): _____

seat (b): _____

work shelf (c): _____

screen/surround (d): _____

photo copy or scan

LOUNGE

Installation of Privacy Screen and Work Shelf

Simple field installation is required on club chairs when ordering units with privacy screens and work shelves. Instructions are included. Access to the back of the chair is through the chair bottom. Attaching knobs are included, no tools are required.

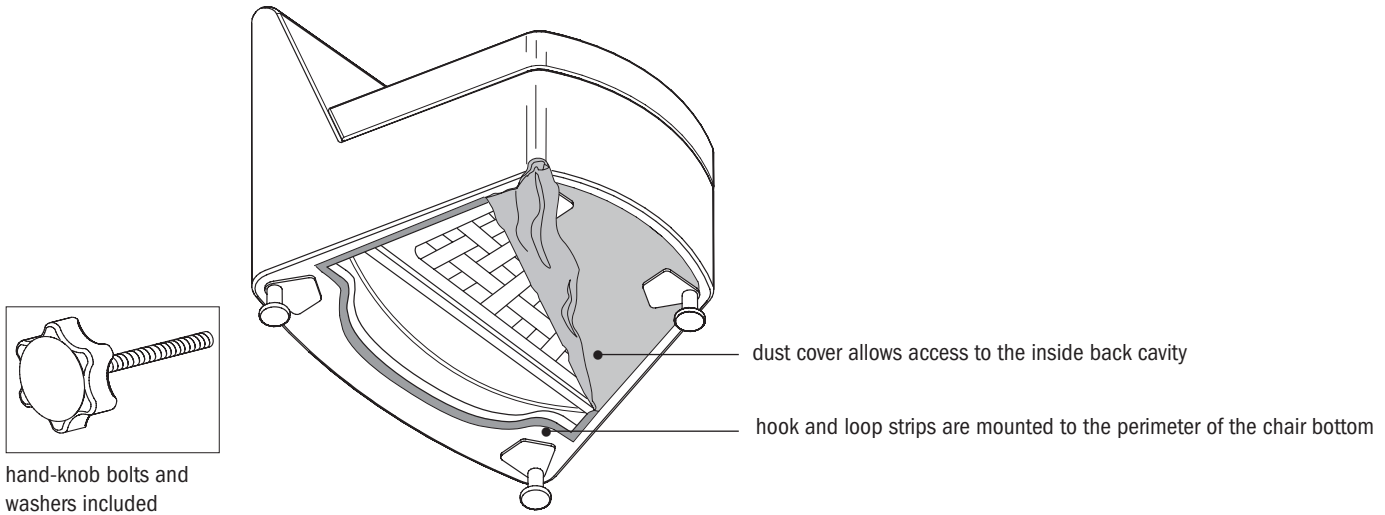

Moto Options for Lounge Seating

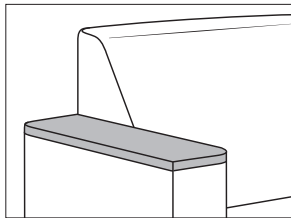

Arm Cap
 specify wood species and finish
 Cherry (CH1)
 Maple (MA1)
 Walnut (WA1)
 add \$242 list per arm

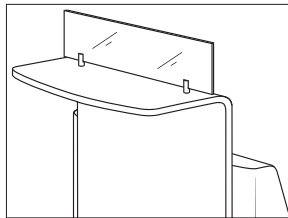

Work Shelf Acrylic Screen
 frosted acrylic screens
 4 3/8" tall - from work shelf surface
 brushed aluminum standoffs
 add \$191 list.

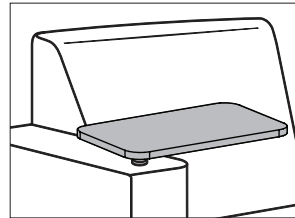

Tablet Arm ▲
 rotating 10" x 16" rectangular surface
 or 10" x 14" oval surface
 300 lb max. static weight rating
 for inline or convex units with arms
 specify surface finish and species
 veneer
 Cherry (CH1)
 Maple (MA1)
 Walnut (WA1)
 (stained plywood edge)
 laminate
 (clear coat plywood edge)
 add \$538 list per arm

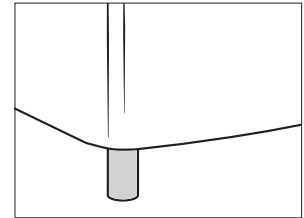

Wood Foot
 maple wood species
 adjustable glide - up to 3/4"
 specify finish
 add \$53 list per chair

LOUNGE

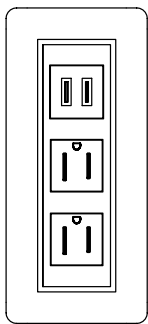

EC22 (3 installed locations)
 Flush Mount Power Center
 two 110 devices and
 one USB 2-Port Simplex for charging

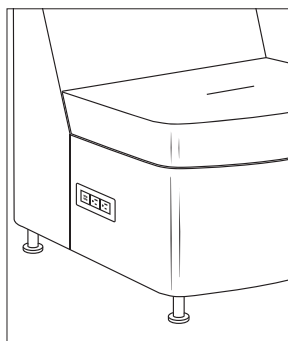

side of seating
 specify right or left
 add \$478 list for each EC22

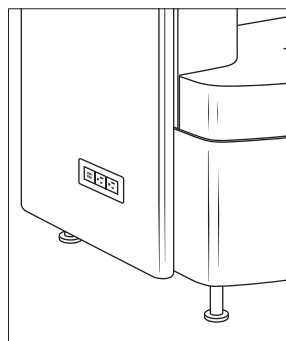

side of privacy surround
 specify right or left
 add \$504 list for each EC22

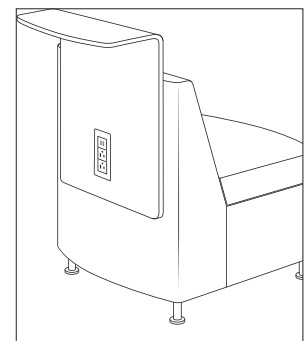

back of work shelf
 add \$529 list

Additional Product Information

Half Round Dimensions

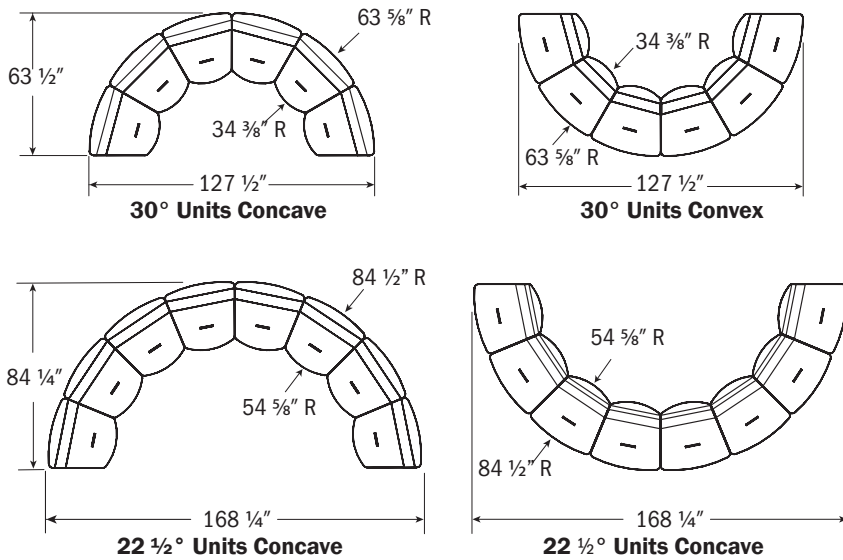

Modular Lounge and Linking Drum Tables

An Alligator Clip assembly is installed to connect lounge and linking drum tables. The clip is installed on the left bottom side rail and the hook is installed on the right bottom side rail. The bottom chair rails are bored to accept either the clip or hook for field re-configurations.

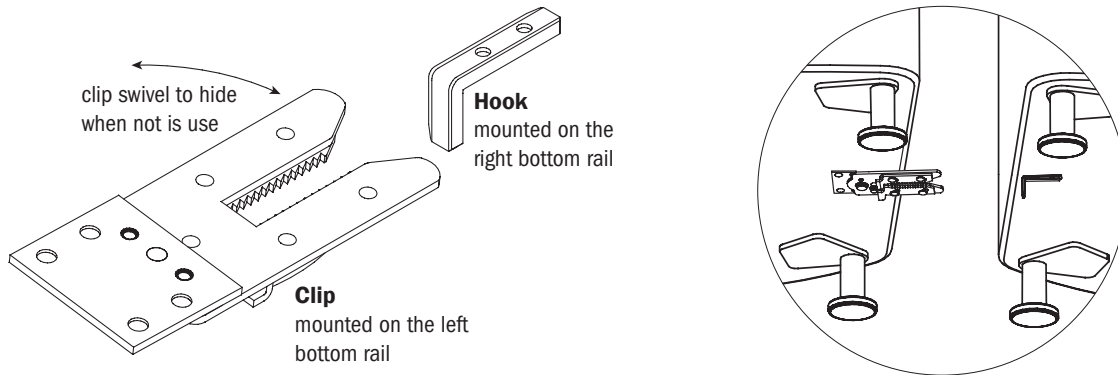

Note: Linking Table Tops are permanent bolt thru attachment and do not use the above clip.

Lounge Seating - Seam Detail

Seats have a seam detail in the center of the seat. This seam detail is standard and will help keep the tailored look of Moto. Please note that fabrics and leathers are all different (fiber content, yarn elasticity and yarn weight) which can affect the tailoring of the Moto Lounge. The aesthetic seam helps with variations in the upholstery cover. Contact Customer Service with fabric and leather information if a concern exists with a certain upholstery cover.

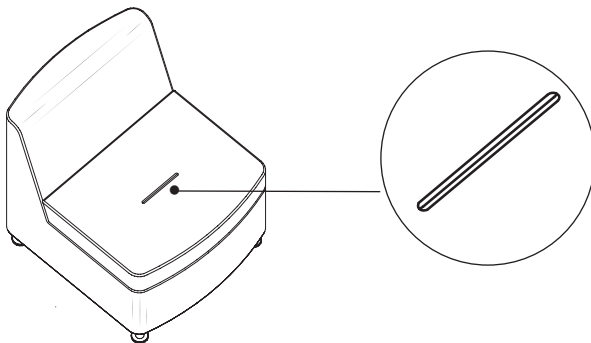

LOUNGE

Casegood & Table Edge Details

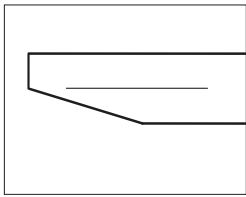

Bevel Edge

used on pull-up tables

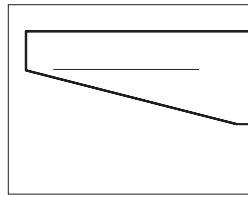

Bevel Edge

used on work tables

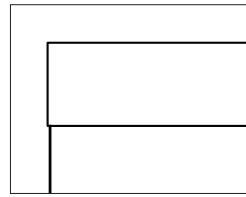

Straight Edge

used on linking tables

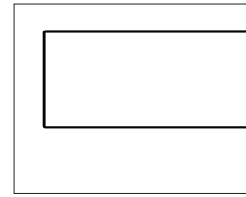

Straight Edge

used on media table surfaces



3/4" thick
available in
cherry veneer
maple veneer
walnut veneer
paint
standard laminate - HPL
(bevel underside MDF)



1 3/16" thick
available in
cherry veneer
maple veneer
walnut veneer
paint
standard laminate - HPL
(bevel underside MDF)

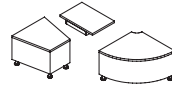

1" thick
available in
cherry veneer
maple veneer
walnut veneer
standard laminate - HPL

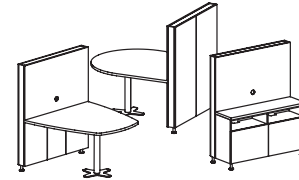

1 3/16" thick
available in
cherry veneer
maple veneer
walnut veneer
standard laminate - HPL

Linking Tables - Grain Direction

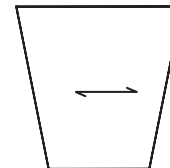
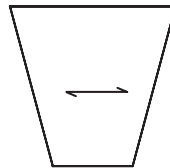
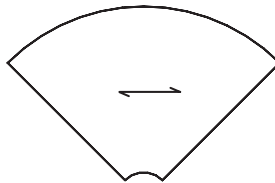
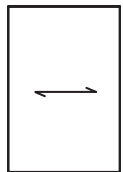

LOUNGE

Linking Drum Tables - Power Location

The EC24 or EC23 are available on linking drum tables. Wire management moves through the bottom cavity. The location shown below is for all table shapes.

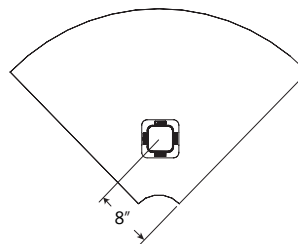
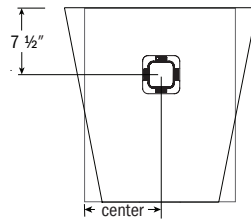
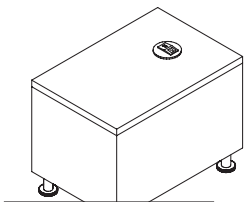

EC24

Work Tables - Power and Wire Management

The optional EC23 or EC24 is recommended for the work tables. When electrical units are used on the work tables with a conical base, the base allows wires to run through to a floor outlet. The unrestricted opening at the bottom of the base allows the base to be placed over the floor electrical monument.

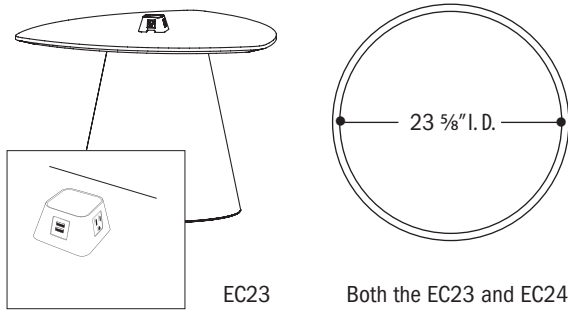

EC23

Both the EC23 and EC24 are centered on the top under the base.

Conical Table Base - Material and Grain Direction

The conical base on the pull-up and work tables is polystyrene material with a wood grain texture. This base is available in wood finishes and paint colors. Color Coordinate Finishes are intended to coordinate with select laminates. Adjustable leveling glides are included.

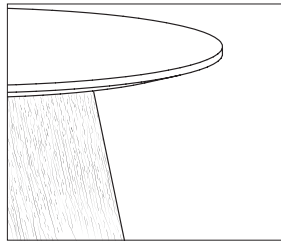

Media Tables and Media Credenzas - Wire Management and Power/Data

Easy access to wiring is provided in the Moto Media products. Well placed grommets, doors, and allowance inside the cabinets makes it easy to outfit these units quickly. The recommended EC25 brings power and data access to the top.

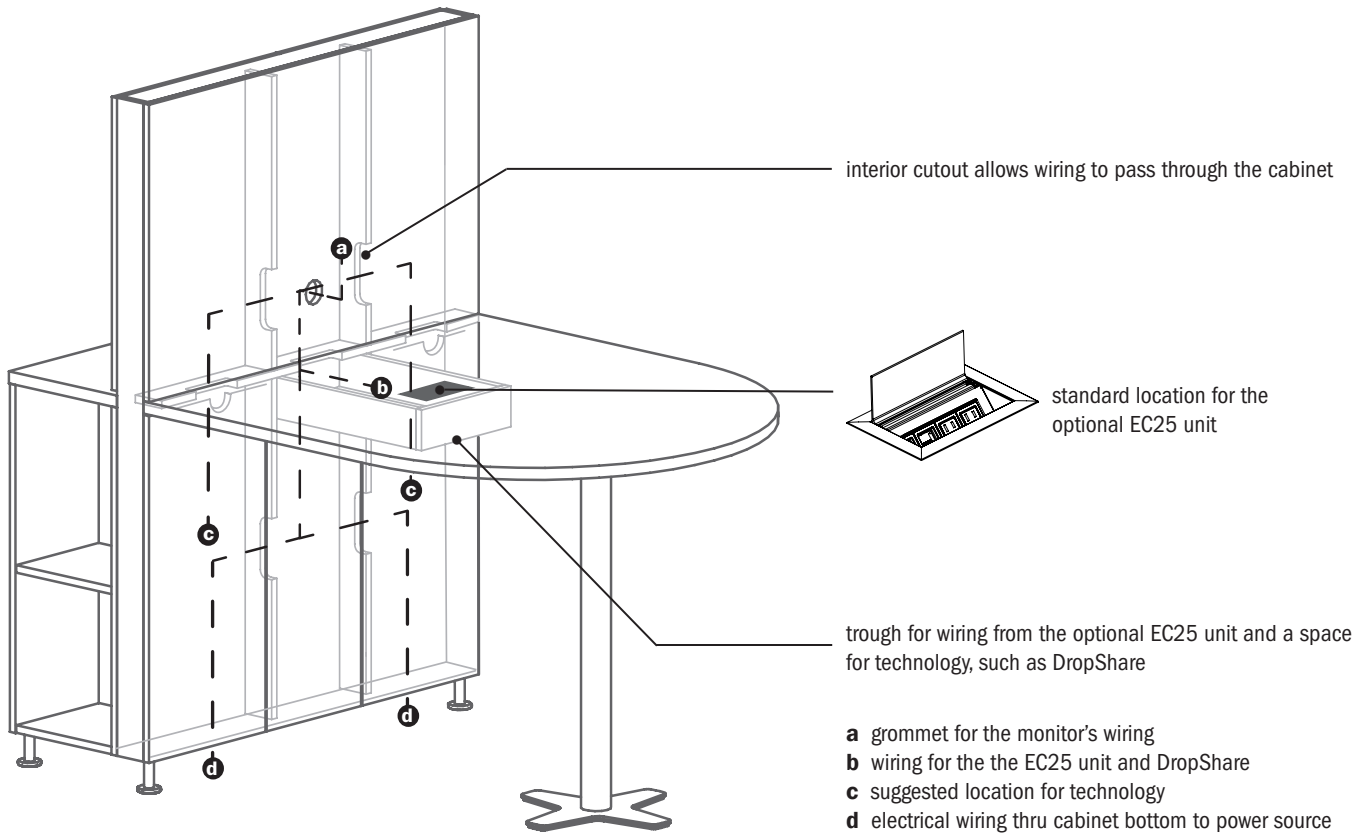

LOUNGE

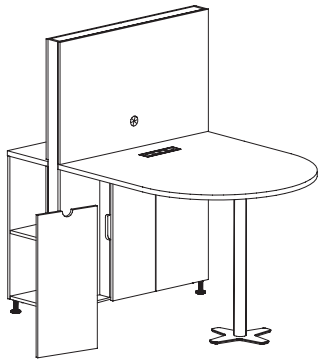

removable panels

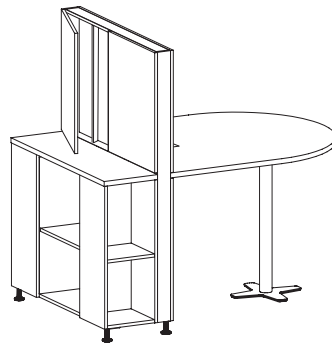

hinged doors

Media Tables - Power Location

The EC25 is available on media tables. The location shown below is for all table wedge shape tops, location for EC25 on bullet shapes are similar.

EC25 Power Unit Location Examples

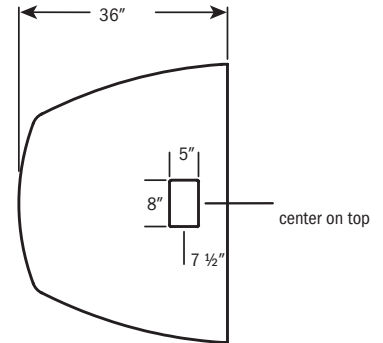
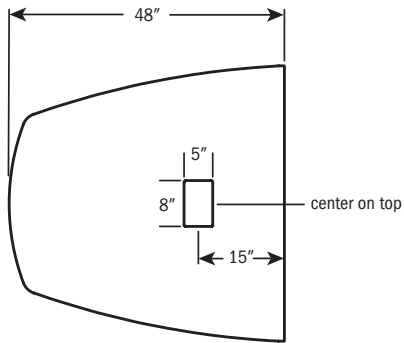
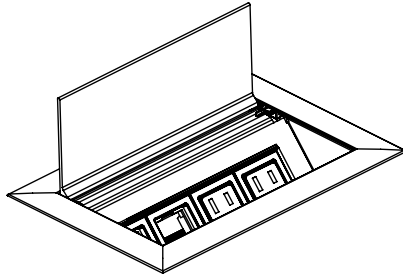

Media Tables - Leveling the Post Column

Leveling is made easy by turning the column.

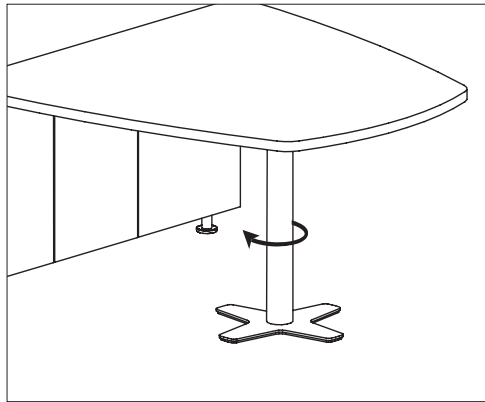

Markerboard Back Panel Options

Markerboard back panels can be specified for the back panels on Media Tables, Media Credenzas and Bookcases.

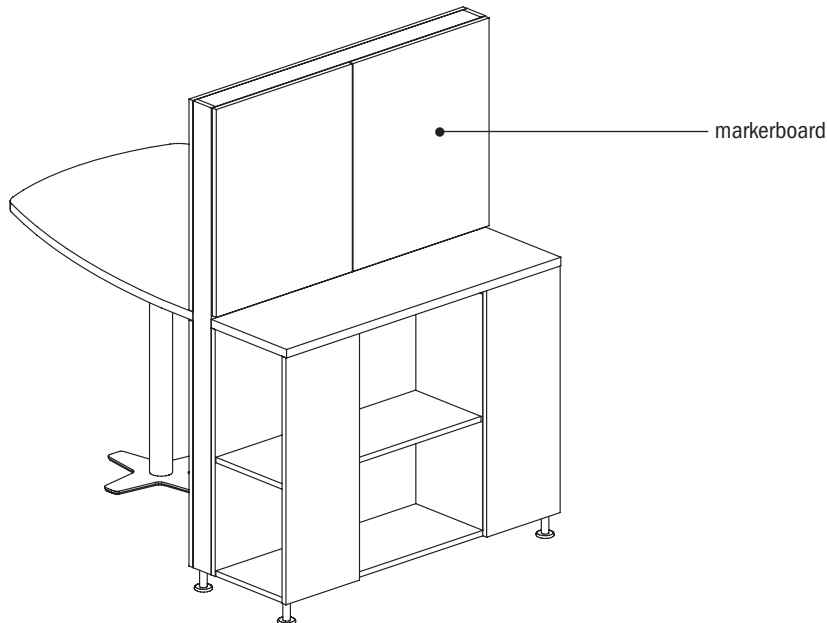

Finish Codes & Availability Chart

		Casegoods Chassis	Casegoods Tops	Wood Feet	Tablet Arms	Arm Caps	Work Shelves	Conical Tops	Conical Bases
Material									
Cherry Veneer	CH1	●	●		●	● ⁰	●	●	polystyrene
Maple Veneer	MA1	●	●	● ⁰	●	● ⁰	●	●	
Walnut Veneer	WA1	●	●		●	● ⁰	●	●	
Laminate		●	●		●		●	●	
Finish (Cherry)									
Autumn*	AUT	●	●	●	●	●	●	●	● ²
Barley*	BRL	●	●	●	●	●	●	●	● ²
Bourbon*	BBN	●	●	●	●	●	●	●	● ²
Brighton*	BRG	●	●	●	●	●	●	●	● ²
Classic*	CLA	●	●	●	●	●	●	●	● ²
Earthy	EAR	●	●	●	●	●	●	●	● ²
Legacy*	LGC	●	●	●	●	●	●	●	● ²
Praline*	PRL	●	●	●	●	●	●	●	● ²
Saffron*	SAF	●	●	●	●	●	●	●	● ²
Finish (Maple)									
Ale*	ALE	●	●	●	●	●	●	●	● ²
Butterscotch	BUT	●	●	●	●	●	●	●	● ²
Cinnamon*	CIN	●	●	●	●	●	●	●	● ²
Flax	FLX	●	●	●	●	●	●	●	● ²
Venetian*	VEN	●	●	●	●	●	●	●	● ²
Finish (Walnut)									
Auburn*	AUB	●	●	●	●	●	●	●	● ²
Espresso	ESP	●	●	●	●	●	●	●	● ²
Mocha*	MCH	●	●	●	●	●	●	●	● ²
Night Owl*	NTO	●	●	●	●	●	●	●	● ²
Sienna*	SIE	●	●	●	●	●	●	●	● ²
Toffee*	TOF	●	●	●	●	●	●	●	● ²
Truffle*	TRF	●	●	●	●	●	●	●	● ²
Laminate									
Alabaster	ALB	●	●		●			●	● ^{1, 2}
Autumn	AUT	●	●		●			●	● ^{1, 2}
Blonde Echo	BLO	●	●		●			●	● ^{1, 2}
Bourbon	BBN	●	●		●			●	● ^{1, 2}
Brazilwood	BZW	●	●		●			●	● ^{1, 2}
Bridal Blanco	BBL	●	●		●			●	● ^{1, 2}
Brighton	BRG	●	●		●			●	● ^{1, 2}
Designer White	DWH	●	●		●		●	●	● ^{1, 2}
Dove Grey	DOV	●	●		●			●	● ^{1, 2}
High Line	HGL	●	●		●			●	● ^{1, 2}
Shadow	SHD	●	●		●		●	●	● ^{1, 2}
Shea	SHE	●	●		●			●	● ^{1, 2}
Slate Grey	SLG	●	●		●		●	●	● ^{1, 2}
Studio Teak	STU	●	●		●			●	● ^{1, 2}
Taupe	TAU	●	●		●			●	● ^{1, 2}
Vintage	VIN	●	●		●			●	● ^{1, 2}
Walnut Heights	WLH	●	●		●			●	● ^{1, 2}
Paint Colors									
Backdrop	BKD							●	● ²
Black Fox	BFX							●	● ²
Bright White	BWH							●	● ²
Cargo Pants	CGP							●	● ²
Chatroom	CHT							●	● ²
French Roast	FRR							●	● ²
Greek Villa	GRV							●	● ²
Network Gray	NET							●	● ²
Nonchalant White	NWH							●	● ²
Storm	STM							●	● ²
Tricorn Black	TRC							●	● ²

* coordinating laminate for tops available

⁰ solid lumber

¹ coordinating laminate finishes

² finish on polystyrene material with imprinted wood grain

Typicals:
MT001

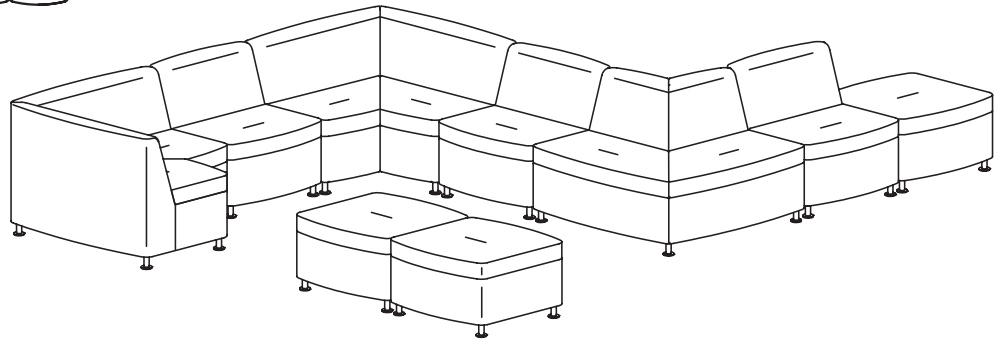
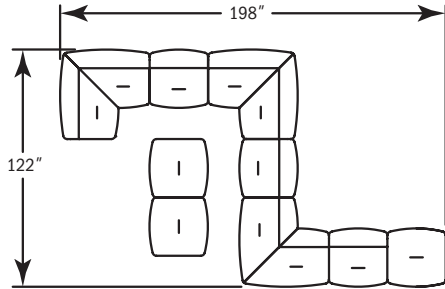

Total List: **\$14,469**

- Models
 (3) MTL300
 (3) MTL301
 (1) MT0901
 (2) MTI901

MT002

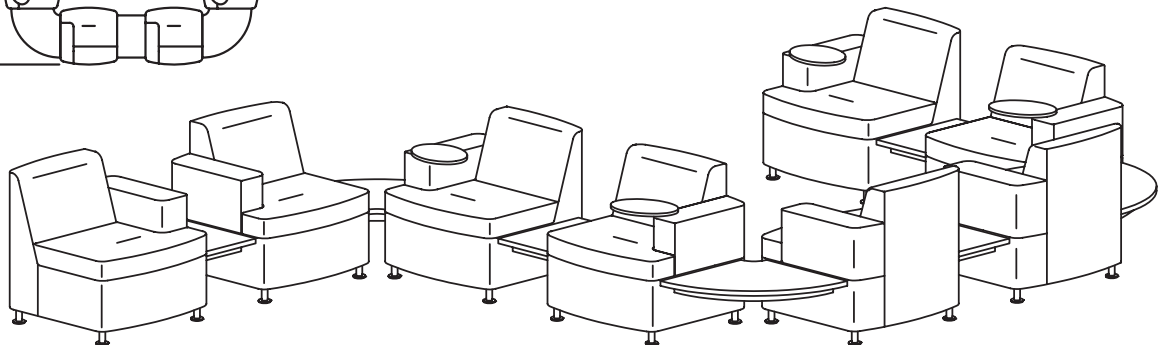
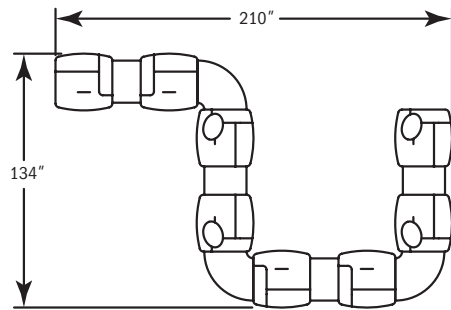

Total List: **\$19,541**

- Models
 (3) MTL301UAL
 (2) MTL301UAL - oval tablet arm
 (1) MTL301UAR
 (2) MTL301UAR - oval tablet arm
 (4) MIT1522LTS - TFL laminate
 (3) MIT2525LTC - TFL laminate

Typicals:

MT003

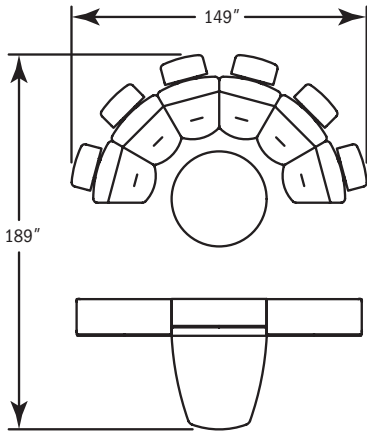

Total List: **\$22,891**

Models

- (1) MTT4866-28MACW - TFL laminate
- (2) MTT1848-58SDC - laminate
- (1) MTVF48ROUN - laminate top
- (6) MTI304 - veneer work shelf
- (3) PX800L

MT004

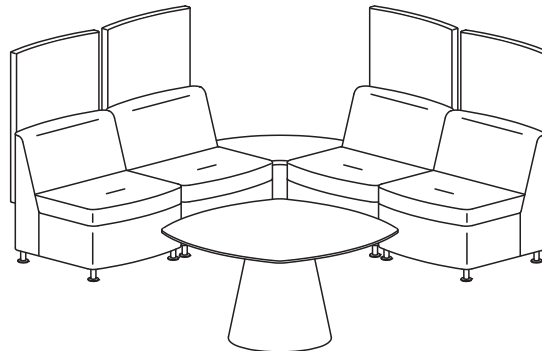
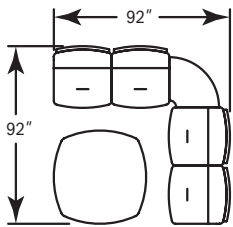

Total List: **\$11,189**

Models

- (4) MTL306 - privacy screen
- (1) MTV2525DTC
- (1) MTVF48SQCL

LOUNGE

Typicals:

MT005

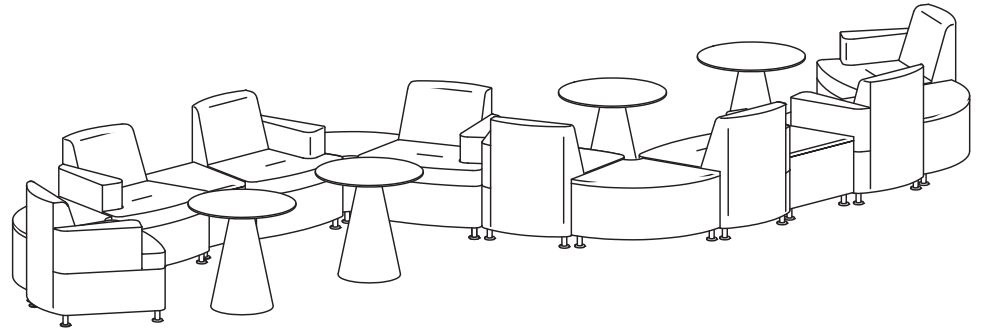
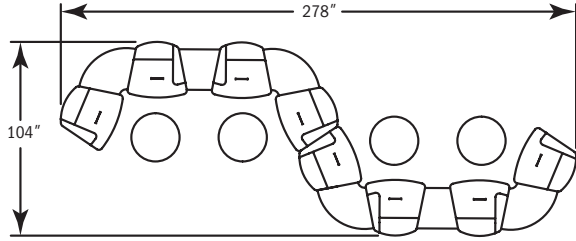

Total List: **\$25,732**

Models

- (4) MTO221UAR
- (4) MTO221UAL
- (4) MTV2525DTC
- (2) MTV2222DTW
- (2) MTVP26ROUN - laminate top

MT006

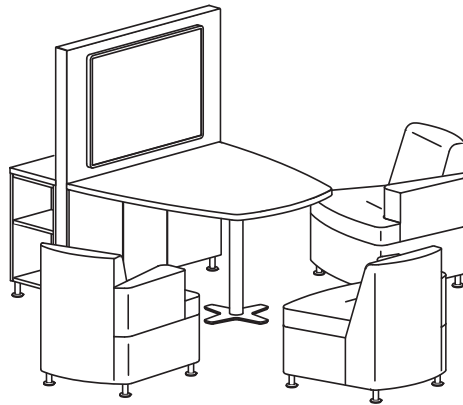
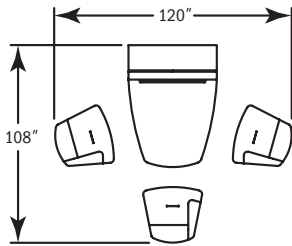

Total List: **\$8,438**

Models

- (2) MTO221UAR
- (1) MTO221UAL
- (1) MTT4866-28MACW - TFL laminate

Typicals:
MT007

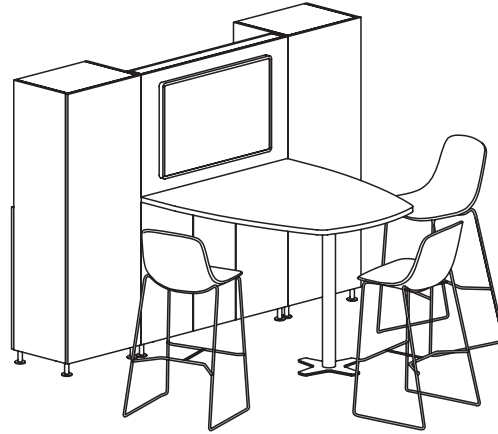
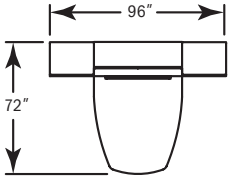

Total List: **\$8,430**

Models

- (1) MTT4872-39MACW - TFL laminate
- (1) MTT1824-68SDR - laminate
- (1) MTT1824-68SDL - laminate
- (3) WK828AP

MT008

LOUNGE

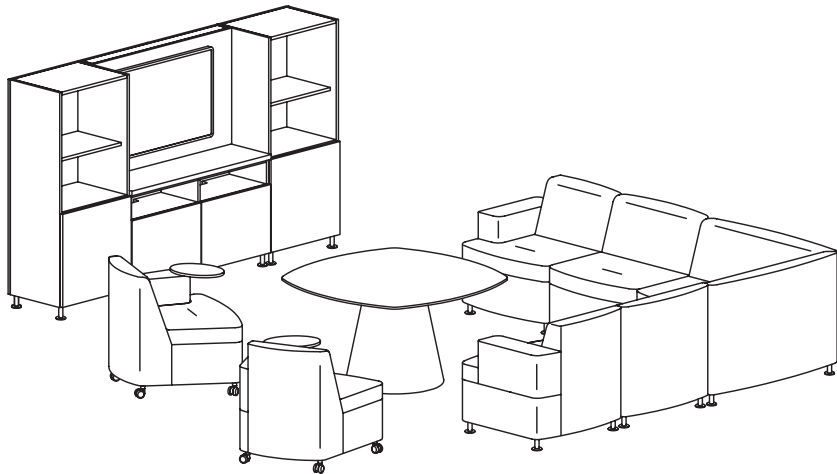
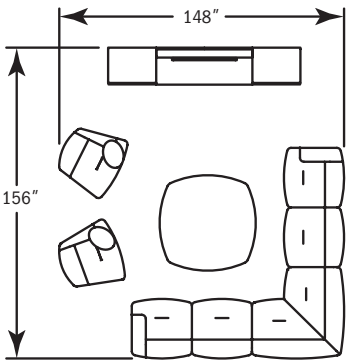

Total List: **\$18,814**

Models

- (1) MTFV48SQCL- laminate top
- (2) MTO221UAL - oval tablet arm and casters
- (1) MTL301UAL
- (1) MTL301UAR
- (2) MTL301
- (1) MTI901
- (1) MTT1848MCW - TFL laminate
- (1) MTT1824-58SDL - TFL laminate
- (1) MTT1824-58SDR - TFL laminate

Typicals:
MT009

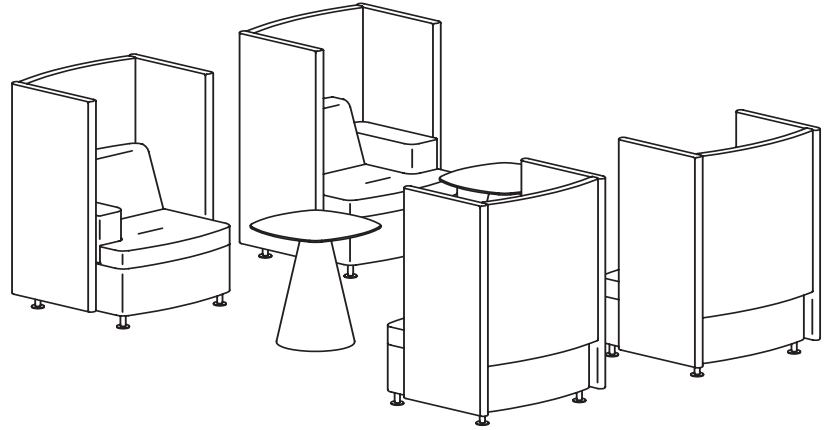
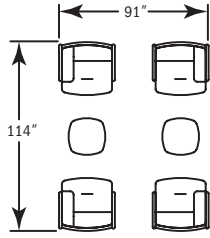

Total List: **\$11,782**

- Models
-
- (2) MTL305UAL
 - (2) MTL305UAR
 - (2) MTVP22SQCL

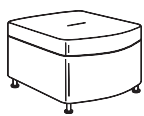
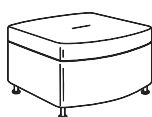
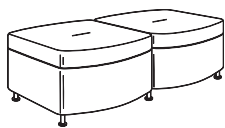
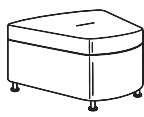
Description	Model	Specifications				List Price Per Grade
Narrow Inline Bench 	MTL260	Dimensions	D	W	H	COM \$1,059
		Overall	30	26	17 ¾	A \$1,082
		Seat	30	26	17 ¾	B \$1,127
		Upholstery	Shipping			COL/C \$1,207
		COM Ydg	2 ¼	Ctn Wt	43	D \$1,309
		COL Sq Ft	45	Cu Ft	11	E \$1,411
				Chair Wt	38	F \$1,569
						G \$1,739
						H \$1,920
						I \$2,203
						J \$2,543
						L1 \$1,863
						L2 \$2,090
Inline Bench 	MTL300	Dimensions	D	W	H	COM \$1,075
		Overall	30	30	17 ¾	A \$1,098
		Seat	30	30	17 ¾	B \$1,143
		Upholstery	Shipping			COL/C \$1,223
		COM Ydg	2 ¼	Ctn Wt	46	D \$1,325
		COL Sq Ft	45	Cu Ft	12	E \$1,426
				Chair Wt	40	F \$1,585
						G \$1,755
						H \$1,936
						I \$2,219
						J \$2,558
						L1 \$1,879
						L2 \$2,106
Two Seat Bench 	MTL600 · casters not available	Dimensions	D	W	H	COM \$1,904
		Overall	30	60	17 ¾	A \$1,950
		Seat	30	60	17 ¾	B \$2,041
		Upholstery	Shipping			COL/C \$2,199
		COM Ydg	4 ½	Ctn Wt	90	D \$2,403
		COL Sq Ft	90	Cu Ft	23	E \$2,607
				Chair Wt	80	F \$2,924
						G \$3,264
						H \$3,626
						I \$4,192
						J \$4,871
						L1 \$3,513
						L2 \$3,966
30° Concave Bench 	MTL300	Dimensions	D	W	H	COM \$1,086
		Overall	30	32	17 ¾	A \$1,109
		Seat	30		17 ¾	B \$1,154
		Upholstery	Shipping			COL/C \$1,234
		COM Ydg	2 ¼	Ctn Wt	42	D \$1,336
		COL Sq Ft	45	Cu Ft	13	E \$1,438
				Chair Wt	37	F \$1,596
						G \$1,767
						H \$1,947
						I \$2,231
						J \$2,570
						L1 \$1,890
						L2 \$2,117

LOUNGE

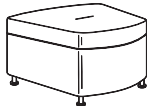
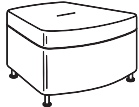
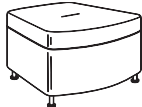
Description	① Model	Specifications				List Price Per Grade
22 ½° Concave Bench 	MTI220	Dimensions	D	W	H	COM \$1,087
		Overall	30	32	17 ¾	A \$1,110
		Seat	30		17 ¾	B \$1,155
		Upholstery	Shipping			COL/C \$1,235
		COM Ydg	2 ¼	Ctn Wt	43	D \$1,337
		COL Sq Ft	45	Cu Ft	13	E \$1,439
				Chair Wt	38	F \$1,598
						G \$1,768
						H \$1,948
						I \$2,232
				J \$2,571		
				L1 \$1,892		
				L2 \$2,118		
30° Convex Bench 	MTO300	Dimensions	D	W	H	COM \$1,086
		Overall	30	32	17 ¾	A \$1,109
		Seat	30		17 ¾	B \$1,154
		Upholstery	Shipping			COL/C \$1,234
		COM Ydg	2 ¼	Ctn Wt	42	D \$1,336
		COL Sq Ft	45	Cu Ft	13	E \$1,438
				Chair Wt	37	F \$1,596
						G \$1,767
						H \$1,947
						I \$2,231
				J \$2,570		
				L1 \$1,890		
				L2 \$2,117		
22 ½° Convex Bench 	MTO220	Dimensions	D	W	H	COM \$1,087
		Overall	30	32	17 ¾	A \$1,110
		Seat	30		17 ¾	B \$1,155
		Upholstery	Shipping			COL/C \$1,235
		COM Ydg	2 ¼	Ctn Wt	43	D \$1,337
		COL Sq Ft	45	Cu Ft	13	E \$1,439
				Chair Wt	38	F \$1,598
						G \$1,768
						H \$1,948
						I \$2,232
				J \$2,571		
				L1 \$1,892		
				L2 \$2,118		



To Order, Specify:

- ① Model Number
- ② Fabric Selection - vendor, pattern and color
 - A. Chair
 - B. Seat Cushion
- ③ Optional Casters; add \$84 list
- ④ Optional Wood Feet; add \$53 list and specify finish
- ⑤ Optional Power Center - Flush Mount (EC22) - Black (B) or White (W); add \$478 list each and specify left or right



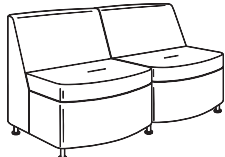

- ② See a selection of graded in fabric manufacturers and patterns on pages 12-20. Contact Customer Service for additional fabric options.

Specifications

- Metal leg standard with 2 ¾" diameter leveling disc.
- Frame is puzzle jointed plywood construction.
- Seat has synthetic sheet webbing with cross strap reinforcement and 3 ¼" multi-density high resilience polyurethane foam.
- Linking bracket included.

Description	① Model	Specifications				List Price Per Grade
Narrow Inline Club Chair	MTL261	Dimensions				COM \$1,306
		D	W	H		A \$1,336
		Overall	30	26	31 1/2	B \$1,397
		Seat	20 1/2	26	17 3/4	COL/C \$1,503
		Upholstery		Shipping		D \$1,638
		COM Ydg	3	Ctn Wt	55	E \$1,774
		COL Sq Ft	60	Cu Ft	18	F \$1,986
				Chair Wt	48	G \$2,212
						H \$2,454
						I \$2,831
						J \$3,284
						L1 \$2,379
						L2 \$2,680
Inline Club Chair	MTL301	Dimensions				COM \$1,322
		D	W	H		A \$1,353
		Overall	30	30	31 1/2	B \$1,414
		Seat	20 1/2	30	17 3/4	COL/C \$1,520
		Upholstery		Shipping		D \$1,655
		COM Ydg	3	Ctn Wt	60	E \$1,791
		COL Sq Ft	60	Cu Ft	20	F \$2,003
				Chair Wt	52	G \$2,229
						H \$2,471
						I \$2,848
						J \$3,301
						L1 \$2,396
						L2 \$2,697
Two Seat Club Chair	MTL601	Dimensions				COM \$2,532
		D	W	H		A \$2,593
	· casters not available	Overall	30	60	31 1/2	B \$2,714
		Seat	20 1/2	60	17 3/4	COL/C \$2,926
		Upholstery		Shipping		D \$3,198
		COM Ydg	6	Ctn Wt	118	E \$3,469
		COL Sq Ft	120	Cu Ft	39	F \$3,892
				Chair Wt	104	G \$4,344
						H \$4,828
						I \$5,583
						J \$6,488
						L1 \$4,677
						L2 \$5,281

LOUNGE

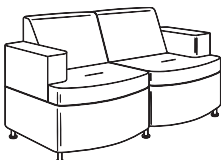
Description	Model	Specifications			List Price Per Grade	
Narrow Inline Club Chair with Arm  Right  Left	MTL261UAR MTL261UAL	Dimensions	D	W	H	COM \$1,431
		Overall	30	26	31 ½	A \$1,464
		Seat	20 ½	20	17 ¾	B \$1,529
		Upholstery	Shipping			COL/C \$1,644
		COM Ydg	3 ¼	Ctn Wt	67	D \$1,791
		COL Sq Ft	65	Cu Ft	18	E \$1,939
				Chair Wt	60	F \$2,168
						G \$2,412
						H \$2,675
						I \$3,083
						J \$3,574
						L1 \$2,593
						L2 \$2,919
Inline Club Chair with Arm  Right  Left	MTL301UAR MTL301UAL	Dimensions	D	W	H	COM \$1,473
		Overall	30	30	31 ½	A \$1,511
		Seat	20 ½	23	17 ¾	B \$1,587
		Upholstery	Shipping			COL/C \$1,718
		COM Ydg	3 ¾	Ctn Wt	75	D \$1,888
		COL Sq Ft	75	Cu Ft	20	E \$2,058
				Chair Wt	67	F \$2,323
						G \$2,606
						H \$2,908
						I \$3,379
						J \$3,945
						L1 \$2,813
						L2 \$3,190
Two Seat Club Chair with Arms 	MTL601UA • casters not available	Dimensions	D	W	H	COM \$2,726
		Overall	30	60	31 ½	A \$2,792
		Seat	20 ½	46	17 ¾	B \$2,924
		Upholstery	Shipping			COL/C \$3,153
		COM Ydg	6 ½	Ctn Wt	148	D \$3,447
		COL Sq Ft	130	Cu Ft	39	E \$3,742
				Chair Wt	134	F \$4,199
						G \$4,690
						H \$5,214
						I \$6,032
						J \$7,012
						L1 \$5,050
						L2 \$5,704

To Order, Specify:

- 1 Model Number
- 2 Fabric Selection - vendor, pattern and color
 - A. Chair
 - B. Seat Cushion
- 3 Optional Casters; add \$84 list
- 4 Optional Wood Feet; add \$53 list and specify finish
- 5 Optional Tablet Arm, Oval or Rectangular; specify shape, material, finish and add \$538 list ▲
- 6 Optional Arm Cap; specify wood species, finish and add \$242 list per arm
- 7 Optional Power Center - Flush Mount (EC22) - Black (B) or White (W); add \$478 list each and specify left or right

- 2 See a selection of graded fabric manufacturers and patterns on pages 12-20. Contact Customer Service for additional fabric options.

Specifications

- Metal leg standard with 2 ¾" diameter leveling disc.
- Frame is puzzle jointed plywood construction.
- Seat has synthetic sheet webbing with cross strap reinforcement and 3 ¼" multi-density high resilience polyurethane foam.
- Back has 1 ¾" multi-density high resilience polyurethane foam.
- Upholstered arms are standard.
- Arm tops have 1" high resilience polyurethane foam.
- Optional arm cap is available in Maple, Walnut or Cherry.
- Optional tablet arm is available in Maple, Walnut, Cherry veneer, or HPL with exposed plywood edges.
- Linking bracket included.

Description	Model	Specifications			List Price Per Grade	
30° Concave Club Chair	MTI301	Dimensions			COM \$1,328	
		D	W	H	A \$1,358	
		Overall	30	32	31 1/2	B \$1,419
		Seat	20 1/2		17 3/4	COL/C \$1,525
		Upholstery		Shipping	D \$1,661	
		COM Ydg	3	Ctn Wt	57	E \$1,796
		COL Sq Ft	60	Cu Ft	22	F \$2,008
				Chair Wt	48	G \$2,234
						H \$2,476
						I \$2,853
						J \$3,306
						L1 \$2,401
						L2 \$2,702

22 1/2° Concave Club Chair	MTI221	Dimensions			COM \$1,331	
		D	W	H	A \$1,361	
		Overall	30	32	31 1/2	B \$1,422
		Seat	20 1/2		17 3/4	COL/C \$1,528
		Upholstery		Shipping	D \$1,664	
		COM Ydg	3	Ctn Wt	59	E \$1,799
		COL Sq Ft	60	Cu Ft	22	F \$2,011
				Chair Wt	50	G \$2,237
						H \$2,480
						I \$2,856
						J \$3,309
						L1 \$2,404
						L2 \$2,705

Description

1 Model

Specifications

List Price Per Grade

30° Concave Club Chair with Arm

MTI301UAR
MTI301UAL

· tablet arm not available

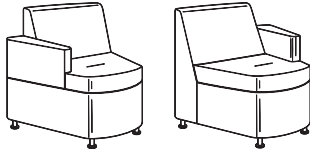

Right

Left

Dimensions	D	W	H
Overall	30	32	31 1/2
Seat	20 1/2		17 3/4
Upholstery		Shipping	
COM Ydg	3 3/4	Ctn Wt	72
COL Sq Ft	75	Cu Ft	22
		Chair Wt	63

COM	\$1,464
A	\$1,503
B	\$1,579
COL/C	\$1,710
D	\$1,880
E	\$2,050
F	\$2,315
G	\$2,597
H	\$2,900
I	\$3,371
J	\$3,937
L1	\$2,805
L2	\$3,182

22 1/2° Concave Club Chair with Arm

MTI221UAR
MTI221UAL

· tablet arm not available

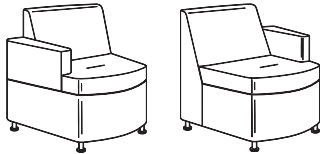

Right

Left

Dimensions	D	W	H
Overall	30	32	31 1/2
Seat	20 1/2		17 3/4
Upholstery		Shipping	
COM Ydg	3 3/4	Ctn Wt	74
COL Sq Ft	75	Cu Ft	22
		Chair Wt	65

COM	\$1,469
A	\$1,508
B	\$1,584
COL/C	\$1,715
D	\$1,885
E	\$2,055
F	\$2,320
G	\$2,602
H	\$2,905
I	\$3,376
J	\$3,942
L1	\$2,810
L2	\$3,187

To Order, Specify:

- 1 Model Number
- 2 Fabric Selection - vendor, pattern and color
 - A. Chair
 - B. Seat Cushion
- 3 Optional Casters; add \$84 list
- 4 Optional Wood Feet; add \$53 list and specify finish
- 5 Optional Arm Cap; specify wood species, finish and add \$242 list per arm
- 6 Optional Power Center - Flush Mount (EC22) - Black (B) or White (W); add \$478 list each and specify left or right



- 2 See a selection of graded in fabric manufacturers and patterns on pages 12-20. Contact Customer Service for additional fabric options.



Specifications

- Metal leg standard with 2 3/8" diameter leveling disc.
- Frame is puzzle jointed plywood construction.
- Seat has synthetic sheet webbing with cross strap reinforcement and 3 1/4" multi-density high resilience polyurethane foam.
- Back has 1 3/4" multi-density high resilience polyurethane foam.
- Upholstered arms are standard.
- Arm tops have 1" high resilience polyurethane foam.
- Optional arm cap is available in Maple, Walnut or Cherry.
- Optional tablet arm is available in Maple, Walnut, Cherry veneer, or HPL with exposed plywood edges.
- Linking bracket included.

Description	Model	Specifications			List Price Per Grade	
30° Convex Club Chair	MT0301	Dimensions	D	W	H	COM \$1,316
		Overall	30	32	31 1/2	A \$1,347
		Seat	20 1/2		17 3/4	B \$1,407
		Upholstery	Shipping			COL/C \$1,514
		COM Ydg	3	Ctn Wt	56	D \$1,649
		COL Sq Ft	60	Cu Ft	22	E \$1,784
				Chair Wt	47	F \$1,997
						G \$2,222
						H \$2,465
						I \$2,842
						J \$3,294
						L1 \$2,389
						L2 \$2,691

22 1/2° Convex Club Chair	MT0221	Dimensions	D	W	H	COM \$1,323
		Overall	30	32	31 1/2	A \$1,354
		Seat	20 1/2		17 3/4	B \$1,415
		Upholstery	Shipping			COL/C \$1,521
		COM Ydg	3	Ctn Wt	57	D \$1,656
		COL Sq Ft	60	Cu Ft	22	E \$1,792
				Chair Wt	48	F \$2,004
						G \$2,230
						H \$2,472
						I \$2,849
						J \$3,302
						L1 \$2,397
						L2 \$2,698

Description		Model	Specifications			List Price Per Grade	
30° Convex Club Chair with Arm		MT0301UAR MT0301UAL	Dimensions	D	W	H	COM \$1,446
			Overall	30	32	31 1/2	A \$1,480
			Seat	20 1/2		17 3/4	B \$1,545
			Upholstery	Shipping			COL/C \$1,659
			COM Ydg	3 1/4	Ctn Wt	71	D \$1,806
			COL Sq Ft	65	Cu Ft	22	E \$1,955
					Chair Wt	62	F \$2,183
						G \$2,428	
						H \$2,691	
						I \$3,099	
						J \$3,589	
						L1 \$2,609	
						L2 \$2,935	

22 1/2° Convex Club Chair with Arm	MT0221UAR MT0221UAL	Dimensions	D	W	H	COM \$1,452	
			Overall	30	32	31 1/2	A \$1,485
			Seat	20 1/2		17 3/4	B \$1,550
			Upholstery	Shipping			COL/C \$1,665
			COM Ydg	3 1/4	Ctn Wt	71	D \$1,812
			COL Sq Ft	65	Cu Ft	22	E \$1,960
					Chair Wt	62	F \$2,189
						G \$2,433	
						H \$2,696	
						I \$3,104	
						J \$3,595	
						L1 \$2,614	
						L2 \$2,940	

LOUNGE

Description

1 Model

Specifications

List Price Per Grade

90° Convex Corner

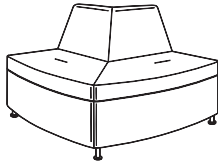

MT0901

· casters not available

Dimensions	D	W	H
Overall	46	46	31½
Seat	20½		17¾
Upholstery		Shipping	
COM Ydg	5	Ctn Wt	122
COL Sq Ft	100	Cu Ft	45
		Chair Wt	107

COM	\$2,376
A	\$2,427
B	\$2,528
COL/C	\$2,703
D	\$2,930
E	\$3,157
F	\$3,509
G	\$3,887
H	\$4,289
I	\$4,918
J	\$5,673
L1	\$4,163
L2	\$4,667

90° Concave Corner

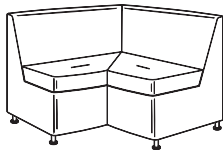

MTI901

· casters not available

Dimensions	D	W	H
Overall	46	46	31½
Seat	20½		17¾
Upholstery		Shipping	
COM Ydg	6¼	Ctn Wt	132
COL Sq Ft	125	Cu Ft	45
		Chair Wt	117

COM	\$2,451
A	\$2,515
B	\$2,641
COL/C	\$2,861
D	\$3,144
E	\$3,428
F	\$3,868
G	\$4,339
H	\$4,843
I	\$5,630
J	\$6,572
L1	\$4,686
L2	\$5,315

To Order, Specify:

- 1 Model Number
- 2 Fabric Selection - vendor, pattern and color
 - A. Chair
 - B. Seat Cushion
- 3 Optional Casters; add \$84 list
- 4 Optional Wood Feet; add \$53 list and specify finish
- 5 Optional Tablet Arm, Oval or Rectangular; specify shape, material, finish and add \$538 list ▲
- 6 Optional Arm Cap; specify wood specie
- 6 Optional Arm Cap; specify wood species, finish and add \$242 list per arm
- 7 Optional Power Center - Flush Mount (EC22) - Black (B) or White (W); add \$478 list each and specify left or right

- 2 See a selection of graded in fabric manufacturers and patterns on pages 12-20. Contact Customer Service for additional fabric options.

Specifications

- Metal leg standard with 2¾" diameter leveling disc.
- Frame is puzzle jointed plywood construction.
- Seat has synthetic sheet webbing with cross strap reinforcement and 3¼" multi-density high resilience polyurethane foam.
- Back has 1¾" multi-density high resilience polyurethane foam.
- Upholstered arms are standard.
- Arm tops have 1" high resilience polyurethane foam.
- Optional arm cap is available in Maple, Walnut or Cherry.
- Optional tablet arm is available in Maple, Walnut, Cherry veneer, or HPL with exposed plywood edges.
- Linking bracket included.

Description	Model	Specifications			List Price Per Grade		
Narrow Inline Club Chair with Work Shelf 	MTL264 · casters not available	Dimensions			COM	\$1,968	
		Overall	41 ¼	26	39	A	\$1,999
		Seat	20 ½	26	17 ¾	B	\$2,060
		Upholstery		Shipping		COL/C	\$2,166
		COM Ydg	3	Ctn Wt	93	D	\$2,301
		COL Sq Ft	60	Cu Ft	23	E	\$2,436
				Chair Wt	83	F	\$2,649
						G	\$2,874
						H	\$3,117
						I	\$3,494
						J	\$3,946
						L1	\$3,041
						L2	\$3,343

Description	Model	Specifications			List Price Per Grade		
Inline Club Chair with Work Shelf 	MTL304 · casters not available	Dimensions			COM	\$1,984	
		Overall	41 ¼	30	39	A	\$2,014
		Seat	20 ½	30	17 ¾	B	\$2,075
		Upholstery		Shipping		COL/C	\$2,181
		COM Ydg	3	Ctn Wt	94	D	\$2,317
		COL Sq Ft	60	Cu Ft	25	E	\$2,452
				Chair Wt	87	F	\$2,664
						G	\$2,890
						H	\$3,133
						I	\$3,510
						J	\$3,962
						L1	\$3,057
						L2	\$3,358

Description

1 Model

Specifications

List Price Per Grade

Narrow Inline Club Chair with Arm and Work Shelf

MTL264UAR
MTL264UAL

• casters not available

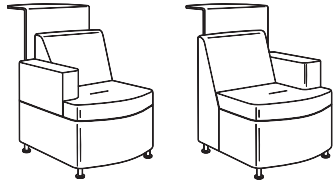

Right

Left

Dimensions	D	W	H
Overall	41 ¼	26	39
Seat	20 ½	20	17 ¾
Upholstery		Shipping	
COM Ydg	3 ¾	Ctn Wt	106
COL Sq Ft	65	Cu Ft	23
		Chair Wt	95

COM	\$2,092
A	\$2,126
B	\$2,191
COL/C	\$2,305
D	\$2,452
E	\$2,600
F	\$2,829
G	\$3,074
H	\$3,336
I	\$3,745
J	\$4,235
L1	\$3,254
L2	\$3,581

Inline Club Chair with Arm and Work Shelf

MTL304UAR
MTL304UAL

• casters not available

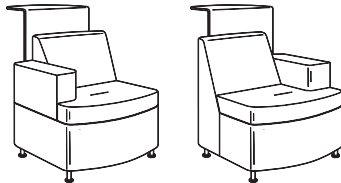

Right

Left

Dimensions	D	W	H
Overall	41 ¼	30	39
Seat	20 ½	23	17 ¾
Upholstery		Shipping	
COM Ydg	3 ¾	Ctn Wt	112
COL Sq Ft	75	Cu Ft	25
		Chair Wt	102

COM	\$2,134
A	\$2,173
B	\$2,249
COL/C	\$2,380
D	\$2,550
E	\$2,720
F	\$2,985
G	\$3,267
H	\$3,569
I	\$4,041
J	\$4,607
L1	\$3,475
L2	\$3,852

To Order, Specify:

- 1 Model Number
- 2 Fabric Selection - vendor, pattern and color
 - A. Chair
 - B. Seat Cushion
- 3 Optional Wood Feet; add \$53 list and specify finish
- 4 Optional Tablet Arm, Oval or Rectangular; specify shape, material, finish and add \$538 list ▲
- 5 Optional Arm Cap; specify wood species, finish and add \$242 list per arm
- 6 Optional Power Center - Flush Mount (EC22) - Black (B) or White (W);.
 - Side of Seating; add \$478 list each and specify right or left
 - Back of Work Shelf; add \$529 list each
- 7 Work Shelf Wood Species - Cherry (CH1), Maple (MA1) or Walnut (WA1)
- 8 Work Shelf Wood Finish
- 9 Work Shelf Laminate Color Selection
- 10 Optional Work Shelf Acrylic Screen; add \$191 list

- 2 See a selection of graded in fabric manufacturers and patterns on pages 12-20. Contact Customer Service for additional fabric options.

8 Work Shelf Wood Finish Options:

Cherry	Maple
AUT Autumn	ALE Ale
BRL Barley	BUT Butterscotch
BBN Bourbon	CIN Cinnamon
BRG Brighton	FLX Flax
CLA Classic	VEN Venetian
EAR Earthy	
LGC Legacy	
PRL Praline	
SAF Saffron	
Walnut	
AUB Auburn	
ESP Espresso	
MCH Mocha	
NTO Night Owl	
SIE Sienna	
TOF Toffee	
TRF Truffle	

9 Work Shelf Laminate Color Selection:

DWH Designer White
SHD Shadow
SLG Slate Grey

Specifications

- Metal leg standard with 2 ¾" diameter leveling disc.
- Frame is puzzle jointed plywood construction.
- Seat has synthetic sheet webbing with cross strap reinforcement and 3 ¼" multi-density high resilience polyurethane foam.
- Back has 1 ¾" multi-density high resilience polyurethane foam.
- Upholstered arms are standard.
- Arm tops have 1" high resilience polyurethane foam.
- Optional arm cap is available in Maple, Walnut or Cherry.
- Optional tablet arm is available in Maple, Walnut, Cherry veneer, or HPL with exposed plywood edges.
- 39" high rear work shelf is available in Maple, Cherry, Walnut veneer or solid color HPL with exposed plywood edges.
- Work shelf is field installed.
- Work shelf dimensions 9 ½" x 22"
- Optional frosted acrylic screen with brushed aluminum standoffs is 4 ¾" ▲ tall
- Linking bracket included.

Description

1 Model

Specifications

List Price Per Grade

30° Concave Club Chair with Work Shelf

MTI304
· casters not available

Dimensions	D	W	H
Overall	41 ¼	32	39
Seat	20 ½		17 ¾
Upholstery		Shipping	
COM Ydg	3	Ctn Wt	95
COL Sq Ft	60	Cu Ft	27
		Chair Wt	83

- COM \$1,989
- A \$2,020
- B \$2,081
- COL/C \$2,187
- D \$2,322
- E \$2,457
- F \$2,670
- G \$2,895
- H \$3,138
- I \$3,515
- J \$3,967
- L1 \$3,062
- L2 \$3,364



22 ½° Concave Club Chair with Work Shelf

MTI224
· casters not available

Dimensions	D	W	H
Overall	41 ¼	32	39
Seat	20 ½		17 ¾
Upholstery		Shipping	
COM Ydg	3	Ctn Wt	97
COL Sq Ft	60	Cu Ft	27
		Chair Wt	85

- COM \$1,999
- A \$2,029
- B \$2,090
- COL/C \$2,196
- D \$2,331
- E \$2,467
- F \$2,679
- G \$2,905
- H \$3,147
- I \$3,524
- J \$3,977
- L1 \$3,072
- L2 \$3,373



Description

1 Model

Specifications

List Price Per Grade

30° Concave Club Chair with Arm and Work Shelf

MTI304UAR
MTI304UAL

- casters not available
- tablet arm not available

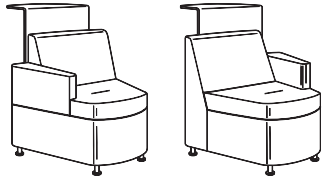

Right

Left

Dimensions	D	W	H
Overall	41 ¼	32	39
Seat	20 ½		17 ¾
Upholstery		Shipping	
COM Ydg	3 ¾	Ctn Wt	110
COL Sq Ft	75	Cu Ft	27
		Chair Wt	98

COM	\$2,127
A	\$2,166
B	\$2,241
COL/C	\$2,372
D	\$2,543
E	\$2,713
F	\$2,977
G	\$3,260
H	\$3,562
I	\$4,034
J	\$4,599
L1	\$3,468
L2	\$3,845

22 ½° Concave Club Chair with Arm and Work Shelf

MTI224UAR
MTI224UAL

- casters not available
- tablet arm not available

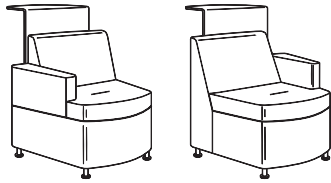

Right

Left

Dimensions	D	W	H
Overall	41 ¼	32	39
Seat	20 ½		17 ¾
Upholstery		Shipping	
COM Ydg	3 ¾	Ctn Wt	112
COL Sq Ft	75	Cu Ft	27
		Chair Wt	100

COM	\$2,131
A	\$2,170
B	\$2,245
COL/C	\$2,377
D	\$2,547
E	\$2,717
F	\$2,981
G	\$3,264
H	\$3,566
I	\$4,038
J	\$4,604
L1	\$3,472
L2	\$3,849

To Order, Specify:

- Model Number
- Fabric Selection - vendor, pattern and color
 - Chair
 - Seat Cushion
- Optional Wood Feet; add \$53 list and specify finish
- Optional Arm Cap; specify wood species, finish and add \$242 list per arm
- Optional Power Center - Flush Mount (EC22) - Black (B) or White (W);
 - Side of Seating; add \$478 list each and specify right or left
 - Back of Work Shelf; add \$529 list each
- Work Shelf Wood Species - Cherry (CH1), Maple (MA1) or Walnut (WA1)
- Work Shelf Wood Finish
- Work Shelf Laminate Color Selection
- Optional Work Shelf Acrylic Screen; add \$191 list

- See a selection of graded in fabric manufacturers and patterns on pages 12-20. Contact Customer Service for additional fabric options.

7 Work Shelf Wood Finish Options:

Cherry	Maple
AUT Autumn	ALE Ale
BRL Barley	BUT Butterscotch
BBN Bourbon	CIN Cinnamon
BRG Brighton	FLX Flax
CLA Classic	VEN Venetian
EAR Earthy	
LGC Legacy	
PRL Praline	
SAF Saffron	
Walnut	
AUB Auburn	
ESP Espresso	
MCH Mocha	
NTO Night Owl	
SIE Sienna	
TOF Toffee	
TRF Truffle	

8 Work Shelf Laminate Color Selection:

DWH Designer White
SHD Shadow
SLG Slate Grey

Specifications

- Metal leg standard with 2 ¾" diameter leveling disc.
- Frame is puzzle jointed plywood construction.
- Seat has synthetic sheet webbing with cross strap reinforcement and 3 ¼" multi-density high resilience polyurethane foam.
- Back has 1 ¾" multi-density high resilience polyurethane foam.
- Upholstered arms are standard.
- Arm tops have 1" high resilience polyurethane foam.
- Optional arm cap is available in Maple, Walnut or Cherry.
- 39" high rear work shelf is available in Maple, Cherry, Walnut veneer or solid color HPL with exposed plywood edges.
- Work shelf is field installed.
- Work shelf dimensions 9 ½" x 22"
- Optional frosted acrylic screen with brushed aluminum standoffs is 4 ¾" ▲ tall
- Linking bracket included.

Description

1 Model

Specifications

List Price Per Grade

Inline Club Chair with Privacy Screen

MTL306
· casters not available

Dimensions	D	W	H
Overall	31 ¾	30	50
Seat	20 ½	30	17 ¾
Upholstery		Shipping	
COM Ydg	5 ¼	Ctn Wt	78
COL Sq Ft	105	Cu Ft	24
		Chair Wt	67

COM	\$1,770
A	\$1,823
B	\$1,929
COL/C	\$2,114
D	\$2,351
E	\$2,590
F	\$2,959
G	\$3,356
H	\$3,778
I	\$4,440
J	\$5,232
L1	\$3,647
L2	\$4,175

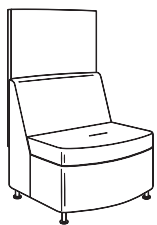

30° Concave Club Chair with Privacy Screen

MTI306
· casters not available

Dimensions	D	W	H
Overall	31 ¾	32	50
Seat	20 ½		17 ¾
Upholstery		Shipping	
COM Ydg	5 ¼	Ctn Wt	74
COL Sq Ft	105	Cu Ft	26
		Chair Wt	63

COM	\$1,774
A	\$1,827
B	\$1,934
COL/C	\$2,118
D	\$2,356
E	\$2,594
F	\$2,964
G	\$3,360
H	\$3,783
I	\$4,444
J	\$5,236
L1	\$3,651
L2	\$4,179

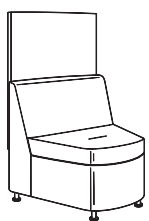

22 ½° Concave Club Chair with Privacy Screen

MTI226
· casters not available

Dimensions	D	W	H
Overall	31 ¾	32	50
Seat	20 ½		17 ¾
Upholstery		Shipping	
COM Ydg	5 ¼	Ctn Wt	76
COL Sq Ft	105	Cu Ft	26
		Chair Wt	65

COM	\$1,777
A	\$1,831
B	\$1,937
COL/C	\$2,121
D	\$2,359
E	\$2,597
F	\$2,967
G	\$3,364
H	\$3,786
I	\$4,447
J	\$5,239
L1	\$3,654
L2	\$4,183

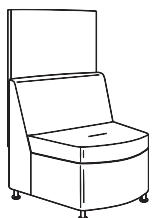

LOUNGE

Description

1 Model

Specifications

List Price Per Grade

Inline Club Chair with Arm and Privacy Screen

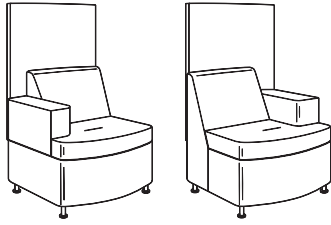

Right

Left

MTL306UAR
MTL306UAL

• casters not available

Dimensions	D	W	H
Overall	31 ¾	30	50
Seat	20 ½	23	17 ¾
Upholstery		Shipping	
COM Ydg	6	Ctn Wt	93
COL Sq Ft	120	Cu Ft	24
		Chair Wt	82

COM	\$1,875
A	\$1,936
B	\$2,056
COL/C	\$2,268
D	\$2,540
E	\$2,811
F	\$3,234
G	\$3,687
H	\$4,171
I	\$4,926
J	\$5,831
L1	\$4,020
L2	\$4,624

30° Concave Club Chair with Arm and Privacy Screen

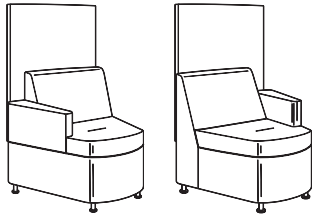

Right

Left

MTI306UAR
MTI306UAL

• casters not available
• tablet arm not available

Dimensions	D	W	H
Overall	31 ¾	32	50
Seat	20 ½		17 ¾
Upholstery		Shipping	
COM Ydg	6	Ctn Wt	89
COL Sq Ft	120	Cu Ft	26
		Chair Wt	78

COM	\$1,911
A	\$1,972
B	\$2,093
COL/C	\$2,305
D	\$2,577
E	\$2,848
F	\$3,271
G	\$3,724
H	\$4,208
I	\$4,963
J	\$5,868
L1	\$4,057
L2	\$4,660

22 ½° Concave Club Chair with Arm and Privacy Screen

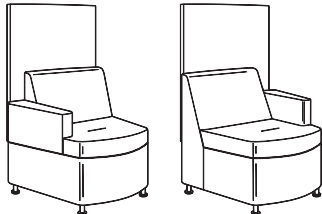

Right

Left

MTI226UAR
MTI226UAL

• casters not available
• tablet arm not available

Dimensions	D	W	H
Overall	31 ¾	32	50
Seat	20 ½		17 ¾
Upholstery		Shipping	
COM Ydg	6	Ctn Wt	91
COL Sq Ft	120	Cu Ft	26
		Chair Wt	80

COM	\$1,916
A	\$1,977
B	\$2,097
COL/C	\$2,309
D	\$2,581
E	\$2,852
F	\$3,275
G	\$3,728
H	\$4,212
I	\$4,967
J	\$5,872
L1	\$4,061
L2	\$4,665

To Order, Specify:

- 1 Model Number
- 2 Fabric Selection - vendor, pattern and color
 - A. Chair
 - B. Seat Cushion
 - C. Privacy Screen
- 3 Optional Wood Feet; add \$53 list and specify finish
- 4 Optional Tablet Arm, Oval or Rectangular; specify shape, material, finish and add \$538 list ▲
- 5 Optional Arm Cap; specify wood species, finish and add \$242 list per arm
- 6 Optional Power Center - Flush Mount (EC22) - Black (B) or White (W); add \$478 list each and specify left or right

- 2 See a selection of graded in fabric manufacturers and patterns on pages 12-20. Contact Customer Service for additional fabric options.

Specifications

- Metal leg standard with 2 ¾" diameter leveling disc.
- Frame is puzzle jointed plywood construction.
- Seat has synthetic sheet webbing with cross strap reinforcement and 3 ¼" multi-density high resilience polyurethane foam.
- Back has 1 ¾" multi-density high resilience polyurethane foam.
- Upholstered arms are standard.
- Arm tops have 1" high resilience polyurethane foam.
- Optional arm cap is available in Maple, Walnut or Cherry.
- Optional tablet arm is available in Maple, Walnut, Cherry veneer, or HPL with exposed plywood edges.
- Upholstered privacy screen has polyurethane foam.
- Screen is field installed.
- Linking bracket included.

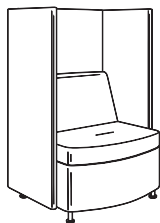
Description	Model	Specifications				List Price Per Grade	
Inline Club Chair with Privacy Surround	MTL305	Dimensions		D	W	H	COM \$2,234
		Overall	31 ¾	33 ½	50	A \$2,316	B \$2,476
		Seat	20 ½	30	17 ¾	COL/C \$2,758	D \$3,121
		Upholstery		Shipping		E \$3,483	F \$4,047
		COM Ydg	8 ¼ ▲	Ctn Wt	118	G \$4,651	H \$5,295
		COL Sq Ft	166 ▲	Cu Ft	37	I \$6,302	J \$7,509
				Chair Wt	107	L1 \$5,094	L2 \$5,899

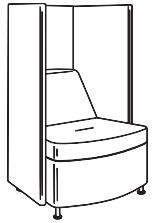
22 ½° Convex Club Chair with Privacy Surround	MT0225	Dimensions		D	W	H	COM \$2,214
		Overall	31 ¾	33 ½	50	A \$2,296	B \$2,456
		Seat	20 ½		17 ¾	COL/C \$2,738	D \$3,101
		Upholstery		Shipping		E \$3,463	F \$4,027
		COM Ydg	8 ¼ ▲	Ctn Wt	115	G \$4,631	H \$5,275
		COL Sq Ft	166 ▲	Cu Ft	37	I \$6,282	J \$7,489
				Chair Wt	102	L1 \$5,074	L2 \$5,879

Description

1 Model

Specifications

List Price Per Grade

Inline Club Chair with Arm and Privacy Surround

MTL305UAR
MTL305UAL

· tablet arm not available

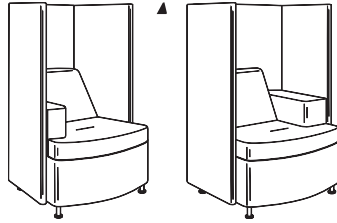

Right

Left

Dimensions	D	W	H
Overall	31 ¾	33 ½	50
Seat	20 ½	23	17 ¾
Upholstery		Shipping	
COM Ydg	9 ▲	Ctn Wt	133
COL Sq Ft	181 ▲	Cu Ft	37
		Chair Wt	122

COM	\$2,384
A	\$2,473
B	\$2,650
COL/C	\$2,957
D	\$3,354
E	\$3,750
F	\$4,366
G	\$5,028
H	\$5,732
I	\$6,833
J	\$8,154
L1	\$5,512
L2	\$6,393

22 ½° Convex Club Chair with Arm and Privacy Surround

MT0225UAR
MT0225UAL

· tablet arm not available

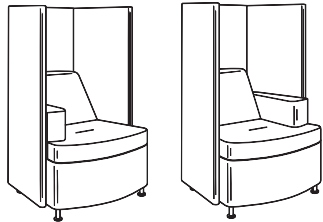

Right

Left

Dimensions	D	W	H
Overall	31 ¾	33 ½	50
Seat	20 ½		17 ¾
Upholstery		Shipping	
COM Ydg	8 ½ ▲	Ctn Wt	130
COL Sq Ft	171 ▲	Cu Ft	37
		Chair Wt	117

COM	\$2,342
A	\$2,426
B	\$2,592
COL/C	\$2,883
D	\$3,257
E	\$3,630
F	\$4,211
G	\$4,835
H	\$5,498
I	\$6,537
J	\$7,782
L1	\$5,291
L2	\$6,122

To Order, Specify:

- 1 Model Number
- 2 Fabric Selection - vendor, pattern and color
 - A. Chair
 - B. Seat Cushion
 - C. Privacy Surround
- 3 Optional Casters; add \$84 list
- 4 Optional Wood Feet; add \$53 list and specify finish
- 5 Optional Arm Cap; specify wood species, finish and add \$242 list per arm
- 6 Optional Power Center - Flush Mount (EC22) - Black (B) or White (W); add \$504 list each and specify left or right.

- 2 See a selection of graded in fabric manufacturers and patterns on pages 12-20. Contact Customer Service for additional fabric options.

Specifications

- Metal leg standard with 2 ¾" diameter leveling disc.
- Frame is puzzle jointed plywood construction.
- Seat has synthetic sheet webbing with cross strap reinforcement and 3 ¼" multi-density high resilience polyurethane foam.
- Back has 1 ¾" multi-density high resilience polyurethane foam.
- Upholstered arms are standard.
- Arm tops have 1" high resilience polyurethane foam.
- Optional arm cap is available in Maple, Walnut or Cherry.
- Upholstered privacy screen has polyurethane foam.

Description	D	W	H	CTN WT	CU FT	① Model	Veneer List Price
Linking Drum Table	25 13/16	25 13/16	15	48	9	MTV2525DTC	\$2,401



- quarter round
- power unit available, see page 374

Linking Drum Table	22 1/4	15	15	40	5	MTV1522DTS	\$923
--------------------	--------	----	----	----	---	------------	-------

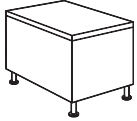

- rectangle
- power unit available, see page 374

Linking Drum Table	22 1/4	22 1/4	15	47	6	MTV2230DTW	\$1,110
--------------------	--------	--------	----	----	---	------------	---------

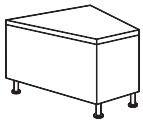

- 30° wedge
- power unit available, see page 374

Linking Drum Table	22 1/4	22 1/4	15	49	6	MTV2222DTW	\$1,115
--------------------	--------	--------	----	----	---	------------	---------

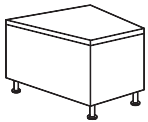

- 22 1/2° wedge
- power unit available, see page 374

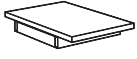
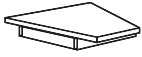
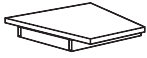
Description	D	W	H	CTN WT	CU FT	① Model	Veneer	Laminate w/HPL Top	Laminate w/TFL Top
Linking Table Top 	25 13/16	25 13/16	15	28	4	MTV2525LTC	\$917		
	25 13/16	25 13/16	15	28	4	MTT2525LTC		\$872	\$847
· quarter round									
Linking Table Top 	22 1/4	15	15	18	2	MTV1522LTS	\$830		
	22 1/4	15	15	18	2	MTT1522LTS		\$789	\$766
· rectangle									
Linking Table Top 	22 1/4	22 1/4	15	22	3	MTV2230LTW	\$873		
	22 1/4	22 1/4	15	22	3	MTT2230LTW		\$830	\$806
· 30° wedge									
Linking Table Top 	22 1/4	22 1/4	15	22	3	MTV2222LTW	\$873		
	22 1/4	22 1/4	15	22	3	MTT2222LTW		\$830	\$806
· 22 1/2° wedge									

To Order, Specify:

- ① Model Number
- ② Wood Species - Cherry (CH1), Maple (MA1) or Walnut (WA1)
- ③ Wood Finish
- ④ Laminate Selection
- ⑤ Optional Wood Feet; add \$53 list and specify finish
- ⑥ Power Unit
 - Linking Drum Table - Node; specify with EC24 and order separately, see page 374.
- ⑦ Optional Coordinating Wood Grain Laminate Drum Table Top - no upcharge. Finishes with an asterisk (*) have a coordinating laminate available.

③ Wood Finish Options:

Cherry		Maple	
AUT Autumn*		ALE Ale*	
BRL Barley*		BUT Butterscotch	
BBN Bourbon*		CIN Cinnamon*	
BRG Brighton*		FLX Flax	
CLA Classic*		VEN Venetian*	
EAR Earthy			
LGC Legacy*			
PRL Praline*			
SAF Saffron*			
Walnut			
AUB Auburn*			
ESP Espresso			
MCH Mocha*			
NTO Night Owl*			
SIE Sienna*			
TOF Toffee*			
TRF Truffle*			

④ Laminate Options: (for linking table top)

AUT Autumn	GRH Graphite
ALB Alabaster	HGL High Line
BLO Blonde Echo	SHD Shadow
BBN Bourbon	SHE Shea
BZW Brazilwood	SLG Slate Grey
BBL Bridal Blanco	STU Studio Teak
BRG Brighton	TAU Taupe
DWH Designer White	VIN Vintage
DOV Dove Grey	WLH Walnut Heights

Specifications

Linking Drum Table

- Metal leg standard with 2 3/8" diameter leveling disc.
- Plywood construction with glue, dowel, and metal fasteners.
- Linking bracket included to attach to lounge.

Linking Table Top

- 1" thick top with wood rim or PVC edge on silver metal frame.
- Permanent bolt attachment through side of adjacent lounge unit.▲

Description	D	W	H	CTN WT	CU FT	① Model	List Price
Conical Base Pull-Up Table	22	22	26	48	7	MTVP22ROUN	\$1,123
	26	26	26	51	8	MTVP26ROUN	\$1,141
	30	30	26	52	9	MTVP30ROUN	\$1,163

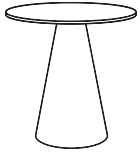

· round top

Conical Base Pull-Up Table	22	22	26	46	7	MTVP22TRI	\$1,123
	26	26	26	49	8	MTVP26TRI	\$1,141

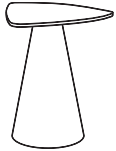

· triangle top

Conical Base Pull-Up Table	22	22	26	47	7	MTVP22SQCL	\$1,123
	26	26	26	50	8	MTVP26SQCL	\$1,141

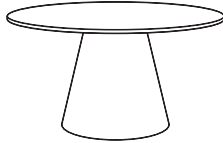

· squircle top

Description	D	W	H	CTN WT	CU FT	1 Model	List Price
	36	36	26	116	16	MTVF36ROUN	\$1,607
	42	42	26	127	17	MTVF42ROUN	\$1,661
	48	48	26	138	19	MTVF48ROUN	\$1,708
	54	54	26	152	21	MTVF54ROUN	\$1,770

- round top
- power unit available, see page 374

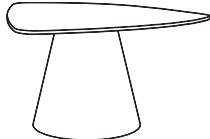
Description	D	W	H	CTN WT	CU FT	1 Model	List Price
	36	36	26	113	16	MTVF36TRI	\$1,627
	42	42	26	122	17	MTVF42TRI	\$1,670
	48	48	26	132	19	MTVF48TRI	\$1,708
	54	54	26	146	21	MTVF54TRI	\$1,770

- triangle top
- power unit available, see page 374

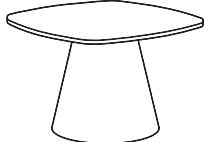
Description	D	W	H	CTN WT	CU FT	1 Model	List Price
	36	36	26	121	16	MTVF36SQCL	\$1,607
	42	42	26	134	17	MTVF42SQCL	\$1,661
	48	48	26	146	19	MTVF48SQCL	\$1,708
	54	54	26	162	21	MTVF54SQCL	\$1,770

- squircle top
- power unit available, see page 374

To Order, Specify:

- 1 Model Number
- 2 Top Material
 - A.) Veneer
 - 1.) Wood Species - Cherry (CH1), Maple (MA1), or Walnut (WA1) (see page 334)
 - 2.) Finish Color (see page 334)
 - B.) Laminate
 - 1.) Laminate Color (see page 334)
 - C.) Paint
 - 1.) Paint Color (see page 334)
- 3 Conical Base Color
- 4 Power Unit - Moire; specify with EC23 cut-out or Node; specify with EC24 cut-out. The EC23 and EC24 must be ordered separately, see page 374.

2 Top Options:

- A.) Top Wood Finish Options:
- | | |
|--------------|------------------|
| Cherry | Maple |
| AUT Autumn | ALE Ale |
| BRL Barley | BUT Butterscotch |
| BBN Bourbon | CIN Cinnamon |
| BRG Brighton | FLX Flax |
| CLA Classic | VEN Venetian |
| EAR Earthy | |
| LGC Legacy | Walnut |
| PRL Praline | AUB Auburn |
| SAF Saffron | ESP Espresso |
| | MCH Mocha |
| | NTO Night Owl |
| | SIE Sienna |
| | TOF Toffee |
| | TRF Truffle |
- B.) Top Laminate Color Options:
- | | |
|--------------------|--------------------|
| ALB Alabaster | MCH Mocha |
| AUB Auburn | NTO Night Owl |
| AUT Autumn | PRL Praline |
| BRL Barley | SAF Saffron |
| BLO Blonde Echo | SHD Shadow |
| BBN Bourbon | SHE Shea |
| BZW Brazilwood | SIE Sienna |
| BBL Bridal Blanco | SLG Slate Grey |
| BRG Brighton | STU Studio Teak |
| CIN Cinnamon | TAU Taupe |
| CLA Classic | TOF Toffee |
| DWH Designer White | TRF Truffle |
| DOV Dove Grey | VEN Venetian |
| GRH Graphite | VIN Vintage |
| HGL High Line | WLH Walnut Heights |
| LGC Legacy | |

- C.) Top Paint Color Options:
- | | |
|------------------|----------------------|
| BKD Backdrop | GRV Greek Villa |
| BFX Black Fox | NET Network Gray |
| BWH Bright White | NWH Nonchalant White |
| CGP Cargo Pants | STM Storm |
| CHT Chatroom | TRC Tricorn Black |
| FRR French Roast | |

3 Base Color Options:

- | | |
|----------------------------|-------------------------------|
| PAB Alabaster | CGR Graphite Coordinate |
| ALE Ale | GRV Greek Villa |
| AUB Auburn | GLF Gulf Stream |
| AUT Autumn | HTB Heartthrob |
| BRL Barley | CHL Highline Coordinate |
| BKD Backdrop | LGC Legacy |
| BFX Black Fox | MCH Mocha |
| CBE Blonde Echo Coordinate | NET Network Gray |
| BBN Bourbon | NTO Night Owl |
| CBZ Brazilwood Coordinate | NWH Nonchalant White |
| PBB Bridal Blanco | PAR Paradise |
| BRG Brighton | PRL Praline |
| BWH Bright White | QXP Quixotic Plum |
| BUT Butterscotch | RBZ Relic Bronze |
| CGP Cargo Pants | SAF Saffron |
| CHT Chatroom | SNB Sandbank |
| CLA Classic | SHD Shadow |
| CIN Cinnamon | SIE Sienna |
| DSY Daisy | PSG Slate Grey |
| DRG Daring | STM Storm |
| PDW Designer White | CST Studio Teak Coordinate |
| PDV Dove Grey | PTA Taupe |
| DYN Dynamo | TOF Toffee |
| EAR Earthy | TRC Tricorn Black |
| ENG Enigma | TRF Truffle |
| FLX Flax | VEN Venetian |
| FRR French Roast | CVI Vintage Coordinate |
| GBY Georgian Bay | CWH Walnut Heights Coordinate |

Description	D	W	H	CTN WT	CU FT	① Model	Veneer	Laminate w/HPL Top	Laminate w/TFL Top
Media Table	48	66	58	363	49	MTV4866-28MACB	\$5,457		
	48	66	58	363	49	MTT4866-28MACB		\$4,208	\$4,082

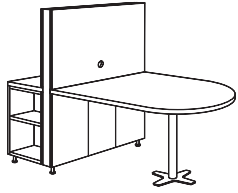

- bullet shape top
- 48" x 48" worksurface
- 28" h worksurface

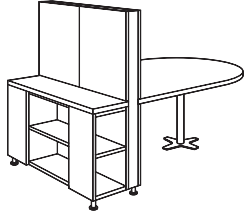

Media Table	48	72	58	381	52	MTV4872-28MACB	\$5,497		
	48	72	58	381	52	MTT4872-28MACB		\$4,255	\$4,128

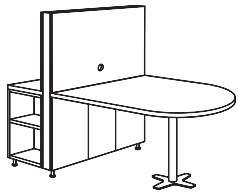

- bullet shape top
- 48" x 54" worksurface
- 28" h worksurface

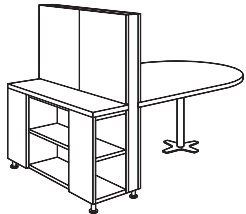

Description	D	W	H	CTN WT	CU FT	① Model	Veneer	Laminate w/HPL Top	Laminate w/TFL Top
Media Table	48	78	58	399	54	MTV4878-28MACB	\$5,539		
	48	78	58	399	54	MTT4878-28MACB		\$4,303	\$4,175

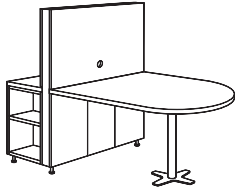

- bullet shape top
- 48" x 60" worksurface
- 28" h worksurface

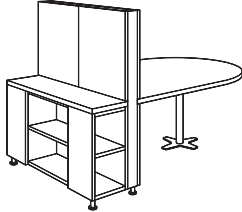

Media Table	48	84	58	417	57	MTV4884-28MACB	\$5,580		
	48	84	58	417	57	MTT4884-28MACB		\$4,352	\$4,221

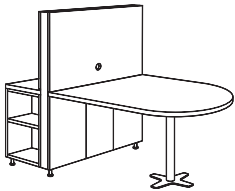

- bullet shape top
- 48" x 66" worksurface
- 28" h worksurface

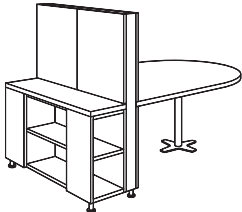

To Order, Specify:

- ① Model Number
- ② Wood Species - Cherry (CH1), Maple (MA1) or Walnut (WA1)
- ③ Wood Finish
- ④ Laminate Selection
- ⑤ Optional Wood Feet; add \$53 list and specify finish
- ⑥ Optional Power Unit
 - Media Table - Ellora; specify with EC25 and order separately, see page 374.
- ⑦ Optional DropShare Power Unit; specify with Drop12 or Drop14 and order separately, see page 374.
- ⑧ Optional Markerboard Back Panel; for 24" unit add \$189 list, for 48" unit add \$368
- ⑨ Deduct TV Bracket; subtract \$180 list
- ⑩ Optional Door Locks; add \$105 list
- ⑪ Optional Coordinating Wood Grain Laminate Table Top - no upcharge. Finishes with an asterisk (*) have a coordinating laminate available.

③ Wood Finish Options:

Cherry		Maple	
AUT Autumn*		ALE Ale*	
BRL Barley*		BUT Butterscotch	
BBN Bourbon*		CIN Cinnamon*	
BRG Brighton*		FLX Flax	
CLA Classic*		VEN Venetian*	
EAR Earthy			
LGC Legacy*			
PRL Praline*			
SAF Saffron*			
Walnut			
AUB Auburn*			
ESP Espresso			
MCH Mocha*			
NTO Night Owl*			
SIE Sienna*			
TOF Toffee*			
TRF Truffle*			

④ Laminate Options:

AUT Autumn	GRH Graphite
ALB Alabaster	HGL High Line
BLO Blonde Echo	SHD Shadow
BBN Bourbon	SHE Shea
BZW Brazilwood	SLG Slate Grey
BBL Bridal Blanco	STU Studio Teak
BRG Brighton	TAU Taupe
DWH Designer White	VIN Vintage
DOV Dove Grey	WLH Walnut Heights

Specifications

- Metal leg standard with 2 3/8" diameter leveling disc.
- 3" diameter metal support post with integrated leveling and X-base with neoprene pads.
- Plywood construction with glue, dowel, and metal fasteners.
- 1 3/8" thick worksurface with radiused corners and a wood rim or PVC edge.
- Grommet in media panel
- TV bracket included. Recommended TV size 42".
- Bookcase with side access and rear access. Each compartment has one adjustable shelf.
- Rear hinged doors for wire access.
- Removable lower panels for wire access.

Description	D	W	H	CTN WT	CU FT	① Model	Veneer	Laminate w/HPL Top	Laminate w/TFL Top
Media Table	48	66	58	358	49	MTV4866-28MACW	\$5,457		
	48	66	58	358	49	MTT4866-28MACW		\$4,208	\$4,082

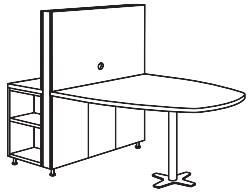

- wedge shape top
- 48" x 48" worksurface
- 28" h worksurface

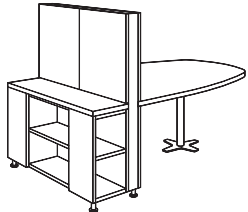

Media Table	48	72	58	374	51	MTV4872-28MACW	\$5,497		
	48	72	58	374	51	MTT4872-28MACW		\$4,255	\$4,128

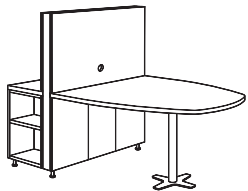

- wedge shape top
- 48" x 54" worksurface
- 28" h worksurface

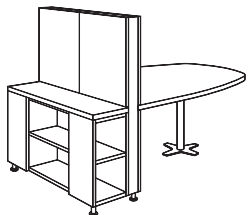

Media Table	48	78	58	391	53	MTV4878-28MACW	\$5,539		
	48	78	58	391	53	MTT4878-28MACW		\$4,303	\$4,175

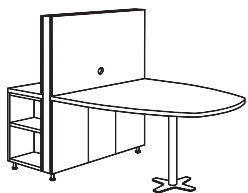

- wedge shape top
- 48" x 60" worksurface
- 28" h worksurface

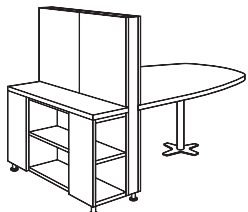

LOUNGE

Description	D	W	H	CTN WT	CU FT	① Model	Veneer	Laminate w/HPL Top	Laminate w/TFL Top
Media Table	48	84	58	407	56	MTV4884-28MACW	\$5,580		
	48	84	58	407	56	MTT4884-28MACW		\$4,352	\$4,221

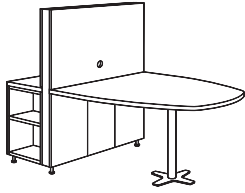

- wedge shape top
- 48" x 66" worksurface
- 28" h worksurface

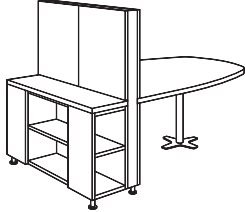

To Order, Specify:

- ① Model Number
- ② Wood Species - Cherry (CH1), Maple (MA1) or Walnut (WA1)
- ③ Wood Finish
- ④ Laminate Selection
- ⑤ Optional Wood Feet; add \$53 list and specify finish
- ⑥ Optional Power Unit
 - Media Table - Ellora; specify with EC25 and order separately, see page 374.
- ⑦ Optional DropShare Power Unit; specify with Drop12 or Drop14 and order separately, see page 374.
- ⑧ Optional Markerboard Back Panel; for 24" unit add \$189 list, for 48" unit add \$368
- ⑨ Deduct TV Bracket; subtract \$180 list
- ⑩ Optional Door Locks; add \$105 list
- ⑪ Optional Coordinating Wood Grain Laminate Table Top - no upcharge. Finishes with an asterisk (*) have a coordinating laminate available.

③ Wood Finish Options: ▲

Cherry		Maple	
AUT Autumn*		ALE Ale*	
BRL Barley*		BUT Butterscotch	
BBN Bourbon*		CIN Cinnamon*	
BRG Brighton*		FLX Flax	
CLA Classic*		VEN Venetian*	
EAR Earthy			
LGC Legacy*			
PRL Praline*			
SAF Saffron*			
Walnut			
AUB Auburn*			
ESP Espresso			
MCH Mocha*			
NTO Night Owl*			
SIE Sienna*			
TOF Toffee*			
TRF Truffle*			

④ Laminate Options:

AUT Autumn	GRH Graphite
ALB Alabaster	HGL High Line
BLO Blonde Echo	SHD Shadow
BBN Bourbon	SHE Shea
BZW Brazilwood	SLG Slate Grey
BBL Bridal Blanco	STU Studio Teak
BRG Brighton	TAU Taupe
DWH Designer White	VIN Vintage
DOV Dove Grey	WLH Walnut Heights

Specifications

- Metal leg standard with 2 3/8" diameter leveling disc.
- 3" diameter metal support post with integrated leveling and X-base with neoprene pads.
- Plywood construction with glue, dowel, and metal fasteners.
- 1 3/8" thick worksurface with radiused corners and a wood rim or PVC edge.
- Grommet in media panel
- TV bracket included. Recommended TV size 42".
- Bookcase with side access and rear access. Each compartment has one adjustable shelf.
- Rear hinged doors for wire access.
- Removable lower panels for wire access.

Description	D	W	H	CTN WT	CU FT	① Model	Veneer	Laminate w/HPL Top	Laminate w/TFL Top
Media Table	48	54	68	367	51	MTV4854-39MACB	\$5,497		
	48	54	68	367	51	MTT4854-39MACB		\$4,199	\$4,074

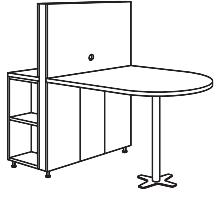

- bullet shape top
- 48" x 36" worksurface
- 39" h worksurface

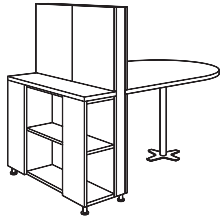

Media Table	48	60	68	385	54	MTV4860-39MACB	\$5,530		
	48	60	68	385	54	MTT4860-39MACB		\$4,239	\$4,112

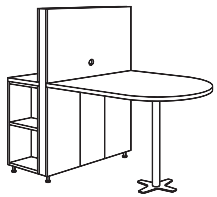

- bullet shape top
- 48" x 42" worksurface
- 39" h worksurface

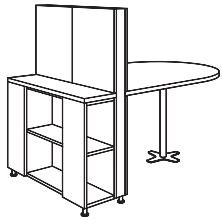

Media Table	48	66	68	403	56	MTV4866-39MACB	\$5,618		
	48	66	68	403	56	MTT4866-39MACB		\$4,335	\$4,206

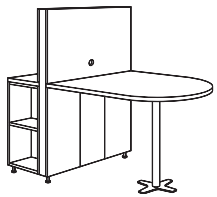

- bullet shape top
- 48" x 48" worksurface
- 39" h worksurface

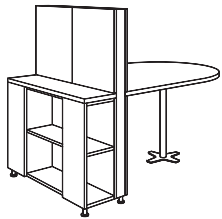

Media Table	48	72	68	421	59	MTV4872-39MACB	\$5,658		
	48	72	68	421	59	MTT4872-39MACB		\$4,381	\$4,250

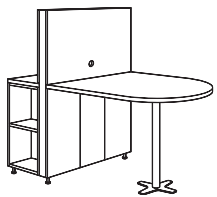

- bullet shape top
- 48" x 54" worksurface
- 39" h worksurface

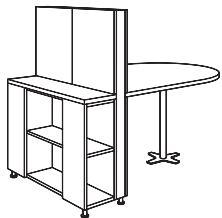

Description	D	W	H	CTN WT	CU FT	① Model	Veneer	Laminate w/HPL Top	Laminate w/TFL Top
Media Table	48	78	68	439	61	MTV4878-39MACB	\$5,700		
	48	78	68	439	61	MTT4878-39MACB		\$4,431	\$4,299

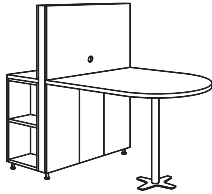

- bullet shape top
- 48" x 60" worksurface
- 39" h worksurface

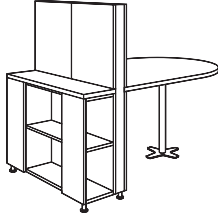

Media Table	48	84	68	457	64	MTV4884-39MACB	\$5,742		
	48	84	68	457	64	MTT4884-39MACB		\$4,479	\$4,345

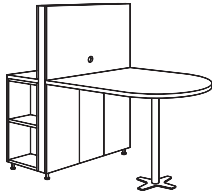

- bullet shape top
- 48" x 66" worksurface
- 39" h worksurface

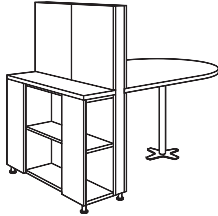

To Order, Specify:

- ① Model Number
- ② Wood Species - Cherry (CH1), Maple (MA1) or Walnut (WA1)
- ③ Wood Finish
- ④ Laminate Selection
- ⑤ Optional Wood Feet; add \$53 list and specify finish
- ⑥ Optional Power Unit
 - Media Table - Ellora; specify with EC25 and order separately, see page 374.
- ⑦ Optional DropShare Power Unit; specify with Drop12 or Drop14 and order separately, see page 374.
- ⑧ Optional Markerboard Back Panel; for 24" unit add \$189 list, for 48" unit add \$368
- ⑨ Deduct TV Bracket; subtract \$180 list
- ⑩ Optional Door Locks; add \$105 list
- ⑪ Optional Coordinating Wood Grain Laminate Table Top - no upcharge. Finishes with an asterisk (*) have a coordinating laminate available.

③ Wood Finish Options:

Cherry		Maple	
AUT	Autumn*	ALE	Ale*
BRL	Barley*	BUT	Butterscotch
BBN	Bourbon*	CIN	Cinnamon*
BRG	Brighton*	FLX	Flax
CLA	Classic*	VEN	Venetian*
EAR	Earthy		
LGC	Legacy*		
PRL	Praline*		
SAF	Saffron*		
Walnut			
AUB	Auburn*		
ESP	Espresso		
MCH	Mocha*		
NTO	Night Owl*		
SIE	Sienna*		
TOF	Toffee*		
TRF	Truffle*		

④ Laminate Options:

AUT	Autumn	GRH	Graphite
ALB	Alabaster	HGL	High Line
BLO	Blonde Echo	SHD	Shadow
BBN	Bourbon	SHE	Shea
BZW	Brazilwood	SLG	Slate Grey
BBL	Bridal Blanco	STU	Studio Teak
BRG	Brighton	TAU	Taupe
DWH	Designer White	VIN	Vintage
DOV	Dove Grey	WLH	Walnut Heights

Specifications

- Metal leg standard with 2 3/8" diameter leveling disc.
- 3" diameter metal support post with integrated leveling and X-base with neoprene pads.
- Plywood construction with glue, dowel, and metal fasteners.
- 1 3/8" thick worksurface with radiused corners and a wood rim or PVC edge.
- Grommet in media panel
- TV bracket included. Recommended TV size 42".
- Bookcase with side access and rear access. Each compartment has one adjustable shelf.
- Rear hinged doors for wire access.
- Removable lower panels for wire access.

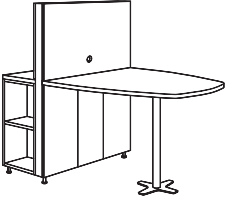
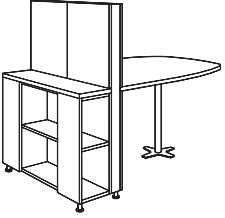
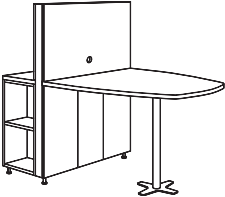
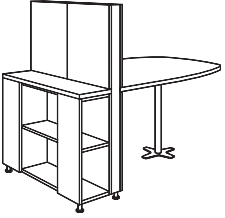
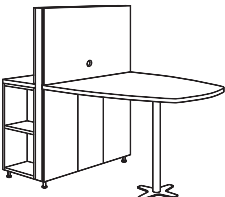
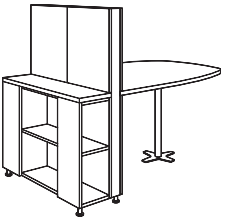
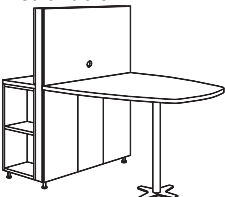
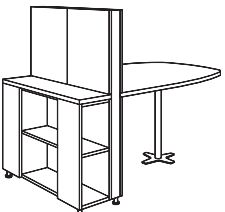
Description	D	W	H	CTN WT	CU FT	① Model	Veneer	Laminate w/HPL Top	Laminate w/TFL Top
Media Table   <ul style="list-style-type: none"> · wedge shape top · 48" x 36" worksurface · 39" h worksurface 	48	54	68	365	51	MTV4854-39MACW	\$5,497		
		48	54	68	365	51	MTT4854-39MACW		\$4,199
Media Table   <ul style="list-style-type: none"> · wedge shape top · 48" x 42" worksurface · 39" h worksurface 	48	60	68	381	53	MTV4860-39MACW	\$5,530		
		48	60	68	381	53	MTT4860-39MACW		\$4,239
Media Table   <ul style="list-style-type: none"> · wedge shape top · 48" x 48" worksurface · 39" h worksurface 	48	66	68	398	56	MTV4866-39MACW	\$5,618		
		48	66	68	398	56	MTT4866-39MACW		\$4,335
Media Table   <ul style="list-style-type: none"> · wedge shape top · 48" x 54" worksurface · 39" h worksurface 	48	72	68	414	58	MTV4872-39MACW	\$5,658		
		48	72	68	414	58	MTT4872-39MACW		\$4,381

LOUNGE

Description	D	W	H	CTN WT	CU FT	① Model	Veneer	Laminate w/HPL Top	Laminate w/TFL Top
Media Table	48	78	68	431	60	MTV4878-39MACW	\$5,700		
	48	78	68	431	60	MTT4878-39MACW		\$4,431	\$4,299

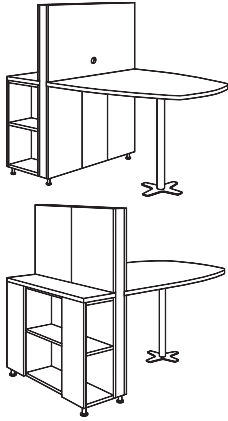

- wedge shape top
- 48" x 60" worksurface
- 39" h worksurface

Media Table	48	84	68	447	63	MTV4884-39MACW	\$5,742		
	48	84	68	447	63	MTT4884-39MACW		\$4,479	\$4,345

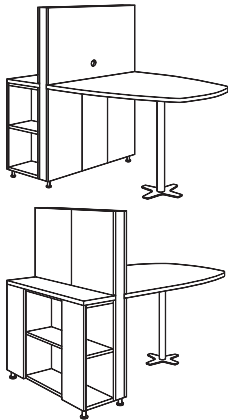

- wedge shape top
- 48" x 66" worksurface
- 39" h worksurface

To Order, Specify:

- ① Model Number
- ② Wood Species - Cherry (CH1), Maple (MA1) or Walnut (WA1)
- ③ Wood Finish
- ④ Laminate Selection
- ⑤ Optional Wood Feet; add \$53 list and specify finish
- ⑥ Optional Power Unit
 - Media Table - Ellora; specify with EC25 and order separately, see page 374.
- ⑦ Optional DropShare Power Unit; specify with Drop12 or Drop14 and order separately, see page 374.
- ⑧ Optional Markerboard Back Panel; for 24" unit add \$189 list, for 48" unit add \$368
- ⑨ Deduct TV Bracket; subtract \$180 list
- ⑩ Optional Door Locks; add \$105 list
- ⑪ Optional Coordinating Wood Grain Laminate Table Top - no upcharge. Finishes with an asterisk (*) have a coordinating laminate available.

③ Wood Finish Options:

Cherry		Maple	
AUT	Autumn*	ALE	Ale*
BRL	Barley*	BUT	Butterscotch
BBN	Bourbon*	CIN	Cinnamon*
BRG	Brighton*	FLX	Flax
CLA	Classic*	VEN	Venetian*
EAR	Earthy		
LGC	Legacy*		
PRL	Praline*		
SAF	Saffron*		
Walnut			
AUB	Auburn*		
ESP	Espresso		
MCH	Mocha*		
NTO	Night Owl*		
SIE	Sienna*		
TOF	Toffee*		
TRF	Truffle*		

④ Laminate Options:

AUT	Autumn	GRH	Graphite
ALB	Alabaster	HGL	High Line
BLO	Blonde Echo	SHD	Shadow
BBN	Bourbon	SHE	Shea
BZW	Brazilwood	SLG	Slate Grey
BBL	Bridal Blanco	STU	Studio Teak
BRG	Brighton	TAU	Taupe
DWH	Designer White	VIN	Vintage
DOV	Dove Grey	WLH	Walnut Heights

Specifications

- Metal leg standard with 2 3/8" diameter leveling disc.
- 3" diameter metal support post with integrated leveling and X-base with neoprene pads.
- Plywood construction with glue, dowel, and metal fasteners.
- 1 3/8" thick worksurface with radiused corners and a wood rim or PVC edge.
- Grommet in media panel
- TV bracket included. Recommended TV size 42".
- Bookcase with side access and rear access. Each compartment has one adjustable shelf.
- Rear hinged doors for wire access.
- Removable lower panels for wire access.

Description	D	W	H	CTN WT	CU FT	① Model	Veneer	Laminate w/HPL Top	Laminate w/TFL Top
Wall Dependent Media Table	48	54	58	217	20	MTV4854-28MAWB	\$4,038		
	48	54	58	217	20	MTT4854-28MAWB		\$3,358	\$3,259

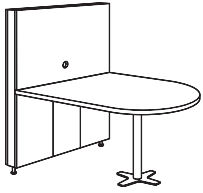

- bullet shape top
- 48" x 48" worksurface
- 28" h worksurface

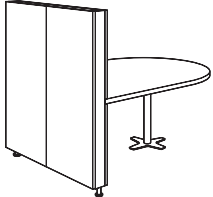

Wall Dependent Media Table	48	60	58	235	23	MTV4860-28MAWB	\$4,078		
	48	60	58	235	23	MTT4860-28MAWB		\$3,406	\$3,304

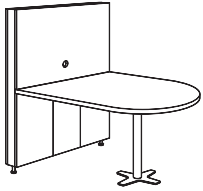

- bullet shape top
- 48" x 54" worksurface
- 28" h worksurface

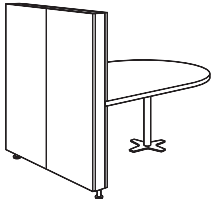

Wall Dependent Media Table	48	66	58	253	25	MTV4866-28MAWB	\$4,095		
	48	66	58	253	25	MTT4866-28MAWB		\$3,455	\$3,352

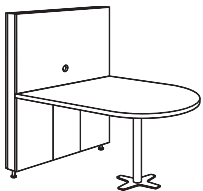

- bullet shape top
- 48" x 60" worksurface
- 28" h worksurface

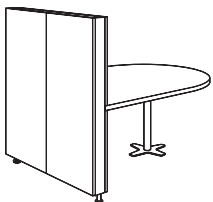

Description	D	W	H	CTN WT	CU FT	① Model	Veneer	Laminate w/HPL Top	Laminate w/TFL Top
Wall Dependent Media Table	48	72	58	271	28	MTV4872-28MAWB	\$4,161		
	48	72	58	271	28	MTT4872-28MAWB		\$3,503	\$3,398

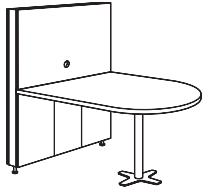

- bullet shape top
- 48" x 66" worksurface
- 28" h worksurface

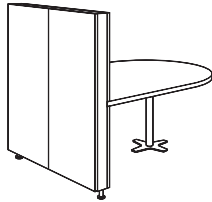

To Order, Specify:

- ① Model Number
- ② Wood Species - Cherry (CH1), Maple (MA1) or Walnut (WA1)
- ③ Wood Finish
- ④ Laminate Selection
- ⑤ Optional Wood Feet; add \$53 list and specify finish
- ⑥ Optional Power Unit
 - Media Table - Ellora; specify with EC25 and order separately, see page 374.
- ⑦ Optional DropShare Power Unit; specify with Drop12 or Drop14 and order separately, see page 374.
- ⑧ Deduct TV Bracket; subtract \$180 list
- ⑨ Optional Door Locks; add \$105 list
- ⑩ Optional Coordinating Wood Grain Laminate Table Top - no upcharge. Finishes with an asterisk (*) have a coordinating laminate available.

③ Wood Finish Options:

Cherry		Maple	
AUT Autumn*		ALE Ale*	
BRL Barley*		BUT Butterscotch	
BBN Bourbon*		CIN Cinnamon*	
BRG Brighton*		FLX Flax	
CLA Classic*		VEN Venetian*	
EAR Earthy			
LGC Legacy*			
PRL Praline*			
SAF Saffron*			
Walnut			
AUB Auburn*			
ESP Espresso			
MCH Mocha*			
NTO Night Owl*			
SIE Sienna*			
TOF Toffee*			
TRF Truffle*			

④ Laminate Options:

AUT Autumn	GRH Graphite
ALB Alabaster	HGL High Line
BLO Blonde Echo	SHD Shadow
BBN Bourbon	SHE Shea
BZW Brazilwood	SLG Slate Grey
BBL Bridal Blanco	STU Studio Teak
BRG Brighton	TAU Taupe
DWH Designer White	VIN Vintage
DOV Dove Grey	WLH Walnut Heights

Specifications

- Metal leg standard with 2 3/8" diameter leveling disc.
- 3" diameter metal support post with integrated leveling and X-base with neoprene pads.
- Plywood construction with glue, dowel, and metal fasteners.
- 1 3/16" thick worksurface with radiused corners and a wood rim or PVC edge.
- Grommet in media panel
- TV bracket included. Recommended TV size 42".
- Rear hinged doors for wire access.
- Removable lower panels for wire access.
- Intended for use against a wall. Does not attach to the wall.

Description	D	W	H	CTN WT	CU FT	① Model	Veneer	Laminate w/HPL Top	Laminate w/TFL Top
Wall Dependent Media Table	48	54	58	212	20	MTV4854-28MAWW	\$4,038		
	48	54	58	212	20	MTT4854-28MAWW		\$3,358	\$3,259

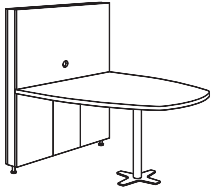

- wedge shape top
- 48" x 48" worksurface
- 28" h worksurface

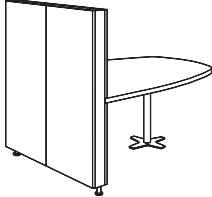

Wall Dependent Media Table	48	60	58	228	22	MTV4860-28MAWW	\$4,078		
	48	60	58	228	22	MTT4860-28MAWW		\$3,406	\$3,304

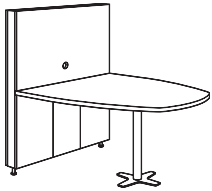

- wedge shape top
- 48" x 54" worksurface
- 28" h worksurface

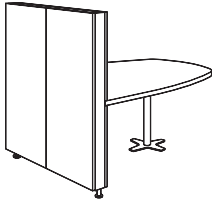

Wall Dependent Media Table	48	66	58	245	24	MTV4866-28MAWW	\$4,095		
	48	66	58	245	24	MTT4866-28MAWW		\$3,455	\$3,352

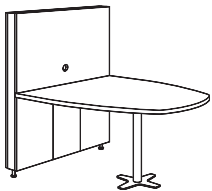

- wedge shape top
- 48" x 60" worksurface
- 28" h worksurface

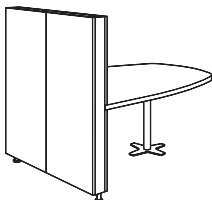

LOUNGE

Description	D	W	H	CTN WT	CU FT	① Model	Veneer	Laminate w/HPL Top	Laminate w/TFL Top
Wall Dependent Media Table	48	72	58	261	27	MTV4872-28MAWW	\$4,161		
	48	72	58	261	27	MTT4872-28MAWW		\$3,503	\$3,398

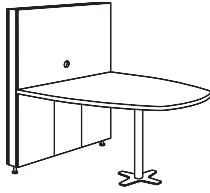

- wedge shape top
- 48" x 66" worksurface
- 28" h worksurface

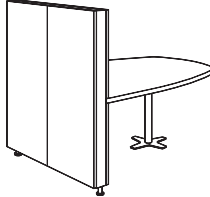

To Order, Specify:

- ① Model Number
- ② Wood Species - Cherry (CH1), Maple (MA1) or Walnut (WA1)
- ③ Wood Finish
- ④ Laminate Selection
- ⑤ Optional Wood Feet; add \$53 list and specify finish
- ⑥ Optional Power Unit
 - Media Table - Ellora; specify with EC25 and order separately, see page 374.
- ⑦ Optional DropShare Power Unit; specify with Drop12 or Drop14 and order separately, see page 374.
- ⑧ Deduct TV Bracket; subtract \$180 list
- ⑨ Optional Door Locks; add \$105 list
- ⑩ Optional Coordinating Wood Grain Laminate Table Top - no upcharge. Finishes with an asterisk (*) have a coordinating laminate available.

③ Wood Finish Options:

Cherry		Maple	
AUT Autumn*		ALE Ale*	
BRL Barley*		BUT Butterscotch	
BBN Bourbon*		CIN Cinnamon*	
BRG Brighton*		FLX Flax	
CLA Classic*		VEN Venetian*	
EAR Earthy			
LGC Legacy*			
PRL Praline*			
SAF Saffron*			
Walnut			
AUB Auburn*			
ESP Espresso			
MCH Mocha*			
NTO Night Owl*			
SIE Sienna*			
TOF Toffee*			
TRF Truffle*			

④ Laminate Options:

AUT Autumn	GRH Graphite
ALB Alabaster	HGL High Line
BLO Blonde Echo	SHD Shadow
BBN Bourbon	SHE Shea
BZW Brazilwood	SLG Slate Grey
BBL Bridal Blanco	STU Studio Teak
BRG Brighton	TAU Taupe
DWH Designer White	VIN Vintage
DOV Dove Grey	WLH Walnut Heights

Specifications

- Metal leg standard with 2 3/8" diameter leveling disc.
- 3" diameter metal support post with integrated leveling and X-base with neoprene pads.
- Plywood construction with glue, dowel, and metal fasteners.
- 1 3/8" thick worksurface with radiused corners and a wood rim or PVC edge.
- Grommet in media panel
- TV bracket included. Recommended TV size 42".
- Rear hinged doors for wire access.
- Removable lower panels for wire access.
- Intended for use against a wall. Does not attach to the wall.

Description	D	W	H	CTN WT	CU FT	① Model	Veneer	Laminate w/HPL Top	Laminate w/TFL Top
Wall Dependent Media Table	48	42	68	204	17	MTV4842-39MAWB	\$4,073		
	48	42	68	204	17	MTT4842-39MAWB		\$3,356	\$3,257

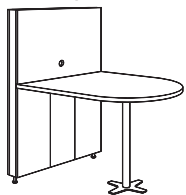

- bullet shape top
- 48" x 36" worksurface
- 39" h worksurface

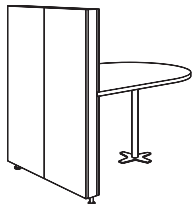

Wall Dependent Media Table	48	48	68	222	20	MTV4848-39MAWB	\$4,106		
	48	48	68	222	20	MTT4848-39MAWB		\$3,396	\$3,294

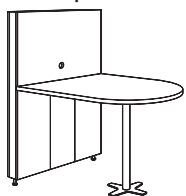

- bullet shape top
- 48" x 42" worksurface
- 39" h worksurface

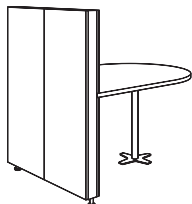

Wall Dependent Media Table	48	54	68	240	22	MTV4854-39MAWB	\$4,194		
	48	54	68	240	22	MTT4854-39MAWB		\$3,492	\$3,388

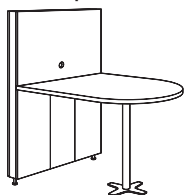

- bullet shape top
- 48" x 48" worksurface
- 39" h worksurface

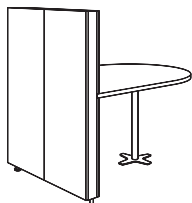

Wall Dependent Media Table	48	60	68	258	25	MTV4860-39MAWB	\$4,234		
	48	60	68	258	25	MTT4860-39MAWB		\$3,539	\$3,433

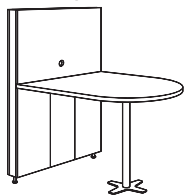

- bullet shape top
- 48" x 54" worksurface
- 39" h worksurface

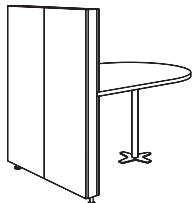

LOUNGE

Description	D	W	H	CTN WT	CU FT	① Model	Veneer	Laminate w/HPL Top	Laminate w/TFL Top
Wall Dependent Media Table	48	66	68	276	27	MTV4866-39MAWB	\$4,275		
	48	66	68	276	27	MTT4866-39MAWB		\$3,587	\$3,480

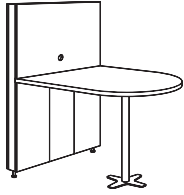

- bullet shape top
- 48" x 60" worksurface
- 39" h worksurface

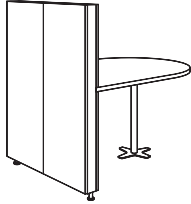

Wall Dependent Media Table	48	72	68	294	30	MTV4872-39MAWB	\$4,316		
	48	72	68	294	30	MTT4872-39MAWB		\$3,635	\$3,526

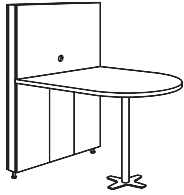

- bullet shape top
- 48" x 66" worksurface
- 39" worksurface

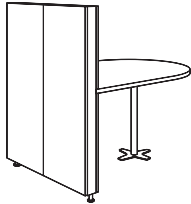

To Order, Specify:

- ① Model Number
- ② Wood Species - Cherry (CH1), Maple (MA1) or Walnut (WA1)
- ③ Wood Finish
- ④ Laminate Selection
- ⑤ Optional Wood Feet; add \$53 list and specify finish
- ⑥ Optional Power Unit
 - Media Table - Ellora; specify with EC25 and order separately, see page 374.
- ⑦ Optional DropShare Power Unit; specify with Drop12 or Drop14 and order separately, see page 374.
- ⑧ Deduct TV Bracket; subtract \$180 list
- ⑨ Optional Door Locks; add \$105 list
- ⑩ Optional Coordinating Wood Grain Laminate Table Top - no upcharge. Finishes with an asterisk (*) have a coordinating laminate available.

③ Wood Finish Options:

Cherry		Maple	
AUT Autumn*		ALE Ale*	
BRL Barley*		BUT Butterscotch	
BBN Bourbon*		CIN Cinnamon*	
BRG Brighton*		FLX Flax	
CLA Classic*		VEN Venetian*	
EAR Earthy			
LGC Legacy*			
PRL Praline*			
SAF Saffron*			
Walnut			
AUB Auburn*			
ESP Espresso*			
MCH Mocha			
NTO Night Owl*			
SIE Sienna*			
TOF Toffee*			
TRF Truffle*			

④ Laminate Options:

AUT Autumn	GRH Graphite
ALB Alabaster	HGL High Line
BLO Blonde Echo	SHD Shadow
BBN Bourbon	SHE Shea
BZW Brazilwood	SLG Slate Grey
BBL Bridal Blanco	STU Studio Teak
BRG Brighton	TAU Taupe
DWH Designer White	VIN Vintage
DOV Dove Grey	WLH Walnut Heights

Specifications

- Metal leg standard with 2 3/8" diameter leveling disc.
- 3" diameter metal support post with integrated leveling and X-base with neoprene pads.
- Plywood construction with glue, dowel, and metal fasteners.
- 1 3/8" thick worksurface with radiused corners and a wood rim or PVC edge.
- Grommet in media panel
- TV bracket included. Recommended TV size 42".
- Rear hinged doors for wire access.
- Removable lower panels for wire access.
- Intended for use against a wall. Does not attach to the wall.

Description	D	W	H	CTN WT	CU FT	① Model	Veneer	Laminate w/HPL Top	Laminate w/TFL Top
Wall Dependent Media Table	48	42	68	202	17	MTV4842-39MAWW	\$4,073		
	48	42	68	202	17	MTT4842-39MAWW		\$3,356	\$3,257



- wedge shape top
- 48" x 36" worksurface
- 39" h worksurface

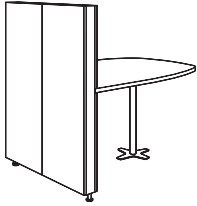

Wall Dependent Media Table	48	48	68	218	19	MTV4848-39MAWW	\$4,106		
	48	48	68	218	19	MTT4848-39MAWW		\$3,396	\$3,294



- wedge shape top
- 48" x 42" worksurface
- 39" h worksurface

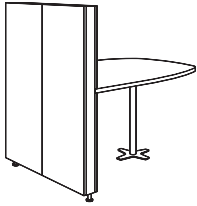

Wall Dependent Media Table	48	54	68	235	22	MTV4854-39MAWW	\$4,194		
	48	54	68	235	22	MTT4854-39MAWW		\$3,492	\$3,388



- wedge shape top
- 48" x 48" worksurface
- 39" h worksurface

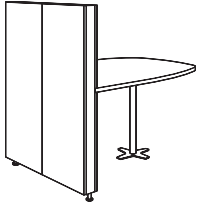

Wall Dependent Media Table	48	60	68	251	24	MTV4860-39MAWW	\$4,234		
	48	60	68	251	24	MTT4860-39MAWW		\$3,539	\$3,433



- wedge shape top
- 48" x 54" worksurface
- 39" h worksurface

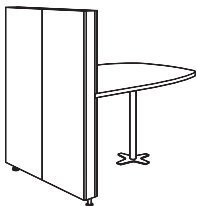

LOUNGE

Description	D	W	H	CTN WT	CU FT	① Model	Veneer	Laminate w/HPL Top	Laminate w/TFL Top
Wall Dependent Media Table	48	66	68	268	26	MTV4866-39MAWW	\$4,275		
	48	66	68	268	26	MTT4866-39MAWW		\$3,587	\$3,480



- wedge shape top
- 48" x 60" worksurface
- 39" h worksurface

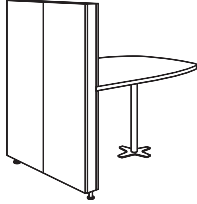

Wall Dependent Media Table	48	72	68	284	29	MTV4872-39MAWW	\$4,316		
	48	72	68	284	29	MTT4872-39MAWW		\$3,635	\$3,526



- wedge shape top
- 48" x 66" worksurface
- 39" h worksurface

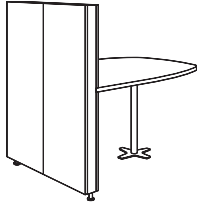

To Order, Specify:

- ① Model Number
- ② Wood Species - Cherry (CH1), Maple (MA1) or Walnut (WA1)
- ③ Wood Finish
- ④ Laminate Selection
- ⑤ Optional Wood Feet; add \$53 list and specify finish
- ⑥ Optional Power Unit
 - Media Table - Ellora; specify with EC25 and order separately, see page 374.
- ⑦ Optional DropShare Power Unit; specify with Drop12 or Drop14 and order separately, see page 374.
- ⑧ Deduct TV Bracket; subtract \$180 list
- ⑨ Optional Door Locks; add \$105 list
- ⑩ Optional Coordinating Wood Grain Laminate Table Top - no upcharge. Finishes with an asterisk (*) have a coordinating laminate available.

③ Wood Finish Options:

Cherry		Maple	
AUT	Autumn*	ALE	Ale*
BRL	Barley*	BUT	Butterscotch
BBN	Bourbon*	CIN	Cinnamon*
BRG	Brighton*	FLX	Flax
CLA	Classic*	VEN	Venetian*
EAR	Earthy		
LGC	Legacy*		
PRL	Praline*		
SAF	Saffron*		
Walnut			
AUB	Auburn*		
ESP	Espresso		
MCH	Mocha*		
NTO	Night Owl*		
SIE	Sienna*		
TOF	Toffee*		
TRF	Truffle*		

④ Laminate Options:

AUT	Autumn	GRH	Graphite
ALB	Alabaster	HGL	High Line
BLO	Blonde Echo	SHD	Shadow
BBN	Bourbon	SHE	Shea
BZW	Brazilwood	SLG	Slate Grey
BBL	Bridal Blanco	STU	Studio Teak
BRG	Brighton	TAU	Taupe
DWH	Designer White	VIN	Vintage
DOV	Dove Grey	WLH	Walnut Heights

Specifications

- Metal leg standard with 2 3/8" diameter leveling disc.
- 3" diameter metal support post with integrated leveling and X-base with neoprene pads.
- Plywood construction with glue, dowel, and metal fasteners.
- 1 3/8" thick worksurface with radiused corners and a wood rim or PVC edge.
- Grommet in media panel
- TV bracket included. Recommended TV size 42".
- Rear hinged doors for wire access.
- Removable lower panels for wire access.
- Intended for use against a wall. Does not attach to the wall.

Description	D	W	H	CTN WT	CU FT	① Model	Veneer	Laminate w/HPL Top	Laminate w/TFL Top
Media Credenza	18	48	58	280	35	MTV1848MCW	\$3,883		
	18	48	58	280	35	MTT1848MCW		\$2,856	\$2,771

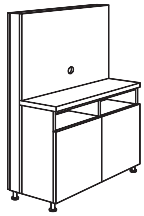

- 13" x 48" top surface
- 2 door cabinet

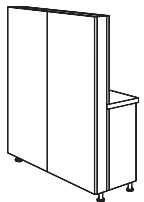

							Veneer	Laminate
Bookcase Storage	18	24	58	176	19	MTV1824-58SDR	\$1,553	
	18	24	58	176	19	MTV1824-58SDL	\$1,553	
	18	24	58	176	19	MTT1824-58SDR		\$1,073
	18	24	58	176	19	MTT1824-58SDL		\$1,073

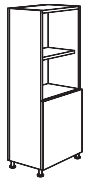

- door hinge left or right

Bookcase Storage	18	48	58	227	35	MTV1848-58SDC	\$1,700	
	18	48	58	227	35	MTT1848-58SDC		\$1,211

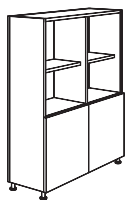

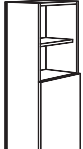
Description	D	W	H	CTN WT	CU FT	① Model	Veneer	Laminate
	18	24	68	199	22	MTV1824-68SDR	\$1,612	
	18	24	68	199	22	MTV1824-68SDL	\$1,612	
	18	24	68	199	22	MTT1824-68SDR		\$1,121
	18	24	68	199	22	MTT1824-68SDL		\$1,121

· door hinge left or right

Bookcase Storage	18	48	68	268	41	MTV1848-68SDC	\$1,864	
	18	48	68	268	41	MTT1848-68SDC		\$1,340

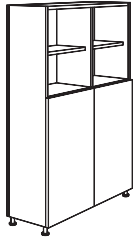

To Order, Specify:

- ① Model Number
- ② Wood Species - Cherry (CH1), Maple (MA1) or Walnut (WA1)
- ③ Wood Finish
- ④ Laminate Selection
- ⑤ Optional Wood Feet; add \$53 list and specify finish
- ⑥ Optional Power Unit
 - Media Credenza - Ellora; specify with EC25 and order separately, see page 374.
- ⑦ Optional DropShare Power Unit; specify with Drop12 or Drop14 and order separately, see page 374.
- ⑧ Optional Markerboard Back Panel; for 24" unit add \$189 list, for 48" unit add \$368
- ⑨ Deduct TV Bracket; subtract \$180 list
- ⑩ Optional Door Locks; add \$105 list
- ⑪ Optional Coordinating Wood Grain Laminate Table Top - no upcharge. Finishes with an asterisk (*) have a coordinating laminate available.

③ Wood Finish Options: ▲

Cherry		Maple	
AUT	Autumn*	ALE	Ale*
BRL	Barley*	BUT	Butterscotch
BBN	Bourbon*	CIN	Cinnamon*
BRG	Brighton*	FLX	Flax
CLA	Classic*	VEN	Venetian*
EAR	Earthy		
LGC	Legacy*		
PRL	Praline*		
SAF	Saffron*		
Walnut			
AUB	Auburn*		
ESP	Espresso		
MCH	Mocha*		
NTO	Night Owl*		
SIE	Sienna*		
TOF	Toffee*		
TRF	Truffle*		

④ Laminate Options:

AUT	Autumn	GRH	Graphite
ALB	Alabaster	HGL	High Line
BLO	Blonde Echo	SHD	Shadow
BBN	Bourbon	SHE	Shea
BZW	Brazilwood	SLG	Slate Grey
BBL	Bridal Blanco	STU	Studio Teak
BRG	Brighton	TAU	Taupe
DWH	Designer White	VIN	Vintage
DOV	Dove Grey	WLH	Walnut Heights

Specifications

Media Credenza

- Metal leg standard with 2 3/8" diameter leveling disc.
- Plywood construction with glue, dowel, and metal fasteners.
- Grommet in media panel
- TV bracket included. Recommended TV size 42".
- Open shelf with hinged door compartment below.
- Rear hinged doors for wire access.

Bookcase Storage

- Metal leg standard with 2 3/8" diameter leveling disc.
- Plywood construction with glue, dowel, and metal fasteners.
- Open shelf with hinged door compartment below.
- Adjustable shelves.

Description	D	W	H	CTN WT	CU FT	① Model	List Price
Moire Power Unit	3 3/8	3 3/8	2	5	1	EC23	\$461



- used in Conical Work Tables
- 3 power & 1 Dual USB, 72" cord
- color: black or white

Node Power Unit	3 3/8	3 3/8	3/8	5	1	EC24	\$382
------------------------	-------	-------	-----	---	---	-------------	--------------



- used in Linking Drum Tables
- 1 power & 1 Dual USB, 72" cord
- color: black or white

Ellora Power Unit	5 1/2	8 1/2	3 1/2	5	1	EC25	\$695
--------------------------	-------	-------	-------	---	---	-------------	--------------

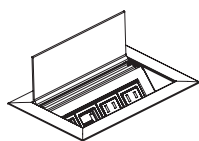

- used in Media Table or Media Credenza
- 2 power, 1 Dual USB & 1 data receptacle, 72" power cord
- wire pass-through
- anodized aluminum

DropShare	5 1/2	8 1/2	3 1/2	5	3	DROP12	\$4,548
------------------	-------	-------	-------	---	---	---------------	----------------

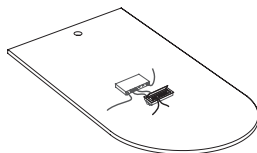

- used in Media Tables
- mounts in pre-determined standard location
- single sided unit with (2) receptacles and (2) Drop Share cords
- cord extends 48" from grommet in worksurface
- 6' power cord for receptacles
- control module mounts under worksurface
- module includes transformer with 6' power cord and (1) HDMI output for connection to monitor
- HDMI cable not included
- silver finish

DropShare	5 1/2	11 1/2	3 1/2	5	3	DROP14	\$6,286
------------------	-------	--------	-------	---	---	---------------	----------------

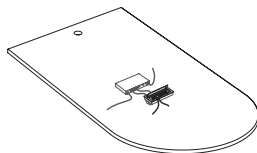

- used in Media Tables
- mounts in pre-determined standard location
- single sided unit with (2) receptacles and (4) Drop Share cords
- cord extends 48" from grommet in worksurface
- 6' power cord for receptacles
- control module mounts under worksurface
- module includes transformer with 6' power cord and (1) HDMI output for connection to monitor
- HDMI cable not included
- silver finish

To Order, Specify:

- ① Model Number

LOUNGE

Olympian Lounge Order Check List:



- Specify:**
- 1. Model Number
 - 2. Wood Species - Maple (M)
 - 3. Wood Finish
 - 4. Metal Color - Black Sandtex (BSX) or Stardust Silver (STS)
 - 5. Fabric Selection - vendor, pattern and color
 - 6. Optional Casters - \$92 list
 - 7. Optional Tablet Arm - add \$491 list; indicate left (TBL) or right (TBR)
 - 8. Optional Rubber Cushion Nylon Glides - no upcharge

Example:

OL7601U | M | AUB | MOMENTUM | VOX | MYSTIC
 (model #) | (wood species) | (finish) | (fabric vendor) | (pattern name) | (pattern color)

1. Model Number

- Special application instructions (e.g., all stripes will be applied front to back unless specified otherwise)
- Customer and purchase order number

2. Wood Species - Maple (M)

3. Wood Finish Options:

ALE Ale	FLX Flax
AUB Auburn	LGC Legacy
AUT Autumn	MCH Mocha
BRL Barley	NTO Night Owl
BBN Bourbon	PRL Praline
BRG Brighton	SAF Saffron
BUT Butterscotch	SIE Sienna
CIN Cinnamon	TOF Toffee
CLA Classic	TRF Truffle
EAR Earthy	VEN Venetian
ESP Espresso	

4. Metal Color - Black Sandtex (BSX) or Stardust Silver (STS)

5. Fabric Selection - Please supply the following:

- Fabric vendor
- Pattern name
- Pattern color

When specifying contrasting upholstery, indicate clearly which upholstery is to be applied to the seat, back and arms. Use higher grade pricing.

- Indicate direction of fabric - Railroaded or Up the Roll
- Please provide illustration, if available

All COM orders must include the following:

- Vendor's name, pattern name and color
- Sample of the fabric attached to order
- Model numbers of items for fabric application

Ship prepaid COM material to:
 JSI
 Attn: COM Dept
 932 Mill Street
 Jasper, IN 47546

Application of fabric:
 Railroaded Up the Roll

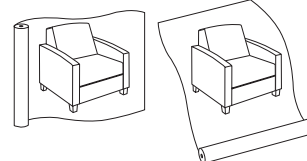

All COM orders will ship at standard lead time from receipt of COM except for orders requiring special custom matched finishes.

6. Optional Casters - \$92 list

7. Tablet Arm -

Tablet arm designated right (TBR) or left (TBL) as seated in chair - add \$491 list

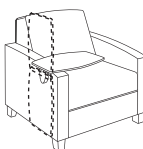

8. Optional Rubber Cushion Nylon Glides - no upcharge

LOUNGE

FREESTANDING

Description	Model	Specifications			List Price Per Grade	
Single Seat 	OL7601U · optional casters, add \$92 list	Dimensions	D	W	H	COM \$1,307
		Overall	31	31	34	A \$1,355
		Seat	21 ½	21 ½	18 ¼	B \$1,451
		Arm			25	COL/C \$1,619
		Upholstery	Shipping			D \$1,833
		COM Ydg	5 ½	Ctn Wt	70	E \$2,048
		COL Sq Ft	127	Cu Ft	30	F \$2,275
						G \$2,597
						H \$2,942
						I \$3,479
				J \$4,124		
				L1 \$3,092		
				L2 \$3,543		

Description	Model	Specifications			List Price Per Grade	
Single Seat with Wood Cap Arm 	OL7601W · optional casters, add \$92 list	Dimensions	D	W	H	COM \$1,439
		Overall	31	31	34	A \$1,487
		Seat	21 ½	21 ½	18 ¼	B \$1,583
		Arm			25 ½	COL/C \$1,751
		Upholstery	Shipping			D \$1,965
		COM Ydg	5 ½	Ctn Wt	74	E \$2,180
		COL Sq Ft	127	Cu Ft	30	F \$2,407
						G \$2,729
						H \$3,074
						I \$3,611
				J \$4,256		
				L1 \$3,224		
				L2 \$3,675		

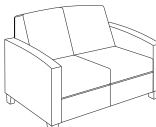
Description	Model	Specifications			List Price Per Grade	
Two Seat 	OL7602U	Dimensions	D	W	H	COM \$1,709
		Overall	31	49	34	A \$1,775
		Seat	21 ½	39 ½	18 ¼	B \$1,905
		Arm			25	COL/C \$2,133
		Upholstery	Shipping			D \$2,426
		COM Ydg	7 ½	Ctn Wt	92	E \$2,720
		COL Sq Ft	173	Cu Ft	46	F \$3,029
						G \$3,469
						H \$3,938
						I \$4,671
				J \$5,551		
				L1 \$4,143		
				L2 \$4,759		

To Order, Specify:

- Model Number
- Wood Species - Maple (M)
- Wood Finish
- Fabric Selection - vendor, pattern and color
- Optional Casters - add \$92 list
- Optional Tablet Arm - add \$491 list; indicate left (TBL) or right (TBR)
 - Tilt and Stow Tablet Arm Illustration 10"D x 16"W Surface
- Optional Rubber Cushion Nylon Glides - no upcharge



Wood Finish Options:

- | | |
|------------------|---------------|
| ALE Ale | FLX Flax |
| AUB Auburn | LGC Legacy |
| AUT Autumn | MCH Mocha |
| BRL Barley | NTO Night Owl |
| BBN Bourbon | PRL Praline |
| BRG Brighton | SAF Saffron |
| BUT Butterscotch | SIE Sienna |
| CIN Cinnamon | TOF Toffee |
| CLA Classic | TRF Truffle |
| EAR Earthy | VEN Venetian |
| ESP Espresso | |



- See a selection of graded in fabric manufacturers and patterns on pages 12-20. Contact Customer Service for additional fabric options.

Specifications

- 3 ½" tall solid maple leg.
- Seat has synthetic sheet webbing with cross strap reinforcement, 6" polyurethane foam and fixed cushion.
- Back has 3 ½" polyurethane foam.
- Arms have ½" polyurethane foam.
- Mortise and tenon construction with corner blocks, glue and screws.
- Wood caps are ¾" thick maple veneer.
- Standard with rubber cushion metal glides.

When ordering Quickship products, place a "Q" in front of model number.
 Example: QGT4901D

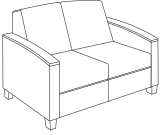
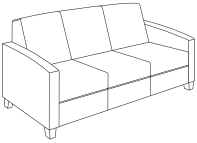
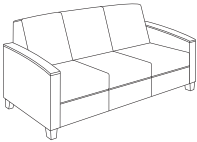
NOW!
 Need it.
 JSI Quickship

Description	① Model	Specifications				List Price Per Grade
Two Seat with Wood Cap Arm 	OL7602W	Dimensions				COM \$1,842
			D	W	H	A \$1,908
		Overall	31	49	34	B \$2,039
		Seat	21 ½	39 ½	18 ¼	COL/C \$2,266
		Arm			25 ½	D \$2,559
		Upholstery		Shipping		E \$2,853
		COM Ydg	7 ½	Ctn Wt	96	F \$3,162
		COL Sq Ft	173	Cu Ft	46	G \$3,602
						H \$4,071
						I \$4,804
				J \$5,684		
				L1 \$4,276		
				L2 \$4,892		
Three Seat 	OL7603U	Dimensions				COM \$2,483
			D	W	H	A \$2,566
		Overall	31	69	34	B \$2,732
		Seat	21 ½	59 ½	18 ¼	COL/C \$3,020
		Arm			25	D \$3,391
		Upholstery		Shipping		E \$3,763
		COM Ydg	9 ½	Ctn Wt	115	F \$4,154
		COL Sq Ft	219	Cu Ft	62	G \$4,712
						H \$5,306
						I \$6,234
				J \$7,348		
				L1 \$5,567		
				L2 \$6,346		
Three Seat with Wood Cap Arm 	OL7603W	Dimensions				COM \$2,617
			D	W	H	A \$2,700
		Overall	31	69	34	B \$2,866
		Seat	21 ½	59 ½	18 ¼	COL/C \$3,155
		Arm			25 ½	D \$3,525
		Upholstery		Shipping		E \$3,897
		COM Ydg	9 ½	Ctn Wt	119	F \$4,289
		COL Sq Ft	219	Cu Ft	62	G \$4,846
						H \$5,441
						I \$6,369
				J \$7,483		
				L1 \$5,701		
				L2 \$6,480		
22" x 22" Ottoman 	OL7604 · optional casters, add \$92 list · carton weight based on two per box	Dimensions				COM \$744
			D	W	H	A \$766
		Overall	22	22	16 ½	B \$810
		Seat				COL/C \$886
		Arm				D \$983
		Upholstery		Shipping		E \$1,081
		COM Ydg	2 ½	Ctn Wt	65	F \$1,184
		COL Sq Ft	50	Cu Ft	20	G \$1,331
						H \$1,487
						I \$1,732
				J \$2,025		
				L1 \$1,438		
				L2 \$1,614		

Description	Model	Specifications			List Price Per Grade		
		Dimensions	D	W	H	COM	
22" x 44" Ottoman 	OL7607 · optional casters, add \$92 list	Overall	22	44	16½	COM	\$779
		Upholstery		Shipping		A	\$812
		COM Ydg	3¾	Ctn Wt	66	B	\$877
		COL Sq Ft	75	Cu Ft	15	COL/C	\$991
						D	\$1,138
						E	\$1,285
						F	\$1,439
						G	\$1,658
						H	\$1,894
						I	\$2,260
						J	\$2,700
						L1	\$1,820
						L2	\$2,084

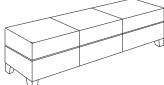
Description	Model	Specifications			List Price Per Grade		
		Dimensions	D	W	H	COM	
22" x 66" Ottoman 	OL7608 · optional casters, add \$92 list	Overall	22	66	16½	COM	\$879
		Upholstery		Shipping		A	\$923
		COM Ydg	5	Ctn Wt	92	B	\$1,011
		COL Sq Ft	100	Cu Ft	20	COL/C	\$1,163
						D	\$1,358
						E	\$1,553
						F	\$1,759
						G	\$2,053
						H	\$2,365
						I	\$2,854
						J	\$3,440
						L1	\$2,267
						L2	\$2,619

To Order, Specify:

- Model Number
- Wood Species - Maple (M)
- Wood Finish
- Fabric Selection - vendor, pattern and color
- Optional Tablet Arm - add \$491 list; indicate left (TBL) or right (TBR)
 Tilt and Stow
Tablet Arm Illustration
10"D x 16"W Surface
- Optional Rubber Cushion Nylon Glides - no upcharge

Wood Finish Options:

ALE Ale	FLX Flax
AUB Auburn	LGC Legacy
AUT Autumn	MCH Mocha
BRL Barley	NTO Night Owl
BBN Bourbon	PRL Praline
BRG Brighton	SAF Saffron
BUT Butterscotch	SIE Sienna
CIN Cinnamon	TOF Toffee
CLA Classic	TRF Truffle
EAR Earthy	VEN Venetian
ESP Espresso	

- See a selection of graded in fabric manufacturers and patterns on pages 12-20. Contact Customer Service for additional fabric options.

Specifications



- 3½" tall solid maple leg.
- Seat has synthetic sheet webbing with cross strap reinforcement, 6" polyurethane foam and fixed cushion.
- Back has 3½" polyurethane foam.
- Arms have ½" polyurethane foam.
- Mortise and tenon construction with corner blocks, glue and screws.
- Wood caps are ¾" thick maple veneer.
- Standard with rubber cushion metal glides.

When ordering Quickship products, place a "Q" in front of model number.
Example: QGT4901D

NOW!
Need it.
JSI Quickship

OLYMPIAN
FREESTANDING



Description	① Model	Specifications			List Price Per Grade	
30" x 30" Ottoman 	OL7605 · optional casters, add \$92 list	Dimensions	D	W	H	COM \$754
		Overall	30	30	16½	A \$786
		Upholstery	Shipping			B \$847
		COM Ydg	3½	Ctn Wt	85 (2/box)	COL/C \$953
		COL Sq Ft	81	Cu Ft	30	D \$1,089
						E \$1,226
						F \$1,371
						G \$1,575
						H \$1,795
						I \$2,137
						J \$2,548
						L1 \$1,890
						L2 \$2,178
36" x 36" Ottoman 	OL7606 · optional casters, add \$92 list	Dimensions	D	W	H	COM \$828
		Overall	36	36	16½	A \$868
		Upholstery	Shipping			B \$945
		COM Ydg	4½	Ctn Wt	105 (2/box)	COL/C \$1,083
		COL Sq Ft	104	Cu Ft	35	D \$1,258
						E \$1,435
						F \$1,621
						G \$1,884
						H \$2,166
						I \$2,606
						J \$3,133
						L1 \$2,288
						L2 \$2,658
18" x 18" POD 	OL7610 · casters standard	Dimensions	D	W	H	COM \$743
		Overall	18	18	18¼	A \$759
		Upholstery	Shipping			B \$789
		COM Ydg	1¾	Ctn Wt	85 (2/box)	COL/C \$843
		COL Sq Ft	35	Cu Ft	20	D \$911
						E \$979
						F \$1,052
						G \$1,153
						H \$1,264
						I \$1,435
						J \$1,640
						L1 \$1,229
						L2 \$1,352

LOUNGE

Description	D	W	H	CTN WT	CU FT	① Model	List Price
28" x 28" End Table	28	28	17	30	6	OL2828-17	\$530

NOW!

- maple veneer top



36" x 36" Magazine Table	36	36	17	40	8	OL3636-17	\$580
--------------------------	----	----	----	----	---	-----------	-------

NOW!

- maple veneer top



To Order, Specify:

- ① Model Number
- ② Wood Species - Maple (M)
- ③ Wood Finish
- ④ Fabric Selection - vendor, pattern and color
- ⑤ Optional Rubber Cushion Nylon Glides - no upcharge

⑥ Wood Finish Options:

ALE Ale	FLX Flax
AUB Auburn	LGC Legacy
AUT Autumn	MCH Mocha
BRL Barley	NTO Night Owl
BBN Bourbon	PRL Praline
BRG Brighton	SAF Saffron
BUT Butterscotch	SIE Sienna
CIN Cinnamon	TOF Toffee
CLA Classic	TRF Truffle
EAR Earthy	VEN Venetian
ESP Espresso	

- ④ See a selection of graded in fabric manufacturers and patterns on pages 12-20. Contact Customer Service for additional fabric options.

Specifications

- 3 1/2" tall solid maple leg.
- Seat has synthetic sheet webbing with cross strap reinforcement, 6" polyurethane foam and fixed cushion.
- Table tops are 1" thick maple veneer.
- Mortise and tenon construction with corner blocks, glue and screws.
- Standard with rubber cushion metal glides.

When ordering Quickship products, place a "Q" in front of model number.
Example: QGT4901D

NOW!
Need it.
JSI Quickship



Description	① Model	Specifications				List Price Per Grade	
21" Single Seat 	OL7821U · optional casters, add \$92 list	Dimensions		D	W	H	COM \$1,277
		Overall	29	28 ¼	34 ½	A \$1,321	
		Seat	20	21 ½	18 ¼	B \$1,409	
		Arm			24 ¾	COL/C \$1,561	
		Upholstery		Shipping		D \$1,756	
		COM Ydg	5	Ctn Wt	59	E \$1,951	
		COL Sq Ft	115	Cu Ft	30	F \$2,157	
						G \$2,451	
						H \$2,763	
						I \$3,252	
				J \$3,838			
				L1 \$2,901			
				L2 \$3,311			

21" Single Seat with Wood Cap Arm 	OL7821W · optional casters, add \$92 list · optional tablet arm, add \$491 list; specify TBL-left or TBR-right as seated	Dimensions		D	W	H	COM \$1,410
		Overall	29	28 ¼	34 ½	A \$1,454	
		Seat	20	21 ½	18 ¼	B \$1,541	
		Arm			25 ¼	COL/C \$1,693	
		Upholstery		Shipping		D \$1,888	
		COM Ydg	5	Ctn Wt	62	E \$2,084	
		COL Sq Ft	115	Cu Ft	30	F \$2,289	
						G \$2,583	
						H \$2,895	
						I \$3,385	
				J \$3,971			
				L1 \$3,033			
				L2 \$3,443			

31" Single Seat 	OL7822U	Dimensions		D	W	H	COM \$1,439
		Overall	29	38	34 ½	A \$1,501	
		Seat	20	31 ¼	18 ¼	B \$1,623	
		Arm			24 ¾	COL/C \$1,835	
		Upholstery		Shipping		D \$2,109	
		COM Ydg	7	Ctn Wt	71	E \$2,382	
		COL Sq Ft	161	Cu Ft	33	F \$2,672	
						G \$3,081	
						H \$3,519	
						I \$4,204	
				J \$5,025			
				L1 \$3,711			
				L2 \$4,286			

31" Single Seat with Wood Cap Arm 	OL7822W	Dimensions		D	W	H	COM \$1,573
		Overall	29	38	34 ½	A \$1,635	
		Seat	20	31 ¼	18 ¼	B \$1,757	
		Arm			25 ¼	COL/C \$1,969	
		Upholstery		Shipping		D \$2,243	
		COM Ydg	7	Ctn Wt	74	E \$2,516	
		COL Sq Ft	161	Cu Ft	33	F \$2,806	
						G \$3,216	
						H \$3,653	
						I \$4,338	
				J \$5,159			
				L1 \$3,846			
				L2 \$4,420			

LOUNGE

Description	Model	Specifications				List Price Per Grade	
31" Single Seat 	OL7822BU · bariatric · meets BIFMA x5.11 large occupant standard (253-400 lb individual)	Dimensions		D	W	H	COM \$1,901
		Overall	29	38	34 ½	A \$1,963	
		Seat	20	31 ¼	18 ¼	B \$2,085	
		Arm			24 ¾	COL/C \$2,297	
		Upholstery		Shipping		D \$2,571	
		COM Ydg	7	Ctn Wt	77	E \$2,844	
		COL Sq Ft	161	Cu Ft	33	F \$3,134	
						G \$3,543	
						H \$3,981	
						I \$4,666	
				J \$5,487			
				L1 \$4,173			
				L2 \$4,748			
31" Single Seat with Wood Cap Arm 	OL7822BW · bariatric · meets BIFMA x5.11 large occupant standard (253-400 lb individual)	Dimensions		D	W	H	COM \$2,034
		Overall	29	38	34 ½	A \$2,096	
		Seat	20	31 ¼	18 ¼	B \$2,218	
		Arm			25 ¼	COL/C \$2,430	
		Upholstery		Shipping		D \$2,704	
		COM Ydg	7	Ctn Wt	80	E \$2,977	
		COL Sq Ft	161	Cu Ft	33	F \$3,267	
						G \$3,677	
						H \$4,114	
						I \$4,799	
				J \$5,620			
				L1 \$4,307			
				L2 \$4,881			
42" Single Seat 	OL7823U	Dimensions		D	W	H	COM \$1,835
		Overall	29	49	34 ½	A \$1,914	
		Seat	20	42 ¼	18 ¼	B \$2,070	
		Arm			24 ¾	COL/C \$2,344	
		Upholstery		Shipping		D \$2,696	
		COM Ydg	9	Ctn Wt	79	E \$3,048	
		COL Sq Ft	207	Cu Ft	46	F \$3,419	
						G \$3,946	
						H \$4,509	
						I \$5,389	
				J \$6,444			
				L1 \$4,756			
				L2 \$5,494			

To Order, Specify:

- 1 Model Number
- 2 Wood Species - Maple (M)
- 3 Wood Finish
- 4 Fabric Selection - vendor, pattern and color
- 5 Optional Casters - add \$92 list
- 6 Optional Tablet Arm - add \$491 list; indicate left (TBL) or right (TBR)

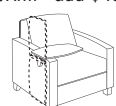

Tilt and Stow
 Tablet Arm Illustration
 10"D x 16"W Surface
- 7 Optional Rubber Cushion Nylon Glides - no upcharge

Wood Finish Options:

ALE Ale	FLX Flax
AUB Auburn	LGC Legacy
AUT Autumn	MCH Mocha
BRL Barley	NTO Night Owl
BBN Bourbon	PRL Praline
BRG Brighton	SAF Saffron
BUT Butterscotch	SIE Sienna
CIN Cinnamon	TOF Toffee
CLA Classic	TRF Truffle
EAR Earthy	VEN Venetian
ESP Espresso	

- 4 See a selection of graded in fabric manufacturers and patterns on pages 12-20. Contact Customer Service for additional fabric options.

Specifications

- 3 ½" tall solid maple leg.
- Seat has synthetic sheet webbing with cross strap reinforcement, 6" polyurethane foam and fixed cushion.
- Back has 3 ½" polyurethane foam.
- Arms have ½" polyurethane foam.
- Mortise and tenon construction with corner blocks, glue and screws.
- Wood caps are ¾" thick maple veneer.
- Standard with rubber cushion metal glides.

When ordering Quickship products, place a "Q" in front of model number.
 Example: QGT4901D



Description	① Model	Specifications				List Price Per Grade
42" Single Seat with Wood Cap Arm	OL7823W	Dimensions				COM \$1,967
		D	W	H		A \$2,046
		Overall	29	49	34 1/2	B \$2,202
		Seat	20	42 1/4	18 1/4	COL/C \$2,476
		Arm			25 1/4	D \$2,828
		Upholstery		Shipping		E \$3,180
		COM Ydg	9	Ctn Wt	82	F \$3,552
		COL Sq Ft	207	Cu Ft	46	G \$4,079
						H \$4,641
						I \$5,521
						J \$6,577
						L1 \$4,888
				L2 \$5,626		

42" Single Seat	OL7823BU	Dimensions				COM \$2,308
		D	W	H		A \$2,387
	<ul style="list-style-type: none"> · bariatric · meets BIFMA x5.11 large occupant standard (253-400 lb individual) 	Overall	29	49	34 1/2	B \$2,544
		Seat	20	42 1/4	18 1/4	COL/C \$2,818
		Arm			24 3/4	D \$3,169
		Upholstery		Shipping		E \$3,521
		COM Ydg	9	Ctn Wt	86	F \$3,893
		COL Sq Ft	207	Cu Ft	46	G \$4,420
						H \$4,983
						I \$5,863
						J \$6,918
						L1 \$5,229
				L2 \$5,968		

42" Single Seat with Wood Cap Arm	OL7823BW	Dimensions				COM \$2,442
		D	W	H		A \$2,520
	<ul style="list-style-type: none"> · bariatric · meets BIFMA x5.11 large occupant standard (253-400 lb individual) 	Overall	29	49	34 1/2	B \$2,677
		Seat	20	42 1/4	18 1/4	COL/C \$2,951
		Arm			25 1/4	D \$3,303
		Upholstery		Shipping		E \$3,654
		COM Ydg	9	Ctn Wt	89	F \$4,026
		COL Sq Ft	207	Cu Ft	46	G \$4,553
						H \$5,116
						I \$5,996
						J \$7,051
						L1 \$5,363
				L2 \$6,101		

Two Seat	OL7832U	Dimensions				COM \$2,284
		D	W	H		A \$2,363
		Overall	29	53 1/4	34 1/2	B \$2,519
		Seat	20	21 1/2	18 1/4	COL/C \$2,793
		Arm			24 3/4	D \$3,145
		Upholstery		Shipping		E \$3,497
		COM Ydg	9	Ctn Wt	98	F \$3,869
		COL Sq Ft	207	Cu Ft	46	G \$4,396
						H \$4,959
						I \$5,838
						J \$6,894
						L1 \$5,205
				L2 \$5,943		

LOUNGE

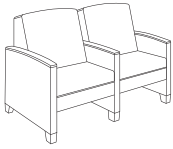
Description	Model	Specifications			List Price Per Grade		
Two Seat with Wood Cap Arm 	OL7832W	Dimensions	D	W	H	COM	\$2,485
		Overall	29	53 ¼	34 ½	A	\$2,564
		Seat	20	21 ½	18 ¼	B	\$2,720
		Arm			25 ¼	COL/C	\$2,994
		Upholstery	Shipping			D	\$3,346
		COM Ydg	9	Ctn Wt	103	E	\$3,698
		COL Sq Ft	207	Cu Ft	46	F	\$4,069
						G	\$4,596
						H	\$5,159
						I	\$6,039
				J	\$7,094		
				L1	\$5,406		
				L2	\$6,144		

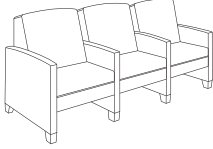
Description	Model	Specifications			List Price Per Grade		
Three Seat 	OL7843U	Dimensions	D	W	H	COM	\$3,328
		Overall	29	78	34 ½	A	\$3,451
		Seat	20	21 ½	18 ¼	B	\$3,694
		Arm			24 ¾	COL/C	\$4,120
		Upholstery	Shipping			D	\$4,667
		COM Ydg	14	Ctn Wt	139	E	\$5,214
		COL Sq Ft	322	Cu Ft	64	F	\$5,792
						G	\$6,612
						H	\$7,488
						I	\$8,857
				J	\$10,498		
				L1	\$7,871		
				L2	\$9,020		

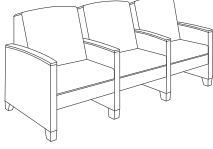
Description	Model	Specifications			List Price Per Grade		
Three Seat with Wood Cap Arm 	OL7843W	Dimensions	D	W	H	COM	\$3,594
		Overall	29	78	34 ½	A	\$3,716
		Seat	20	21 ½	18 ¼	B	\$3,960
		Arm			25 ¼	COL/C	\$4,385
		Upholstery	Shipping			D	\$4,932
		COM Ydg	14	Ctn Wt	145	E	\$5,479
		COL Sq Ft	322	Cu Ft	64	F	\$6,058
						G	\$6,878
						H	\$7,754
						I	\$9,123
				J	\$10,764		
				L1	\$8,137		
				L2	\$9,286		

To Order, Specify:

- 1 Model Number
- 2 Wood Species - Maple (M)
- 3 Wood Finish
- 4 Fabric Selection - vendor, pattern and color
- 5 Optional Casters - add \$92 list
- 6 Optional Tablet Arm - add \$491 list; indicate left (TBL) or right (TBR)



Tilt and Stow
Tablet Arm Illustration
10"D x 16"W Surface
- 7 Optional Rubber Cushion Nylon Glides - no upcharge

6 Wood Finish Options:

- | | |
|------------------|---------------|
| ALE Ale | FLX Flax |
| AUB Auburn | LGC Legacy |
| AUT Autumn | MCH Mocha |
| BRL Barley | NTO Night Owl |
| BBN Bourbon | PRL Praline |
| BRG Brighton | SAF Saffron |
| BUT Butterscotch | SIE Sienna |
| CIN Cinnamon | TOF Toffee |
| CLA Classic | TRF Truffle |
| EAR Earthy | VEN Venetian |
| ESP Espresso | |

- 4 See a selection of graded in fabric manufacturers and patterns on pages 12-20. Contact Customer Service for additional fabric options.

Specifications

- 3 ½" tall solid maple leg.
- Seat has synthetic sheet webbing with cross strap reinforcement, 6" polyurethane foam and fixed cushion.
- Back has 3 ½" polyurethane foam.
- Arms have ½" polyurethane foam.
- Mortise and tenon construction with corner blocks, glue and screws.
- Wood caps are ¾" thick maple veneer.
- Standard with rubber cushion metal glides.

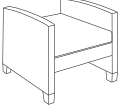
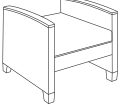
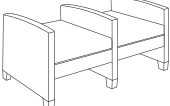
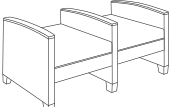
Description	① Model	Specifications				List Price Per Grade
 Single Seat Bench	OL7891U · optional casters, add \$92 list · optional tablet arm, add \$491 list; specify TBL-left or TBR-right as seated	Dimensions				COM \$769 A \$809 B \$887 COL/C \$1,024 D \$1,200 E \$1,376 F \$1,562 G \$1,825 H \$2,107 I \$2,547 J \$3,074 L1 \$2,230 L2 \$2,599
		Overall	29	28 ¼	24 ¾	
		Seat	29	21 ½	18 ¼	
		Arm			24 ¾	
		Upholstery		Shipping		
		COM Ydg	4 ½	Ctn Wt	50	
		COL Sq Ft	104	Cu Ft	20	
 Single Seat Bench with Wood Cap Arm	OL7891W · optional casters, add \$92 list · optional tablet arm, add \$491 list; specify TBL-left or TBR-right as seated	Dimensions				COM \$901 A \$941 B \$1,019 COL/C \$1,157 D \$1,332 E \$1,508 F \$1,694 G \$1,958 H \$2,239 I \$2,679 J \$3,206 L1 \$2,362 L2 \$2,732
		Overall	29	28 ¼	25 ¼	
		Seat	29	21 ½	18 ¼	
		Arm			25 ¼	
		Upholstery		Shipping		
		COM Ydg	4 ½	Ctn Wt	53	
		COL Sq Ft	104	Cu Ft	20	
 Two Seat Bench	OL7892U	Dimensions				COM \$1,313 A \$1,379 B \$1,509 COL/C \$1,737 D \$2,030 E \$2,324 F \$2,633 G \$3,073 H \$3,542 I \$4,275 J \$5,155 L1 \$3,747 L2 \$4,363
		Overall	29	53	24 ¾	
		Seat	29	21 ½	18 ¼	
		Arm			24 ¾	
		Upholstery		Shipping		
		COM Ydg	7 ½	Ctn Wt	80	
		COL Sq Ft	173	Cu Ft	35	
 Two Seat Bench with Wood Cap Arm	OL7892W	Dimensions				COM \$1,512 A \$1,579 B \$1,709 COL/C \$1,937 D \$2,230 E \$2,524 F \$2,832 G \$3,272 H \$3,742 I \$4,475 J \$5,354 L1 \$3,946 L2 \$4,563
		Overall	29	53	25 ¼	
		Seat	29	21 ½	18 ¼	
		Arm			25 ¼	
		Upholstery		Shipping		
		COM Ydg	7 ½	Ctn Wt	83	
		COL Sq Ft	173	Cu Ft	35	

LOUNGE

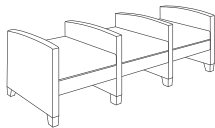
Description	Model	Specifications			List Price Per Grade	
Three Seat Bench 	OL7893U	Dimensions	D	W	H	COM \$1,855
		Overall	29	77 ¾	24 ¾	A \$1,947
		Seat	29	21 ½	18 ¼	B \$2,130
		Arm			24 ¾	COL/C \$2,449
		Upholstery	Shipping			D \$2,860
		COM Ydg	10 ½	Ctn Wt	110	E \$3,269
		COL Sq Ft	242	Cu Ft	50	F \$3,703
						G \$4,318
						H \$4,975
						I \$6,001
				J \$7,233		
				L1 \$5,263		
				L2 \$6,124		

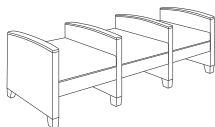
Description	Model	Specifications			List Price Per Grade	
Three Seat Bench with Wood Cap Arm 	OL7893W	Dimensions	D	W	H	COM \$2,123
		Overall	29	77 ¾	25 ¼	A \$2,215
		Seat	29	21 ½	18 ¼	B \$2,398
		Arm			25 ¼	COL/C \$2,717
		Upholstery	Shipping			D \$3,127
		COM Ydg	10 ½	Ctn Wt	113	E \$3,537
		COL Sq Ft	242	Cu Ft	50	F \$3,971
						G \$4,586
						H \$5,243
						I \$6,269
				J \$7,501		
				L1 \$5,531		
				L2 \$6,392		

To Order, Specify:

- 1 Model Number
- 2 Wood Species - Maple (M)
- 3 Wood Finish
- 4 Metal Color - Black Sandtex (BSX) or Stardust Silver (STS)
- 5 Fabric Selection - vendor, pattern and color
- 6 Optional Tablet Arm - add \$491 list; indicate left (TBL) or right (TBR)



Tilt and Stow
Tablet Arm Illustration
10"D x 16"W Surface
- 7 Optional Rubber Cushion Nylon Glides - no upcharge

3 Wood Finish Options:

ALE Ale	FLX Flax
AUB Auburn	LGC Legacy
AUT Autumn	MCH Mocha
BRL Barley	NTO Night Owl
BBN Bourbon	PRL Praline
BRG Brighton	SAF Saffron
BUT Butterscotch	SIE Sienna
CIN Cinnamon	TOF Toffee
CLA Classic	TRF Truffle
EAR Earthy	VEN Venetian
ESP Espresso	

- 4 See a selection of graded in fabric manufacturers and patterns on pages 12-20. Contact Customer Service for additional fabric options.

Specifications

- 3 ½" tall solid maple leg.
- Seat has synthetic sheet webbing with cross strap reinforcement, 6" polyurethane foam and fixed cushion.
- Arms have ½" polyurethane foam.
- Mortise and tenon construction with corner blocks, glue and screws.
- Standard with rubber cushion metal glides.

Description	D	W	H	CTN WT	CU FT	① Model	List Price
Modular End Table 20"	28	20	17	30	4	OL78E2	\$521

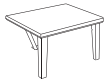

· specify metal finish color - Black Sandtex or Stardust Silver



Front

Modular Linking Table 10"	28	10	17	18	4	OL78C	\$521
---------------------------	----	----	----	----	---	--------------	-------



· specify metal finish color - Black Sandtex or Stardust Silver

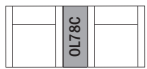

Front

Modular Linking Table 20"	28	20	17	27	4	OL78C2	\$521
---------------------------	----	----	----	----	---	---------------	-------



· specify metal finish color - Black Sandtex or Stardust Silver



Front

Modular 90° Linking L Table 28"	28	28	17	38	6	OL78CL	\$521
---------------------------------	----	----	----	----	---	---------------	-------



· specify metal finish color - Black Sandtex or Stardust Silver

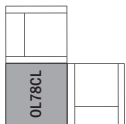

Top View

Modular 90° Linking T Table 28"	28	28	17	38	6	OL78CT	\$521
---------------------------------	----	----	----	----	---	---------------	-------



· specify metal finish color - Black Sandtex or Stardust Silver

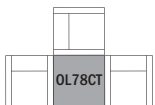

Top View

Description	D	W	H	CTN WT	CU FT	① Model	List Price
Modular 90° Linking X Table 28"	28	28	17	40	6	OL78CX	\$521



- specify metal finish color - Black Sandtex or Stardust Silver

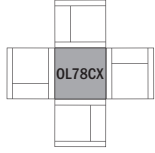

Top View

Modular 22.5° Linking Table	28	14 ¾	17	17	4	OL78C22	\$521
-----------------------------	----	------	----	----	---	---------	-------



- specify metal finish color -Black Sandtex or Stardust Silver
- overall width range is 4 - 14 ¾

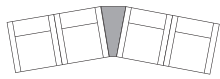

Front

Modular 30° Linking Table	28	18 ¼	17	18	4	OL78C30	\$521
---------------------------	----	------	----	----	---	---------	-------



- specify metal finish color - Black Sandtex or Stardust Silver
- overall width range is 4 - 18 ¼

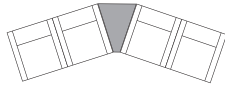

Front

Modular 45° Linking Table	28	25 ⅞	17	22	6	OL78C45	\$521
---------------------------	----	------	----	----	---	---------	-------

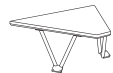

- specify metal finish color - Black Sandtex or Stardust Silver
- overall width range is 4 - 25 ⅞

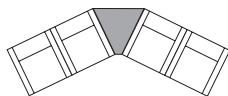

Front

To Order, Specify:

- ① Model Number
- ② Wood Species - Maple (M)
- ③ Wood Finish
- ④ Metal Color - Black Sandtex (BSX) or Stardust Silver (STS)

⑤ Wood Finish Options:

ALE Ale	FLX Flax
AUB Auburn	LGC Legacy
AUT Autumn	MCH Mocha
BRL Barley	NTO Night Owl
BBN Bourbon	PRL Praline
BRG Brighton	SAF Saffron
BUT Butterscotch	SIE Sienna
CIN Cinnamon	TOF Toffee
CLA Classic	TRF Truffle
EAR Earthy	VEN Venetian
ESP Espresso	

Specifications

- 3 ½" tall solid maple leg.
- Table tops are 1" thick maple veneer.

Portrait Lounge Order Check List:



Specify:

- 1. Model Number
- 2. Wood Species - Maple (M)
- 3. Wood Finish
- 4. Fabric Selection - vendor, pattern and color
- 5. Button/Reverse Diamond Detail - Add \$139 list for single seat unit, \$180 list for two seat unit and \$300 list for three seat unit

Example:

PO9060 | M | AUB | MOMENTUM | VOX | MYSTIC
 (model #) | (wood species) | (finish) | (fabric vendor) | (pattern name) | (pattern color)

1. Model Number

2. Wood Species - Maple (M)

3. Wood Finish Options: ▲

ALE Ale	FLX Flax
AUB Auburn	CGR Graphite Coordinate
AUT Autumn	CHL High Line Coordinate
BRL Barley	CKC Khaki Coordinate
CBE Blonde Echo Coordinate	LGC Legacy
BBN Bourbon	MCH Mocha
CBZ Brazilwood Coordinate	NTO Night Owl
BRG Brighton	PRL Praline
BUT Butterscotch	SAF Saffron
CIN Cinnamon	SIE Sienna
CLA Classic	CST Studio Teak Coordinate
CCF Coffee Coordinate	TOF Toffee
CCR Cremello Coordinate	TRF Truffle
EAR Earthy	VEN Venetian
ESP Espresso	CWH Walnut Heights Coordinate

4. Fabric Selection - Please supply the following:

- Fabric vendor
- Pattern name
- Pattern color

When specifying contrasting upholstery, indicate clearly which upholstery is to be applied to the seat, back and arms. Use higher grade pricing.

- Indicate direction of fabric - Railroaded or Up the Roll
- Please provide illustration, if available

All COM orders must include the following:

- Vendor's name, pattern name and color
- Sample of the fabric attached to order
- Model numbers of items for fabric application
- Special application instructions (e.g., all stripes will be applied front to back unless specified otherwise)
- Customer and purchase order number

Ship prepaid COM material to:
 JSI
 Attn: COM Dept
 932 Mill Street
 Jasper, IN 47546

Application of fabric:
 Railroaded Up the Roll

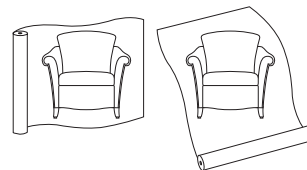

All COM orders will ship at standard lead time from receipt of COM except for orders requiring special custom matched finishes.

5. Button/Reverse Diamond Detail - add \$139 list for single seat unit, \$180 list for two seat unit and \$300 list for three seat unit. Fabric direction on top and bottom sections run with the nap. Side sections run railroad. Ex: stripes run vertical on top and bottom sections and horizontal on side sections.

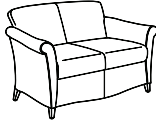
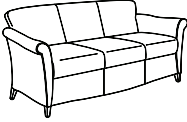

Description	Model	Specifications			List Price Per Grade	
Single Seat 	P09060 · scroll arms	Dimensions	D	W	H	COM \$2,285
		Overall	31 ½	33 ½	35 ½	A \$2,347
		Seat	19 ½	23	19 ½	B \$2,469
		Arm			24 ½	COL/C \$2,681
		Upholstery	Shipping			D \$2,955
		COM Ydg	6 ½ ▲	Ctn Wt	61	E \$3,228
		COL Sq Ft	130 ▲	Cu Ft	25	F \$3,518
						G \$3,927
						H \$4,365
						I \$5,050
				J \$5,871		
				L1 \$4,229		
				L2 \$4,721		
Two Seat 	P09070 · scroll arms	Dimensions	D	W	H	COM \$3,182
		Overall	31 ½	55	35	A \$3,261
		Seat	19 ½	43	19 ½	B \$3,417
		Arm			24 ½	COL/C \$3,691
		Upholstery	Shipping			D \$4,043
		COM Ydg	8 ▲	Ctn Wt	120	E \$4,395
		COL Sq Ft	160 ▲	Cu Ft	40	F \$4,766
						G \$5,294
						H \$5,856
						I \$6,736
				J \$7,791		
				L1 \$6,103		
				L2 \$6,841		
Three Seat 	P09080 · scroll arms	Dimensions	D	W	H	COM \$3,972
		Overall	31 ½	76 ¾	35 ½	A \$4,077
		Seat	19 ½	64 ¾	19 ½	B \$4,286
		Arm			24 ½	COL/C \$4,650
		Upholstery	Shipping			D \$5,119
		COM Ydg	10 ½ ▲	Ctn Wt	140	E \$5,589
		COL Sq Ft	210 ▲	Cu Ft	56	F \$6,083
						G \$6,788
						H \$7,537
						I \$8,710
				J \$10,118		
				L1 \$7,866		
				L2 \$8,851		

To Order, Specify:

- 1 Model Number
- 2 Wood Species - Maple (M)
- 3 Wood Finish
- 4 Fabric Selection - vendor, pattern and color
- 5 Button/Reverse Diamond Detail - add \$139 list for single seat unit, \$180 list for two seat unit and \$300 list for three seat unit

3 Wood Finish Options: ▲

ALE Ale	FLX Flax
AUB Auburn	CGR Graphite Coordinate
AUT Autumn	CHL High Line Coordinate
BRL Barley	CKC Khaki Coordinate
CBE Blonde Echo Coordinate	LGC Legacy
BBN Bourbon	MCH Mocha
CBZ Brazilwood Coordinate	NTO Night Owl
BRG Brighton	PRL Praline
BUT Butterscotch	SAF Saffron
CIN Cinnamon	SIE Sienna
CLA Classic	CST Studio Teak Coordinate
CCF Coffee Coordinate	TOF Toffee
CCR Cremello Coordinate	TRF Truffle
EAR Earthy	VEN Venetian
ESP Espresso	CWH Walnut Heights Coordinate

- 4 See a selection of graded in fabric manufacturers and patterns on pages 12-20. Contact Customer Service for additional fabric options.

Specifications

- Leg wood species - Maple.
- Fully upholstered.
- Frame interior is hardwood joined with dowels reinforced with wood screws.
- Seat has synthetic sheet webbing with cross strap reinforcement and high resiliency seat polyurethane foam with Dacron® wrap.
- Back has polypropylene webbing and polyurethane foam with Dacron® wrap.
- Arm is foam wrap with Dacron®.

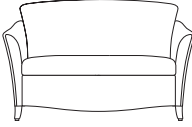
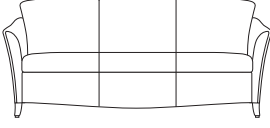
Description	① Model	Specifications	List Price Per Grade																																										
Single Seat 	P09065 · regency arms	<table border="1"> <thead> <tr> <th>Dimensions</th> <th>D</th> <th>W</th> <th>H</th> </tr> </thead> <tbody> <tr> <td>Overall</td> <td>31 ½</td> <td>30 ½</td> <td>35</td> </tr> <tr> <td>Seat</td> <td>19 ½</td> <td>23</td> <td>19 ½</td> </tr> <tr> <td>Arm</td> <td></td> <td></td> <td>24 ½</td> </tr> </tbody> </table>	Dimensions	D	W	H	Overall	31 ½	30 ½	35	Seat	19 ½	23	19 ½	Arm			24 ½	<table border="1"> <tbody> <tr><td>COM</td><td>\$2,285</td></tr> <tr><td>A</td><td>\$2,347</td></tr> <tr><td>B</td><td>\$2,469</td></tr> <tr><td>COL/C</td><td>\$2,681</td></tr> <tr><td>D</td><td>\$2,955</td></tr> <tr><td>E</td><td>\$3,228</td></tr> <tr><td>F</td><td>\$3,518</td></tr> <tr><td>G</td><td>\$3,927</td></tr> <tr><td>H</td><td>\$4,365</td></tr> <tr><td>I</td><td>\$5,050</td></tr> <tr><td>J</td><td>\$5,871</td></tr> <tr><td>L1</td><td>\$4,229</td></tr> <tr><td>L2</td><td>\$4,721</td></tr> </tbody> </table>	COM	\$2,285	A	\$2,347	B	\$2,469	COL/C	\$2,681	D	\$2,955	E	\$3,228	F	\$3,518	G	\$3,927	H	\$4,365	I	\$5,050	J	\$5,871	L1	\$4,229	L2	\$4,721
		Dimensions	D	W	H																																								
		Overall	31 ½	30 ½	35																																								
		Seat	19 ½	23	19 ½																																								
		Arm			24 ½																																								
		COM	\$2,285																																										
		A	\$2,347																																										
		B	\$2,469																																										
		COL/C	\$2,681																																										
		D	\$2,955																																										
E	\$3,228																																												
F	\$3,518																																												
G	\$3,927																																												
H	\$4,365																																												
I	\$5,050																																												
J	\$5,871																																												
L1	\$4,229																																												
L2	\$4,721																																												
<table border="1"> <thead> <tr> <th>Upholstery</th> <th colspan="2">Shipping</th> </tr> </thead> <tbody> <tr> <td>COM Ydg</td> <td>6 ½ ▲</td> <td>Ctn Wt 61</td> </tr> <tr> <td>COL Sq Ft</td> <td>130 ▲</td> <td>Cu Ft 23</td> </tr> </tbody> </table>		Upholstery	Shipping		COM Ydg	6 ½ ▲	Ctn Wt 61	COL Sq Ft	130 ▲	Cu Ft 23																																			
Upholstery	Shipping																																												
COM Ydg	6 ½ ▲	Ctn Wt 61																																											
COL Sq Ft	130 ▲	Cu Ft 23																																											
Two Seat 	P09075 · regency arms	<table border="1"> <thead> <tr> <th>Dimensions</th> <th>D</th> <th>W</th> <th>H</th> </tr> </thead> <tbody> <tr> <td>Overall</td> <td>31 ½</td> <td>57</td> <td>35</td> </tr> <tr> <td>Seat</td> <td>19 ½</td> <td>43</td> <td>19 ½</td> </tr> <tr> <td>Arm</td> <td></td> <td></td> <td>24 ½</td> </tr> </tbody> </table>	Dimensions	D	W	H	Overall	31 ½	57	35	Seat	19 ½	43	19 ½	Arm			24 ½	<table border="1"> <tbody> <tr><td>COM</td><td>\$3,032</td></tr> <tr><td>A</td><td>\$3,111</td></tr> <tr><td>B</td><td>\$3,267</td></tr> <tr><td>COL/C</td><td>\$3,541</td></tr> <tr><td>D</td><td>\$3,893</td></tr> <tr><td>E</td><td>\$4,245</td></tr> <tr><td>F</td><td>\$4,616</td></tr> <tr><td>G</td><td>\$5,143</td></tr> <tr><td>H</td><td>\$5,706</td></tr> <tr><td>I</td><td>\$6,586</td></tr> <tr><td>J</td><td>\$7,641</td></tr> <tr><td>L1</td><td>\$5,953</td></tr> <tr><td>L2</td><td>\$6,691</td></tr> </tbody> </table>	COM	\$3,032	A	\$3,111	B	\$3,267	COL/C	\$3,541	D	\$3,893	E	\$4,245	F	\$4,616	G	\$5,143	H	\$5,706	I	\$6,586	J	\$7,641	L1	\$5,953	L2	\$6,691
		Dimensions	D	W	H																																								
		Overall	31 ½	57	35																																								
		Seat	19 ½	43	19 ½																																								
		Arm			24 ½																																								
		COM	\$3,032																																										
		A	\$3,111																																										
		B	\$3,267																																										
		COL/C	\$3,541																																										
		D	\$3,893																																										
E	\$4,245																																												
F	\$4,616																																												
G	\$5,143																																												
H	\$5,706																																												
I	\$6,586																																												
J	\$7,641																																												
L1	\$5,953																																												
L2	\$6,691																																												
<table border="1"> <thead> <tr> <th>Upholstery</th> <th colspan="2">Shipping</th> </tr> </thead> <tbody> <tr> <td>COM Ydg</td> <td>8 ▲</td> <td>Ctn Wt 120</td> </tr> <tr> <td>COL Sq Ft</td> <td>160 ▲</td> <td>Cu Ft 42</td> </tr> </tbody> </table>		Upholstery	Shipping		COM Ydg	8 ▲	Ctn Wt 120	COL Sq Ft	160 ▲	Cu Ft 42																																			
Upholstery	Shipping																																												
COM Ydg	8 ▲	Ctn Wt 120																																											
COL Sq Ft	160 ▲	Cu Ft 42																																											
Three Seat 	P09085 · regency arms	<table border="1"> <thead> <tr> <th>Dimensions</th> <th>D</th> <th>W</th> <th>H</th> </tr> </thead> <tbody> <tr> <td>Overall</td> <td>31 ½</td> <td>78 ¾</td> <td>35</td> </tr> <tr> <td>Seat</td> <td>19 ½</td> <td>64 ¾</td> <td>19 ½</td> </tr> <tr> <td>Arm</td> <td></td> <td></td> <td>24 ½</td> </tr> </tbody> </table>	Dimensions	D	W	H	Overall	31 ½	78 ¾	35	Seat	19 ½	64 ¾	19 ½	Arm			24 ½	<table border="1"> <tbody> <tr><td>COM</td><td>\$3,813</td></tr> <tr><td>A</td><td>\$3,918</td></tr> <tr><td>B</td><td>\$4,127</td></tr> <tr><td>COL/C</td><td>\$4,491</td></tr> <tr><td>D</td><td>\$4,961</td></tr> <tr><td>E</td><td>\$5,430</td></tr> <tr><td>F</td><td>\$5,925</td></tr> <tr><td>G</td><td>\$6,629</td></tr> <tr><td>H</td><td>\$7,379</td></tr> <tr><td>I</td><td>\$8,552</td></tr> <tr><td>J</td><td>\$9,960</td></tr> <tr><td>L1</td><td>\$7,707</td></tr> <tr><td>L2</td><td>\$8,692</td></tr> </tbody> </table>	COM	\$3,813	A	\$3,918	B	\$4,127	COL/C	\$4,491	D	\$4,961	E	\$5,430	F	\$5,925	G	\$6,629	H	\$7,379	I	\$8,552	J	\$9,960	L1	\$7,707	L2	\$8,692
		Dimensions	D	W	H																																								
		Overall	31 ½	78 ¾	35																																								
		Seat	19 ½	64 ¾	19 ½																																								
		Arm			24 ½																																								
		COM	\$3,813																																										
		A	\$3,918																																										
		B	\$4,127																																										
		COL/C	\$4,491																																										
		D	\$4,961																																										
E	\$5,430																																												
F	\$5,925																																												
G	\$6,629																																												
H	\$7,379																																												
I	\$8,552																																												
J	\$9,960																																												
L1	\$7,707																																												
L2	\$8,692																																												
<table border="1"> <thead> <tr> <th>Upholstery</th> <th colspan="2">Shipping</th> </tr> </thead> <tbody> <tr> <td>COM Ydg</td> <td>10 ½ ▲</td> <td>Ctn Wt 140</td> </tr> <tr> <td>COL Sq Ft</td> <td>210 ▲</td> <td>Cu Ft 57</td> </tr> </tbody> </table>		Upholstery	Shipping		COM Ydg	10 ½ ▲	Ctn Wt 140	COL Sq Ft	210 ▲	Cu Ft 57																																			
Upholstery	Shipping																																												
COM Ydg	10 ½ ▲	Ctn Wt 140																																											
COL Sq Ft	210 ▲	Cu Ft 57																																											

LOUNGE

To Order, Specify:

- ① Model Number
- ② Wood Species - Maple (M)
- ③ Wood Finish
- ④ Fabric Selection - vendor, pattern and color
- ⑤ Button/Reverse Diamond Detail - add \$139 list for single seat unit, \$180 list for two seat unit and \$300 list for three seat unit

③ Wood Finish Options: ▲

ALE Ale	FLX Flax
AUB Auburn	CGR Graphite Coordinate
AUT Autumn	CHL High Line Coordinate
BRL Barley	CKC Khaki Coordinate
CBE Blonde Echo Coordinate	LGC Legacy
BBN Bourbon	MCH Mocha
CBZ Brazilwood Coordinate	NTO Night Owl
BRG Brighton	PRL Praline
BUT Butterscotch	SAF Saffron
CIN Cinnamon	SIE Sienna
CLA Classic	CST Studio Teak Coordinate
CCF Coffee Coordinate	TOF Toffee
CCR Cremello Coordinate	TRF Truffle
EAR Earthy	VEN Venetian
ESP Espresso	CWH Walnut Heights Coordinate

- ④ See a selection of graded in fabric manufacturers and patterns on pages 12-20. Contact Customer Service for additional fabric options.

Specifications

- Leg wood species - Maple.
- Fully upholstered.
- Frame interior is hardwood joined with dowels reinforced with wood screws.
- Seat has synthetic sheet webbing with cross strap reinforcement and high resiliency seat polyurethane foam with Dacron® wrap.
- Back has polypropylene webbing and polyurethane foam with Dacron® wrap.
- Arm is foam wrap with Dacron®.

Solara Lounge Order Check List:



Specify:

- 1. Model Number
- 2. Wood Species - Maple (M)
- 3. Wood Finish
- 4. Fabric Selection - vendor, pattern and color

Example:

S07361 | **M** | **AUB** | **MOMENTUM** | **VOX** | **MYSTIC**
 (model #) | (wood species) | (finish) | (fabric vendor) | (pattern name) | (pattern color)

1. Model Number

2. Wood Species - Maple (M)

3. Wood Finish Options:

ALE Ale	FLX Flax
AUB Auburn	LGC Legacy
AUT Autumn	MCH Mocha
BRL Barley	NTO Night Owl
BBN Bourbon	PRL Praline
BRG Brighton	SAF Saffron
BUT Butterscotch	SIE Sienna
CIN Cinnamon	TOF Toffee
CLA Classic	TRF Truffle
EAR Earthy	VEN Venetian
ESP Espresso	

4. Fabric Selection - Please supply the following:

- Fabric vendor
- Pattern name
- Pattern color

When specifying contrasting upholstery, indicate clearly which upholstery is to be applied to the seat, back and arms. Use higher grade pricing.

- Indicate direction of fabric - Railroaded or Up the Roll
- Please provide illustration, if available

All COM orders must include the following:

- Vendor's name, pattern name and color
- Sample of the fabric attached to order
- Model numbers of items for fabric application
- Special application instructions (e.g., all stripes will be applied front to back unless specified otherwise)
- Customer and purchase order number

Ship prepaid COM material to:
 JSI
 Attn: COM Dept
 932 Mill Street
 Jasper, IN 47546

Application of fabric:
 Railroaded Up the Roll

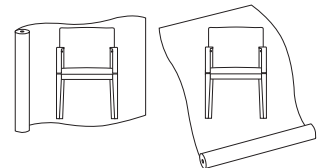

All COM orders will ship at standard lead time from receipt of COM except for orders requiring special custom matched finishes.

Description

① Model

Specifications

List Price Per Grade

Single Seat

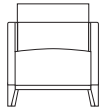

S07361

- upholstered arms and seat
- partially upholstered back
- wood back top rail

Dimensions	D	W	H
Overall	27 ¾	29 ½	33
Seat	21 ¼	24	17 ½
Arm			27 ½
Upholstery		Shipping	
COM Ydg	4 ½	Ctn Wt	73
COL Sq Ft	104	Cu Ft	18

COM	\$3,044
A	\$3,084
B	\$3,162
COL/C	\$3,300
D	\$3,475
E	\$3,651
F	\$3,837
G	\$4,101
H	\$4,382
I	\$4,822
J	\$5,349
L1	\$4,505
L2	\$4,875

Two Seat

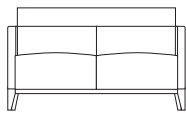

S07370

- upholstered arms and seat
- partially upholstered back
- wood back top rail

Dimensions	D	W	H
Overall	27 ¾	60	33
Seat	21 ¼	54 ½	17 ½
Arm			27 ½
Upholstery		Shipping	
COM Ydg	7 ¾	Ctn Wt	121
COL Sq Ft	179	Cu Ft	36

COM	\$3,538
A	\$3,606
B	\$3,741
COL/C	\$3,977
D	\$4,279
E	\$4,583
F	\$4,902
G	\$5,357
H	\$5,842
I	\$6,599
J	\$7,508
L1	\$6,054
L2	\$6,689

Three Seat

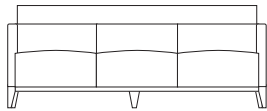

S07380

- upholstered arms and seat
- partially upholstered back
- wood back top rail

Dimensions	D	W	H
Overall	27 ¾	84	33
Seat	21 ¼	79	17 ½
Arm			27 ½
Upholstery		Shipping	
COM Ydg	11	Ctn Wt	141
COL Sq Ft	253	Cu Ft	50

COM	\$4,035
A	\$4,131
B	\$4,322
COL/C	\$4,657
D	\$5,087
E	\$5,517
F	\$5,971
G	\$6,615
H	\$7,303
I	\$8,378
J	\$9,669
L1	\$7,605
L2	\$8,508

60" W Bench





S07360



- upholstered seat

Dimensions	D	W	H
Overall	20	60	18
Upholstery		Shipping	
COM Ydg	3	Ctn Wt	100
COL Sq Ft	60	Cu Ft	15

COM	\$1,528
A	\$1,554
B	\$1,607
COL/C	\$1,698
D	\$1,816
E	\$1,932
F	\$2,056
G	\$2,233
H	\$2,420
I	\$2,714
J	\$3,065
L1	\$2,362
L2	\$2,573

Description	Model	Specifications				List Price Per Grade	
48" W Bench 	S07348 · upholstered seat	Dimensions		D	W	H	COM \$1,299
		Overall		20	48	18	A \$1,317
		Upholstery		Shipping			B \$1,352
		COM Ydg	2	Ctn Wt	64	COL/C \$1,413	
		COL Sq Ft	40	Cu Ft	12	D \$1,491	
						E \$1,569	
				F \$1,652			
				G \$1,769			
				H \$1,894			
				I \$2,090			
				J \$2,324			
				L1 \$1,855			
				L2 \$1,995			

Single Seat Bench  	S07336 · upholstered seat · exposed wood frame · set of two trays with aluminum laminate surface and wood sides available, specify and add \$336 list	Dimensions		D	W	H	COM \$1,116
		Overall		36	36	15	A \$1,138
		Upholstery		Shipping			B \$1,182
		COM Ydg	2 1/2	Ctn Wt	80	COL/C \$1,257	
		COL Sq Ft	58	Cu Ft	14	D \$1,355	
						E \$1,453	
				F \$1,556			
				G \$1,703			
				H \$1,859			
				I \$2,104			
				J \$2,397			
				L1 \$1,927			
				L2 \$2,133			

Single Seat Bench  	S07330 · upholstered seat · exposed wood frame · set of two trays with aluminum laminate surface and wood sides available, specify and add \$309 list	Dimensions		D	W	H	COM \$1,022
		Overall		30	30	15	A \$1,042
		Upholstery		Shipping			B \$1,081
		COM Ydg	2 1/4	Ctn Wt	56	COL/C \$1,150	
		COL Sq Ft	52	Cu Ft	10	D \$1,237	
						E \$1,326	
				F \$1,419			
				G \$1,550			
				H \$1,691			
				I \$1,911			
				J \$2,175			
				L1 \$1,753			
				L2 \$1,938			

To Order, Specify:

- 1 Model Number
- 2 Wood Species - Maple (M)
- 3 Wood Finish
- 4 Fabric Selection - vendor, pattern and color

3 Wood Finish Options:

ALE Ale	FLX Flax
AUB Auburn	LGC Legacy
AUT Autumn	MCH Mocha
BRL Barley	NTO Night Owl
BBN Bourbon	PRL Praline
BRG Brighton	SAF Saffron
BUT Butterscotch	SIE Sienna
CIN Cinnamon	TOF Toffee
CLA Classic	TRF Truffle
EAR Earthy	VEN Venetian
ESP Espresso	

- 4 See a selection of graded in fabric manufacturers and patterns on pages 12-20. Contact Customer Service for additional fabric options.

Specifications

- Wood species - Maple.
- Frame exterior is joined with dowels.
- Seat box reinforced with corner blocks.
- Frame interior is hardwood joined with dowels reinforced with corner blocks.
- Seat has synthetic sheet webbing with cross strap reinforcement and high resiliency seat polyurethane foam with Dacron® wrap.
- Back has polypropylene webbing and polyurethane foam with Dacron® wrap.
- Exposed back is molded maple plywood veneer.
- Back interior is molded plywood shell, high density foam with Dacron® wrap.

Description	D	W	H	CTN WT	CU FT	① Model	List Price
Coffee Table	36	36	16	46	16	OCFT7336-16	\$1,801

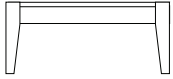

· 1/2" thick glass

Coffee Table	30	30	16	38	11	OCFT7330-16	\$1,670
--------------	----	----	----	----	----	-------------	---------



· 1/2" thick glass

Coffee Table	22	42	16	75	11	OCFT7342-16	\$1,664
--------------	----	----	----	----	----	-------------	---------



· 1/2" thick glass

Console Table	15	48	29	72	16	OCST7348-29	\$1,626
---------------	----	----	----	----	----	-------------	---------



· 1/2" thick glass

End Table	22	30	24	49	12	OET7330-24	\$1,384
-----------	----	----	----	----	----	------------	---------

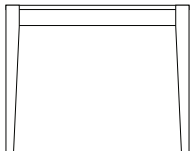

· 1/2" thick glass

End Table	22	22	24	49	9	OST7322-24	\$1,231
-----------	----	----	----	----	---	------------	---------

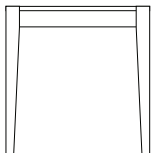

· 1/2" thick glass

To Order, Specify:

- ① Model Number
- ② Wood Species - Maple (M)
- ③ Wood Finish

③ Wood Finish Options:

ALE Ale	FLX Flax
AUB Auburn	LGC Legacy
AUT Autumn	MCH Mocha
BRL Barley	NTO Night Owl
BBN Bourbon	PRL Praline
BRG Brighton	SAF Saffron
BUT Butterscotch	SIE Sienna
CIN Cinnamon	TOF Toffee
CLA Classic	TRF Truffle
EAR Earthy	VEN Venetian
ESP Espresso	

Specifications

- Frame is hardwood maple.
- Frosted glass tops with screen print on underside with finger print resistant coating.
- Glass is tempered.

LOUNGE

Ziva Lounge Order Check List:



Specify:

- 1. Model Number
- 2. Fabric Selection - vendor, pattern and color

Example:

ZV6665 (model #)	MOMENTUM (fabric vendor)	VOX (pattern name)	MYSTIC (pattern color)
----------------------------	------------------------------------	------------------------------	----------------------------------

1. Model number

2. Fabric selection - Please supply the following:

- Fabric vendor
- Pattern name
- Pattern color

When specifying contrasting upholstery complete the form on page 7. Use higher grade pricing.

- Fabric for Ziva is always railroaded
- Please provide illustration, if available

All COM orders must include the following:

- Vendor's name, pattern name and color
- Sample of the fabric attached to the order
- Model numbers of items for fabric application
- Special application instructions (e.g., all stripes will be applied front to back unless specified otherwise)
- Customer and purchase order number

Ship prepaid COM material to:
 JSI
 Attn: COM Dept
 932 Mill Street
 Jasper, IN 47546

Application of fabric:
 Railroaded

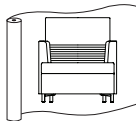

All COM orders will ship at standard lead time from receipt of COM except for orders requiring special custom matched finishes.

Ziva Tables Order Check List:



Specify:

- 1. Model Number
- 2. Top Material - Veneer or Glacier White Solid Surface
- 3. Wood Species - Cherry (CH1), Maple (MA1) or Walnut (WA1)
- 4. Wood Finish

Example:

OCFT6648-18 (model #)	Veneer (top material)	WA1 (wood species)	AUB (wood finish)
---------------------------------	---------------------------------	------------------------------	-----------------------------

1. Model Number

2. Top Material - Veneer or Glacier White Solid Surface

3. Wood Species - Cherry (CH1), Maple (MA1) or Walnut (WA1)

4. Wood Finish Options:

Cherry - Flat Cut

- AUT Autumn
- BRL Barley
- BBN Bourbon
- BRG Brighton
- CLA Classic
- EAR Earthy
- LGC Legacy
- PRL Praline
- SAF Saffron

Maple - Flat Cut

- ALE Ale
- BUT Butterscotch
- CIN Cinnamon
- FLX Flax
- VEN Venetian

Walnut - Flat Cut

- AUB Auburn
- ESP Espresso
- MCH Mocha
- NTO Night Owl
- SIE Sienna
- TOF Toffee
- TRF Truffle

Overview

Ziva is a comprehensive collection of freestanding and configurable seating with an offering of occasional and work tables.

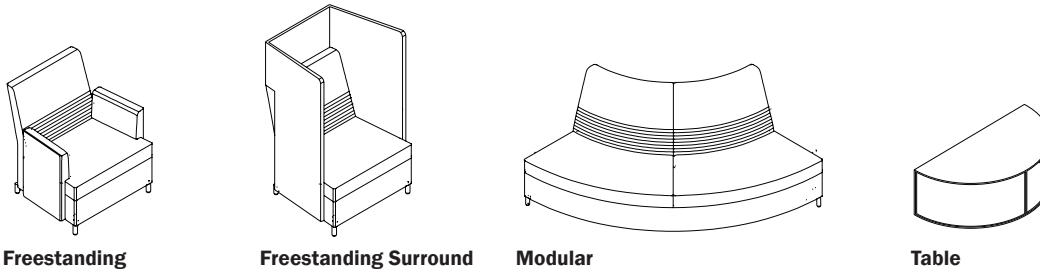

Freestanding

Freestanding Surround

Modular

Table

Features

Functional details are integrated into the high design of Ziva. The linear stitch pattern in the lumbar area creates interest, while adding comfort. End and middle arm options allow for optional tablet. The custom foot allows for leveling and supports the caster option, if mobility is needed.

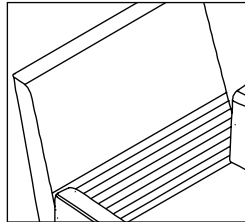

Lumbar Support

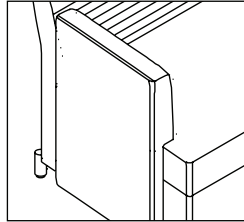

End Arm

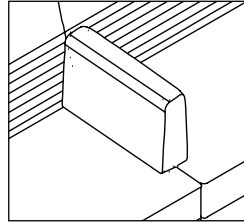

Middle Arm

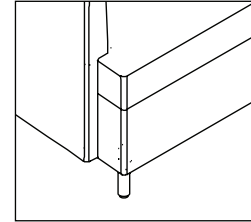

Foot with Leveler

Stand Alone Options

The freestanding units come with a variety of options. The front casters and back handle on the single seat provides for mobility. An upper privacy surround on the single or two seater has acoustical capabilities, creating visual and audible privacy for the seated user.

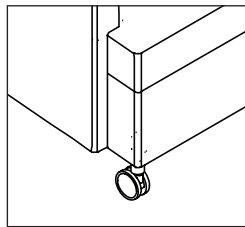

Front Casters

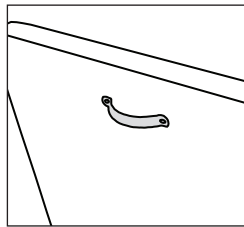

Pull on Outside Back

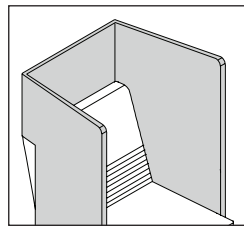

Privacy Surround

Ziva's stand alone lounge may be specified with a Black (B) or White (W) power outlet on the side, in the arm, or the privacy surround. The unit has two 120 volt outlets and two USB power outlets capable of powering two small devices. The fourth section is open and can be field fitted with a custom selected port.

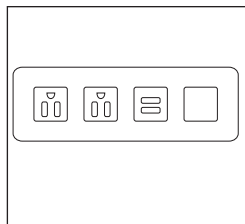

Power Outlet

2- 120 volt
2- USB Power

Configurable

Ziva's modular lounge is comprised of wedge and quarter round units in addition to three sizes of in-line units. The backs on the round units are offered on the inside or outside to allow for concave or convex configurations. Modular bench, available in round or in-line, enhance the layout possibilities while creating an open plan solution.

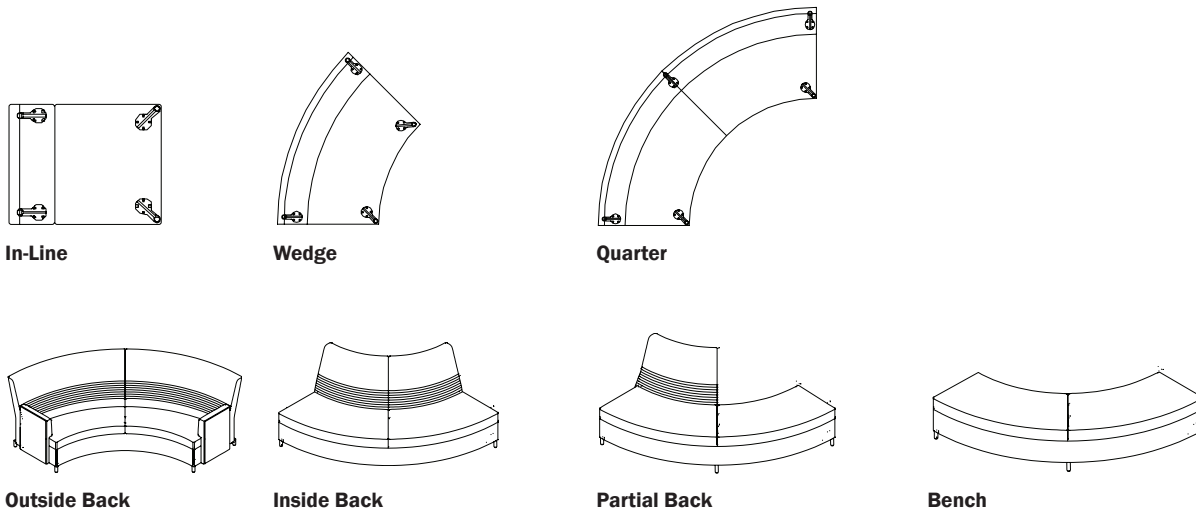

Recommended Combinations

Ziva is designed to fit the user's preference. To uphold the design statement of Ziva, it is recommended that adjacent layouts have backs on the same side (*example 1 & 2*) or attached to a bench (*example 3*). Opposite facing configurations may be achieved by placing a bench or benches in between the two directions (*example 4*).

LOUNGE

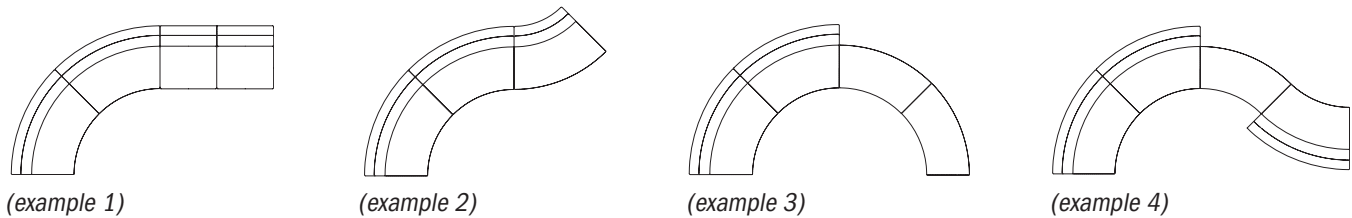

Ottomans and Tables

Ottomans and tables can complete a layout and provide functionality. The ottomans are available in three diameters.

The light scale tables have an Arctic Silver powder coat frame with wood or optional Glacier White solid surface top. The versatile work height tables serve as an end table and arm rest. They can be positioned over benches or the seated user to be used as a work surface. Tables are available in square, rectangle, or half round. They are designed to be used individually or paired up with a matching table.

Both the ottoman or the half round coffee table fit perfectly inside round configurations.

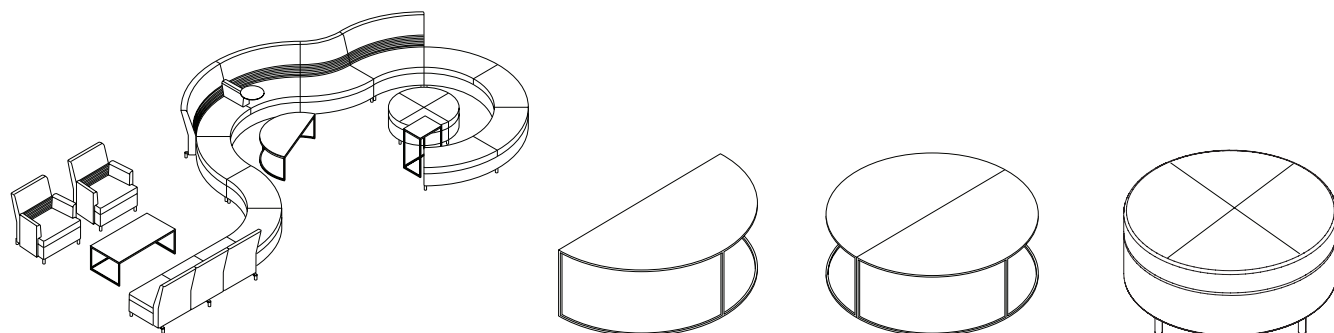

End Arm

Units which are armless on one or both sides may be specified with an optional end arm. Information for the optional arm is listed on page 418. When available, it is best to specify a model number that includes arms instead of adding the arms as an option. **Arms cannot be field installed.**

End arms are factory installed when ordered with a unit. Once an arm is attached, removal is not recommended due to boring holes in the upholstery.

Below are recommendations for the end arm.

Note: Arm can only be mounted on the side of a unit with a back.

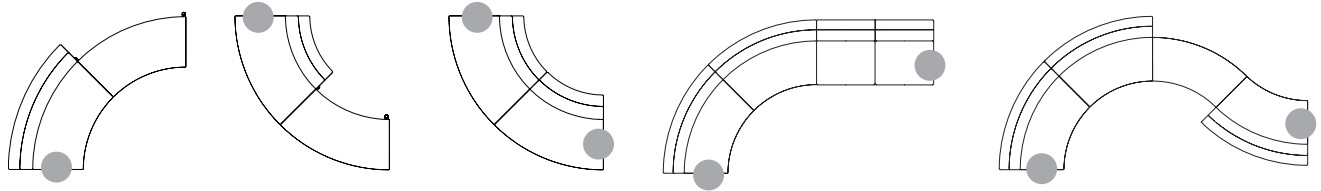

Middle Arms

Modular In-Line and Quarter Round units may be specified with a middle arm. Locations for the middle arm require two adjoining backs. Middle arms are not available between two separate units.

The middle arm is ordered as a separate line item option and pricing is listed on page 418. Optional middle arms must be factory installed.

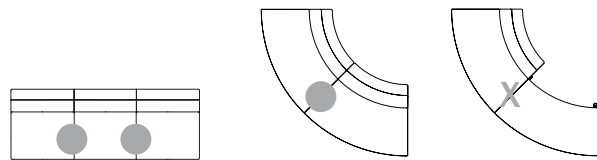

In-Line

Quarter Round

Tablet Table Option

All arms on freestanding and modular units are available with an optional 14" diameter tablet. It is offered in 3/4" thick wood or 1/2" thick Glacier White solid surface. The wood tablet is available in Cherry, Maple and Walnut.

The tablet is on a swivel mechanism allowing it to be placed closer to the user. The recommended weight limit for the tablet is 75lbs. JSI does not warrant any damage as a result of excessive weight.

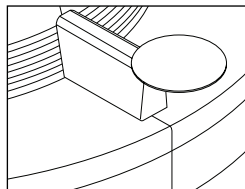

Tablet

(shown on a middle arm)

Glacier White - add \$331

Wood - add \$369

Lounge

Rights and Lefts

The handedness of the chair is determined by seated position.

Frame Construction

Frame interior is upholstery grade plywood with glued solid hardwood cross members reinforced with wood screws.

Seat Construction

Seat has synthetic sheet webbing with cross strap and 3 5/8" thick high resiliency polyurethane multi-density foam.

Back Construction

Back has 1 3/4" thick polyurethane foam, back lumbar has 10 channel stitch detail thru 3/8" thick polyurethane foam.

Arm Construction

3/4" of high grade polyurethane foam covers a plywood constructed arm frame.

Upholstery Detail

Contrasting fabric available on the back or the arms and seat.

Patterned fabric is not recommended as the fabric may not align at the same location.

Legs

Die cast zinc with matte chrome finish.
1" of height adjustability on the glide.

Tablet Arm

3/4" thick with Veneer or 1/2" thick Solid surface. Mechanism allows for a full 360 degree of swivel and writing surface of 14" diameter.

Tables

Frame Construction

Arctic Silver powder-coat finish over a fabricated and welded tubular frame.

Top Construction - Veneer

1.5 mm rimmed core with veneer surface.

Important Upholstery Information

To reduce the number of seams and to achieve a clean look, **Railroaded** off the roll application is standard for Ziva. Line art and pricing for Ziva reflects railroaded fabric. **Due to the size of Ziva and minimal seams, patterned fabrics with the nap (side to side), and leather are not recommended.**

JSI strives to achieve customer satisfaction, therefore requests for patterned fabrics, with a nap application, and leather will be reviewed on a case by case basis. Fill out the sample form on the next page and contact Customer Service. Additional fabric yardage may be required and will be the customer's responsibility. The customer may also be asked to approve additional seaming. Other additional charges may apply. If a patterned fabric is specified, JSI does not guarantee matching at seams.

Standard Seaming

The back and seat are upholstered separately and therefore will have no joining seams, only tailoring seams as per the product design. Shown below are examples of seams required to join the fabric on the seat and surround. (marked with a ●)

The seat seam is hidden on freestanding and modular units with full backs. Partial back modular units have seaming on the bench section on the same side as the back.

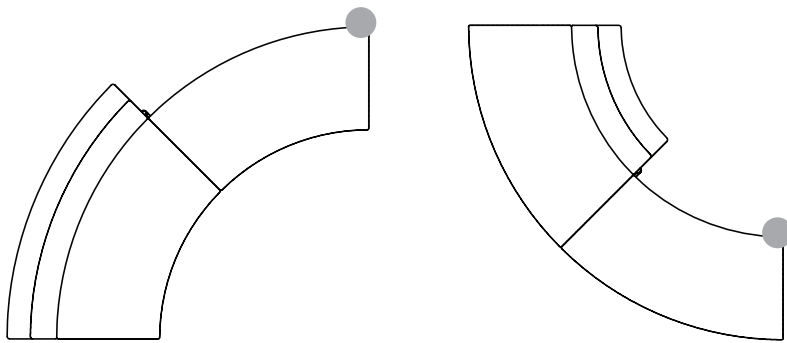

Benches (freestanding and modular) and ottomans have tailoring seams to align with the feet on the seat platform.

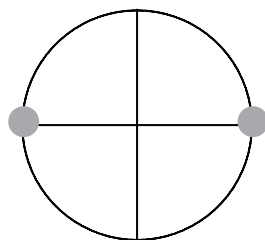
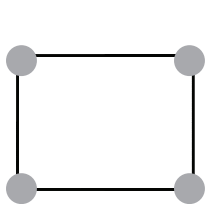

48" and 42"

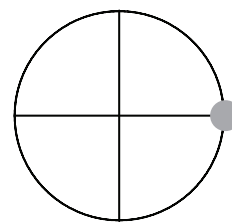

36"

Privacy Surround will have a fabric joining seam on the front band of surround.

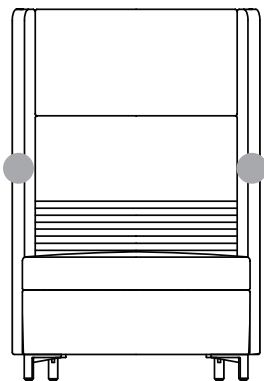

Seating Material Options

This form must accompany order when specifying contrasting or complementary upholstery.

Call for yardage and pricing.

Area (a), (b) and (c) are upholstery and can be specified in contrasting fabric. Legs and handle are a die-cast zinc with a matte chrome finish.

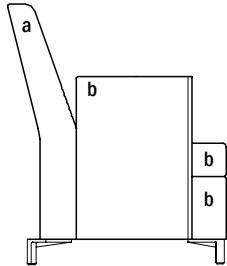

Freestanding & Modular

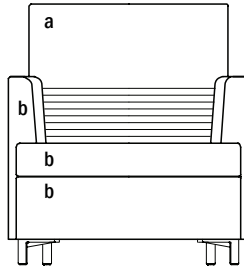

Model Number: _____

Back (a): _____

Arms, Seat & Base (b): _____

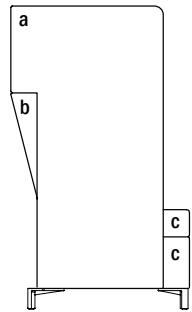

Freestanding with Surround

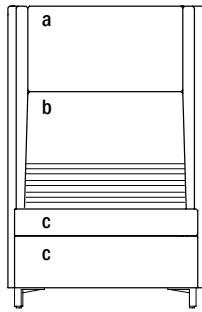

Model Number: _____

Surround (a): _____

Back (b): _____

Seat & Base (c): _____

photo copy or scan

Large Configurations

When using three or more modular units that will be connected as a single configuration, it is very helpful if the models and upholstery fabric are listed in sequence. This will assist in the order entry process and assure a better match of the configuration. Refer to the diagrams below.

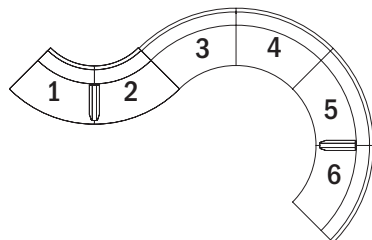
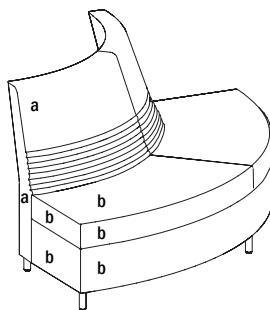

Sequence	Model #	Fabric a	Fabric b
1 of _____	_____	_____	_____
2 of _____	_____	_____	_____
3 of _____	_____	_____	_____
4 of _____	_____	_____	_____
5 of _____	_____	_____	_____
6 of _____	_____	_____	_____
7 of _____	_____	_____	_____
8 of _____	_____	_____	_____
9 of _____	_____	_____	_____

Typical Configurations

ZV001

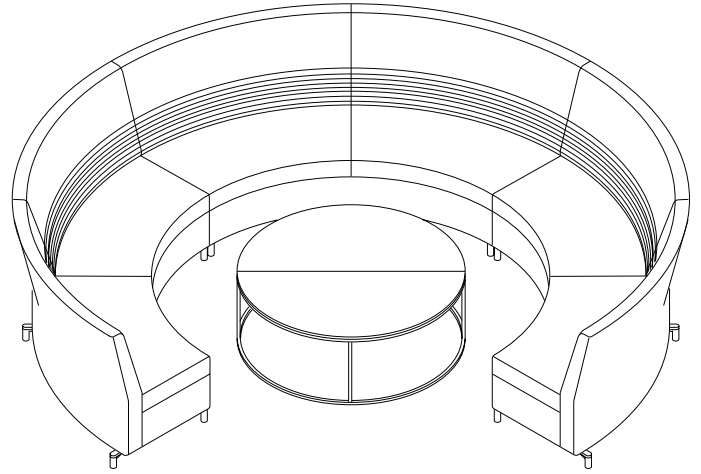
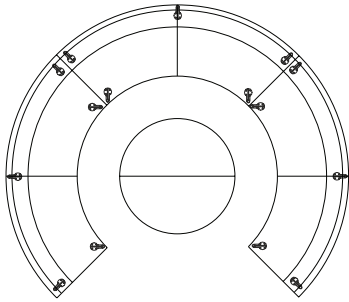

Total List \$13,269

Models

- (3) ZV6688-F0B
- (2) ORCT6648-24-18

Quarter Round with Outside Back
Half Round Table with Glacier White Solid Surface

ZV002

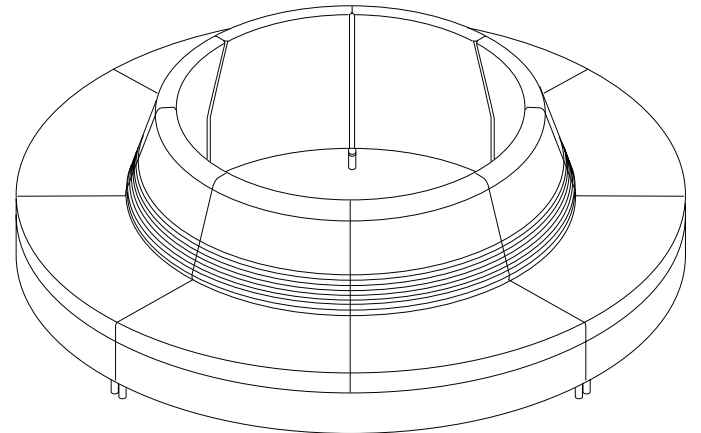
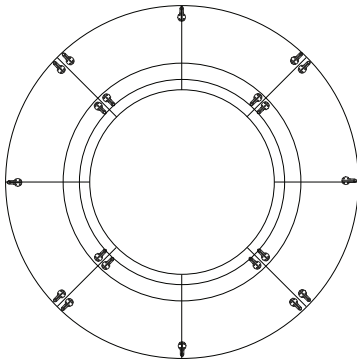

Total List \$13,412

Models

- (4) ZV6688-F1B

Quarter Round with Inside Back

Typical Configurations

ZV003

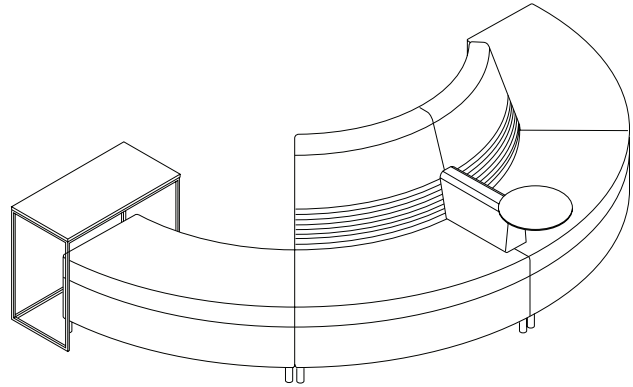
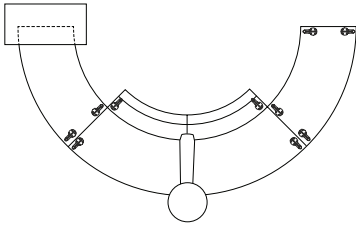

Total List \$7,727

Models

- | | |
|-----------------|--|
| (1) ZV6688-FIB | Quarter Round with Inside Back with Middle Arm and Wood Tablet ▲ |
| (2) ZV6647▲ | Wedge Bench |
| (1) ORWT6630-26 | 30" Work Height Table with Glacier White Solid Surface |

ZV004

LOUNGE

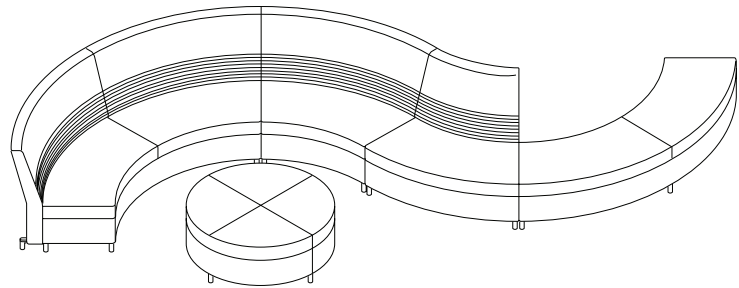
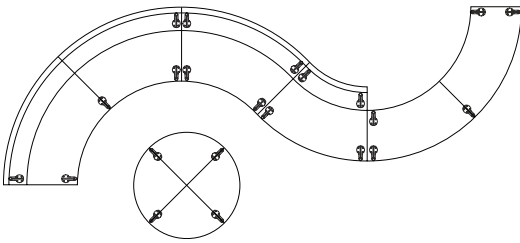

Total List \$10,661

Models

- | | |
|----------------|---------------------------------|
| (1) ZV6688-FOB | Quarter Round with Outside Back |
| (1) ZV6650-OB | Wedge with Outside Back |
| (1) ZV6651-IB | Wedge with Inside Back |
| (1) ZV6688 | Quarter Round Bench |
| (1) ZV6642 | 42" Ottoman |

Typical Configurations

ZV005

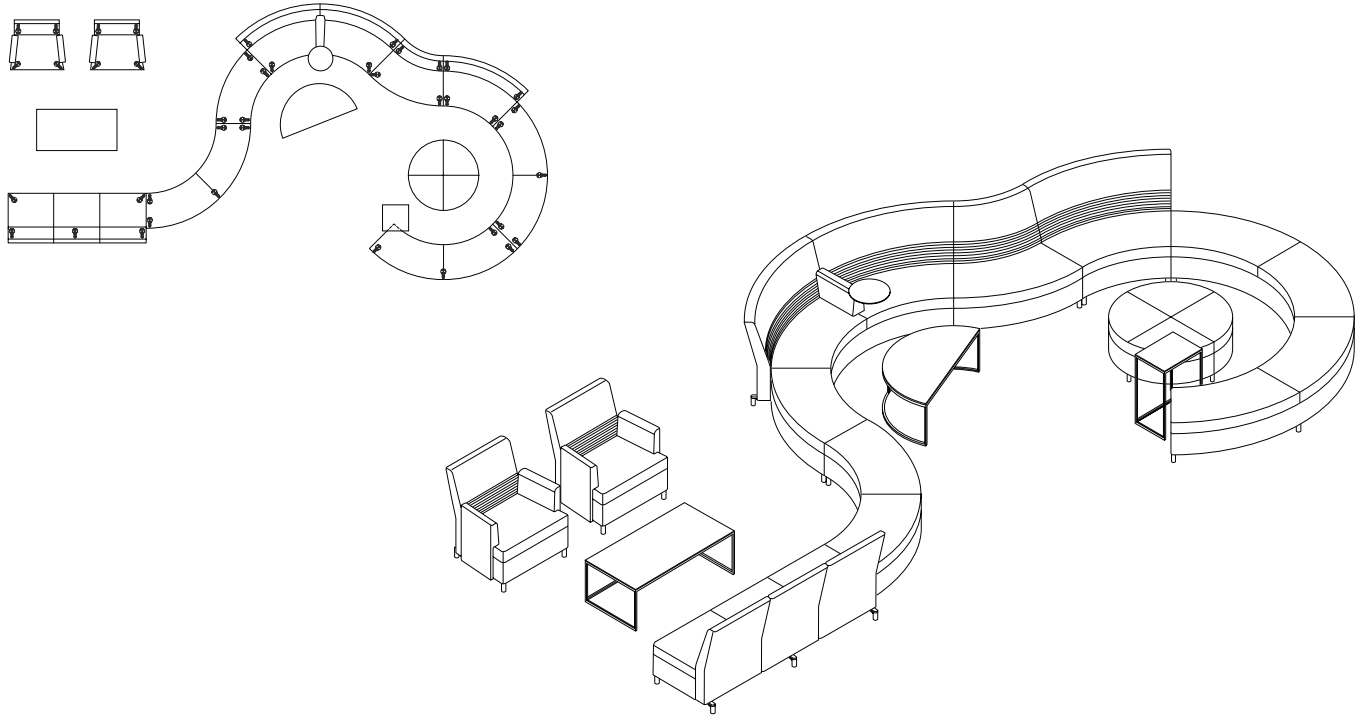



Total List \$27,990 ▲

Models

(2) ZV6665	Single Seat
(1) OCFT6648-18	48" W Coffee Table with Glacier White Solid Surface
▲(1) ZV6683-FB	In-Line Three Seat
(1) ZV6688	Quarter Round Bench
(1) ZV6647	Wedge Bench
(1) ZV6688-FOB	Quarter Round with Outside Back with optional Middle Arm
(1) ZV6651-IB	Wedge with Inside Back
(1) ZV6650-OB	Wedge with Outside Back
(2) ZV6688	Quarter Round Bench
(1) ZV6648	48" Ottoman
(1) ORCT6648-24-18	Half Round Table with Glacier White Solid Surface
(1) OST6615-26	Work Height Table with Glacier White Solid Surface

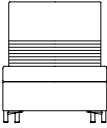
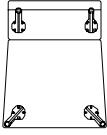
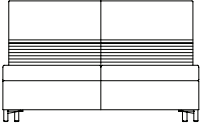
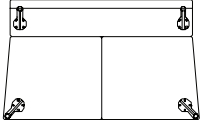
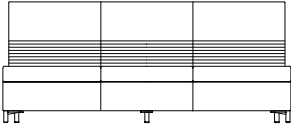
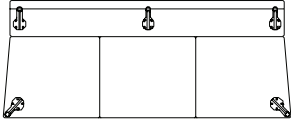
FREESTANDING

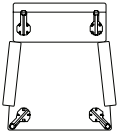
Description	① Model	Specifications	List Price Per Grade																												
Single Seat  	ZV6660 · upholstered seat and back · armless · front casters and pull available, specify and add \$99 list · power unit available, specify and add \$731 list; indicate right or left as seated and color Black (B) or White (W) · fabric application is railroaded	<table border="1"> <thead> <tr> <th>Dimensions</th> <th>D</th> <th>W</th> <th>H</th> </tr> </thead> <tbody> <tr> <td>Overall</td> <td>30 3/8</td> <td>31</td> <td>36</td> </tr> <tr> <td>Seat</td> <td>20 1/2</td> <td>29 3/8</td> <td>17 1/2</td> </tr> </tbody> </table>	Dimensions	D	W	H	Overall	30 3/8	31	36	Seat	20 1/2	29 3/8	17 1/2	<table border="1"> <thead> <tr> <th colspan="2">Upholstery</th> <th colspan="2">Shipping</th> </tr> </thead> <tbody> <tr> <td>COM Ydg</td> <td>3 1/2</td> <td>Ctn Wt</td> <td>82</td> </tr> <tr> <td></td> <td></td> <td>Cu Ft</td> <td>23</td> </tr> </tbody> </table>	Upholstery		Shipping		COM Ydg	3 1/2	Ctn Wt	82			Cu Ft	23				
		Dimensions	D	W	H																										
Overall	30 3/8	31	36																												
Seat	20 1/2	29 3/8	17 1/2																												
Upholstery		Shipping																													
COM Ydg	3 1/2	Ctn Wt	82																												
		Cu Ft	23																												
<table border="1"> <tbody> <tr> <td>COM</td> <td>\$1,449</td> </tr> <tr> <td>A</td> <td>\$1,481</td> </tr> <tr> <td>B</td> <td>\$1,542</td> </tr> <tr> <td>C</td> <td>\$1,648</td> </tr> <tr> <td>D</td> <td>\$1,784</td> </tr> <tr> <td>E</td> <td>\$1,921</td> </tr> <tr> <td>F</td> <td>\$2,066</td> </tr> <tr> <td>G</td> <td>\$2,271</td> </tr> <tr> <td>H</td> <td>\$2,490</td> </tr> <tr> <td>I</td> <td>\$2,832</td> </tr> <tr> <td>J</td> <td>\$3,243</td> </tr> </tbody> </table>	COM	\$1,449	A	\$1,481	B	\$1,542	C	\$1,648	D	\$1,784	E	\$1,921	F	\$2,066	G	\$2,271	H	\$2,490	I	\$2,832	J	\$3,243									
COM	\$1,449																														
A	\$1,481																														
B	\$1,542																														
C	\$1,648																														
D	\$1,784																														
E	\$1,921																														
F	\$2,066																														
G	\$2,271																														
H	\$2,490																														
I	\$2,832																														
J	\$3,243																														
Two Seat  	ZV6670 · upholstered seat and back · armless · power unit available, specify and add \$731 list; indicate right or left as seated and color Black (B) or White (W) · fabric application is railroaded	<table border="1"> <thead> <tr> <th>Dimensions</th> <th>D</th> <th>W</th> <th>H</th> </tr> </thead> <tbody> <tr> <td>Overall</td> <td>30 3/8</td> <td>58 1/2</td> <td>36</td> </tr> <tr> <td>Seat</td> <td>20 1/2</td> <td>56 3/4</td> <td>17 1/2</td> </tr> </tbody> </table>	Dimensions	D	W	H	Overall	30 3/8	58 1/2	36	Seat	20 1/2	56 3/4	17 1/2	<table border="1"> <thead> <tr> <th colspan="2">Upholstery</th> <th colspan="2">Shipping</th> </tr> </thead> <tbody> <tr> <td>COM Ydg</td> <td>7</td> <td>Ctn Wt</td> <td>154</td> </tr> <tr> <td></td> <td></td> <td>Cu Ft</td> <td>42</td> </tr> </tbody> </table>	Upholstery		Shipping		COM Ydg	7	Ctn Wt	154			Cu Ft	42				
		Dimensions	D	W	H																										
Overall	30 3/8	58 1/2	36																												
Seat	20 1/2	56 3/4	17 1/2																												
Upholstery		Shipping																													
COM Ydg	7	Ctn Wt	154																												
		Cu Ft	42																												
<table border="1"> <tbody> <tr> <td>COM</td> <td>\$2,429</td> </tr> <tr> <td>A</td> <td>\$2,491</td> </tr> <tr> <td>B</td> <td>\$2,613</td> </tr> <tr> <td>C</td> <td>\$2,825</td> </tr> <tr> <td>D</td> <td>\$3,099</td> </tr> <tr> <td>E</td> <td>\$3,372</td> </tr> <tr> <td>F</td> <td>\$3,662</td> </tr> <tr> <td>G</td> <td>\$4,071</td> </tr> <tr> <td>H</td> <td>\$4,509</td> </tr> <tr> <td>I</td> <td>\$5,194</td> </tr> <tr> <td>J</td> <td>\$6,015</td> </tr> </tbody> </table>	COM	\$2,429	A	\$2,491	B	\$2,613	C	\$2,825	D	\$3,099	E	\$3,372	F	\$3,662	G	\$4,071	H	\$4,509	I	\$5,194	J	\$6,015									
COM	\$2,429																														
A	\$2,491																														
B	\$2,613																														
C	\$2,825																														
D	\$3,099																														
E	\$3,372																														
F	\$3,662																														
G	\$4,071																														
H	\$4,509																														
I	\$5,194																														
J	\$6,015																														
Three Seat  	ZV6680 · upholstered seat and back · armless · power unit available, specify and add \$731 list; indicate right or left as seated and color Black (B) or White (W) · fabric application is railroaded	<table border="1"> <thead> <tr> <th>Dimensions</th> <th>D</th> <th>W</th> <th>H</th> </tr> </thead> <tbody> <tr> <td>Overall</td> <td>30 3/8</td> <td>86</td> <td>36</td> </tr> <tr> <td>Seat</td> <td>20 1/2</td> <td>84 3/8</td> <td>17 1/2</td> </tr> </tbody> </table>	Dimensions	D	W	H	Overall	30 3/8	86	36	Seat	20 1/2	84 3/8	17 1/2	<table border="1"> <thead> <tr> <th colspan="2">Upholstery</th> <th colspan="2">Shipping</th> </tr> </thead> <tbody> <tr> <td>COM Ydg</td> <td>10 1/2</td> <td>Ctn Wt</td> <td>224</td> </tr> <tr> <td></td> <td></td> <td>Cu Ft</td> <td>62</td> </tr> </tbody> </table>	Upholstery		Shipping		COM Ydg	10 1/2	Ctn Wt	224			Cu Ft	62				
		Dimensions	D	W	H																										
Overall	30 3/8	86	36																												
Seat	20 1/2	84 3/8	17 1/2																												
Upholstery		Shipping																													
COM Ydg	10 1/2	Ctn Wt	224																												
		Cu Ft	62																												
<table border="1"> <tbody> <tr> <td>COM</td> <td>\$3,649</td> </tr> <tr> <td>A</td> <td>\$3,742</td> </tr> <tr> <td>B</td> <td>\$3,924</td> </tr> <tr> <td>C</td> <td>\$4,244</td> </tr> <tr> <td>D</td> <td>\$4,654</td> </tr> <tr> <td>E</td> <td>\$5,064</td> </tr> <tr> <td>F</td> <td>\$5,497</td> </tr> <tr> <td>G</td> <td>\$6,113</td> </tr> <tr> <td>H</td> <td>\$6,770</td> </tr> <tr> <td>I</td> <td>\$7,796</td> </tr> <tr> <td>J</td> <td>\$9,027</td> </tr> </tbody> </table>	COM	\$3,649	A	\$3,742	B	\$3,924	C	\$4,244	D	\$4,654	E	\$5,064	F	\$5,497	G	\$6,113	H	\$6,770	I	\$7,796	J	\$9,027									
COM	\$3,649																														
A	\$3,742																														
B	\$3,924																														
C	\$4,244																														
D	\$4,654																														
E	\$5,064																														
F	\$5,497																														
G	\$6,113																														
H	\$6,770																														
I	\$7,796																														
J	\$9,027																														
Single Seat  	ZV6665 · upholstered seat, back and arms · front casters and pull available, specify and add \$99 list · tablet available, specify and add \$331 list for Glacier White or \$369 list for veneer; indicate right or left as seated and color · power unit available, specify and add \$731 list; indicate right or left as seated and color Black (B) or White (W) · fabric application is railroaded	<table border="1"> <thead> <tr> <th>Dimensions</th> <th>D</th> <th>W</th> <th>H</th> </tr> </thead> <tbody> <tr> <td>Overall</td> <td>30 3/8</td> <td>33 3/8</td> <td>36</td> </tr> <tr> <td>Seat</td> <td>20 1/2</td> <td>24 1/4</td> <td>17 1/2</td> </tr> <tr> <td>Arm</td> <td></td> <td></td> <td>26</td> </tr> </tbody> </table>	Dimensions	D	W	H	Overall	30 3/8	33 3/8	36	Seat	20 1/2	24 1/4	17 1/2	Arm			26	<table border="1"> <thead> <tr> <th colspan="2">Upholstery</th> <th colspan="2">Shipping</th> </tr> </thead> <tbody> <tr> <td>COM Ydg</td> <td>5</td> <td>Ctn Wt</td> <td>97</td> </tr> <tr> <td></td> <td></td> <td>Cu Ft</td> <td>24</td> </tr> </tbody> </table>	Upholstery		Shipping		COM Ydg	5	Ctn Wt	97			Cu Ft	24
		Dimensions	D	W	H																										
Overall	30 3/8	33 3/8	36																												
Seat	20 1/2	24 1/4	17 1/2																												
Arm			26																												
Upholstery		Shipping																													
COM Ydg	5	Ctn Wt	97																												
		Cu Ft	24																												
<table border="1"> <tbody> <tr> <td>COM</td> <td>\$1,851</td> </tr> <tr> <td>A</td> <td>\$1,895</td> </tr> <tr> <td>B</td> <td>\$1,982</td> </tr> <tr> <td>C</td> <td>\$2,134</td> </tr> <tr> <td>D</td> <td>\$2,329</td> </tr> <tr> <td>E</td> <td>\$2,525</td> </tr> <tr> <td>F</td> <td>\$2,730</td> </tr> <tr> <td>G</td> <td>\$3,024</td> </tr> <tr> <td>H</td> <td>\$3,336</td> </tr> <tr> <td>I</td> <td>\$3,826</td> </tr> <tr> <td>J</td> <td>\$4,412</td> </tr> </tbody> </table>	COM	\$1,851	A	\$1,895	B	\$1,982	C	\$2,134	D	\$2,329	E	\$2,525	F	\$2,730	G	\$3,024	H	\$3,336	I	\$3,826	J	\$4,412									
COM	\$1,851																														
A	\$1,895																														
B	\$1,982																														
C	\$2,134																														
D	\$2,329																														
E	\$2,525																														
F	\$2,730																														
G	\$3,024																														
H	\$3,336																														
I	\$3,826																														
J	\$4,412																														

LOUNGE

FREESTANDING

Description

1 Model

Specifications

List Price Per Grade

Two Seat

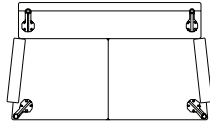
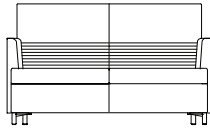

ZV6675

- upholstered seat, back and arms
- tablet available, specify and add \$331 list for Glacier White or \$369 list for veneer; indicate right or left as seated
- power unit available, specify and add \$731 list; indicate right or left as seated and color Black (B) or White (W)
- fabric application is railroaded

Dimensions	D	W	H
Overall	30 3/8	60 3/4	36
Seat	20 1/2	51 3/4	17 1/2
Arm			26
Upholstery		Shipping	
COM Ydg	8 1/2	Ctn Wt	198
		Cu Ft	44

COM	\$2,885
A	\$2,959
B	\$3,107
C	\$3,366
D	\$3,698
E	\$4,030
F	\$4,381
G	\$4,880
H	\$5,411
I	\$6,242
J	\$7,239

Three Seat

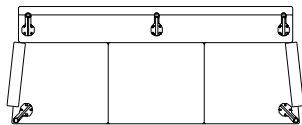
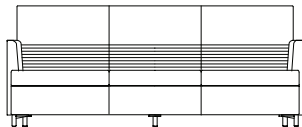

ZV6685

- upholstered seat, back and arms
- tablet available, specify and add \$331 list for Glacier White or \$369 list for veneer; indicate right or left as seated
- power unit available, specify and add \$731 list; indicate right or left as seated and color Black (B) or White (W)
- fabric application is railroaded

Dimensions	D	W	H
Overall	30 3/8	88 1/4	36
Seat	20 1/2	79 1/4	17 1/2
Arm			26
Upholstery		Shipping	
COM Ydg	12	Ctn Wt	258
		Cu Ft	63

COM	\$4,116
A	\$4,221
B	\$4,430
C	\$4,795
D	\$5,264
E	\$5,733
F	\$6,228
G	\$6,933
H	\$7,682
I	\$8,855
J	\$10,263

To Order, Specify:

- 1** Model Number
- 2** Fabric Selection - vendor, pattern and color

- 2** See a selection of graded in fabric manufacturers and patterns on pages 12-20. Contact Customer Service for additional fabric options.

Specifications

- Fabric is railroaded.
- Non-patterned textile is recommended.
- Frame interior is upholstery grade plywood with glued solid hardwood cross members reinforced with wood screws.
- Seat has synthetic sheet webbing with cross strap and 3 5/8" thick high resiliency seat polyurethane multi-density foam.
- Back has 1 3/4" thick polyurethane foam, back lumbar has 10 channel stitch detail thru 3/8" thick polyurethane foam.
- 3/4" of high grade polyurethane foam covers a plywood constructed arm frame.

FREESTANDING

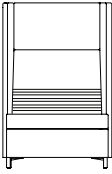
Description	① Model	Specifications			List Price Per Grade		
		Dimensions	D	W	H	COM	
Single Seat with Surround 	ZV6660-PS <ul style="list-style-type: none"> · upholstered seat, back and surround · front casters and pull available, specify and add \$99 list · power unit available, specify and add \$731 list; indicate right or left as seated and color Black (B) or White (W) · surround COM: 5 yds · fabric application is railroaded 	Overall	30 3/8	33 3/4	50 1/2	COM	\$2,362
		Seat	20 1/2	24 1/4	17 1/2	A	\$2,436
		Upholstery		Shipping		B	\$2,585
		COM Ydg	8 1/2	Ctn Wt	119	C	\$2,843
				Cu Ft	37	D	\$3,175
						E	\$3,507
						F	\$3,858
						G	\$4,357
						H	\$4,888
						I	\$5,719
						J	\$6,716

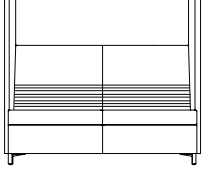
Description	① Model	Specifications			List Price Per Grade		
		Dimensions	D	W	H	COM	
Two Seat with Surround 	ZV6670-PS <ul style="list-style-type: none"> · upholstered seat, back and surround · power unit available, specify and add \$731 list; indicate right or left as seated and color Black (B) or White (W) · surround COM: 5 3/4 yds · fabric application is railroaded 	Overall	30 3/8	61 1/4	50 1/2	COM	\$3,159
		Seat	20 1/2	51 3/4	17 1/2	A	\$3,271
		Upholstery		Shipping		B	\$3,492
		COM Ydg	12 3/4	Ctn Wt	211	C	\$3,880
				Cu Ft	61	D	\$4,378
						E	\$4,877
						F	\$5,403
						G	\$6,150
						H	\$6,948
						I	\$8,194
						J	\$9,690

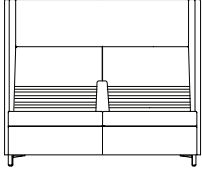
Description	① Model	Specifications			List Price Per Grade		
		Dimensions	D	W	H	COM	
Two Seat with Surround 	ZV6672-PS <ul style="list-style-type: none"> · upholstered seat, back and surround · middle arm · middle arm height - 26" · tablet available, specify and add \$331 list for Glacier White or \$369 list for veneer · power unit available, specify and add \$731 list; indicate right or left as seated and color Black (B) or White (W) · surround COM: 5 3/4 yds · fabric application is railroaded 	Overall	30 3/8	61 1/4	50 1/2	COM	\$3,331
		Seat	20 1/2	51 3/4	17 1/2	A	\$3,450
		Upholstery		Shipping		B	\$3,684
		COM Ydg	13 1/2	Ctn Wt	225	C	\$4,094
				Cu Ft	61	D	\$4,623
						E	\$5,150
						F	\$5,707
						G	\$6,499
						H	\$7,343
						I	\$8,662
						J	\$10,245

LOUNGE

FREESTANDING

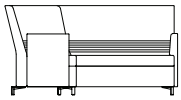
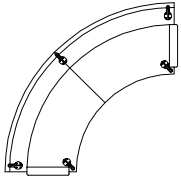
Description	Model	Specifications				List Price Per Grade	
		Dimensions	D	W	H	COM	
Quarter Round with Outside Back and Arms  	ZV6688-FOB-2A <ul style="list-style-type: none"> upholstered seat, back and arms tablet available for end arm, specify and add \$331 list for Glacier White or \$369 list for veneer; indicate right or left as seated power unit available, specify and add \$731 list; indicate right or left as seated and color Black (B) or White (W) middle arm available, see page 418 fabric application is railroaded. Non-patterned fabrics are recommended 	Overall	42 ½	101 ½	36	COM	\$3,885
		Seat	20 ½	59 ¼	17 ½	A	\$3,995
		Arm			26	B	\$4,212
		Upholstery		Shipping		C	\$4,592
		COM Ydg	12 ½	Ctn Wt	269	D	\$5,081
				Cu Ft	97	E	\$5,570
						F	\$6,085
						G	\$6,818
						H	\$7,600
						I	\$8,822
						J	\$10,288

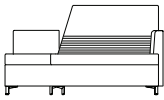
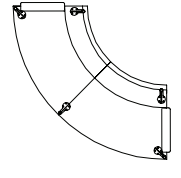
Description	Model	Specifications				List Price Per Grade	
		Dimensions	D	W	H	COM	
Quarter Round with Inside Back and Arms  	ZV6688-FIB-2A <ul style="list-style-type: none"> upholstered seat, back and arms tablet available for middle arm, specify and add \$331 list for Glacier White or \$369 list for veneer; indicate right or left as seated power unit available, specify and add \$731 list; indicate right or left as seated and color Black (B) or White (W) middle arm available, see page 418 fabric application is railroaded. Non-patterned fabrics are recommended 	Overall	39 ½	87 ⅝	36	COM	\$3,827
		Seat	20 ½	45 ⅝	17 ½	A	\$3,910
		Arm			26	B	\$4,076
		Upholstery		Shipping		C	\$4,364
		COM Ydg	9 ½	Ctn Wt	254	D	\$4,735
				Cu Ft	81	E	\$5,107
						F	\$5,498
						G	\$6,056
						H	\$6,650
						I	\$7,578
						J	\$8,692

To Order, Specify:

- ① Model Number
- ② Fabric Selection - vendor, pattern and color

- ② See a selection of graded in fabric manufacturers and patterns on pages 12-20. Contact Customer Service for additional fabric options.

Specifications

- Fabric is railroaded.
- Non-patterned textile is recommended.
- Frame interior is upholstery grade plywood with glued solid hardwood cross members reinforced with wood screws.
- Seat has synthetic sheet webbing with cross strap and 3 ⅝" thick high resiliency seat polyurethane multi-density foam.
- Back has 1 ¾" thick polyurethane foam, back lumbar has 10 channel stitch detail thru ¾" thick polyurethane foam.
- ¾" of high grade polyurethane foam covers a plywood constructed arm frame.

MODULAR

Description

① Model

Specifications

List Price Per Grade

In-Line Single Seat

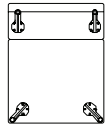

ZV6628-FB

- upholstered seat and back
- armless
- end arm available, see page 418
- power unit available, specify and add \$731 list; indicate right or left as seated and color Black (B) or White (W)
- fabric application is railroaded. Non-patterned fabrics are recommended

Dimensions	D	W	H
Overall	30 3/8	27 1/2	36
Seat	20 1/2	27 1/2	17 1/2
Upholstery		Shipping	
COM Ydg	3 1/2	Ctn Wt	82
		Cu Ft	20

COM	\$1,404
A	\$1,436
B	\$1,497
C	\$1,603
D	\$1,739
E	\$1,876
F	\$2,021
G	\$2,225
H	\$2,445
I	\$2,787
J	\$3,198

In-Line Two Seat

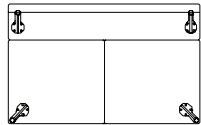
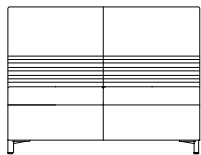

ZV6655-FB

- upholstered seat and back
- armless
- end arm available, see page 418
- power unit available, specify and add \$731 list; indicate right or left as seated and color Black (B) or White (W)
- fabric application is railroaded. Non-patterned fabrics are recommended

Dimensions	D	W	H
Overall	30 3/8	55	36
Seat	20 1/2	55 1/8	17 1/2
Upholstery		Shipping	
COM Ydg	7	Ctn Wt	154
		Cu Ft	40

COM	\$2,457
A	\$2,519
B	\$2,641
C	\$2,853
D	\$3,127
E	\$3,400
F	\$3,690
G	\$4,100
H	\$4,538
I	\$5,222
J	\$6,043

In-Line Three Seat

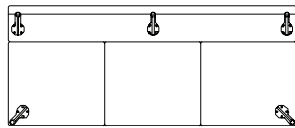
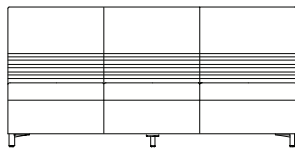

ZV6683-FB

- upholstered seat and back
- armless
- end or middle arm available, see page 418
- power unit available, specify and add \$731 list; indicate right or left as seated and color Black (B) or White (W)
- fabric application is railroaded. Non-patterned fabrics are recommended

Dimensions	D	W	H
Overall	30 3/8	82 1/2	36
Seat	20 1/2	82 5/8	17 1/2
Upholstery		Shipping	
COM Ydg	10 1/2	Ctn Wt	224
		Cu Ft	59

COM	\$3,747
A	\$3,839
B	\$4,022
C	\$4,341
D	\$4,752
E	\$5,161
F	\$5,595
G	\$6,210
H	\$6,867
I	\$7,893
J	\$9,125

Wedge with Outside Back

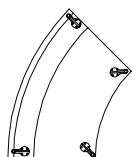
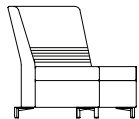

ZV6650-OB

- upholstered seat and back
- armless
- end arm available, see page 418
- power unit available, specify and add \$731 list; indicate right or left as seated and color Black (B) or White (W)
- fabric application is railroaded. Non-patterned fabrics are recommended

Dimensions	D	W	H
Overall	33 1/2	54 7/8	36
Seat	20 1/2	31 1/8	17 1/2
Upholstery		Shipping	
COM Ydg	5 1/2	Ctn Wt	129
		Cu Ft	44

COM	\$1,881
A	\$1,929
B	\$2,025
C	\$2,193
D	\$2,407
E	\$2,622
F	\$2,849
G	\$3,171
H	\$3,516
I	\$4,053
J	\$4,698

Description	① Model	Specifications			List Price Per Grade		
		Dimensions	D	W	H	COM	
Quarter Round with Partial Outside Back	ZV6688-ROB ZV6688-LOB <ul style="list-style-type: none"> · upholstered seat and back · armless · end arm available, see page 418 · power unit available, specify and add \$731 list; indicate right or left as seated and color Black (B) or White (W) · fabric application is railroaded. Non-patterned fabrics are recommended 	Overall	42 ½	94 ¾	36	COM	\$2,687
		Seat	20 ½	59 ¼	17 ½	A	\$2,749
		Upholstery		Shipping		B	\$2,871
		COM Ydg	7	Ctn Wt	231	C	\$3,083
				Cu Ft	92	D	\$3,357
						E	\$3,630
						F	\$3,920
						G	\$4,330
						H	\$4,767
						I	\$5,452
						J	\$6,273
Quarter Round with Outside Back	ZV6688-FOB <ul style="list-style-type: none"> · upholstered seat and back · armless · end or middle arm available, see page 418 · power unit available, specify and add \$731 list; indicate right or left as seated and color Black (B) or White (W) · fabric application is railroaded. Non-patterned fabrics are recommended 	Overall	42 ½	101 ½	36	COM	\$3,413
		Seat	20 ½	59 ¼	17 ½	A	\$3,510
		Upholstery		Shipping		B	\$3,701
		COM Ydg	11	Ctn Wt	190	C	\$4,036
				Cu Ft	100	D	\$4,465
						E	\$4,896
						F	\$5,349
						G	\$5,994
						H	\$6,682
						I	\$7,757
						J	\$9,047
Quarter Round with Outside Back	ZV6688-FOB-RA ZV6688-FOB-LA <ul style="list-style-type: none"> · upholstered seat, back and arm · tablet available for end arm, specify and add \$331 list for Glacier White or \$369 list for veneer · power unit available, specify and add \$731 list; indicate right or left as seated and color Black (B) or White (W) · fabric application is railroaded. Non-patterned fabrics are recommended 	Overall	42 ½	101 ½	36	COM	\$3,674
		Seat	20 ½	59 ¼	17 ½	A	\$3,777
		Arm			26	B	\$3,982
		Upholstery		Shipping		C	\$4,339
		COM Ydg	11 ¾	Ctn Wt	275	D	\$4,798
				Cu Ft	100	E	\$5,258
						F	\$5,743
						G	\$6,432
						H	\$7,167
						I	\$8,314
						J	\$9,693

To Order, Specify:



- ① Model Number
- ② Fabric Selection - vendor, pattern and color

- ② See a selection of graded in fabric manufacturers and patterns on pages 12-20. Contact Customer Service for additional fabric options.

Specifications

- Fabric is railroaded.
- Non-patterned textile is recommended.
- Frame interior is upholstery grade plywood with glued solid hardwood cross members reinforced with wood screws.
- Seat has synthetic sheet webbing with cross strap and 3 ¾" thick high resiliency seat polyurethane multi-density foam.
- Back has 1 ¾" thick polyurethane foam, back lumbar has 10 channel stitch detail thru ¾" thick polyurethane foam.
- ¾" of high grade polyurethane foam covers a plywood constructed arm frame.
- Linking bracket included.▲

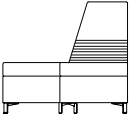
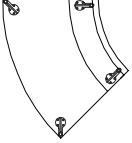
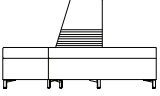
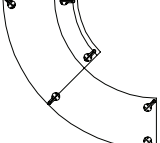
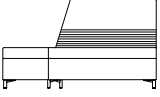
MODULAR

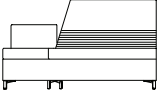
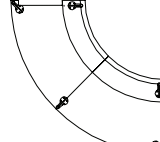
Description	① Model	Specifications	List Price Per Grade																																						
Wedge with Inside Back  	ZV6651-IB · upholstered seat and back · armless · end arm available, see page 418 · power unit available, specify and add \$731 list; indicate right or left as seated and color Black (B) or White (W) · fabric application is railroaded. Non-patterned fabrics are recommended	<table border="1"> <thead> <tr> <th>Dimensions</th> <th>D</th> <th>W</th> <th>H</th> </tr> </thead> <tbody> <tr> <td>Overall</td> <td>32 ¾</td> <td>47 ¾</td> <td>36</td> </tr> <tr> <td>Seat</td> <td>20 ½</td> <td>25 ⅞</td> <td>17 ½</td> </tr> </tbody> </table>	Dimensions	D	W	H	Overall	32 ¾	47 ¾	36	Seat	20 ½	25 ⅞	17 ½	<table border="1"> <thead> <tr> <th>COM</th> <th>\$1,853</th> </tr> </thead> <tbody> <tr><td>A</td><td>\$1,888</td></tr> <tr><td>B</td><td>\$1,958</td></tr> <tr><td>C</td><td>\$2,079</td></tr> <tr><td>D</td><td>\$2,236</td></tr> <tr><td>E</td><td>\$2,392</td></tr> <tr><td>F</td><td>\$2,557</td></tr> <tr><td>G</td><td>\$2,791</td></tr> <tr><td>H</td><td>\$3,041</td></tr> <tr><td>I</td><td>\$3,433</td></tr> <tr><td>J</td><td>\$3,902</td></tr> </tbody> </table>	COM	\$1,853	A	\$1,888	B	\$1,958	C	\$2,079	D	\$2,236	E	\$2,392	F	\$2,557	G	\$2,791	H	\$3,041	I	\$3,433	J	\$3,902				
		Dimensions	D	W	H																																				
Overall	32 ¾	47 ¾	36																																						
Seat	20 ½	25 ⅞	17 ½																																						
COM	\$1,853																																								
A	\$1,888																																								
B	\$1,958																																								
C	\$2,079																																								
D	\$2,236																																								
E	\$2,392																																								
F	\$2,557																																								
G	\$2,791																																								
H	\$3,041																																								
I	\$3,433																																								
J	\$3,902																																								
<table border="1"> <thead> <tr> <th>Upholstery</th> <th colspan="2">Shipping</th> </tr> </thead> <tbody> <tr> <td>COM Ydg</td> <td>4</td> <td>Ctn Wt 114</td> </tr> <tr> <td></td> <td></td> <td>Cu Ft 37</td> </tr> </tbody> </table>	Upholstery	Shipping		COM Ydg	4	Ctn Wt 114			Cu Ft 37																																
Upholstery	Shipping																																								
COM Ydg	4	Ctn Wt 114																																							
		Cu Ft 37																																							
Quarter Round with Partial Inside Back   right shown	ZV6688-RIB ZV6688-LIB · upholstered seat and back · armless · end arm available, see page 418 · power unit available, specify and add \$731 list; indicate right or left as seated and color Black (B) or White (W) · fabric application is railroaded. Non-patterned fabrics are recommended	<table border="1"> <thead> <tr> <th>Dimensions</th> <th>D</th> <th>W</th> <th>H</th> </tr> </thead> <tbody> <tr> <td>Overall</td> <td>39 ½</td> <td>87 ⅝</td> <td>36</td> </tr> <tr> <td>Seat</td> <td>20 ½</td> <td>52 ⅞</td> <td>17 ½</td> </tr> </tbody> </table>	Dimensions	D	W	H	Overall	39 ½	87 ⅝	36	Seat	20 ½	52 ⅞	17 ½	<table border="1"> <thead> <tr> <th>COM</th> <th>\$2,657</th> </tr> </thead> <tbody> <tr><td>A</td><td>\$2,705</td></tr> <tr><td>B</td><td>\$2,801</td></tr> <tr><td>C</td><td>\$2,969</td></tr> <tr><td>D</td><td>\$3,183</td></tr> <tr><td>E</td><td>\$3,398</td></tr> <tr><td>F</td><td>\$3,625</td></tr> <tr><td>G</td><td>\$3,947</td></tr> <tr><td>H</td><td>\$4,292</td></tr> <tr><td>I</td><td>\$4,829</td></tr> <tr><td>J</td><td>\$5,474</td></tr> </tbody> </table>	COM	\$2,657	A	\$2,705	B	\$2,801	C	\$2,969	D	\$3,183	E	\$3,398	F	\$3,625	G	\$3,947	H	\$4,292	I	\$4,829	J	\$5,474				
		Dimensions	D	W	H																																				
Overall	39 ½	87 ⅝	36																																						
Seat	20 ½	52 ⅞	17 ½																																						
COM	\$2,657																																								
A	\$2,705																																								
B	\$2,801																																								
C	\$2,969																																								
D	\$3,183																																								
E	\$3,398																																								
F	\$3,625																																								
G	\$3,947																																								
H	\$4,292																																								
I	\$4,829																																								
J	\$5,474																																								
<table border="1"> <thead> <tr> <th>Upholstery</th> <th colspan="2">Shipping</th> </tr> </thead> <tbody> <tr> <td>COM Ydg</td> <td>5 ½</td> <td>Ctn Wt 189</td> </tr> <tr> <td></td> <td></td> <td>Cu Ft 81</td> </tr> </tbody> </table>	Upholstery	Shipping		COM Ydg	5 ½	Ctn Wt 189			Cu Ft 81																																
Upholstery	Shipping																																								
COM Ydg	5 ½	Ctn Wt 189																																							
		Cu Ft 81																																							
Quarter Round with Inside Back   right shown	ZV6688-FIB · upholstered seat and back · armless · end or middle arm available, see page 418 · power unit available, specify and add \$731 list; indicate right or left as seated and color Black (B) or White (W) · fabric application is railroaded. Non-patterned fabrics are recommended	<table border="1"> <thead> <tr> <th>Dimensions</th> <th>D</th> <th>W</th> <th>H</th> </tr> </thead> <tbody> <tr> <td>Overall</td> <td>39 ½</td> <td>87 ⅝</td> <td>36</td> </tr> <tr> <td>Seat</td> <td>20 ½</td> <td>45 ⅝</td> <td>17 ½</td> </tr> </tbody> </table>	Dimensions	D	W	H	Overall	39 ½	87 ⅝	36	Seat	20 ½	45 ⅝	17 ½	<table border="1"> <thead> <tr> <th>COM</th> <th>\$3,353</th> </tr> </thead> <tbody> <tr><td>A</td><td>\$3,423</td></tr> <tr><td>B</td><td>\$3,562</td></tr> <tr><td>C</td><td>\$3,806</td></tr> <tr><td>D</td><td>\$4,119</td></tr> <tr><td>E</td><td>\$4,431</td></tr> <tr><td>F</td><td>\$4,761</td></tr> <tr><td>G</td><td>\$5,231</td></tr> <tr><td>H</td><td>\$5,730</td></tr> <tr><td>I</td><td>\$6,513</td></tr> <tr><td>J</td><td>\$7,451</td></tr> </tbody> </table>	COM	\$3,353	A	\$3,423	B	\$3,562	C	\$3,806	D	\$4,119	E	\$4,431	F	\$4,761	G	\$5,231	H	\$5,730	I	\$6,513	J	\$7,451				
		Dimensions	D	W	H																																				
Overall	39 ½	87 ⅝	36																																						
Seat	20 ½	45 ⅝	17 ½																																						
COM	\$3,353																																								
A	\$3,423																																								
B	\$3,562																																								
C	\$3,806																																								
D	\$4,119																																								
E	\$4,431																																								
F	\$4,761																																								
G	\$5,231																																								
H	\$5,730																																								
I	\$6,513																																								
J	\$7,451																																								
<table border="1"> <thead> <tr> <th>Upholstery</th> <th colspan="2">Shipping</th> </tr> </thead> <tbody> <tr> <td>COM Ydg</td> <td>8</td> <td>Ctn Wt 231</td> </tr> <tr> <td></td> <td></td> <td>Cu Ft 81</td> </tr> </tbody> </table>	Upholstery	Shipping		COM Ydg	8	Ctn Wt 231			Cu Ft 81																																
Upholstery	Shipping																																								
COM Ydg	8	Ctn Wt 231																																							
		Cu Ft 81																																							
Quarter Round with Inside Back   right shown	ZV6688-FIB-RA ZV6688-FIB-LA · upholstered seat, back and arm · tablet available for end arm, specify and add \$331 list for Glacier White or \$369 list for veneer · middle arm available, see page 418 · power unit available, specify and add \$731 list; indicate right or left as seated and color Black (B) or White (W) · fabric application is railroaded. Non-patterned fabrics are recommended	<table border="1"> <thead> <tr> <th>Dimensions</th> <th>D</th> <th>W</th> <th>H</th> </tr> </thead> <tbody> <tr> <td>Overall</td> <td>39 ½</td> <td>87 ⅝</td> <td>36</td> </tr> <tr> <td>Seat</td> <td>20 ½</td> <td>45 ⅝</td> <td>17 ½</td> </tr> <tr> <td>Arm</td> <td></td> <td></td> <td>26</td> </tr> </tbody> </table>	Dimensions	D	W	H	Overall	39 ½	87 ⅝	36	Seat	20 ½	45 ⅝	17 ½	Arm			26	<table border="1"> <thead> <tr> <th>COM</th> <th>\$3,615</th> </tr> </thead> <tbody> <tr><td>A</td><td>\$3,691</td></tr> <tr><td>B</td><td>\$3,843</td></tr> <tr><td>C</td><td>\$4,109</td></tr> <tr><td>D</td><td>\$4,451</td></tr> <tr><td>E</td><td>\$4,794</td></tr> <tr><td>F</td><td>\$5,155</td></tr> <tr><td>G</td><td>\$5,667</td></tr> <tr><td>H</td><td>\$6,215</td></tr> <tr><td>I</td><td>\$7,070</td></tr> <tr><td>J</td><td>\$8,096</td></tr> </tbody> </table>	COM	\$3,615	A	\$3,691	B	\$3,843	C	\$4,109	D	\$4,451	E	\$4,794	F	\$5,155	G	\$5,667	H	\$6,215	I	\$7,070	J	\$8,096
		Dimensions	D	W	H																																				
Overall	39 ½	87 ⅝	36																																						
Seat	20 ½	45 ⅝	17 ½																																						
Arm			26																																						
COM	\$3,615																																								
A	\$3,691																																								
B	\$3,843																																								
C	\$4,109																																								
D	\$4,451																																								
E	\$4,794																																								
F	\$5,155																																								
G	\$5,667																																								
H	\$6,215																																								
I	\$7,070																																								
J	\$8,096																																								
<table border="1"> <thead> <tr> <th>Upholstery</th> <th colspan="2">Shipping</th> </tr> </thead> <tbody> <tr> <td>COM Ydg</td> <td>8 ¾</td> <td>Ctn Wt 242</td> </tr> <tr> <td></td> <td></td> <td>Cu Ft 81</td> </tr> </tbody> </table>	Upholstery	Shipping		COM Ydg	8 ¾	Ctn Wt 242			Cu Ft 81																																
Upholstery	Shipping																																								
COM Ydg	8 ¾	Ctn Wt 242																																							
		Cu Ft 81																																							

LOUNGE

MODULAR

Description

1 Model

Specifications

List Price Per Grade

Single Seat Bench

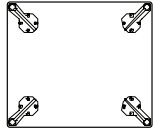
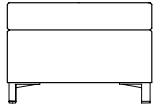

ZV6628

- upholstered seat
- power unit available, specify and add \$731 list; indicate right or left as seated and color Black (B) or White (W)
- fabric application is railroaded. Non-patterned fabrics are recommended

Dimensions	D	W	H
Overall	20 1/2	27 1/2	17 1/2
Upholstery		Shipping	
COM Ydg	2	Ctn Wt	50
		Cu Ft	7

COM	List Price
COM	\$1,150
A	\$1,168
B	\$1,203
C	\$1,264
D	\$1,342
E	\$1,420
F	\$1,503
G	\$1,620
H	\$1,745
I	\$1,941
J	\$2,175

Two Seat Bench

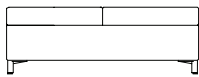

ZV6655

- upholstered seat
- power unit available, specify and add \$731 list; indicate right or left as seated and color Black (B) or White (W)
- fabric application is railroaded. Non-patterned fabrics are recommended

Dimensions	D	W	H
Overall	20 1/2	55	17 1/2
Upholstery		Shipping	
COM Ydg	4	Ctn Wt	73
		Cu Ft	14

COM	List Price
COM	\$1,953
A	\$1,989
B	\$2,058
C	\$2,180
D	\$2,337
E	\$2,493
F	\$2,658
G	\$2,892
H	\$3,142
I	\$3,534
J	\$4,003

To Order, Specify:



- 1** Model Number
- 2** Fabric Selection - vendor, pattern and color

- 2** See a selection of graded in fabric manufacturers and patterns on pages 12-20. Contact Customer Service for additional fabric options.

Specifications

- Fabric is railroaded.
- Non-patterned textile is recommended.
- Frame interior is upholstery grade plywood with glued solid hardwood cross members reinforced with wood screws.
- Seat has synthetic sheet webbing with cross strap and 3 5/8" thick high resiliency seat polyurethane multi-density foam.
- Back has 1 3/4" thick polyurethane foam, back lumbar has 10 channel stitch detail thru 3/8" thick polyurethane foam.
- 3/4" of high grade polyurethane foam covers a plywood constructed arm frame.
- Linking bracket included.▲

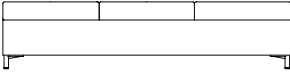
MODULAR

Description	① Model	Specifications	List Price Per Grade																																												
Three Seat Bench  	ZV6683 · upholstered seat · power unit available, specify and add \$731 list; indicate right or left as seated and color Black (B) or White (W) · fabric application is railroaded Non-patterned fabrics are recommended	<table border="1"> <thead> <tr> <th>Dimensions</th> <th>D</th> <th>W</th> <th>H</th> </tr> </thead> <tbody> <tr> <td>Overall</td> <td>20 ½</td> <td>82 ½</td> <td>17 ½</td> </tr> </tbody> </table>	Dimensions	D	W	H	Overall	20 ½	82 ½	17 ½	<table border="1"> <thead> <tr> <th>COM</th> <th>\$</th> <th>Grade</th> </tr> </thead> <tbody> <tr><td>COM</td><td>\$2,790</td><td></td></tr> <tr><td>A</td><td>\$2,843</td><td></td></tr> <tr><td>B</td><td>\$2,948</td><td></td></tr> <tr><td>C</td><td>\$3,129</td><td></td></tr> <tr><td>D</td><td>\$3,365</td><td></td></tr> <tr><td>E</td><td>\$3,599</td><td></td></tr> <tr><td>F</td><td>\$3,847</td><td></td></tr> <tr><td>G</td><td>\$4,198</td><td></td></tr> <tr><td>H</td><td>\$4,573</td><td></td></tr> <tr><td>I</td><td>\$5,160</td><td></td></tr> <tr><td>J</td><td>\$5,864</td><td></td></tr> </tbody> </table>	COM	\$	Grade	COM	\$2,790		A	\$2,843		B	\$2,948		C	\$3,129		D	\$3,365		E	\$3,599		F	\$3,847		G	\$4,198		H	\$4,573		I	\$5,160		J	\$5,864	
		Dimensions	D	W	H																																										
Overall	20 ½	82 ½	17 ½																																												
COM	\$	Grade																																													
COM	\$2,790																																														
A	\$2,843																																														
B	\$2,948																																														
C	\$3,129																																														
D	\$3,365																																														
E	\$3,599																																														
F	\$3,847																																														
G	\$4,198																																														
H	\$4,573																																														
I	\$5,160																																														
J	\$5,864																																														
		<table border="1"> <thead> <tr> <th>Upholstery</th> <th colspan="2">Shipping</th> </tr> </thead> <tbody> <tr> <td>COM Ydg</td> <td>6</td> <td>Ctn Wt 146</td> </tr> <tr> <td></td> <td></td> <td>Cu Ft 21</td> </tr> </tbody> </table>	Upholstery	Shipping		COM Ydg	6	Ctn Wt 146			Cu Ft 21																																				
Upholstery	Shipping																																														
COM Ydg	6	Ctn Wt 146																																													
		Cu Ft 21																																													

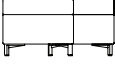
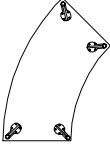
Wedge Bench  	ZV6647 · upholstered seat · power unit available, specify and add \$731 list; indicate right or left as seated and color Black (B) or White (W) · fabric application is railroaded Non-patterned fabrics are recommended	<table border="1"> <thead> <tr> <th>Dimensions</th> <th>D</th> <th>W</th> <th>H</th> </tr> </thead> <tbody> <tr> <td>Overall</td> <td>23 ¾</td> <td>47 ¾</td> <td>17 ½</td> </tr> </tbody> </table>	Dimensions	D	W	H	Overall	23 ¾	47 ¾	17 ½	<table border="1"> <thead> <tr> <th>COM</th> <th>\$</th> <th>Grade</th> </tr> </thead> <tbody> <tr><td>COM</td><td>\$1,210</td><td></td></tr> <tr><td>A</td><td>\$1,234</td><td></td></tr> <tr><td>B</td><td>\$1,283</td><td></td></tr> <tr><td>C</td><td>\$1,367</td><td></td></tr> <tr><td>D</td><td>\$1,474</td><td></td></tr> <tr><td>E</td><td>\$1,581</td><td></td></tr> <tr><td>F</td><td>\$1,694</td><td></td></tr> <tr><td>G</td><td>\$1,856</td><td></td></tr> <tr><td>H</td><td>\$2,028</td><td></td></tr> <tr><td>I</td><td>\$2,297</td><td></td></tr> <tr><td>J</td><td>\$2,619</td><td></td></tr> </tbody> </table>	COM	\$	Grade	COM	\$1,210		A	\$1,234		B	\$1,283		C	\$1,367		D	\$1,474		E	\$1,581		F	\$1,694		G	\$1,856		H	\$2,028		I	\$2,297		J	\$2,619	
		Dimensions	D	W	H																																										
Overall	23 ¾	47 ¾	17 ½																																												
COM	\$	Grade																																													
COM	\$1,210																																														
A	\$1,234																																														
B	\$1,283																																														
C	\$1,367																																														
D	\$1,474																																														
E	\$1,581																																														
F	\$1,694																																														
G	\$1,856																																														
H	\$2,028																																														
I	\$2,297																																														
J	\$2,619																																														
		<table border="1"> <thead> <tr> <th>Upholstery</th> <th colspan="2">Shipping</th> </tr> </thead> <tbody> <tr> <td>COM Ydg</td> <td>2 ¾</td> <td>Ctn Wt 57</td> </tr> <tr> <td></td> <td></td> <td>Cu Ft 14</td> </tr> </tbody> </table>	Upholstery	Shipping		COM Ydg	2 ¾	Ctn Wt 57			Cu Ft 14																																				
Upholstery	Shipping																																														
COM Ydg	2 ¾	Ctn Wt 57																																													
		Cu Ft 14																																													

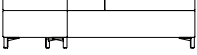
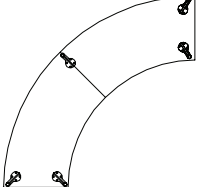
Quarter Round Bench  	ZV6688 · upholstered seat · power unit available, specify and add \$731 list; indicate right or left as seated and color Black (B) or White (W) · fabric application is railroaded Non-patterned fabrics are recommended	<table border="1"> <thead> <tr> <th>Dimensions</th> <th>D</th> <th>W</th> <th>H</th> </tr> </thead> <tbody> <tr> <td>Overall</td> <td>32 ¾</td> <td>87 ¾</td> <td>17 ½</td> </tr> </tbody> </table>	Dimensions	D	W	H	Overall	32 ¾	87 ¾	17 ½	<table border="1"> <thead> <tr> <th>COM</th> <th>\$</th> <th>Grade</th> </tr> </thead> <tbody> <tr><td>COM</td><td>\$2,134</td><td></td></tr> <tr><td>A</td><td>\$2,182</td><td></td></tr> <tr><td>B</td><td>\$2,278</td><td></td></tr> <tr><td>C</td><td>\$2,446</td><td></td></tr> <tr><td>D</td><td>\$2,660</td><td></td></tr> <tr><td>E</td><td>\$2,875</td><td></td></tr> <tr><td>F</td><td>\$3,102</td><td></td></tr> <tr><td>G</td><td>\$3,425</td><td></td></tr> <tr><td>H</td><td>\$3,769</td><td></td></tr> <tr><td>I</td><td>\$4,307</td><td></td></tr> <tr><td>J</td><td>\$4,951</td><td></td></tr> </tbody> </table>	COM	\$	Grade	COM	\$2,134		A	\$2,182		B	\$2,278		C	\$2,446		D	\$2,660		E	\$2,875		F	\$3,102		G	\$3,425		H	\$3,769		I	\$4,307		J	\$4,951	
		Dimensions	D	W	H																																										
Overall	32 ¾	87 ¾	17 ½																																												
COM	\$	Grade																																													
COM	\$2,134																																														
A	\$2,182																																														
B	\$2,278																																														
C	\$2,446																																														
D	\$2,660																																														
E	\$2,875																																														
F	\$3,102																																														
G	\$3,425																																														
H	\$3,769																																														
I	\$4,307																																														
J	\$4,951																																														
		<table border="1"> <thead> <tr> <th>Upholstery</th> <th colspan="2">Shipping</th> </tr> </thead> <tbody> <tr> <td>COM Ydg</td> <td>5 ½</td> <td>Ctn Wt 105</td> </tr> <tr> <td></td> <td></td> <td>Cu Ft 34</td> </tr> </tbody> </table>	Upholstery	Shipping		COM Ydg	5 ½	Ctn Wt 105			Cu Ft 34																																				
Upholstery	Shipping																																														
COM Ydg	5 ½	Ctn Wt 105																																													
		Cu Ft 34																																													

LOUNGE

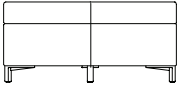
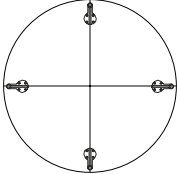
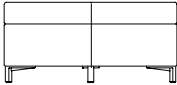
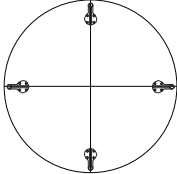
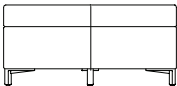
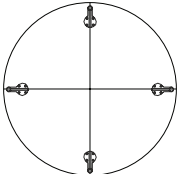
Description	① Model	Specifications	List Price Per Grade																																
Ottoman  	ZV6648 · upholstered seat · fabric application is railroaded Non-patterned fabrics are recommended	<table border="1"> <thead> <tr> <th>Dimensions</th> <th>D</th> <th>W</th> <th>H</th> </tr> </thead> <tbody> <tr> <td>Overall</td> <td>48</td> <td>48</td> <td>17½</td> </tr> </tbody> </table>	Dimensions	D	W	H	Overall	48	48	17½	<table border="1"> <thead> <tr> <th>COM</th> <th>Price</th> </tr> </thead> <tbody> <tr><td>COM</td><td>\$1,638</td></tr> <tr><td>A</td><td>\$1,674</td></tr> <tr><td>B</td><td>\$1,743</td></tr> <tr><td>C</td><td>\$1,865</td></tr> <tr><td>D</td><td>\$2,022</td></tr> <tr><td>E</td><td>\$2,178</td></tr> <tr><td>F</td><td>\$2,343</td></tr> <tr><td>G</td><td>\$2,577</td></tr> <tr><td>H</td><td>\$2,827</td></tr> <tr><td>I</td><td>\$3,219</td></tr> <tr><td>J</td><td>\$3,688</td></tr> </tbody> </table>	COM	Price	COM	\$1,638	A	\$1,674	B	\$1,743	C	\$1,865	D	\$2,022	E	\$2,178	F	\$2,343	G	\$2,577	H	\$2,827	I	\$3,219	J	\$3,688
		Dimensions	D	W	H																														
Overall	48	48	17½																																
COM	Price																																		
COM	\$1,638																																		
A	\$1,674																																		
B	\$1,743																																		
C	\$1,865																																		
D	\$2,022																																		
E	\$2,178																																		
F	\$2,343																																		
G	\$2,577																																		
H	\$2,827																																		
I	\$3,219																																		
J	\$3,688																																		
		<table border="1"> <thead> <tr> <th>Upholstery</th> <th>Shipping</th> </tr> </thead> <tbody> <tr> <td>COM Ydg</td> <td>4</td> </tr> <tr> <td></td> <td>Ctn Wt</td> </tr> <tr> <td></td> <td>95</td> </tr> <tr> <td></td> <td>Cu Ft</td> </tr> <tr> <td></td> <td>27</td> </tr> </tbody> </table>	Upholstery	Shipping	COM Ydg	4		Ctn Wt		95		Cu Ft		27																					
Upholstery	Shipping																																		
COM Ydg	4																																		
	Ctn Wt																																		
	95																																		
	Cu Ft																																		
	27																																		
Ottoman  	ZV6642 · upholstered seat · fabric application is railroaded Non-patterned fabrics are recommended	<table border="1"> <thead> <tr> <th>Dimensions</th> <th>D</th> <th>W</th> <th>H</th> </tr> </thead> <tbody> <tr> <td>Overall</td> <td>42</td> <td>42</td> <td>17½</td> </tr> </tbody> </table>	Dimensions	D	W	H	Overall	42	42	17½	<table border="1"> <thead> <tr> <th>COM</th> <th>Price</th> </tr> </thead> <tbody> <tr><td>COM</td><td>\$1,380</td></tr> <tr><td>A</td><td>\$1,416</td></tr> <tr><td>B</td><td>\$1,485</td></tr> <tr><td>C</td><td>\$1,607</td></tr> <tr><td>D</td><td>\$1,763</td></tr> <tr><td>E</td><td>\$1,920</td></tr> <tr><td>F</td><td>\$2,085</td></tr> <tr><td>G</td><td>\$2,319</td></tr> <tr><td>H</td><td>\$2,569</td></tr> <tr><td>I</td><td>\$2,960</td></tr> <tr><td>J</td><td>\$3,430</td></tr> </tbody> </table>	COM	Price	COM	\$1,380	A	\$1,416	B	\$1,485	C	\$1,607	D	\$1,763	E	\$1,920	F	\$2,085	G	\$2,319	H	\$2,569	I	\$2,960	J	\$3,430
		Dimensions	D	W	H																														
Overall	42	42	17½																																
COM	Price																																		
COM	\$1,380																																		
A	\$1,416																																		
B	\$1,485																																		
C	\$1,607																																		
D	\$1,763																																		
E	\$1,920																																		
F	\$2,085																																		
G	\$2,319																																		
H	\$2,569																																		
I	\$2,960																																		
J	\$3,430																																		
		<table border="1"> <thead> <tr> <th>Upholstery</th> <th>Shipping</th> </tr> </thead> <tbody> <tr> <td>COM Ydg</td> <td>4</td> </tr> <tr> <td></td> <td>Ctn Wt</td> </tr> <tr> <td></td> <td>79</td> </tr> <tr> <td></td> <td>Cu Ft</td> </tr> <tr> <td></td> <td>21</td> </tr> </tbody> </table>	Upholstery	Shipping	COM Ydg	4		Ctn Wt		79		Cu Ft		21																					
Upholstery	Shipping																																		
COM Ydg	4																																		
	Ctn Wt																																		
	79																																		
	Cu Ft																																		
	21																																		
Ottoman  	ZV6636 · upholstered seat · fabric application is railroaded Non-patterned fabrics are recommended	<table border="1"> <thead> <tr> <th>Dimensions</th> <th>D</th> <th>W</th> <th>H</th> </tr> </thead> <tbody> <tr> <td>Overall</td> <td>36</td> <td>36</td> <td>17½</td> </tr> </tbody> </table>	Dimensions	D	W	H	Overall	36	36	17½	<table border="1"> <thead> <tr> <th>COM</th> <th>Price</th> </tr> </thead> <tbody> <tr><td>COM</td><td>\$1,112</td></tr> <tr><td>A</td><td>\$1,144</td></tr> <tr><td>B</td><td>\$1,205</td></tr> <tr><td>C</td><td>\$1,311</td></tr> <tr><td>D</td><td>\$1,447</td></tr> <tr><td>E</td><td>\$1,584</td></tr> <tr><td>F</td><td>\$1,729</td></tr> <tr><td>G</td><td>\$1,934</td></tr> <tr><td>H</td><td>\$2,153</td></tr> <tr><td>I</td><td>\$2,495</td></tr> <tr><td>J</td><td>\$2,906</td></tr> </tbody> </table>	COM	Price	COM	\$1,112	A	\$1,144	B	\$1,205	C	\$1,311	D	\$1,447	E	\$1,584	F	\$1,729	G	\$1,934	H	\$2,153	I	\$2,495	J	\$2,906
		Dimensions	D	W	H																														
Overall	36	36	17½																																
COM	Price																																		
COM	\$1,112																																		
A	\$1,144																																		
B	\$1,205																																		
C	\$1,311																																		
D	\$1,447																																		
E	\$1,584																																		
F	\$1,729																																		
G	\$1,934																																		
H	\$2,153																																		
I	\$2,495																																		
J	\$2,906																																		
		<table border="1"> <thead> <tr> <th>Upholstery</th> <th>Shipping</th> </tr> </thead> <tbody> <tr> <td>COM Ydg</td> <td>3½</td> </tr> <tr> <td></td> <td>Ctn Wt</td> </tr> <tr> <td></td> <td>65</td> </tr> <tr> <td></td> <td>Cu Ft</td> </tr> <tr> <td></td> <td>16</td> </tr> </tbody> </table>	Upholstery	Shipping	COM Ydg	3½		Ctn Wt		65		Cu Ft		16																					
Upholstery	Shipping																																		
COM Ydg	3½																																		
	Ctn Wt																																		
	65																																		
	Cu Ft																																		
	16																																		

To Order, Specify:

- ① Model Number
- ② Fabric Selection - vendor, pattern and color

② See a selection of graded in fabric manufacturers and patterns on pages 12-20. Contact Customer Service for additional fabric options.

Specifications

- Fabric is railroaded.
- Non-patterned textile is recommended.
- Frame interior is upholstery grade plywood with glued solid hardwood cross members reinforced with wood screws.
- Seat has synthetic sheet webbing with cross strap and 3 5/8" thick high resiliency seat polyurethane multi-density foam.
- Back has 1 3/4" thick polyurethane foam, back lumbar has 10 channel stitch detail thru 3/8" thick polyurethane foam.
- 3/4" of high grade polyurethane foam covers a plywood constructed arm frame.
- Linking bracket included on modular units.▲

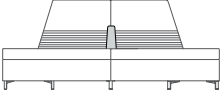
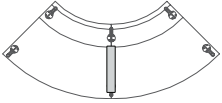
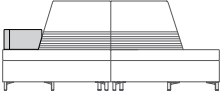
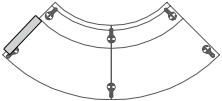
Description	D	W	H	CTN WT	CU FT	① Model	List Price	
Middle Arm				9	1		COM \$262	
 <ul style="list-style-type: none"> · use with custom configurations · indicate on order unit arm will be used on · tablet available, specify and add \$331 list for Glacier White or \$369 list for veneer · Note: fabric specified for the arm must be the same as the seat of the unit it will be used with. 							A \$269	
								B \$284
								C \$310
								D \$343
								E \$376
								F \$428
								G \$482
								H \$541
								I \$633
								J \$743
End Arm				9	1		COM \$262	
 <ul style="list-style-type: none"> · use with custom configurations · indicate on order unit arm will be used on · specify location, left or right as seated in unit · tablet available, specify and add \$331 list for Glacier White or \$369 list for veneer · power unit available, specify and add \$731 list; indicate right or left as seated and color Black (B) or White (W) · Note: fabric specified for the arm must be the same as the seat of the unit it will be used with. 							A \$269	
								B \$284
								C \$310
								D \$343
								E \$376
								F \$428
								G \$482
								H \$541
								I \$633
								J \$743

LOUNGE

To Order, Specify: ▲

① Fabric Selection - vendor, pattern and color

② See a selection of graded in fabric manufacturers and patterns on pages 12-20. Contact Customer Service for additional fabric options.

Specifications

- Fabric is railroaded.
- Non-patterned textile is recommended.
- Frame interior is upholstery grade plywood with glued solid hardwood cross members reinforced with wood screws.
- Seat has synthetic sheet webbing with cross strap and 3 5/8" thick high resiliency seat polyurethane multi-density foam.
- Back has 1 3/4" thick polyurethane foam, back lumbar has 10 channel stitch detail thru 3/8" thick polyurethane foam.
- 3/4" of high grade polyurethane foam covers a plywood constructed arm frame.

Description	D	W	H	CTN WT	CU FT	① Model	List Price
Coffee Table	24	48	18	51	15	OCFT6648-18	\$1,506

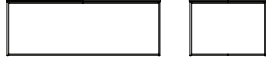

- Arctic Silver powder-coated frame
- Glacier White solid surface available, specify and add \$121 list

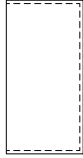

Coffee Table	30	30	18	42	12	OCFT6630-18	\$1,418
--------------	----	----	----	----	----	--------------------	---------

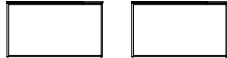

- Arctic Silver powder-coated frame
- Glacier White solid surface available, specify and add \$114 list

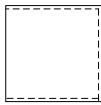

Half Round Coffee Table	24	48	18	45	15	ORCT6648-24-18	\$1,402
-------------------------	----	----	----	----	----	-----------------------	---------



- Arctic Silver powder-coated frame
- Glacier White solid surface available, specify and add \$113 list



Work Height Table	15	30	26	21	8	ORWT6630-26	\$1,226
-------------------	----	----	----	----	---	--------------------	---------



- Arctic Silver powder-coated frame
- Glacier White solid surface available, specify and add \$98 list



To Order, Specify:

- ① Model Number
- ② Top Material - Veneer or Glacier White Solid Surface
- ③ Wood Species - Cherry (CH1), Maple (MA1) or Walnut (WA1)
- ④ Wood Finish

⑤ Wood Finish Options:

Cherry - Flat Cut

AUT Autumn
BRL Barley
BBN Bourbon
BRG Brighton
CLA Classic
EAR Earthy
LGC Legacy
PRL Praline
SAF Saffron

Walnut - Flat Cut

AUB Auburn
ESP Espresso
MCH Mocha
NTO Night Owl
SIE Sienna
TOF Toffee
TRF Truffle

Maple - Flat Cut

ALE Ale
BUT Butterscotch
CIN Cinnamon
FLX Flax
VEN Venetian

Specifications

- Available in Cherry, Maple and Walnut veneer.

Description	D	W	H	CTN WT	CU FT	① Model	List Price
Work Height Table	12	24	26	17	6	ORET6624-12-26	\$869



- Arctic Silver powder-coated frame
- Glacier White solid surface available, specify and add \$71 list



Work Height Table	15	15	26	14	5	OST6615-26	\$927
-------------------	----	----	----	----	---	------------	-------

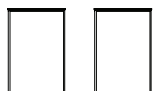

- Arctic Silver powder-coated frame
- Glacier White solid surface available, specify and add \$75 list



To Order, Specify:

- ① Model Number
- ② Top Material - Veneer or Glacier White Solid Surface
- ③ Wood Species - Cherry (CH1), Maple (MA1) or Walnut (WA1)
- ④ Wood Finish

③ Wood Finish Options:

Cherry - Flat Cut

- AUT Autumn
- BRL Barley
- BBN Bourbon
- BRG Brighton
- CLA Classic
- EAR Earthy
- LGC Legacy
- PRL Praline
- SAF Saffron

Walnut - Flat Cut

- AUB Auburn
- ESP Espresso
- MCH Mocha
- NTO Night Owl
- SIE Sienna
- TOF Toffee
- TRF Truffle

Maple - Flat Cut

- ALE Ale
- BUT Butterscotch
- CIN Cinnamon
- FLX Flax
- VEN Venetian

Specifications

- Available in Cherry, Maple and Walnut veneer.

Occasional Table Overview



Axis 422



Bentley 426

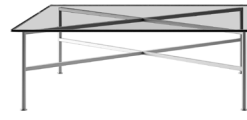

BeSPACE 430



Broadway 432



Brogan **NOW!** 438



Collective 440



Collective Motion 442



Connect 444



Encore **NOW!** 446



Finale **NOW!** 448



Finn 453



Finn Nu 456



Focus 459



Hedron **NOW!** 461



Laurel **NOW!** 463



Luci 465



Olympian **NOW!** 467



Shuffle 469



Solara 471



Traditional 473



Ziva 475

Axis Occasional Tables Order Check List:



Specify:

- 1. Model Number
- 2. Top Selection
 - A. Sketch Face Reverse Diamond Pattern
 - B. Glass Top
 - C. Glass Top with wood "X" Detail
 - D. Glass Top with Metal "X" Detail - Specify Metal Color Black Sandtex (BSX) or Stardust Silver (STS)
 - E. Corian Top - Specify Top Color: (L) Linen, (S) Sandstone, (M) Maui or (F) Flint
- 3. Wood Species - Maple (MA1)
- 4. Wood Finish
- 5. Edge Profile - Square (A) or Reeded (H)
- 6. Leg Option - Round (R) or Square (S)

Examples:

AX2424-22 (model #)	D (top selection)	MA1 (wood species)	AUB (finish)	H (edge)	R (leg)	BSX (metal "X" color)
AX2424-22 (model #)	E (top selection)	MA1 (wood species)	AUB (finish)	H (edge)	R (leg)	L (Corian® Top color)

1. Model Number

2. Top Selection:



Sketch face with reverse diamond pattern Maple veneer
Specify top option "A"



Glass top with 3/8" thick glass - 1/2" bevel edges ▲
Specify top option "B"



Glass top is 3/8" thick glass - 1/2" bevel edges
Decorative wood "X" detail visible through the clear glass top
Specify top option "C"



Glass top is 3/8" thick glass - 1/2" bevel edges
Decorative metal "X" detail with powder coat finish visible through the clear glass top
Specify top option "D" and metal color - Black Sandtex (BSX) or Stardust Silver (STS)



Corian® solid surface top is 1/2" thick - 1/2" bevel edges
Specify top option "E" and top color: (L) Linen, (S) Sandstone, (M) Maui or (F) Flint

3. Wood Species - Maple (MA1)

4. Wood Finish Options:

ALE Ale	FLX Flax
AUB Auburn	LGC Legacy
AUT Autumn	MCH Mocha
BRL Barley	NTO Night Owl
BBN Bourbon	PRL Praline
BRG Brighton	SAF Saffron
BUT Butterscotch	SIE Sienna
CIN Cinnamon	TOF Toffee
CLA Classic	TRF Truffle
EAR Earthy	VEN Venetian
ESP Espresso	

5. Edge Profile Options:

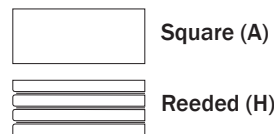

6. Leg Options:



Round leg - specify R



Square leg - specify S

Description	D	W	H	CTN WT	CU FT	① Model	List Price
End Table	30	30	22		5	AX3030-22	



Top Options:

(A) Veneer	44	\$879
(B) Glass	57	\$1,055
(C) Glass - wood X	60	\$1,127
(D) Glass - metal X	62	\$1,230
(E) Corian®	57	\$1,427

End Table	24	24	22		4	AX2424-22	
-----------	----	----	----	--	---	-----------	--



Top Options:

(A) Veneer	33	\$815
(B) Glass	38	\$903
(C) Glass - wood X	41	\$974
(D) Glass - metal X	43	\$1,043
(E) Corian®	38	\$1,185

End Table	20	28	22		4	AX2028-22	
-----------	----	----	----	--	---	-----------	--

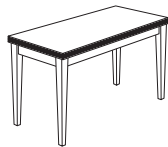

Top Options:

(A) Veneer	32	\$815
(B) Glass	37	\$903
(C) Glass - wood X	41	\$974
(D) Glass - metal X	43	\$1,043
(E) Corian®	37	\$1,185

To Order, Specify:
(See page 422 for details)

- ① Model Number
- ② Top Selection
 - A. Sketch Face Reverse Diamond Pattern
 - B. Glass Top
 - C. Glass Top with Wood "X" Detail
 - D. Glass Top with Metal "X" Detail - Specify Metal Color
Black Sandtex (BSX) or Stardust Silver (STS)
 - E. Corian Top - Specify Top Color: (L) Linen,
(S) Sandstone, (M) Maui or (F) Flint
- ③ Wood Species - Maple (MA1)
- ④ Wood Finish
- ⑤ Edge Profile - Square (A) or Reeded (H)
- ⑥ Leg Option - Round (R) or Square (S)

② Top Options:

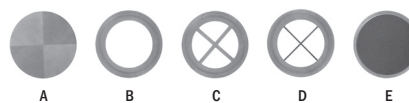

Optional Corian® top color:

- (L) Linen · (S) Sandstone
- (M) Maui · (F) Flint

④ Wood Finish Options:

- | | | | |
|-----|--------------|-----|-----------|
| ALE | Ale | FLX | Flax |
| AUB | Auburn | LGC | Legacy |
| AUT | Autumn | MCH | Mocha |
| BRL | Barley | NTO | Night Owl |
| BBN | Bourbon | PRL | Praline |
| BRG | Brighton | SAF | Saffron |
| BUT | Butterscotch | SIE | Sienna |
| CIN | Cinnamon | TOF | Toffee |
| CLA | Classic | TRF | Truffle |
| EAR | Earthy | VEN | Venetian |
| ESP | Espresso | | |

Specifications

- Wood species - Maple veneer.
- Optional veneer top features reverse diamond maple veneer.
- Optional glass top is 3/8" thick tempered with ▲ beveled edges.
- Optional Corian® top is 1/2" thick with beveled edges. (Not available with metal or wood "X").
- Tables ship KD.
- Standard with nylon glides.

Description	D	W	H	CTN WT	CU FT	① Model	List Price
End Table	29	N/A	22		5	AX29R-22	



Top Options:

(A) Veneer	29						\$1,279
(B) Glass	36						\$1,924
(C) Glass - wood X	38						\$1,993
(D) Glass - metal X	42						\$2,063
(E) Corian®	36						\$2,216

End Table	23	N/A	22		3	AX23R-22	
-----------	----	-----	----	--	---	----------	--



Top Options:

(A) Veneer	20						\$1,034
(B) Glass	30						\$1,409
(C) Glass - wood X	34						\$1,478
(D) Glass - metal X	37						\$1,550
(E) Corian®	30						\$1,689

Magazine Table	42	42	16		9	AX4242-16	
----------------	----	----	----	--	---	-----------	--

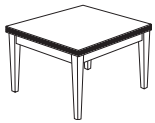

Top Options:

(A) Veneer	73						\$1,305
(B) Glass	101						\$1,329
(C) Glass - wood X	103						\$1,398
(D) Glass - metal X	112						\$1,448
(E) Corian®	101						\$2,250

Magazine Table	30	30	16		5	AX3030-16	
----------------	----	----	----	--	---	-----------	--

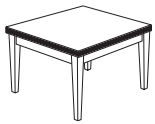

Top Options:

(A) Veneer	44						\$879
(B) Glass	57						\$1,055
(C) Glass - wood X	60						\$1,127
(D) Glass - metal X	62						\$1,230
(E) Corian®	57						\$1,427

Magazine Table	24	48	16		7	AX2448-16	
----------------	----	----	----	--	---	-----------	--



Top Options:

(A) Veneer	43						\$1,104
(B) Glass	58						\$1,150
(C) Glass - wood X	60						\$1,211
(D) Glass - metal X	66						\$1,330
(E) Corian®	58						\$1,482

Description	D	W	H	CTN WT	CU FT	① Model	List Price
Magazine Table	20	42	16		5	AX2042-16	



Top Options:

(A) Veneer	38	\$1,031
(B) Glass	54	\$1,099
(C) Glass - wood X	57	\$1,194
(D) Glass - metal X	63	\$1,274
(E) Corian®	54	\$1,446

Magazine Table	37	N/A	16		8	AX37R-16	
----------------	----	-----	----	--	---	----------	--



Top Options:

(A) Veneer	62	\$1,391
(B) Glass	69	\$2,066
(C) Glass - wood X	74	\$2,089
(D) Glass - metal X	78	\$2,132
(E) Corian®	69	\$2,306

Magazine Table	29	N/A	16		5	AX29R-16	
----------------	----	-----	----	--	---	----------	--



Top Options:

(A) Veneer	29	\$1,279
(B) Glass	35	\$1,924
(C) Glass - wood X	38	\$1,993
(D) Glass - metal X	42	\$2,063
(E) Corian®	36	\$2,216

Sofa Table	18	48	29		5	AX1848-29	
------------	----	----	----	--	---	-----------	--



Top Options:

(A) Veneer	42	\$1,131
(B) Glass	54	\$1,205
(C) Glass - wood X	58	\$1,281
(D) Glass - metal X	64	\$1,361
(E) Corian®	54	\$1,505

To Order, Specify:
(See page 422 for details)

- ① Model Number
- ② Top Selection
 - A. Sketch Face Reverse Diamond Pattern
 - B. Glass Top
 - C. Glass Top with Wood "X" Detail
 - D. Glass Top with Metal "X" Detail - Specify Metal Color
Black Sandtex (BSX) or Stardust Silver (STS)
 - E. Corian Top - Specify Top Color: (L) Linen,
(S) Sandstone, (M) Maui or (F) Flint
- ③ Wood Species - Maple (MA1)
- ④ Wood Finish
- ⑤ Edge Profile - Square (A) or Reeded (H)
- ⑥ Leg Option - Round (R) or Square (S)

② Top Options:

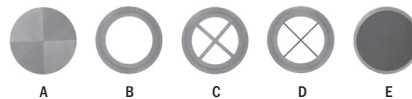

Optional Corian® top color:

- (L) Linen
- (S) Sandstone
- (M) Maui
- (F) Flint

④ Wood Finish Options:

- | | |
|------------------|---------------|
| ALE Ale | FLX Flax |
| AUB Auburn | LGC Legacy |
| AUT Autumn | MCH Mocha |
| BRL Barley | NTO Night Owl |
| BBN Bourbon | PRL Praline |
| BRG Brighton | SAF Saffron |
| BUT Butterscotch | SIE Sienna |
| CIN Cinnamon | TOF Toffee |
| CLA Classic | TRF Truffle |
| EAR Earthy | VEN Venetian |
| ESP Espresso | |

Specifications

- Wood species - Maple veneer.
- Optional veneer top features reverse diamond maple veneer.
- Optional glass top is 3/8" thick tempered with beveled edges.
- Optional Corian® top is 1/2" thick with beveled edges. (Not available with metal or wood "X").
- Tables ship KD.
- Standard with nylon glides.

Bentley Occasional Tables Order Check List:



Specify:

- 1. Model Number
- 2. Top Selection
 - A. Sketch Face Reverse Diamond Pattern
 - B. Glass Top
 - C. Glass Top with Wood "X" Detail
 - D. Glass Top with Metal "X" Detail - Specify Metal Color Black Sandtex (BSX) or Stardust Silver (STS)
 - E. Corian Top - Specify Top Color: (L) Linen, (S) Sandstone, (M) Maui or (F) Flint
- 3. Wood Species - Maple (MA1)
- 4. Wood Finish

Examples:

BN2424-22 (model #)	D (top selection)	MA1 (wood species)	AUB (finish)	Y (edge)	S (leg)	BSX (metal "X" color)
BN2424-22 (model #)	E (top selection)	MA1 (wood species)	AUB (finish)	Y (edge)	S (leg)	L (Corian® Top color)

1. Model Number

3. Wood Species - Maple (MA1)

2. Top Selection:

4. Wood Finish Options:



Sketch face with reverse diamond pattern Maple veneer
Specify top option "A"



Glass top with 3/8" thick glass - 1/2" bevel edges ▲
Specify top option "B"



Glass top is 3/8" thick glass - 1/2" bevel edges
Decorative wood "X" detail visible through the clear glass top
Specify top option "C"



Glass top is 3/8" thick glass - 1/2" bevel edges
Decorative metal "X" detail with powder coat finish visible through the clear glass top
Specify top option "D" and metal color - Black Sandtex (BSX) or Stardust Silver (STS)



Corian® solid surface top is 1/2" thick - 1/2" bevel edges
Specify top option "E" and top color: (L) Linen, (S) Sandstone, (M) Maui or (F) Flint

ALE	Ale	FLX	Flax
AUB	Auburn	LGC	Legacy
AUT	Autumn	MCH	Mocha
BRL	Barley	NTO	Night Owl
BBN	Bourbon	PRL	Praline
BRG	Brighton	SAF	Saffron
BUT	Butterscotch	SIE	Sienna
CIN	Cinnamon	TOF	Toffee
CLA	Classic	TRF	Truffle
EAR	Earthy	VEN	Venetian
ESP	Espresso		

Description	D	W	H	CTN WT	CU FT	① Model	List Price
End Table	30	30	22		5	BN3030-22	

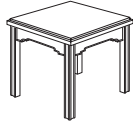

Top Options:

(A) Veneer	44	\$907
(B) Glass	57	\$1,089
(C) Glass - wood X	60	\$1,159
(D) Glass - metal X	62	\$1,249
(E) Corian®	57	\$1,466

End Table	24	24	22		4	BN2424-22	
-----------	----	----	----	--	---	-----------	--

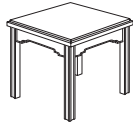

Top Options:

(A) Veneer	33 ▲	\$839
(B) Glass	38 ▲	\$931
(C) Glass - wood X	41 ▲	\$1,002
(D) Glass - metal X	43 ▲	\$1,074
(E) Corian®	38 ▲	\$1,221

End Table	20	28	22		4	BN2028-22	
-----------	----	----	----	--	---	-----------	--

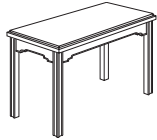

Top Options:

(A) Veneer	32	\$839
(B) Glass	37	\$931
(C) Glass - wood X	41	\$1,002
(D) Glass - metal X	43	\$1,074
(E) Corian®	37	\$1,221

To Order, Specify:

(See page 426 for details)

① Model Number

② Top Selection

- A. Sketch Face Reverse Diamond Pattern
- B. Glass Top
- C. Glass Top with Wood "X" Detail
- D. Glass Top with Metal "X" Detail - Specify Metal Color
Black Sandtex (BSX) or Stardust Silver (STS)
- E. Corian Top - Specify Top Color: (L) Linen,
(S) Sandstone, (M) Maui or (F) Flint

③ Wood Species - Maple (MA1)

④ Wood Finish

② Top Options:



Optional Corian® top color:

- (L) Linen · (S) Sandstone
- (M) Maui · (F) Flint

④ Wood Finish Options:

- | | | | |
|-----|--------------|-----|-----------|
| ALE | Ale | FLX | Flax |
| AUB | Auburn | LGC | Legacy |
| AUT | Autumn | MCH | Mocha |
| BRL | Barley | NTO | Night Owl |
| BBN | Bourbon | PRL | Praline |
| BRG | Brighton | SAF | Saffron |
| BUT | Butterscotch | SIE | Sienna |
| CIN | Cinnamon | TOF | Toffee |
| CLA | Classic | TRF | Truffle |
| EAR | Earthy | VEN | Venetian |
| ESP | Espresso | | |

Specifications

- Wood species - Maple veneer.
- Optional veneer top features reverse diamond maple veneer.
- Optional glass top is 3/8" thick tempered with ▲ beveled edges.
- Optional Corian® top is 1/2" thick with beveled edges. (Not available with metal or wood "X").
- Tables ship KD.
- Standard with nylon glides.

Description	D	W	H	CTN WT	CU FT	① Model	List Price
End Table	29	N/A	22		5	BN29R-22	



Top Options:

(A) Veneer				29			\$1,298
(B) Glass				36			\$1,990
(C) Glass - wood X				38			\$2,063
(D) Glass - metal X				42			\$2,131
(E) Corian®				36			\$2,280

End Table	23	N/A	22		3	BN23R-22	
-----------	----	-----	----	--	---	----------	--



Top Options:

(A) Veneer				20			\$1,039
(B) Glass				30			\$1,460
(C) Glass - wood X				34			\$1,533
(D) Glass - metal X				37			\$1,604
(E) Corian®				30			\$1,753

Magazine Table	42	42	16		9	BN4242-16	
----------------	----	----	----	--	---	-----------	--

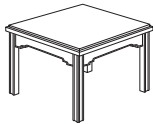

Top Options:

(A) Veneer				73			\$1,314
(B) Glass				101			\$1,369
(C) Glass - wood X				103			\$1,442
(D) Glass - metal X				112			\$1,498
(E) Corian®				101			\$2,318

Magazine Table	30	30	16		5	BN3030-16	
----------------	----	----	----	--	---	-----------	--

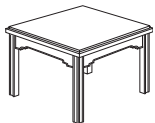

Top Options:

(A) Veneer				44			\$907
(B) Glass				57			\$1,089
(C) Glass - wood X				60			\$1,159
(D) Glass - metal X				62			\$1,249
(E) Corian®				57			\$1,466

Magazine Table	24	48	16		7	BN2448-16	
----------------	----	----	----	--	---	-----------	--

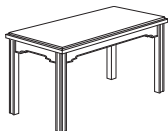

Top Options:

(A) Veneer				43			\$1,120
(B) Glass				58			\$1,184
(C) Glass - wood X				60			\$1,248
(D) Glass - metal X				66			\$1,377
(E) Corian®				58			\$1,527

Description	D	W	H	CTN WT	CU FT	① Model	List Price
Magazine Table	20	42	16		5	BN2042-16	

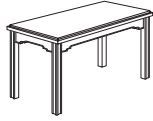

Top Options:

(A) Veneer	38	\$1,053
(B) Glass	54	\$1,131
(C) Glass - wood X	57	\$1,231
(D) Glass - metal X	63	\$1,313
(E) Corian®	54	\$1,489

Magazine Table	37	N/A	16		8	BN37R-16	
----------------	----	-----	----	--	---	----------	--



Top Options:

(A) Veneer	62	\$1,423
(B) Glass	69	\$2,126
(C) Glass - wood X	74	\$2,154
(D) Glass - metal X	78	\$2,197
(E) Corian®	69	\$2,375

Magazine Table	29	N/A	16		5	BN29R-16	
----------------	----	-----	----	--	---	----------	--



Top Options:

(A) Veneer	29	\$1,298
(B) Glass	35	\$1,990
(C) Glass - wood X	38	\$2,063
(D) Glass - metal X	42	\$2,131
(E) Corian®	36	\$2,280

Sofa Table	18	48	29		5	BN1848-29	
------------	----	----	----	--	---	-----------	--

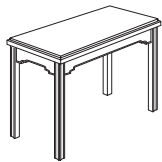

Top Options:

(A) Veneer	42	\$1,147
(B) Glass	54	\$1,242
(C) Glass - wood X	58	\$1,328
(D) Glass - metal X	64	\$1,402
(E) Corian®	54	\$1,549

To Order, Specify:
(See page 426 for details)

- ① Model Number
- ② Top Selection
 - A. Sketch Face Reverse Diamond Pattern
 - B. Glass Top
 - C. Glass Top with Wood "X" Detail
 - D. Glass Top with Metal "X" Detail - Specify Metal Color
Black Sandtex (BSX) or Stardust Silver (STS)
 - E. Corian Top - Specify Top Color: (L) Linen,
(S) Sandstone, (M) Maui or (F) Flint
- ③ Wood Species - Maple (MA1)
- ④ Wood Finish

② Top Options:

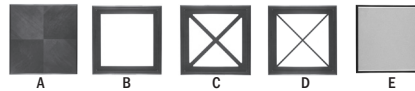

Optional Corian® top color:

- (L) Linen
- (S) Sandstone
- (M) Maui
- (F) Flint

④ Wood Finish Options:

- | | |
|------------------|---------------|
| ALE Ale | FLX Flax |
| AUB Auburn | LGC Legacy |
| AUT Autumn | MCH Mocha |
| BRL Barley | NTO Night Owl |
| BBN Bourbon | PRL Praline |
| BRG Brighton | SAF Saffron |
| BUT Butterscotch | SIE Sienna |
| CIN Cinnamon | TOF Toffee |
| CLA Classic | TRF Truffle |
| EAR Earthy | VEN Venetian |
| ESP Espresso | |

Specifications

- Wood species - Maple veneer.
- Optional veneer top features reverse diamond maple veneer.
- Optional glass top is 3/8" thick tempered with beveled edges.
- Optional Corian® top is 1/2" thick with beveled edges. (Not available with metal or wood "X").
- Tables ship KD.
- Standard with nylon glides.

BeSpace Occasional Tables Order Check List:



Specify:

- 1. Model Number
- 2. Wood Species - Rift Cut White Oak (WK4) or Flat Cut Walnut (WA1)
- 3. Wood Finish
- 4. Glass Color - Clear (GTC01) or Smoke (GTC04)
- 6. Metal Leg Color - Matte Black (MBK), Soft Nickel (SNK) or Stardust Silver (STS)

Example:

BS2020WTT | **WK4** | **CLK** | **MBK**
 (model #) | (wood species) | (finish) | (metal leg color)

1. Model Number





2. Wood Species - Rift Cut White Oak (WK4) or Flat Cut Walnut (WA1)

3. Wood Finish Options:

- CLK Clear on Rift Cut White Oak
- CLW Clear on Flat Cut Walnut

4. Glass Color - Clear (GTC01) or Smoke (GTC04)

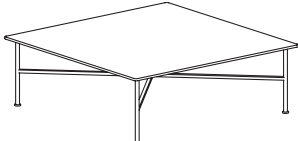
5. Metal Leg Color - Matte Black (MBK), Soft Nickel (SNK) or Stardust Silver (STS)

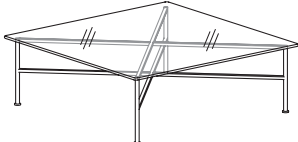
Description	D	W	H	CTN WT	CU FT	① Model	List Price
Side Wood Table  <ul style="list-style-type: none"> • 5/8" thick plywood top • metal frame 	20	20	16 1/4	25	5	BS2020WTT	\$2,515
Rectangular Wood Coffee Table  <ul style="list-style-type: none"> • 5/8" thick plywood top • metal frame 	24	48	16 1/4	35	14	BS2448WTT	\$2,646
Square Wood Coffee Table  <ul style="list-style-type: none"> • 5/8" thick plywood top • metal frame 	48	48	16 1/4	55	26	BS4848WTT	\$2,762
Glass Side Table  <ul style="list-style-type: none"> • 1/2" thick tempered glass top • metal frame 	20	20	16 1/4	30	5	BS2020GTT	\$2,549
Rectangular Glass Coffee Table  <ul style="list-style-type: none"> • 1/2" thick tempered glass top • metal frame 	24	48	16 1/4	40	14	BS2448GTT	\$2,733
Square Glass Coffee Table  <ul style="list-style-type: none"> • 1/2" thick tempered glass top • metal frame 	48	48	16 1/4	60	26	BS4848GTT	\$2,963

To Order, Specify:

- ① Model Number
- ② Wood Species - Rift Cut White Oak (WK4) or Flat Cut Walnut (WA1)
- ③ Wood Finish
- ④ Glass Color - Clear (GTC01) or Smoke (GTC04)
- ⑤ Metal Leg Color - Matte Black (MBK), Soft Nickel (SNK) or Stardust Silver (STS)

③ Wood Finish Options:

- CLK Clear on Rift Cut White Oak
- CLW Clear on Flat Cut Walnut

Specifications

- Wood species - Rift Cut White Oak or Flat Cut Walnut.
- Exterior feet and leg frames are fabricated from 14 gauge steel tubing and 14 gauge flat stock.

Broadway Occasional Tables Order Check List:



Specify:

- 1. Model Number
- 2. Finish Application
 - A. All Same Finish
 - B. Two Tone
- 3. Wood Species - Cherry (CH1), Maple (MA1) or Walnut (WA1)
 - A. Top
 - B. Legs
- 4. Finish Color:
 - A. Top
 - B. Legs
- 5. Metal Color
- 6. Edge Profile
- 7. Product Options

Example:

BR1860ST | **ALL SAME FINISH** | **CH1** | **PRL** | **L**
 (model #) | (finish application) | (wood species) | (finish) | (edge)

1. Model Number

2. Finish Application

- A. All Same Finish
 - B. Two Tone
- Two Tone Finish**

Models with a 1 1/2" horizontal worksurface can be produced with two different color finishes or two tone (Color Finish and standard wood stain). If the whole unit is produced in a singular paint finish or a singular wood stain there will be no upcharge. Units produced in a two tone finish (either two paint finishes or a paint finish and a wood stain) will require an 8% upcharge.

3. Wood Species - Cherry (CH1), Maple (MA1) or Walnut (WA1)

4. A. Wood Finish Options:

Cherry		Maple		Walnut	
AUT	Autumn*	ALE	Ale*	AUB	Auburn*
BRL	Barley*	BUT	Butterscotch	ESP	Espresso
BBN	Bourbon*	CIN	Cinnamon*	MCH	Mocha*
BRG	Brighton*	FLX	Flax	NTO	Night Owl*
CLA	Classic*	VEN	Venetian*	SIE	Sienna*
EAR	Earthy			TOF	Toffee*
LGC	Legacy*			TRF	Truffle*
PRL	Praline*				
SAF	Saffron*				

Color Finish Options (Maple Veneer Only):

BKD	Backdrop	GRV	Greek Villa
BFX	Black Fox	NET	Network Gray
BWH	Bright White	NWH	Nonchalant White
CGP	Cargo Pants	STM	Storm
CHT	Chatroom	TRC	Tricorn Black
FRR	French Roast		

5. Metal Color - Black Sandtex (BSX), Soft Nickel (SNK) or Stardust Silver (STS)

6. Wood Edge Profile Options:

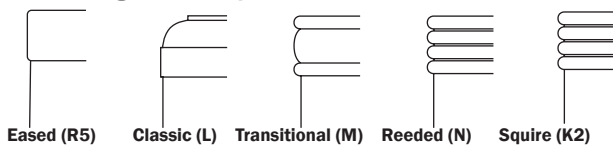

7. Product Options:

- Sheen Modification: 15% upcharge (For Top ONLY)
- Change Veneer Species: 40% upcharge (For oak only)

Optional Coordinating Wood Grain Laminate Table Top - no upcharge. Finishes with an asterisk have a coordinating laminate available.

NOTE: Any specials or modifications must be accompanied by quote and approved drawing.

See additional Broadway product in our JSI Casegoods and JSI Conference Price Lists.

Description	D	W	H	CTN WT	CU FT	① Model	List Price
Sofa Table	18	60	30	81	4	BR1860ST	\$929

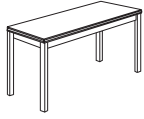

· ships KD in one carton

Magazine Table	20	42	16	63	4	BR2042MT	\$779
----------------	----	----	----	----	---	----------	-------



· ships KD in one carton

End Table	24	24	20	43	3	BR2424ET	\$654
-----------	----	----	----	----	---	----------	-------

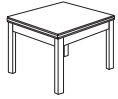

· ships KD in one carton

End Table	20	28	20	43	3	BR2028ET	\$647
-----------	----	----	----	----	---	----------	-------

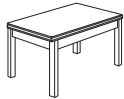

· ships KD in one carton

To Order, Specify: ▲

- ① Model Number
- ② Finish Application
 - A. All Same Finish
 - B. Two Tone
- ③ Wood Species - Cherry (CH1), Maple (MA1) or Walnut (WA1)
- ④ Finish Color
 - A. Top
 - B. Legs
- ⑤ Edge Profile
- ⑥ Product Options

④ Wood Finish Options:

Cherry	Maple	Walnut
AUT Autumn*	ALE Ale*	AUB Auburn*
BRL Barley*	BUT Butterscotch	ESP Espresso
BBN Bourbon*	CIN Cinnamon*	MCH Mocha*
BRG Brighton*	FLX Flax	NTO Night Owl*
CLA Classic*	VEN Venetian*	SIE Sienna*
EAR Earthy		TOF Toffee*
LGC Legacy*		TRF Truffle*
PRL Praline*		
SAF Saffron*		

Color Finish Options (Maple Veneer Only):

BKD Backdrop	GRV Greek Villa
BFX Black Fox	NET Network Gray
BWH Bright White	NWH Nonchalant White
CGP Cargo Pants	STM Storm
CHT Chatroom	TRC Tricorn Black
FRR French Roast	

⑥ Wood Edge Profile Options:



Specifications

- Wood species - Cherry, Maple or Walnut.
- Five edge details available.
- Top features a multi-step, semi-open pore finish with a satin finish.
- Tables ship KD.

Description	D	W	H	CTN WT	CU FT	① Model	List Price
Metal Frame End Table	24	24	20	51	10	BR2424G-20	\$1,852

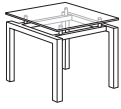

- with glass top
- metal 1 1/2" square tube frame - specify metal color option; Black Sandtex, Soft Nickel or Stardust Silver
- clear glass top crated for shipment
- field assembly of glass top to metal base frame

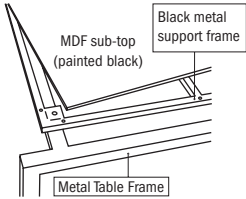

Metal Frame End Table	24	24	20	51	10	BR2424V-20	\$1,834
------------------------------	----	----	----	----	----	-------------------	----------------

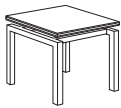

- with veneer top
- metal 1 1/2" square tube frame - specify metal color option; Black Sandtex, Soft Nickel or Stardust Silver
- black support for veneer top
- field assembly of veneer top to metal base frame
- wood species, finish and edge profile must be specified

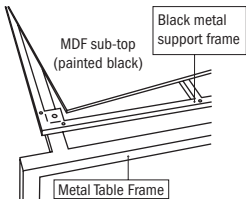

Metal Frame End Table	24	24	20	51	10	BR2424X-20	\$1,815
------------------------------	----	----	----	----	----	-------------------	----------------

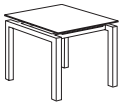

- for COM top
- includes: end table frame, black metal support and black sub top
- CUSTOMER MUST SUPPLY WORK SURFACE AND INSTALLATION AT FINAL DESTINATION
- metal 1 1/2" square tube frame - specify metal color option; Black Sandtex, Soft Nickel or Stardust Silver
- black support for COM top
- field assembly of COM top support to metal base frame

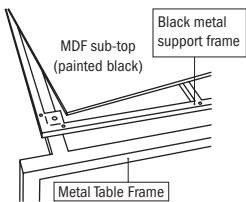

Metal Frame Magazine Table	36	36	17	80	18	BR3636G-17	\$2,293
-----------------------------------	----	----	----	----	----	-------------------	----------------

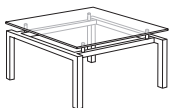

- with glass top
- metal 1 1/2" square tube frame - specify metal color option; Black Sandtex, Soft Nickel or Stardust Silver
- clear glass top crated for shipment
- field assembly of glass top to metal base frame

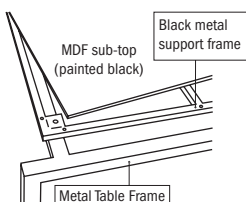

Description	D	W	H	CTN WT	CU FT	① Model	List Price
Metal Frame Magazine Table	36	36	17	80	18	BR3636V-17	\$2,272



- with veneer top
- metal 1 1/2" square tube frame - specify metal color option; Black Sandtex, Soft Nickel or Stardust Silver
- black support for veneer top
- ships fully assembled
- wood species, finish and edge profile must be specified

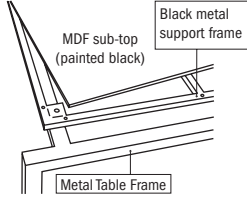

Metal Frame Magazine Table	36	36	17	80	18	BR3636X-17	\$2,249
-----------------------------------	----	----	----	----	----	-------------------	----------------

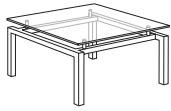

- for COM top
- includes: end table frame, black metal support and black sub top
- CUSTOMER MUST SUPPLY WORK SURFACE AND INSTALLATION AT FINAL DESTINATION
- metal 1 1/2" square tube frame - specify metal color option; Black Sandtex, Soft Nickel or Stardust Silver
- black support for COM top
- field assembly of COM top support to metal base frame

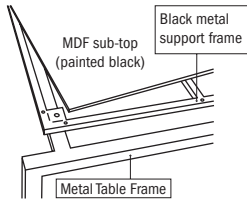

To Order, Specify: ▲

- ① Model Number
- ② Wood Species - Cherry (CH1), Maple (MA1) or Walnut (WA1)
- ③ Metal Color - Black Sandtex (BSX), Soft Nickel (SNK) or Stardust Silver (STS)
- ④ Edge Profile
- ⑤ Product Options

④ Wood Finish Options:

Cherry	Maple	Walnut
AUT Autumn*	ALE Ale*	AUB Auburn*
BRL Barley*	BUT Butterscotch	ESP Espresso
BBN Bourbon*	CIN Cinnamon*	MCH Mocha*
BRG Brighton*	FLX Flax	NTO Night Owl*
CLA Classic*	VEN Venetian*	SIE Sienna*
EAR Earthy		TOF Toffee*
LGC Legacy*		TRF Truffle*
SAF Saffron*		
PRL Praline*		

Color Finish Options (Maple Veneer Only):

BKD Backdrop	GRV Greek Villa
BFX Black Fox	NET Network Gray
BWH Bright White	NWH Nonchalant White
CGP Cargo Pants	STM Storm
CHT Chatroom	TRC Tricorn Black
FRR French Roast	

⑥ Wood Edge Profile Options:



Specifications

- Wood species - Cherry, Maple or Walnut.
- Five edge details available.
- Top features a multi-step, semi-open pore finish with a satin finish.
- Tables ship KD.

Description	D	W	H	CTN WT	CU FT	① Model	List Price
Metal Frame Magazine Table	24	48	17	81	16	BR2448G-17	\$2,167

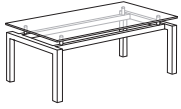

- with glass top
- metal 1 1/2" square tube frame - specify metal color option; Black Sandtex, Soft Nickel or Stardust Silver
- clear glass top crated for shipment
- field assembly of glass top to metal base frame

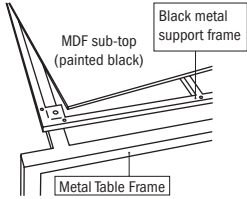

Metal Frame Magazine Table	24	48	17	81	16	BR2448V-17	\$2,145
-----------------------------------	----	----	----	----	----	-------------------	----------------

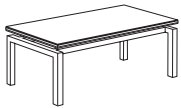

- with veneer top
- metal 1 1/2" square tube frame - specify metal color option; Black Sandtex, Soft Nickel or Stardust Silver
- black support for veneer top
- ships fully assembled
- wood species, finish and edge profile must be specified

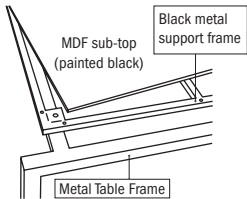

Metal Frame Magazine Table	24	48	17	81	16	BR2448X-17	\$2,124
-----------------------------------	----	----	----	----	----	-------------------	----------------

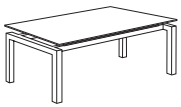

- for COM top
- includes: end table frame, black metal support and black sub top
- CUSTOMER MUST SUPPLY WORK SURFACE AND INSTALLATION AT FINAL DESTINATION
- metal 1 1/2" square tube frame - specify metal color option; Black Sandtex, Soft Nickel or Stardust Silver
- black support for COM top
- field assembly of COM top support to metal base frame

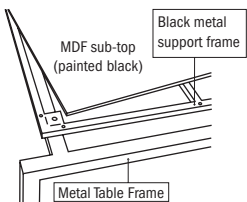

Description	D	W	H	CTN WT	CU FT	① Model	List Price
Round Magazine Table	42	42	16			BR42MTD	\$2,391



Consists of:

BR42TT	Table Top	67	5			\$1,333
BR18-16RB	Round Base	79	5			\$1,058

· ships KD in two cartons

Round Magazine Table	36	36	16			BR36MTD	\$2,231
----------------------	----	----	----	--	--	---------	---------



Consists of:

BR36TT	Table Top	50	4			\$1,173
BR18-16RB	Round Base	79	5			\$1,058

· ships KD in two cartons

To Order, Specify:

- ① Model Number
- ② Finish Application
 - A. All Same Finish
 - B. Two Tone
- ③ Wood Species - Cherry (CH1), Maple (MA1) or Walnut (WA1)
- ④ Finish Color
 - A. Top
 - B. Legs
- ⑤ Metal Color - Black Sandtex (BSX), Soft Nickel (SNK) or Stardust Silver (STS)
- ⑥ Edge Profile
- ⑦ Product Options

④ Wood Finish Options:

Cherry	Maple	Walnut
AUT Autumn*	ALE Ale*	AUB Auburn*
BRL Barley*	BUT Butterscotch	ESP Espresso
BBN Bourbon*	CIN Cinnamon*	MCH Mocha*
BRG Brighton*	FLX Flax	NTO Night Owl*
CLA Classic*	VEN Venetian*	SIE Sienna*
EAR Earthy		TOF Toffee*
LGC Legacy*		TRF Truffle*
SAF Saffron*		
PRL Praline*		

Color Finish Options (Maple Veneer Only):

BKD Backdrop	GRV Greek Villa
BFX Black Fox	NET Network Gray
BWH Bright White	NWH Nonchalant White
CGP Cargo Pants	STM Storm
CHT Chatroom	TRC Tricorn Black
FRR French Roast	

⑥ Wood Edge Profile Options:



Specifications

- Wood species - Cherry, Maple or Walnut.
- Five edge details available.
- Top features a multi-step, semi-open pore finish with a satin finish.
- Tables ship KD.

Brogan Occasional Tables Order Check List:



Specify:

- 1. Model Number
- 2. Wood Species - Cherry (CH1) or Walnut (WA1)
- 3. Wood Finish
- 4. Product Options

Example:

BG1860ST | **WA1** | **NTO**
(model #) | (wood species) | (finish)

1. Model Number

2. Wood Species - Cherry (CH1) or Walnut (WA1)

3. Wood Finish Options:

Cherry

- AUT Autumn*
- BRL Barley*
- BBN Bourbon*
- BRG Brighton*
- CLA Classic*
- EAR Earthy
- LGC Legacy*
- PRL Praline*
- SAF Saffron*

Walnut

- AUB Auburn*
- ESP Espresso
- MCH Mocha*
- NTO Night Owl*
- SIE Sienna*
- TOF Toffee*
- TRF Truffle*

4. Product Options:

- High Pressure Laminate Top: No additional upcharge (For standard matching wood grain laminates only)
- Sheen Modification: 15% upcharge (For Top ONLY)
- Change Veneer Species: 40% upcharge (For oak only)[▲]

Optional Coordinating Wood Grain Laminate Table Top - no upcharge. Finishes with an asterisk have a coordinating laminate available.

NOTE: Any specials or modifications must be accompanied by quote and approved drawing.

See additional Brogan product in our JSI Casegoods and JSI Conference Price Lists.

Edge Profile:

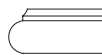

Cherry veneer species is available on the  quickship program.[▲]

Description	D	W	H	CTN WT	CU FT	① Model	List Price
Sofa Table	18	60	30	81	4	BG1860ST	\$939

NOW!

· ships KD in one carton

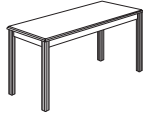

Magazine Table	20	42	16	63	4	BG2042MT	\$791
----------------	----	----	----	----	---	----------	-------

NOW!

· ships KD in one carton



End Table	24	24	20	43	3	BG2424ET	\$669
-----------	----	----	----	----	---	----------	-------

NOW!

· ships KD in one carton

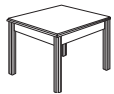

End Table	20	28	20	43	3	BG2028ET	\$666
-----------	----	----	----	----	---	----------	-------

NOW!

· ships KD in one carton



To Order, Specify:

- ① Model Number
- ② Wood Species - Cherry (CH1) or Walnut (WA1)
- ③ Wood Finish
- ④ Product Options

③ Wood Finish Options:

Cherry

AUT Autumn*
BRL Barley*
BBN Bourbon*
BRG Brighton*
CLA Classic*
EAR Earthy
LGC Legacy*
PRL Praline*
SAF Saffron*

Walnut ▲

AUB Auburn*
ESP Espresso
MCH Mocha*
NTO Night Owl*
SIE Sienna*
TOF Toffee*
TRF Truffle*

Specifications

- Wood species - Cherry or Walnut.
- Tops feature a multi-step, semi-open pore finish that is hand rubbed to a satin finish.
- Tables ship KD.

Edge Profile:



When ordering Quickship products, place a "Q" in front of model number.
Example: QVV3072DD

NOW!
Need it.
JSI Quickship

Collective Lounge Occasional Tables Order Check List:

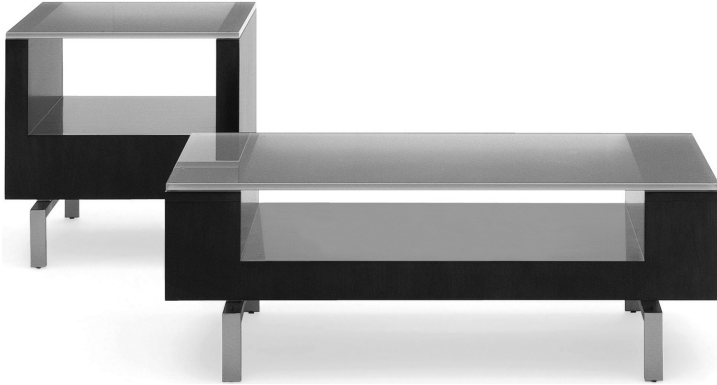

Specify:

- 1. Model Number
- 2. Wood Species - Maple (M)
- 3. Wood Finish

Example:

OCST4560-29 | M | AUB
 (model #) | (wood species) | (finish)

1. Model Number

2. Wood Species - Maple (M)

3. Wood Finish Options:

ALE	Ale	FLX	Flax
AUB	Auburn	LGC	Legacy
AUT	Autumn	MCH	Mocha
BRL	Barley	NTO	Night Owl
BBN	Bourbon	PRL	Praline
BRG	Brighton	SAF	Saffron
BUT	Butterscotch	SIE	Sienna
CIN	Cinnamon	TOF	Toffee
CLA	Classic	TRF	Truffle
EAR	Earthy	VEN	Venetian
ESP	Espresso		

Description	D	W	H	CTN WT	CU FT	① Model	List Price
Console Table	15	60	29	117	19	OCST4560-29	\$4,658

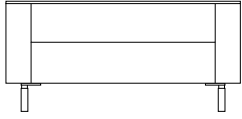

Coffee Table	24	48	17	181	15	OCFT4548-17	\$4,265
--------------	----	----	----	-----	----	-------------	---------

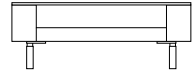

End Table	30	24	24	156	13	OET4524-24	\$3,563
-----------	----	----	----	-----	----	------------	---------

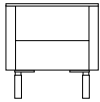

Coffee Table	36	36	17	162	16	OCFT4536-17	\$4,218
	30	30	17	151	12	OCFT4530-17	\$4,101



End Table	24	24	24	128	11	OST4524-24	\$3,456
	18	18	24	86	7	OST4518-24	\$2,987

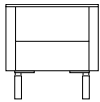

To Order, Specify:

- ① Model Number
- ② Wood Species - Maple (M)
- ③ Wood Finish

③ Wood Finish Options:

ALE	Ale	FLX	Flax
AUB	Auburn	LGC	Legacy
AUT	Autumn	MCH	Mocha
BRL	Barley	NTO	Night Owl
BBN	Bourbon	PRL	Praline
BRG	Brighton	SAF	Saffron
BUT	Butterscotch	SIE	Sienna
CIN	Cinnamon	TOF	Toffee
CLA	Classic	TRF	Truffle
EAR	Earthy	VEN	Venetian
ESP	Espresso		

Specifications

- Exposed wood surfaces are Maple veneer.
- ½" thick tempered frosted glass with screen print on underside and fingerprint resistant coating.
- Steel structured base has an Arctic Silver powder coat finish.
- Hardwood frame glued with double dowels and reinforced with wood screws.

Collective Motion Occasional Tables Order Check List:**Specify:**

- 1. Model Number
- 2. Wood Species - Maple (M)
- 3. Wood Finish

Example:

OCST4548M-30 | **MA1** | **AUB**
 (model #) | (wood species) | (finish)

1. Model Number**2. Wood Species - Maple (MA1)****3. Wood Finish Options:**

ALE	Ale	FLX	Flax
AUB	Auburn	LGC	Legacy
AUT	Autumn	MCH	Mocha
BRL	Barley	NTO	Night Owl
BBN	Bourbon	PRL	Praline
BRG	Brighton	SAF	Saffron
BUT	Butterscotch	SIE	Sienna
CIN	Cinnamon	TOF	Toffee
CLA	Classic	TRF	Truffle
EAR	Earthy	VEN	Venetian
ESP	Espresso		

Description	D	W	H	CTN WT	CU FT	① Model	List Price
Console Table	18	48	29 ½	118	18	OCST4548M-30	\$2,282

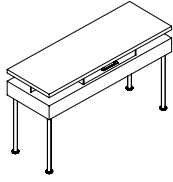

- Maple veneer
- Anodized Aluminum drawer pulls
- casters not available

Coffee Table	42	42	17 ¾	229	21	OCFT4542M-18	\$2,632
	30	30	16 ¾	219	10	OCFT4530M-16	\$1,529

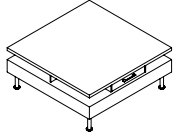

- Maple veneer
- Anodized Aluminum drawer pulls
- power/communication module available, specify and add \$521 list

End Table	20	20	24	207	7	OST4520M-24	\$2,102
-----------	----	----	----	-----	---	-------------	---------

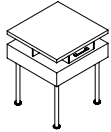

- Maple veneer
- Anodized Aluminum drawer pulls

Coffee Table	36 ¾	36 ¾	16 ¾	103	15	ORT4536M-17	\$3,353
--------------	------	------	------	-----	----	-------------	---------

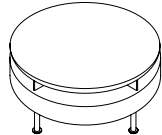

- Maple veneer
- Skirt not available in paint ▲

End Table	20	20	24 ¾	43	7	ORT4520M-24	\$2,907
-----------	----	----	------	----	---	-------------	---------

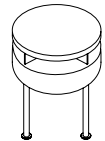

- Maple veneer
- Skirt not available in paint ▲

To Order, Specify:

- ① Model Number
- ② Wood Species - Maple (MA1)
- ③ Wood Finish
- ④ Skirt Color ▲
 - A. Same as Top
 - B. Paint

③ Wood Finish Options:

ALE Ale	FLX Flax
AUB Auburn	LGC Legacy
AUT Autumn	MCH Mocha
BRL Barley	NTO Night Owl
BBN Bourbon	PRL Praline
BRG Brighton	SAF Saffron
BUT Butterscotch	SIE Sienna
CIN Cinnamon	TOF Toffee
CLA Classic	TRF Truffle
EAR Earthy	VEN Venetian
ESP Espresso	

④ Paint Color Options:

BKD Backdrop	GRV Greek Villa
BFX Black Fox	NET Network Gray
BWH Bright White	NWH Nonchalant White
CGP Cargo Pants	STM Storm
CHT Chatroom	TRC Tricorn Black
FRR French Roast	

Specifications

- Maple veneer exposed wood surfaces.
- Legs feature slider glides for easy mobility.
- Arctic Silver tubular steel legs.

Connect Occasional Tables Order Check List:



Specify:

- 1. Model Number
- 2. Wood Species - Cherry (CH1), Maple (MA1) or Walnut (WA1)
- 3. Wood Finish
- 4. Metal Color - Black Sandtex (BSX), Soft Nickel (SNK) or Stardust Silver (STS)

Examples:

CT4848-15 | CH1 | AUT | BSX
 (model #) | (wood species) | (finish) | (metal finish)

1. Model Number

2. Wood Species - Cherry (CH1), Maple (MA1) or Walnut (WA1)

3. Wood Finish Options:

Cherry

AUT Autumn
 BRL Barley
 BRG Brighton
 BBN Bourbon
 CLA Classic
 EAR Earthy
 LGC Legacy
 PRL Praline
 SAF Saffron

Maple

ALE Ale
 BUT Butterscotch
 CIN Cinnamon
 FLX Flax
 VEN Venetian

Walnut

AUB Auburn
 ESP Espresso
 MCH Mocha
 NTO Night Owl
 TOF Toffee
 TRF Truffle
 SIE Sienna

4. Metal Finish - Black Sandtex (BSX), Soft Nickel (SNK) or Stardust Silver (STS)

Description	D	W	H	CTN WT	CU FT	① Model	List Price
Magazine Table	48	48	15	202	30	CT4848-15	\$2,518

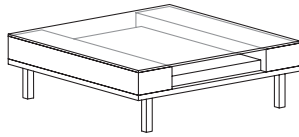

- glass top
- freestanding application

Magazine Table	42	42	15	173	21	CT4242-15	\$2,347
----------------	----	----	----	-----	----	-----------	---------

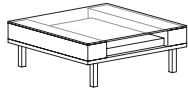

- glass top
- freestanding application

Magazine Table	36	36	15	145	16	CT3636-15	\$2,219
----------------	----	----	----	-----	----	-----------	---------

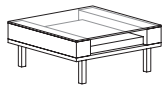

- glass top
- freestanding application

Magazine Table	24	48	15	137	15	CT2448-15	\$2,193
----------------	----	----	----	-----	----	-----------	---------

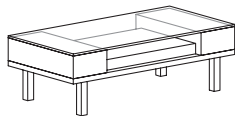

- glass top
- freestanding application

End Table	32	32	22	134	18	CT3232-22	\$2,103
-----------	----	----	----	-----	----	-----------	---------

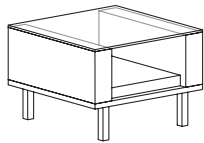

- glass top
- freestanding application

Sofa Table	18	60	28	182	25	CT1860-28	\$3,064
------------	----	----	----	-----	----	-----------	---------

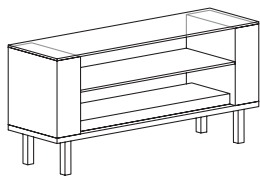

- glass top and shelf
- freestanding application

To Order, Specify:

- ① Model Number
- ② Wood Species - Cherry (CH1), Maple (MA1) or Walnut (WA1)
- ③ Wood Finish
- ④ Metal Color - Black Sandtex (BSX), Soft Nickel (SNK) or Stardust Silver (STS)

⑤ Wood Finish Options:

- Cherry**
- AUT Autumn
 - BRL Barley
 - BRG Brighton
 - BBN Bourbon
 - CLA Classic
 - EAR Earthy
 - LGC Legacy
 - PRL Praline
 - SAF Saffron
- Walnut**
- AUB Auburn
 - ESP Espresso
 - MCH Mocha
 - NTO Night owl
 - TOF Toffee
 - TRF Truffle
 - SIE Sienna

- Maple**
- ALE Ale
 - BUT Butterscotch
 - CIN Cinnamon
 - FLX Flax
 - VEN Venetian

Specifications

- Wood species - Cherry, Maple or Walnut.
- Plywood construction with locking tenons, glue and screws.
- Metal legs are 16 gauge steel tube with metal leveling glides.

Encore Lounge Tables Order Check List:



Specify:

- 1. Model Number
- 2. Wood Species - Maple (M)
- 3. Wood Finish
- 4. Leg Style - Table Disk Leg or Lounge Column Leg
- 5. Leg Color - Black Sandtex (BSX) or Stardust Silver (STS)
- 6. Optional Coordinating Wood Grain Laminate Surfaces - no upcharge

Example:

EN2142 | M | AUB | COLUMN | BLACK SANDTEX
 (model #) | (wood species) | (finish) | (leg style) | (leg color)

1. Model Number

2. Wood Species - Maple (M)

3. Wood Finish Options:

ALE Ale*	FLX Flax
AUB Auburn*	LGC Legacy*
AUT Autumn*	MCH Mocha*
BRL Barley*	NTO Night Owl*
BBN Bourbon*	PRL Praline*
BRG Brighton*	SAF Saffron*
BUT Butterscotch	SIE Sienna*
CIN Cinnamon*	TOF Toffee*
CLA Classic*	TRF Truffle*
EAR Earthy	VEN Venetian*
ESP Espresso	

4. Leg Style Options

Table Leg Style



Table Disk Leg
adjustable height glide
nylon glide



Lounge Column Leg
fixed height
nylon glide

5. Leg color - Black Sandtex (BSX) or Stardust Silver (STS)

6. Optional Coordinating Wood Grain Laminate Table Top -
 no upcharge. Finishes with an asterisk (*) have a coordinating
 laminate available.

Description	D	W	H	CTN WT	CU FT	1 Model	List Price
Oval Magazine Table	21 1/2	42 1/2	17	25	3	EN2142	\$1,017

NOW!

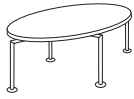

Round Magazine Table	36 1/2	36 1/2	17	28	4	EN36R	\$944
	30 1/2	30 1/2	17	25	3	EN30R	\$919

NOW!



Rectangular Magazine Table	24 1/2	48 1/2	17	30	4	EN2448	\$889
----------------------------	--------	--------	----	----	---	--------	-------

NOW!

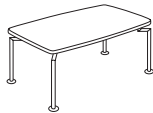

Square End Table	30 3/4	30 3/4	22 1/4	25	3	EN3030-22	\$861
	24 3/4	24 3/4	22 1/4	20	3	EN2424-22	\$748

NOW!

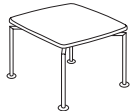

Square Magazine Table	30 3/4	30 3/4	17	25	3	EN3030-17	\$839
	24 3/4	24 3/4	17	20	3	EN2424-17	\$729

NOW!

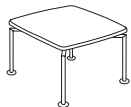

To Order, Specify:

- 1 Model Number
- 2 Wood Species - Maple (M)
- 3 Wood Finish
- 4 Leg Style - Table Disk or Lounge Column
- 5 Leg Color - Black Sandtex (BSX) or Stardust Silver (STS)
- 6 Optional Coordinating Wood Grain Laminate Available on Table top - no upcharge. Finishes with an asterisk have a coordinating laminate available.

3 Wood Finish Options:

ALE Ale*	FLX Flax
AUB Auburn*	LGC Legacy*
AUT Autumn*	MCH Mocha*
BRL Barley*	NTO Night Owl*
BBN Bourbon*	PRL Praline*
BRG Brighton*	SAF Saffron*
BUT Butterscotch	SIE Sienna*
CIN Cinnamon*	TOF Toffee*
CLA Classic*	TRF Truffle*
EAR Earthy	VEN Venetian*
ESP Espresso	

Specifications

- Wood species - Maple.
- Table tops are 3/4" thick.
- Tables ship KD; some assembly required.
- Standard with nylon glides.

When ordering Quickship products, place a "Q" in front of model number.
Example: QGT4901D

NOW!
Need it.
JSI Quickship

Finale Occasional Tables Order Check List:



Specify:

- 1. Model Number
- 2. Wood Species - Cherry (CH1), Maple (MA1) or Walnut (WA1)
- 3. Wood Finish
- 4. Wood Edge Profile
- 5. Metal Color - Black Sandtex (BSX), Soft Nickel (SNK) or Stardust Silver (STS)
- 6. Product Options

Example:

FN1860ST | **CH1** | **AUT** | **B**
 (model #) | (wood species) | (finish) | (edge)

1. Model Number

2. Wood Species - Cherry (CH1), Maple (MA1) or Walnut (WA1)

3. Wood Finish Options:

Cherry

AUT	Autumn*	EAR	Earthy
BRL	Barley*	LGC	Legacy*
BBN	Bourbon*	PRL	Praline*
BRG	Brighton*	SAF	Saffron*
CLA	Classic*		

Maple

ALE	Ale*	FLX	Flax
BUT	Butterscotch	VEN	Venetian*
CIN	Cinnamon*		

Walnut

AUB	Auburn*	SIE	Sienna*
ESP	Espresso	TOF	Toffee*
MCH	Mocha*	TRF	Truffle*
NTO	Night Owl*		

4. Wood Edge Profile Options:

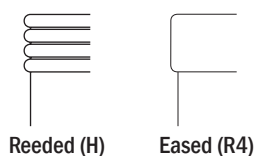
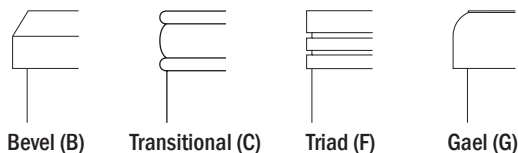

6. Product Options:

- High Pressure Laminate Top: No additional upcharge (For standard matching wood grain laminates only)
- Sheen Modification: 15% upcharge (For Top ONLY)
- Change Veneer Species: 40% upcharge (For oak or walnut only)

NOTE: Any specials or modifications must be accompanied by quote and approved drawing.

See additional Finale product in our JSI Casegoods and JSI Conference Price Lists.

Quickship items are available in Cherry veneer.

5. Metal Color - Black Sandtex (BSX), Satin Nickel (SNK) or Stardust Silver (STS)

Description	D	W	H	CTN WT	CU FT	1 Model	List Price
Comer Table	36	36	17	79	5	FN3636CT	\$878

NOW!

· ships KD in one carton



Sofa Table	18	60	30	66	4	FN1860ST	\$893
------------	----	----	----	----	---	----------	-------

NOW!

· ships KD in one carton

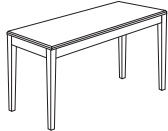

Magazine Table	20	42	16	51	4	FN2042MT	\$753
----------------	----	----	----	----	---	----------	-------

NOW!

· ships KD in one carton

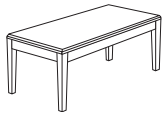

End Table	24	24	20	35	3	FN2424ET	\$637
-----------	----	----	----	----	---	----------	-------

NOW!

· ships KD in one carton

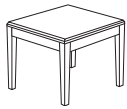

End Table	20	28	20	35	3	FN2028ET	\$634
-----------	----	----	----	----	---	----------	-------

NOW!

· ships KD in one carton

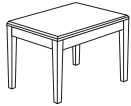

To Order, Specify:

- 1 Model Number
- 2 Wood Species - Cherry (CH1), Maple (MA1) or Walnut (WA1)
- 3 Wood Finish
- 4 Wood Edge Profile
- 5 Metal Color - Black Sandtex (BSX), Satin Nickel (SNK) or Stardust Silver (STS)
- 6 Product Options

3 Wood Finish Options:

Cherry

AUT	Autumn*	EAR	Earthy
BRL	Barley*	LGC	Legacy*
BBN	Bourbon*	PRL	Praline*
BRG	Brighton*	SAF	Saffron*
CLA	Classic*		

Maple

ALE	Ale*	FLX	Flax
BUT	Butterscotch	VEN	Venetian*
CIN	Cinnamon*		

Walnut

AUB	Auburn*	SIE	Sienna*
ESP	Espresso	TOF	Toffee*
MCH	Mocha*	TRF	Truffle*
NTO	Night owl*		

Specifications

- Wood species - Cherry, Maple or Walnut.
- Six edge details available.
- Tables ship KD; some assembly required.
- Tops feature a multi-step, semi-open pore finish with a satin finish.

4 Wood Edge Profile Options:

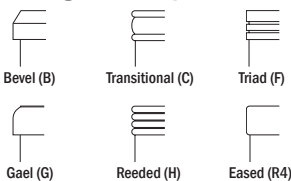

When ordering Quickship products, place a "Q" in front of model number.
Example: QV3072DD

NOW!
Need it.
JSI Quickship

Description	D	W	H	CTN WT	CU FT	① Model	List Price
Round Magazine Table	42	42	16			FN42MTD	\$1,863



Consists of:

FN42TT Table Top	56	5				\$1,111
FN18-16RB Round Base	68	5				\$752

- ships KD in two cartons

Round Magazine Table	36	36	16			FN36MTD	\$1,730
----------------------	----	----	----	--	--	---------	---------



Consists of:

FN36TT Table Top	42	4				\$978
FN18-16RB Round Base	68	5				\$752

- ships KD in two cartons

Metal End Table	24	24	20	51	10	FN2424G-20	\$1,852
-----------------	----	----	----	----	----	------------	---------

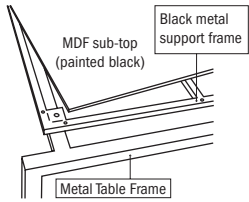

- with glass top
- metal 1 1/2" square tube frame - specify metal color option; Black Sandtex (BSX), Soft Nickel (SNK) or Stardust Silver (STS)
- white glass top
- glass top crated for shipment
- field assembly of glass top to metal base frame
- 1/2" tempered glass top

Metal End Table	24	24	20	51	10	FN2424V-20	\$1,834
-----------------	----	----	----	----	----	------------	---------

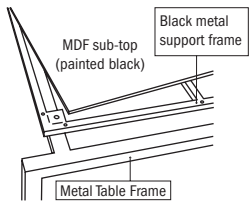

- with veneer top
- metal 1 1/2" square tube frame - specify metal color option; Black Sandtex (BSX), Soft Nickel (SNK) or Stardust Silver (STS)
- black support for veneer top - specify veneer top finish
- field assembly of veneer top to metal base frame
- wood species, finish and edge profile must be specified

Metal End Table	24	24	20	51	10	FN2424X-20	\$1,815
-----------------	----	----	----	----	----	------------	---------

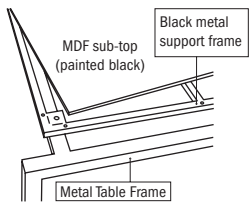

- for COM top
- includes: table frame, black metal support and black MDF subtop
- CUSTOMER MUST SUPPLY WORK SURFACE, INSTALLATION AT FINAL DESTINATION
- metal 1 1/2" square tube frame - specify metal color option; Black Sandtex (BSX), Soft Nickel (SNK) or Stardust Silver (STS)
- black support for COM top
- field assembly of COM top to metal base frame

OCCASIONAL TABLES

Description	D	W	H	CTN WT	CU FT	① Model	List Price
Metal Magazine Table	36	36	17	80	18	FN3636G-17	\$2,293

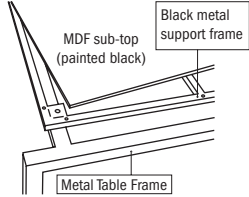

- with glass top
- metal 1 1/2" square tube frame - specify metal color option; Black Sandtex (BSX), Soft Nickel (SNK) or Stardust Silver (STS)
- white glass top
- glass top crated for shipment
- field assembly of glass top to metal base frame
- 1/2" tempered glass top

Metal Magazine Table	36	36	17	80	18	FN3636V-17	\$2,272
-----------------------------	----	----	----	----	----	-------------------	----------------

NOW!

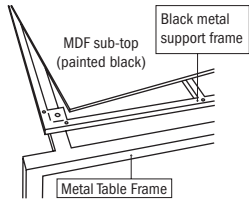

- with veneer top
- metal 1 1/2" square tube frame - specify metal color option; Black Sandtex (BSX), Soft Nickel (SNK) or Stardust Silver (STS)
- black support for veneer top - specify veneer top finish
- field assembly of veneer top to metal base frame
- wood species, finish and edge profile must be specified

Metal Magazine Table	36	36	17	80	18	FN3636X-17	\$2,249
-----------------------------	----	----	----	----	----	-------------------	----------------

NOW!

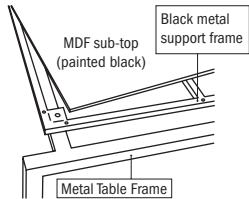

- for COM top
- includes: table frame, black metal support and black MDF subtop
- CUSTOMER MUST SUPPLY WORK SURFACE, INSTALLATION AT FINAL DESTINATION
- metal 1 1/2" square tube frame - specify metal color option; Black Sandtex (BSX), Soft Nickel (SNK) or Stardust Silver (STS)
- black support for COM top
- field assembly of COM top to metal base frame

To Order, Specify:

- ① Model Number
- ② Wood Species - Cherry (CH1), Maple (MA1) or Walnut (WA1)
- ③ Wood Finish
- ④ Wood Edge Profile
- ⑤ Metal Color - Black Sandtex (BSX), Satin Nickel (SNK) or Stardust Silver (STS)
- ⑥ Product Options

③ Wood Finish Options:

- Cherry**
- | | |
|---------------|--------------|
| AUT Autumn* | EAR Earthy |
| BRL Barley* | LGC Legacy* |
| BBN Bourbon* | PRL Praline* |
| BRG Brighton* | SAF Saffron* |
| CLA Classic* | |
- Maple**
- | | |
|------------------|---------------|
| ALE Ale* | FLX Flax |
| BUT Butterscotch | VEN Venetian* |
| CIN Cinnamon* | |
- Walnut**
- | | |
|----------------|--------------|
| AUB Auburn* | SIE Sienna* |
| ESP Espresso | TOF Toffee* |
| MCH Mocha* | TRF Truffle* |
| NTO Night owl* | |

Specifications

- Wood species - Cherry, Maple or Walnut.
- Six edge details available.
- Tables ship KD; some assembly required.
- Tops feature a multi-step, semi-open pore finish with a satin finish.

④ Wood Edge Profile Options:

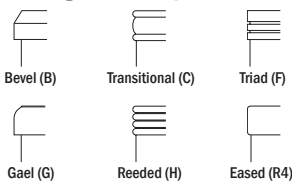

When ordering Quickship products, place a "Q" in front of model number.
Example: QV3072DD

NOW!
Need it.
JSI Quickship

Description	D	W	H	CTN WT	CU FT	① Model	List Price
Metal Magazine Table	24	48	17	81	16	FN2448G-17	\$2,167



- with glass top
- metal 1 1/2" square tube frame - specify metal color option; Black Sandtex (BSX), Soft Nickel (SNK) or Stardust Silver (STS)
- white glass top
- glass top crated for shipment
- field assembly of glass top to metal base frame
- 1/2" tempered glass top

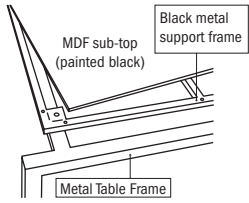

Metal Magazine Table	24	48	17	81	16	FN2448V-17	\$2,145
-----------------------------	----	----	----	----	----	-------------------	----------------

NOW!



- with veneer top
- metal 1 1/2" square tube frame - specify metal color option; Black Sandtex (BSX), Soft Nickel (SNK) or Stardust Silver (STS)
- black support for veneer top - specify veneer top finish
- field assembly of veneer top to metal base frame
- wood species, finish and edge profile must be specified

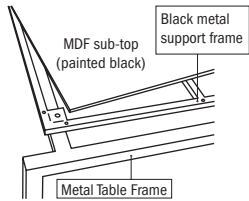

Metal Magazine Table	24	48	17	81	16	FN2448X-17	\$2,124
-----------------------------	----	----	----	----	----	-------------------	----------------

NOW!



- for COM top
- includes: table frame, black metal support and black MDF subtop
- CUSTOMER MUST SUPPLY WORK SURFACE, INSTALLATION AT FINAL DESTINATION
- metal 1 1/2" square tube frame - specify metal color option; Black Sandtex (BSX), Soft Nickel (SNK) or Stardust Silver (STS)
- black support for COM top
- field assembly of COM top to metal base frame

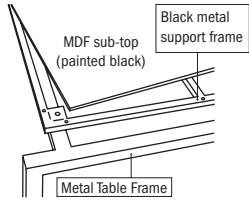

OCCASIONAL TABLES

To Order, Specify:

- ① Model Number
- ② Wood Species - Cherry (CH1), Maple (MA1) or Walnut (WA1)
- ③ Wood Finish
- ④ Wood Edge Profile
- ⑤ Metal Color - Black Sandtex (BSX), Satin Nickel (SNK) or Stardust Silver (STS)
- ⑥ Product Options

③ Wood Finish Options:

- Cherry**
- | | |
|---------------|--------------|
| AUT Autumn* | EAR Earthy |
| BRL Barley* | LGC Legacy* |
| BBN Bourbon* | PRL Praline* |
| BRG Brighton* | SAF Saffron* |
| CLA Classic* | |
- Maple**
- | | |
|------------------|---------------|
| ALE Ale* | FLX Flax |
| BUT Butterscotch | VEN Venetian* |
| CIN Cinnamon* | |
- Walnut**
- | | |
|----------------|--------------|
| AUB Auburn* | SIE Sienna* |
| ESP Espresso | TOF Toffee* |
| MCH Mocha* | TRF Truffle* |
| NTO Night owl* | |

Specifications

- Wood species - Cherry, Maple or Walnut.
- Six edge details available.
- Tables ship KD; some assembly required.
- Tops feature a multi-step, semi-open pore finish with a satin finish.

④ Wood Edge Profile Options:

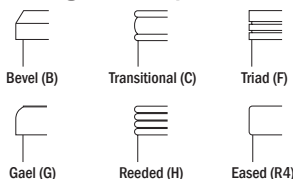

When ordering Quickship products, place a "Q" in front of model number.
Example: QW3072DD

NOW!
Need it.
JSI Quickship

Finn Lounge Occasional Tables Order Check List:



Specify:

- 1. Model Number
- 2. Wood Species - Cherry (C), Maple (M), White Oak (O) or Walnut (W)
- 3. Wood Finish

Example:

FI2424G | C | CLC
 (model #) | (wood species) | (finish)

1. Model Number

2. Wood Species - Cherry (C), Maple (M), White Oak (O), or Walnut (W)

3. Wood Finish:

- CLC Clear on Cherry
- CLM Clear on Maple
- CLK Clear on White Oak
- CLW Clear on Walnut

Description	D	W	H	CTN WT	CU FT	① Model	List Price
End Table	24	24	16	40	7	FI2424G	\$1,679



- glass top
- white back painted glass

End Table	28	20	16	39	7	FI2028G	\$1,691
-----------	----	----	----	----	---	---------	---------



- glass top
- white back painted glass

Coffee Table	42	42	16	111	20	FI4242G	\$2,870
--------------	----	----	----	-----	----	---------	---------

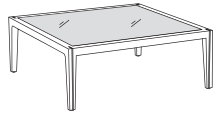

- glass top
- white back painted glass

Coffee Table	24	50	16	77	14	FI2450G	\$2,315
--------------	----	----	----	----	----	---------	---------

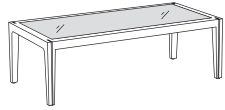

- glass top
- white back painted glass

Coffee Table	24	60	16	91	17	FI2460G	\$2,949
--------------	----	----	----	----	----	---------	---------

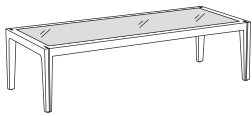

- glass top
- white back painted glass

OCCASIONAL TABLES

Description	D	W	H	CTN WT	CU FT	① Model	List Price
End Table	24	24	16	24	7	FI2424W	\$1,568



- wood top
- parquet veneer face

End Table	28	20	16	24	7	FI2028W	\$1,588
-----------	----	----	----	----	---	---------	---------



- wood top
- parquet veneer face

Coffee Table	42	42	16	62	20	FI4242W	\$2,238
--------------	----	----	----	----	----	---------	---------



- wood top
- parquet veneer face

Coffee Table	24	50	16	45	14	FI2450W	\$1,958
--------------	----	----	----	----	----	---------	---------



- wood top
- parquet veneer face

Coffee Table	24	60	16	52	17	FI2460W	\$2,486
--------------	----	----	----	----	----	---------	---------



- wood top
- parquet veneer face

To Order, Specify:

- ① Model Number
- ② Wood Species - Cherry (C), Maple (M), White Oak (O) or Walnut (W)
- ③ Wood Finish

③ Wood Finish Options:

- CLC Clear on Cherry
- CLM Clear on Maple
- CLK Clear on White Oak
- CLW Clear on Walnut

Specifications

- Wood species - Cherry, Maple, White Oak or Walnut in clear finish.
- Internal aluminum core throughout the legs.
- Standard with nylon glides.

Finn Nu Lounge Occasional Tables Order Check List:



Specify:

- 1. Model Number
- 2. Wood Species - Maple (M)
- 3. Wood Finish

Example:

F12424PG | **M** | **AUB**
 (model #) | (wood species) | (finish)

1. Model Number

2. Wood Species - Maple (M)

3. Wood Finish Options:

ALE Ale	FLX Flax
AUB Auburn	LGC Legacy
AUT Autumn	MCH Mocha
BRL Barley	NTO Night Owl
BBN Bourbon	PRL Praline
BRG Brighton	SAF Saffron
BUT Butterscotch	SIE Sienna
CIN Cinnamon	TOF Toffee
CLA Classic	TRF Truffle
EAR Earthy	VEN Venetian
ESP Espresso	

Description	D	W	H	CTN WT	CU FT	① Model	List Price
End Table	24	24	16	40	8	FI2424PG	\$1,199



- glass top
- white back painted glass

End Table	28	20	16	39	7	FI2028PG	\$1,197
-----------	----	----	----	----	---	----------	---------



- glass top
- white back painted glass

Coffee Table	42	42	16	111	21	FI4242PG	\$2,208
--------------	----	----	----	-----	----	----------	---------



- glass top
- white back painted glass

Coffee Table	24	50	16	77	15	FI2450PG	\$1,714
--------------	----	----	----	----	----	----------	---------

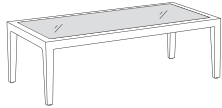

- glass top
- white back painted glass

Coffee Table	24	60	16	91	17	FI2460PG	\$1,882
--------------	----	----	----	----	----	----------	---------

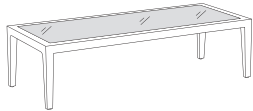

- glass top
- white back painted glass

To Order, Specify:

- ① Model Number
- ② Wood Species - Maple (M)
- ③ Wood Finish

③ Wood Finish Options:

ALE	Ale	FLX	Flax
AUB	Auburn	LGC	Legacy
AUT	Autumn	MCH	Mocha
BRL	Barley	NTO	Night Owl
BBN	Bourbon	PRL	Praline
BRG	Brighton	SAF	Saffron
BUT	Butterscotch	SIE	Sienna
CIN	Cinnamon	TOF	Toffee
CLA	Classic	TRF	Truffle
EAR	Earthy	VEN	Venetian
ESP	Espresso		

Specifications

- Wood species - Maple.
- Standard with nylon glides.

Description	D	W	H	CTN WT	CU FT	① Model	List Price
End Table	24	24	16	24	8	FI2424PW	\$1,042



- wood top
- bookmatch maple veneer

End Table	28	20	16	24	7	FI2028PW	\$1,052
-----------	----	----	----	----	---	----------	---------



- wood top
- bookmatch maple veneer

Coffee Table	42	42	16	62	21	FI4242PW	\$1,382
--------------	----	----	----	----	----	----------	---------



- wood top
- bookmatch maple veneer

Coffee Table	24	50	16	45	15	FI2450PW	\$1,241
--------------	----	----	----	----	----	----------	---------



- wood top
- bookmatch maple veneer

Coffee Table	24	60	16	52	17	FI2460PW	\$1,272
--------------	----	----	----	----	----	----------	---------



- wood top
- bookmatch maple veneer

OCCASIONAL TABLES

To Order, Specify:

- ① Model Number
- ② Wood Species - Maple (M)
- ③ Wood Finish

③ Wood Finish Options:

ALE Ale	FLX Flax
AUB Auburn	LGC Legacy
AUT Autumn	MCH Mocha
BRL Barley	NTO Night Owl
BBN Bourbon	PRL Praline
BRG Brighton	SAF Saffron
BUT Butterscotch	SIE Sienna
CIN Cinnamon	TOF Toffee
CLA Classic	TRF Truffle
EAR Earthy	VEN Venetian
ESP Espresso	

Specifications

- Wood species - Maple.
- Standard with nylon glides.

Focus Lounge Occasional Tables Order Check List:



Specify:

- 1. Model Number
- 2. Wood Species - Maple (M)
- 3. Wood Finish

Example:

OCFT4436-15 | **M** | **AUB** |
 (model #) | (wood species) | (finish) |

1. Model Number

2. Wood Species - Maple (M)

3. Wood Finish Options:

ALE Ale	FLX Flax
AUB Auburn	LGC Legacy
AUT Autumn	MCH Mocha
BRL Barley	NTO Night Owl
BBN Bourbon	PRL Praline
BRG Brighton	SAF Saffron
BUT Butterscotch	SIE Sienna
CIN Cinnamon	TOF Toffee
CLA Classic	TRF Truffle
EAR Earthy	VEN Venetian
ESP Espresso	

Description	D	W	H	CTN WT	CU FT	① Model	List Price
Coffee Table	36	36	15	37	15	OCFT4436-15	\$1,725

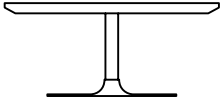

22" H End Table	24	24	22	27	10	ORT4424-22	\$1,293
-----------------	----	----	----	----	----	------------	---------

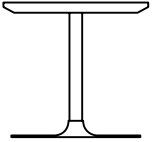

15" H End Table	24	24	15	25	7	ORT4424-15	\$1,278
-----------------	----	----	----	----	---	------------	---------

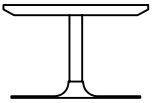

OCCASIONAL TABLES

To Order, Specify:

- ① Model Number
- ② Wood Species - Maple (M)
- ③ Wood Finish

③ Wood Finish Options:

ALE Ale	FLX Flax
AUB Auburn	LGC Legacy
AUT Autumn	MCH Mocha
BRL Barley	NTO Night Owl
BBN Bourbon	PRL Praline
BRG Brighton	SAF Saffron
BUT Butterscotch	SIE Sienna
CIN Cinnamon	TOF Toffee
CLA Classic	TRF Truffle
EAR Earthy	VEN Venetian
ESP Espresso	

Specifications

- Wood species - Maple.
- Column pedestal is Polished Aluminum with nylon glides.

Hedron Lounge Occasional Tables Order Check List:



Specify:

- 1. Model Number
- 2. Wood Species - Maple (M)
- 3. Wood Finish
- 4. Optional Veneer Wrapped Leg (V) - add \$216 list
- 5. Optional Coordinating Wood Grain Laminate Surfaces - no upcharge
- 6. Optional Felt Glide Covers - no upcharge

Example:

HN2424-17 | M | AUB
 (model #) | (wood species) | (finish)

1. Model Number

2. Wood Species - Maple (M)

3. Wood Finish Options:

ALE Ale*	FLX Flax
AUB Auburn*	LGC Legacy*
AUT Autumn*	MCH Mocha*
BRL Barley*	NTO Night Owl*
BBN Bourbon*	PRL Praline*
BRG Brighton*	SAF Saffron*
BUT Butterscotch	SIE Sienna*
CIN Cinnamon*	TOF Toffee*
CLA Classic*	TRF Truffle*
EAR Earthy	VEN Venetian*
ESP Espresso	

4. Optional Veneer Wrapped Leg (V) - add \$216 list

***5. Optional Coordinating Wood Grain Laminate Table Top - no upcharge. Finishes with an asterisk (*) have a coordinating laminate available.**

8. Optional Feet Glide Covers - no upcharge

Description	D	W	H	CTN WT	CU FT	① Model	List Price
24" x 24" End Table	24 3/4	24 3/4	17	27	6	HN2424-17	\$703

NOW!

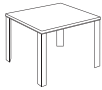

30" x 30" End Table	28 1/4	28 1/4	17	33	6	HN3030-17	\$819
---------------------	--------	--------	----	----	---	-----------	-------

NOW!

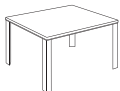

36" x 36" End Table	36	36	17	46	8	HN3636-17	\$874
---------------------	----	----	----	----	---	-----------	-------

NOW!



OCCASIONAL TABLES

To Order, Specify:

- ① Model Number
- ② Wood Species - Maple (M)
- ③ Wood Finish
- ④ Optional Veneer Wrapped Legs (V) - add \$216 list
- ⑤ Optional Coordinating Wood Grain Laminate - no upcharge. Finishes with an asterisk have a coordinating laminate available.
- ⑥ Optional Felt Glide Covers - no upcharge

③ Wood Finish Options:

ALE	Ale*	FLX	Flax
AUB	Auburn*	LGC	Legacy*
AUT	Autumn*	MCH	Mocha*
BRL	Barley*	NTO	Night Owl*
BBN	Bourbon*	PRL	Praline*
BRG	Brighton*	SAF	Saffron*
BUT	Butterscotch	SIE	Sienna*
CIN	Cinnamon*	TOF	Toffee*
CLA	Classic*	TRF	Truffle*
EAR	Earthy	VEN	Venetian*
ESP	Espresso		

Specifications

- Wood species - Maple
- Table tops are 7/8" thick.
- Anodized aluminum extruded leg.
- Standard with nylon glides.

When ordering Quickship products, place a "Q" in front of model number.
Example: QGT4901D

NOW!
Need it.
JSI Quickship

Laurel Occasional Tables Order Check List:



Specify:

- 1. Model Number
- 2. Wood Species - Maple (M)
- 3. Wood Finish
- 4. Optional Coordinating Wood Grain Laminate Table Tops - no upcharge

Example:

LA2424ET (model #)	M (wood species)	AUB (finish)
------------------------------	----------------------------	------------------------

1. Model Number

2. Wood Species - Maple (M)

3. Wood Finish Options:

ALE Ale*	FLX Flax
AUB Auburn*	CGR Graphite Coordinate
AUT Autumn*	CHL High Line Coordinate*
BRL Barley*	CKC Khaki Coordinate
CBE Blonde Echo Coordinate*	LGC Legacy*
BBN Bourbon*	MCH Mocha*
CBZ Brazilwood Coordinate*	NTO Night Owl*
BRG Brighton*	PRL Praline*
BUT Butterscotch	SAF Saffron*
CIN Cinnamon*	SIE Sienna*
CLA Classic*	CST Studio Teak Coordinate*
CCF Coffee Coordinate	TOF Toffee*
CCR Cremello Coordinate	TRF Truffle*
EAR Earthy	VEN Venetian*
ESP Espresso	CWH Walnut Heights Coordinate*

4. Optional Coordinating Wood Grain Laminate Table Tops - no upcharge. Finishes with an asterisk (*) have a coordinating laminate available.

Description	D	W	H	CTN WT	CU FT	① Model	List Price
End Table	24	24	17	25	4	LA2424ET	\$637

NOW!

- maple veneer top
- ships KD

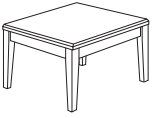

End Table	30	30	17	40	6	LA3030ET	\$746
-----------	----	----	----	----	---	----------	-------

NOW!

- maple veneer top
- ships KD

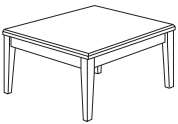

Magazine Table	20	42	17	45	6	LA2042MT	\$753
----------------	----	----	----	----	---	----------	-------

NOW!

- maple veneer top
- ships KD

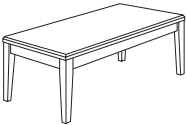

Corner Table	36	36	17	50	8	LA3636CT	\$878
--------------	----	----	----	----	---	----------	-------

NOW!

- maple veneer top
- ships KD

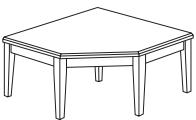

OCCASIONAL TABLES

To Order, Specify:

- ① Model Number
- ② Wood Species - Maple (M)
- ③ Wood Finish
- ④ Optional Coordinating Wood Grain Laminate
Table Tops - no upcharge; tables only. Finishes with an asterisk have a coordinating laminate available.

③ Wood Finish Options:

ALE Ale*	FLX Flax
AUB Auburn*	CGR Graphite Coordinate
AUT Autumn*	CHL High Line Coordinate*
BRL Barley*	CKC Khaki Coordinate
CBE Blonde Echo Coordinate*	LGC Legacy*
BBN Bourbon*	MCH Mocha*
CBZ Brazilwood Coordinate*	NTO Night Owl*
BRG Brighton*	PRL Praline*
BUT Butterscotch	SAF Saffron*
CIN Cinnamon*	SIE Sienna*
CLA Classic*	CST Studio Teak Coordinate*
CCF Coffee Coordinate	TOF Toffee*
CCR Cremello Coordinate	TRF Truffle*
EAR Earthy	VEN Venetian*
ESP Espresso	CWH Walnut Heights Coordinate*

Specifications

- Wood species - Maple veneer (tables).
- Top core material is 1 1/8" thick with 45 lb. density industrial grade particle board.
- Face is wood veneer or .050 horizontal grade HPL.
- Backer is bonded to bottom side to ensure balanced construction.
- All tops have internal solid lumber bands with overlay laminate or veneer.

When ordering Quickship products, place a "Q" in front of model number.
Example: QGT4901D



Luci Occasional Tables Order Check List:



Specify:

- 1. Model Number
- 2. Wood Species - Maple (M)
- 3. Wood Finish/Color

Example:

LU36RT | **M** | **AUB**
 (model #) | (wood species) | (finish)

1. Model Number

2. Wood Species - Maple (M)

3. Wood Finish/Color Options:

- | | |
|------------------|---------------|
| ALE Ale | FLX Flax |
| AUB Auburn | LGC Legacy |
| AUT Autumn | MCH Mocha |
| BRL Barley | NTO Night Owl |
| BBN Bourbon | PRL Praline |
| BRG Brighton | SAF Saffron |
| BUT Butterscotch | SIE Sienna |
| CIN Cinnamon | TOF Toffee |
| CLA Classic | TRF Truffle |
| EAR Earthy | VEN Venetian |
| ESP Espresso | |

Color - Add \$31 list per item

- | | |
|------------------|----------------------|
| BKD Backdrop | GRV Greek Villa |
| BFX Black Fox | GLF Gulf Stream |
| BWH Bright White | HTB Heartthrob |
| CGP Cargo Pants | NET Network Gray |
| CHT Chatroom | NWH Nonchalant White |
| DSY Daisy | PAR Paradise |
| DRG Daring | QXP Quixotic Plum |
| DYN Dynamo | RBZ Relic Bronze |
| ENG Enigma | SND Sandbank |
| FRR French Roast | STM Storm |
| GBY Georgian Bay | TRC Tricorn Black |

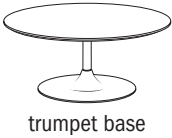
Description	D	W	H	CTN WT	CU FT	① Model	List Price
 trumpet base	36	36	15 5/8	37	15	LU36RT	\$677
	30	30	15 5/8	31	11	LU30RT	\$630

- polished aluminum base
- reverse beveled edge profile
- 23" base diameter

 4-prong base	36	36	15 5/8	37	15	LU36RX	\$942
	30	30	15 5/8	31	11	LU30RX	\$895

- polished aluminum base
- reverse beveled edge profile
- 23" base diameter

 trumpet base	36	36	15 5/8	41	15	LU3636ST	\$677
	30	30	15 5/8	34	11	LU3030ST	\$630

- polished aluminum base
- reverse beveled edge profile
- 23" base diameter

 4-prong base	36	36	15 5/8	41	15	LU3636SX	\$942
	30	30	15 5/8	34	11	LU3030SX	\$895

- polished aluminum base
- reverse beveled edge profile
- 23" base diameter

OCCASIONAL TABLES

To Order, Specify:

- ① Model Number
- ② Wood Species -Maple (M)
- ③ Wood Finish/Color

③ Wood Finish Options:

ALE Ale	FLX Flax
AUB Auburn	LGC Legacy
AUT Autumn	MCH Mocha
BRL Barley	NTO Night Owl
BBN Bourbon	PRL Praline
BRG Brighton	SAF Saffron
BUT Butterscotch	SIE Sienna
CIN Cinnamon	TOF Toffee
CLA Classic	TRF Truffle
EAR Earthy	VEN Venetian
ESP Espresso	

Specifications

- Wood species - Maple (M).
- Reverse bevel edge on table tops.
- All standard with rubber cushion nylon glides.

Color - Add \$31 list per item

BKD Backdrop	GRV Greek Villa
BFX Black Fox	GLF Gulf Stream
BWH Bright White	HTB Heartthrob
CGP Cargo Pants	NET Network Gray
CHT Chatroom	NWH Nonchalant White
DSY Daisy	PAR Paradise
DRG Daring	QXP Quixotic Plum
DYN Dynamo	RBZ Relic Bronze
ENG Enigma	SND Sandbank
FRR French Roast	STM Storm
GBY Georgian Bay	TRC Tricorn Black

Olympian Lounge Order Check List:



Specify:

- 1. Model Number
- 2. Wood Species - Maple (M)
- 3. Wood Finish
- 4. Optional Rubber Cushion Nylon Glides - no upcharge

Example:

OL2828-17 | M | AUB
 (model #) | (wood species) | (finish)

1. Model Number

2. Wood Species - Maple (M)

3. Wood Finish Options:

ALE Ale	FLX Flax
AUB Auburn	LGC Legacy
AUT Autumn	MCH Mocha
BRL Barley	NTO Night Owl
BBN Bourbon	PRL Praline
BRG Brighton	SAF Saffron
BUT Butterscotch	SIE Sienna
CIN Cinnamon	TOF Toffee
CLA Classic	TRF Truffle
EAR Earthy	VEN Venetian
ESP Espresso	

4. Optional Rubber Cushion Nylon Glides - no upcharge

Description	D	W	H	CTN WT	CU FT	① Model	List Price
28" x 28" End Table	28	28	17	30	6	OL2828-17	\$530

NOW!

· maple veneer top

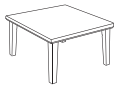

36" x 36" Magazine Table	36	36	17	40	8	OL3636-17	\$580
--------------------------	----	----	----	----	---	-----------	-------

NOW!

· maple veneer top

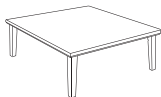

OCCASIONAL TABLES

To Order, Specify:

- ① Model Number
- ② Wood Species - Maple (M)
- ③ Wood Finish
- ④ Optional Rubber Cushion Nylon Glides - no upcharge

③ Wood Finish Options:

ALE Ale	FLX Flax
AUB Auburn	LGC Legacy
AUT Autumn	MCH Mocha
BRL Barley	NTO Night Owl
BBN Bourbon	PRL Praline
BRG Brighton	SAF Saffron
BUT Butterscotch	SIE Sienna
CIN Cinnamon	TOF Toffee
CLA Classic	TRF Truffle
EAR Earthy	VEN Venetian
ESP Espresso	

Specifications

- Wood species - Maple.
- Table tops are 1" thick maple veneer.
- Mortise and tenon construction with corner blocks, glue and screws.
- Standard with rubber cushion metal glides.

When ordering Quickship products, place a "Q" in front of model number.
Example: QGT4901D

NOW!
Need it.
JSI Quickship

Shuffle Occasional Tables Order Check List:



Specify:

- 1. Model Number
- 2. Wood Species - Cherry (CH1)
- 3. Wood Finish
- 4. Edge Profile
- 5. Product Options

Example:

SH1860ST | CH1 | PRL | C
(model #) | (wood species) | (finish) | (edge)

1. Model Number

2. Wood Species - Cherry (CH1)

3. Wood Finish Options:

AUT	Autumn Cherry*	EAR	Earthy
BRL	Barley*	LGC	Legacy*
BBN	Bourbon*	PRL	Praline*
BRG	Brighton*	SAF	Saffron*
CLA	Classic*		

5. Product Options:

- Sheen Modification: 15% upcharge (For Top Only)
- Change Veneer Species: 40% upcharge (For oak or maple only)[▲]
- Optional Coordinating Wood Grain Laminate Table Top: No upcharge. Finishes with an asterisk (*) have a coordinating laminate available.

NOTE: Any specials or modifications must be accompanied by quote and approved drawing.

4. Edge Profile Options:

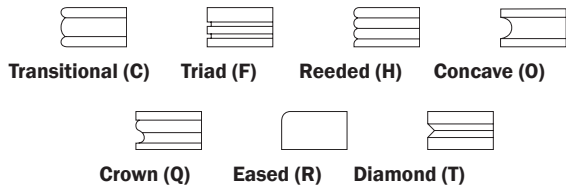

See additional Shuffle product in our JSI Casegoods and JSI Conference Price Lists.

Description	D	W	H	CTN WT	CU FT	① Model	List Price
Sofa Table	18	60	30	66	4	SH1860ST	\$893



· ships KD in one carton

Magazine Table	20	42	16	51	4	SH2042MT	\$753
----------------	----	----	----	----	---	----------	-------



· ships KD in one carton

End Table	24	24	20	35	3	SH2424ET	\$637
-----------	----	----	----	----	---	----------	-------



· ships KD in one carton

End Table	20	28	20	35	3	SH2028ET	\$634
-----------	----	----	----	----	---	----------	-------



· ships KD in one carton

Round Magazine Table	42	42	17			SH42MTD	\$1,863
----------------------	----	----	----	--	--	---------	---------



Consists of:

SH42TT	Table Top	56	5	\$1,111
SH18-16RB	Round Base	68	5	\$752

· ships KD in two cartons

Round Magazine Table	36	36	17			SH36MTD	\$1,730
----------------------	----	----	----	--	--	---------	---------



Consists of:

SH36TT	Table Top	42	4	\$978
SH18-16RB	Round Base	68	5	\$752

· ships KD in two cartons

To Order, Specify:

- ① Model Number
- ② Wood Species - Cherry (CH1)
- ③ Wood Finish
- ④ Edge Profile
- ⑤ Product Options

③ Wood Finish Options:

AUT	Autumn Cherry*	EAR	Earthy
BRL	Barley*	LGC	Legacy*
BBN	Bourbon*	PRL	Praline*
BRG	Brighton*	SAF	Saffron*
CLA	Classic*		

Specifications

- Wood species - Cherry.
- Tables ship KD.
- Tops feature a multi-step, semi-open pore finish with a satin finish.

④ Edge Profile Options:

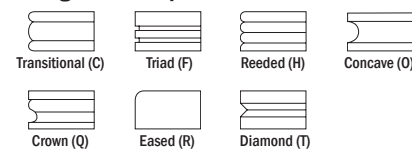

Solara Lounge Occasional Tables Order Check List:



Specify:

- 1. Model Number
- 2. Wood Species - Maple (M)
- 3. Wood Finish

Example:

OCFT7336-16 | M | AUB
 (model #) | (wood species) | (finish)

1. Model Number

2. Wood Species - Maple (M)

3. Wood Finish Options:

ALE Ale	FLX Flax
AUB Auburn	LGC Legacy
AUT Autumn	MCH Mocha
BRL Barley	NTO Night Owl
BBN Bourbon	PRL Praline
BRG Brighton	SAF Saffron
BUT Butterscotch	SIE Sienna
CIN Cinnamon	TOF Toffee
CLA Classic	TRF Truffle
EAR Earthy	VEN Venetian
ESP Espresso	

Description	D	W	H	CTN WT	CU FT	① Model	List Price
Coffee Table	36	36	16	46	16	OCFT7336-16	\$1,801



· ½" thick glass

Coffee Table	30	30	16	38	11	OCFT7330-16	\$1,670
--------------	----	----	----	----	----	-------------	---------

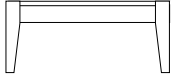

· ½" thick glass

Coffee Table	22	42	16	75	11	OCFT7342-16	\$1,664
--------------	----	----	----	----	----	-------------	---------

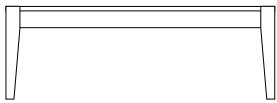

· ½" thick glass

Console Table	15	48	29	72	16	OCST7348-29	\$1,626
---------------	----	----	----	----	----	-------------	---------



· ½" thick glass

End Table	22	30	24	49	12	OET7330-24	\$1,384
-----------	----	----	----	----	----	------------	---------



· ½" thick glass

End Table	22	22	24	49	9	OST7322-24	\$1,231
-----------	----	----	----	----	---	------------	---------

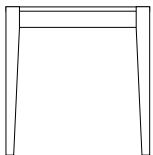

· ½" thick glass

OCCASIONAL TABLES

To Order, Specify:

- ① Model Number
- ② Wood Species - Maple (M)
- ③ Wood Finish

③ Wood Finish Options:

ALE Ale	FLX Flax
AUB Auburn	LGC Legacy
AUT Autumn	MCH Mocha
BRL Barley	NTO Night Owl
BBN Bourbon	PRL Praline
BRG Brighton	SAF Saffron
BUT Butterscotch	SIE Sienna
CIN Cinnamon	TOF Toffee
CLA Classic	TRF Truffle
EAR Earthy	VEN Venetian
ESP Espresso	

Specifications

- Frame is hardwood maple.
- Frosted glass tops with screen print on underside with finger print resistant coating.
- Glass is tempered.

Traditional Occasional Tables Order Check List:



Specify:

- 1. Model Number
- 2. Wood Species - Cherry (CH1) or Walnut (WA1)
- 3. Wood Finish
- 4. Product Options

Example:

ST8028 (model #)	CH1 (wood species)	AUT (finish)	
----------------------------	------------------------------	------------------------	--

1. Model Number

2. Wood Species - Cherry (CH1) or Walnut (WA1)

3. Wood Finish Options:

Cherry		Walnut	
AUT	Autumn*	AUB	Auburn*
BRL	Barley*	ESP	Espresso
BBN	Bourbon*	MCH	Mocha*
BRG	Brighton*	NTO	Night Owl*
CLA	Classic*	SIE	Sienna*
EAR	Earthy	TOF	Toffee*
LGC	Legacy*	TRF	Truffle*
PRL	Praline*		
SAF	Saffron*		

4. Product Options:

- Optional Coordinating Wood Grain Laminate Table Top: No upcharge. Finishes with an asterisk (*) have a coordinating laminate available.

NOTE: Any specials or modifications must be accompanied by quote and approved drawing.

Description	D	W	H	CTN WT	CU FT	① Model	List Price
Rectangular Coffee Table	20	48	16	65	12	COFTQS8048	\$1,444



· compliment Walden and Wellington series

Square End Table	28	28	23	35	13	STQS8028	\$1,229
------------------	----	----	----	----	----	----------	---------

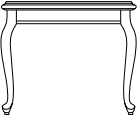

· compliment Walden and Wellington series

Rectangular End Table	18	28	23	25	9	ETQS8028	\$1,120
-----------------------	----	----	----	----	---	----------	---------

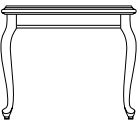

· compliment Walden and Wellington series

Rectangular Coffee Table	20	48	16	65	12	COFT8048	\$1,319
--------------------------	----	----	----	----	----	----------	---------



shown with
optional shelf

· compliment Walden and Wellington series
· optional shelf available, specify and add \$214 list

Square End Table	28	28	23	35	13	ST8028	\$1,122
------------------	----	----	----	----	----	--------	---------

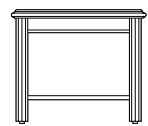

shown with
optional shelf

· compliment Walden and Wellington series
· optional shelf available, specify and add \$198 list

Rectangular End Table	18	28	23	25	9	ET8028	\$1,052
-----------------------	----	----	----	----	---	--------	---------

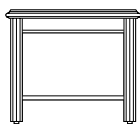

shown with
optional shelf

· compliment Walden and Wellington series
· optional shelf available, specify and add \$159 list

To Order, Specify:

- ① Model Number
- ② Wood Species - Cherry (CH1) or Walnut (WA1)
- ③ Wood Finish
- ④ Product Options

③ Wood Finish Options:

Cherry		Walnut	
AUT	Autumn*	AUB	Auburn*
BRL	Barley*	ESP	Espresso
BBN	Bourbon*	MCH	Mocha*
BRG	Brighton*	NTO	Night Owl*
CLA	Classic*	SIE	Sienna*
EAR	Earthy	TOF	Toffee*
LGC	Legacy*	TRF	Truffle*
PRL	Praline*		
SAF	Saffron*		

Specifications

- Wood species - Cherry or Walnut.
- Top is 1 1/4" thick.
- Veneer is reverse slip-matched.
- Shipped KD.

Ziva Tables Order Check List:



Specify:

- 1. Model Number
- 2. Top Material - Veneer or Glacier White Solid Surface
- 3. Wood Species - Cherry (CH1), Maple (MA1) or Walnut (WA1)
- 4. Wood Finish

Example:

OCFT6648-18 (model #)	VENEER (top material)	CH1 (wood species)	AUT (finish)
---------------------------------	---------------------------------	------------------------------	------------------------

1. Model Number

2. Top Material - Veneer or Glacier White Solid Surface

3. Wood Species - Cherry (CH1), Maple (MA1) or Walnut (WA1)

4. Wood Finish Options:

Cherry - Flat Cut

AUT Autumn
 BRL Barley
 BBN Bourbon
 BRG Brighton
 CLA Classic
 EAR Earthy
 LGC Legacy
 PRL Praline
 SAF Saffron

Maple - Flat Cut

ALE Ale
 BUT Butterscotch
 CIN Cinnamon
 FLX Flax
 VEN Venetian

Walnut - Flat Cut

AUB Auburn
 ESP Espresso
 MCH Mocha
 NTO Night Owl
 SIE Sienna
 TOF Toffee
 TRF Truffle

Description	D	W	H	CTN WT	CU FT	① Model	List Price
Coffee Table	24	48	18	51	15	OCFT6648-18	\$1,506

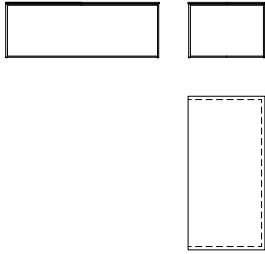

- Arctic Silver powder-coated frame
- Glacier White solid surface available, specify and add \$121 list

Coffee Table	30	30	18	42	12	OCFT6630-18	\$1,418
--------------	----	----	----	----	----	-------------	---------

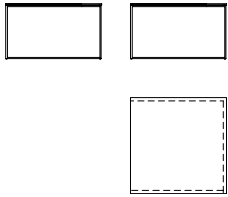

- Arctic Silver powder-coated frame
- Glacier White solid surface available, specify and add \$114 list

Half Round Coffee Table	24	48	18	45	15	ORCT6648-24-18	\$1,402
-------------------------	----	----	----	----	----	----------------	---------

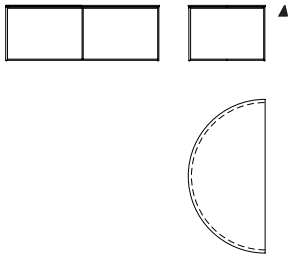

- Arctic Silver powder-coated frame
- Glacier White solid surface available, specify and add \$113 list

OCCASIONAL TABLES

To Order, Specify:

- ① Model Number
- ② Top Material - Veneer or Glacier White Solid Surface
- ③ Wood Species - Cherry (CH1), Maple (MA1) or Walnut (WA1)
- ④ Wood Finish

③ Wood Finish Options:

Cherry - Flat Cut

- AUT Autumn
- BRL Barley
- BBN Bourbon
- BRG Brighton
- CLA Classic
- EAR Earthy
- LGC Legacy
- PRL Praline
- SAF Saffron

Walnut - Flat Cut

- AUB Auburn
- ESP Espresso
- MCH Mocha
- NTO Night Owl
- SIE Sienna
- TOF Toffee
- TRF Truffle

Maple - Flat Cut

- ALE Ale
- BUT Butterscotch
- CIN Cinnamon
- FLX Flax
- VEN Venetian

Specifications

- Available in Cherry, Maple and Walnut veneer.

Index

AC6381C	79	BS1854-20TDSR	173	BS2448DCT	164	CC-MCS4536R	198
AC6381D	79	BS1854-20TFSL	173	BS2448GTT	165, 431	CC-MCS4572	197
AI3612	32	BS1854-20TFSR	173	BS2448OCT	164	CC-MCS4572-PS	197
AI3614	32	BS1854-20TOSL	172	BS2448SCTL	164	CC-MWB4566	199
AI3622	32	BS1854-20TOSR	172	BS2448SCTR	164	CC-SMT4569	196
AI3623	34	BS1854-27SDWL	169	BS2448WTT	165, 431	CC-SPS4563L	199
AI3624	33	BS1854-27SDWR	169	BS3	151	CC-SPS4563R	199
AI3625	34	BS1854-27SFSL	170	BS3636-12OCT	164	CC-TT4522	199
AI3626	33	BS1854-27SFSR	170	BS480	152	CL4561	180
AI3627	34	BS1854-27SOSL	169	BS480-120L	156	CL4566	178
AI3652	35	BS1854-27SOSR	169	BS480-120R	156	CL4568	179
AI3654	35	BS1854-27TFSL	174	BS480-122	159	CL4571	180
AI3696	35	BS1854-27TFSR	174	BS481L	154	CL4576	178
AI3698	36	BS1854-27THDL	174	BS481R	154	CL4576L	178
AN2800C	30	BS1854-27THDR	174	BS482	154	CL4576R	178
AN2800U	29	BS1854-27TOSL	174	BS482-120L	158	CL4581	180
AN2805C	29	BS1854-27TOSR	174	BS482-120R	158	CL4586	178
AN2805U	29	BS1854-33SFSL	171	BS482-122	160	CL4586L	179
AX1848-29	425	BS1854-33SFSR	171	BS4848GTT	165, 431	CL4586R	179
AX2028-22	423	BS1854-33SOSL	171	BS4848WTT	165, 431	CM4517	83, 191
AX2042-16	425	BS1854-33SOSR	171	BS500	153	CM4519	83, 191
AX23R-22	424	BS1854-33TFSL	175	BS500-120L	157	CM4527	191
AX2424-22	423	BS1854-33TFSR	175	BS500-120R	157	CM4531	190
AX2448-16	424	BS1854-33TOSL	175	BS501L	155	CM4550	188
AX29R-16	425	BS1854-33TOSR	175	BS501R	155	CM4552	188
AX29R-22	424	BS1872-16SDWL	167	BS502-120L	158	CM4552L	188
AX3030-16	424	BS1872-16SDWR	167	BS502-120R	158	CM4552R	188
AX3030-22	423	BS1872-16SFS	167	BS502L	156	CM4555	188
AX37R-16	425	BS1872-16SOS	166	BS502R	156	CM4572	189
AX4242-16	424	BS1872-20SDWL	168	BS720	152	CM4572-PS	190
BG1860ST	439	BS1872-20SDWR	168	BS720-120L	156	CM4575	189
BG2028ET	439	BS1872-20SFS	168	BS720-120R	156	CM4575-PS	190
BG2042MT	439	BS1872-20SOS	168	BS720-122	159	CM4585	189
BG2424ET	439	BS1872-20SOSR	173	BS721L	154	CM4585-PS	190
BN1848-29	429	BS1872-20TFSR	173	BS721R	154	COFT8048	474
BN2028-22	427	BS1872-20TOSL	172	BS722	154	COFTQS8048	474
BN2042-16	429	BS1872-20TOSR	172	BS722-120L	158	Contrasting Textile Center	36
BN23R-22	428	BS1872-20TSL	172	BS722-120R	158	CR1270	38
BN2424-22	427	BS1872-20TSR	172	BS722-122	160	CR1271	81
BN2448-16	428	BS1872-27SFS	170	BS740	153	CR1275	38
BN29R-16	429	BS1872-27SOS	169	BS740-120L	157	CT1717LTT	270
BN29R-22	428	BS1872-27SSL	170	BS740-120R	157	CT1860-28	269, 445
BN3030-16	428	BS1872-27SSR	170	BS741L	155	CT2060M	270
BN3030-22	427	BS1872-27TFSL	174	BS741R	155	CT2060MAS	270
BN37R-16	429	BS1872-27TFSR	174	BS742-120L	158	CT2060MC	270
BN4242-16	428	BS1872-27TOSL	174	BS742-120R	158	CT2060MCAS	270
BR1860ST	433	BS1872-27TOSR	174	BS742L	156	CT2448-15	269, 445
BR2028ET	433	BS1872-27TSL	174	BS742R	156	CT2322-22	269, 445
BR2042MT	433	BS1872-27TSR	174	BS750	151	CT3636-15	269, 445
BR2424ET	433	BS1872-33SFS	171	CB7501S	277	CT4242-15	269, 445
BR2424G-20	434	BS1872-33SOS	171	CB7501W	277	CT4848-15	269, 445
BR2424V-20	434	BS1872-33SSL	171	CB7502S	277	CT6072MACB	270
BR2424X-20	434	BS1872-33SSR	171	CB7502W	277	CT6072MACBW	271
BR2448G-17	436	BS1872-33TFSL	175	CB7503S	278	CT6072MACR	271
BR2448V-17	436	BS1872-33TFSR	175	CB7503W	278	CT6072MACRW	272
BR2448X-17	436	BS1872-33TOSL	175	CB7504S	278	CT6084MACB	270
BR3636G-17	434	BS1872-33TOSR	175	CB7504W	278	CT6084MACBW	271
BR3636V-17	435	BS1872-33TSL	175	CB7591S	278	CT6084MACR	271
BR3636X-17	435	BS1872-33TSR	175	CB7591W	278	CT6084MACRW	272
BR36MTD	437	BS2	150	CB7592S	279	CTC20S1UC	246
BR42MTD	437	BS2020GTT	165, 431	CB7592W	279	CTC20S1UR	246
BS1	150	BS2020WTT	165, 431	CB7593S	279	CTC20S2UC	247
BS1-S	150	BS230	150	CB7593W	279	CTC20S2UR	247
BS140	163	BS240	152	CC-FMT4569	196	CTC20S2UR	247
BS140W	163	BS240-122	161	CC-HCH4572	194	CTC20S2UR	247
BS1854-16SDWL	167	BS240C	152	CC-HDTR4560-27	194	CTC20S3UC	247
BS1854-16SDWR	167	BS242-122	161	CC-HDTR4530-27	195	CTC20S3UL	247
BS1854-16SOS	166	BS2424DCT	164	CC-HDTR4536-27	195	CTC20S3UR	247
BS1854-20SDWL	168	BS2424OCT	164	CC-HDTR4536-29	196	CTC20S4UC	248
BS1854-20SDWR	168	BS2424SCT	164	CC-HDTREC4560-27	194	CTC20S4UR	248
BS1854-20SOSL	168	BS242C	162	CC-HDTREC4572-29	196	CTC20S4UR	248
BS1854-20SOSR	168	BS242L	162	CC-HPT4540-27	195	CTC20S5UC	248
BS1854-20TDSL	173	BS242R	162	CC-MCS4536L	198	CTC20S5UL	248

Index

CTC20S5UR	248	CTL1300CL	220	CTL2305	235	EN22	294
CTC20S6UC	248	CTL1300CR	220	CTL2305UL	238	EN22B	296
CTC20S6UL	248	CTL1301	223	CTL2305UR	238	EN2424-17	286, 447
CTC20S6UR	248	CTL1301CL	230	CTL2305WL	239	EN2424-17B	288
CTC20T2UC	248	CTL1301CR	230	CTL2305WR	239	EN2424-22	286, 447
CTC20T2UL	248	CTL1301U2	233	CTL2306	236	EN2424-22B	288
CTC20T2UR	248	CTL1301UL	225	CTL2306UL	239	EN2448	286, 447
CTC20T2W	249	CTL1301ULCR	232	CTL2306UR	239	EN3030-17	286, 447
CTC20T3UC	249	CTL1301UR	225	CTL2306WL	240	EN3030-17B	288
CTC20T3UL	249	CTL1301URCL	232	CTL2306WR	240	EN3030-22	286, 447
CTC20T3UR	249	CTL1301W2	233	CTL3200	219	EN30R	286, 447
CTC20T3W	249	CTL1301WL	226	CTL3201	242	EN30RB	287
CTC20T4UC	250	CTL1301WLCR	232	CTL3201U2	245	EN36R	286, 447
CTC20T4UL	250	CTL1301WR	226	CTL3201W2	245	EN36RB	287
CTC20T4UR	250	CTL1301WRCL	232	CTL3300	219	EN45	294
CTC20T4W	250	CTL1302	223	CTL3301	243	EN45B	296
CTC20T5UC	250	CTL1302UL	226	CTL3302	243	EN90	295
CTC20T5UL	250	CTL1302UR	226	CTL3303	244	EN90B	296
CTC20T5UR	250	CTL1302WL	226	CTL3304	244	EN90CT	295
CTC20T5W	250	CTL1302WR	226	CTL3305	244	EN9201T-L	283
CTC20T6UC	251	CTL1303	223	CTL3306	244	EN9201T-R	283
CTC20T6UL	251	CTL1303UL	227	CTL4200	220	EN9201U	282
CTC20T6UR	251	CTL1303UR	227	CTL4200CC	221	EN9201UW	282
CTC20T6W	251	CTL1303WL	228	CTL4201	246	EN9201W	283
CTD300	267	CTL1303WR	228	CTL4201U2	246	EN9202U	284
CTD30U	264	CTL1304	224	CTL4201W2	246	EN9202UW	284
CTD30W	266	CTL1304UL	227	CTO32121	256	EN9202W	284
CTD420	268	CTL1304UR	227	CTO32122	257	EN9203U	284
CTD42U	265	CTL1304WL	228	CTO32123	257	EN9203UW	285
CTD42W	266	CTL1304WR	228	CTO32125	257	EN9203W	285
CTD500	268	CTL1305	224	CTO32301	258	EN9210	289
CTD50U	265	CTL1305UL	228	CTO32302	258	EN9211	289
CTD50W	266	CTL1305UR	228	CTO32303	258	EN9212	289
CTI20420	273	CTL1305WL	229	CTO32304	258	EN9213	290
CTI20570	273	CTL1305WR	229	CTO32305	259	EN9214	290
CTI32120	221	CTL1306	224	CTO32306	259	EN9220U-L	292
CTI32121	251	CTL1306UL	229	CTO32451	259	EN9220U-R	292
CTI32122	252	CTL1306UR	229	CTO32452	260	EN9220UW-L	292
CTI32123	252	CTL1306WL	230	CTO32453	260	EN9220UW-R	292
CTI32124	252	CTL1306WR	230	CTO32454	260	EN9220W	294
CTI32125	252	CTL2200	218	CTO32455	261	EN9221U-C	292
CTI32126	253	CTL2200CC	220	CTO32456	261	EN9221UW-C	293
CTI32300	222	CTL2201	234	CTR20500	273	EN9230T-L	294
CTI32301	253	CTL2201U2	240	CTR3210CC	262	EN9230T-R	294
CTI32302	253	CTL2201U2CC	241	CTR3220CC	262	EN9251	282
CTI32303	254	CTL2201W2	240	CTR3220CE	262	EN9710	290
CTI32304	254	CTL2201W2CC	242	CTS320	218	EN9711	291
CTI32305	254	CTL2300	219	CTS32U	263	EN9713	291
CTI32306	254	CTL2300CC	221	CTS32WA	262	ET8028	474
CTI32450	222	CTL2301	234	CTS32WS	262	ETQS8028	474
CTI32451	255	CTL2301U2	240	CTS400	267	FI2028G	302, 454
CTI32452	255	CTL2301U2CC	242	CTS40U	264	FI2028PG	307, 457
CTI32453	255	CTL2301UL	236	CTS40W	266	FI2028PW	308, 458
CTI32454	256	CTL2301UR	236	CTS500	267	FI2028W	303, 455
CTI32455	256	CTL2301W2	241	CTS50U	264	FI2311	299
CTI32456	256	CTL2301W2CC	242	CTS50W	266	FI2312	299
CTL1200	218	CTL2301WL	236	CTW30C	262	FI2313	299
CTL1200CL	220	CTL2301WR	236	CTW45C	262	FI2321	300
CTL1200CR	220	CTL2302	234	CTW900	222	FI2322	300
CTL1201	222	CTL2302UL	236	CTW90U	263	FI2323	300
CTL1201CL	230	CTL2302UR	236	CTW90W	263	FI2331	300
CTL1201CR	230	CTL2302WL	237	DROP12	274, 374	FI2332	301
CTL1201U2	232	CTL2302WR	237	DROP14	274, 374	FI2333	301
CTL1201UL	224	CTL2303	234	DROP24	274	FI2351	305
CTL1201ULCR	231	CTL2303UL	237	EC10	275	FI2352	305
CTL1201UR	224	CTL2303UR	237	EC11	275, 297	FI2353	305
CTL1201URCL	231	CTL2303WL	238	EC12	275, 297	FI2371	306
CTL1201W2	232	CTL2303WR	238	EC21	176, 274	FI2372	306
CTL1201WL	225	CTL2304	235	EC23	374	FI2373	306
CTL1201WLCR	231	CTL2304UL	238	EC24	374	FI2424G	302, 454
CTL1201WR	225	CTL2304UR	238	EC25	374	FI2424PG	307, 457
CTL1201WRCL	231	CTL2304WL	238	EN2142	286, 447	FI2424PW	308, 458
CTL1300	218	CTL2304WR	238	EN2142B	287	FI2424W	303, 455

Index

FI2450G	302, 454	HD9903	327	LA1293.	105	MTL301UAR	339
FI2450PG	307, 457	HD9991	328	LA1294.	105	MTL304.	344
FI2450PW	308, 458	HD9992	328	LA1295.	105	MTL304UAL.	345
FI2450W	303, 455	HD9993	328	LA1301.	103	MTL304UAR	345
FI2460G	302, 454	HN2424-17	320, 462	LA2042MT	106, 464	MTL305.	350
FI2460PG	307, 457	HN3030-17	320, 462	LA2424ET	106, 464	MTL305UAL.	351
FI2460PW	308, 458	HN3636-17	320, 462	LA3030ET	106, 464	MTL305UAR	351
FI2460W	303, 455	HN5301U.	315	LA3636CT	106, 464	MTL306.	348
FI4242G	302, 454	HN5301W	315	LU3030ST	331, 466	MTL306UAL.	349
FI4242PG	307, 457	HN5302BU	317	LU3030SX	331, 466	MTL306UAR	349
FI4242PW	308, 458	HN5302BW.	317	LU30RT.	331, 466	MTL600.	336
FI4242W	303, 455	HN5302U.	316	LU30RX.	331, 466	MTL601.	338
FN1860ST	449	HN5302W	317	LU3636ST	331, 466	MTL601UA	339
FN2028ET	449	HN5311BU	316	LU3636SX	331, 466	MTO220	337
FN2042MT	449	HN5311BW.	316	LU36RT.	331, 466	MTO221	342
FN2424ET	449	HN5311U.	315	LU36RX.	331, 466	MTO221UAL	342
FN2424G-20	450	HN5311W	316	LU721DT	330	MTO221UAR	342
FN2424V-20	450	HN5321U.	321	LU721DX	330	MTO225	350
FN2424X-20	450	HN5321W	321	MA1500F.	42	MTO225UAL	351
FN2448G-17	452	HN5331U.	322	MA1500G	43	MTO225UAR	351
FN2448V-17	452	HN5331W	322	MA1500J.	42	MTO300	337
FN2448X-17	452	HN5332U.	322	MA1500K	43	MTO301	342
FN3636CT	449	HN5332W	322	MA1501F.	108	MTO301UAL	342
FN3636G-17	451	HN53BRKT	325	MA1501G	109	MTO301UAR	342
FN3636V-17	451	HN53C22GL	325	MA1501J.	108	MTO901	343
FN3636X-17	451	HN53C22GT	323	MA1501K	109	MTT1522LTS	353
FN36MTD.	450	HN53C22L	319	MA1530F.	42	MTT1824-58SDL	372
FN42MTD.	450	HN53C22T	318	MA1530G	43	MTT1824-58SDR	372
FO4450	310	HN53C2GL	324	MA1530J.	42	MTT1824-68SDL	373
FO4456	310	HN53C2GT	323	MA1530K	44	MTT1824-68SDR	373
FO4460	310	HN53C2L	319	MA1531F.	108	MTT1848-58SDC	372
FO4466	310	HN53C2T.	318	MA1531G	109	MTT1848-68SDC	373
GL6481C	85	HN53C30GL	325	MA1531J.	108	MTT1848MCW	372
GL6481P	85	HN53C30GT	323	MA1531K	110	MTT2222LTW	353
GT2021LT.	95	HN53C30L	319	MA1533F.	110	MTT2230LTW	353
GT3131CT	95	HN53C30T	318	MA1533G	110	MTT2525LTC	353
GT4901D	87	HN53C45GL	325	MA1533J.	110	MTT4842-39MAWB	368
GT4901E	87	HN53C45GT	323	MA1533K	111	MTT4842-39MAWW	370
GT4901F	87	HN53C45L	319	MA1561F.	111	MTT4848-39MAWB	368
GT4901G	88	HN53C45T	318	MA1561J.	111	MTT4848-39MAWW	370
GT4901I	88	HN53CLGRT	323	MA1563F.	112	MTT4854-28MAWB ▲	364
GT4901J	88	HN53CLGSL	324	MA1563J.	112	MTT4854-28MAWW ▲	366
GT4951D	94	HN53CLGST	323	MTI220.	337	MTT4854-39MACB	360
GT4951E	94	HN53CLRT	318	MTI221.	340	MTT4854-39MACW	362
GT4952D	94	HN53CLSL	319	MTI221UAL.	341	MTT4854-39MAWB	368
GT4952E	94	HN53CLST	318	MTI221UAR.	341	MTT4854-39MAWW	370
GT4992D	88	HN53CTGL	324	MTI224.	346	MTT4860-28MAWB ▲	364
GT4992E	89	HN53CTGT	323	MTI224UAL	347	MTT4860-28MAWW ▲	366
GT4992F	89	HN53CTL	319	MTI224UAR.	347	MTT4860-39MACB	360
GT4992G	89	HN53CTT	318	MTI226.	348	MTT4860-39MACW	362
GT4992I	90	HN53CXGL	324	MTI226UAL	349	MTT4860-39MAWB	368
GT4992J	90	HN53CXGT	323	MTI226UAR.	349	MTT4860-39MAWW	370
GT4993D	90	HN53CXL	319	MTI300.	336	MTT4866-28MACB ▲	356
GT4993E	90	HN53CXT	318	MTI301.	340	MTT4866-28MACW ▲	358
GT4993F	91	HN53E2GL	324	MTI301UAL	341	MTT4866-28MAWB ▲	364
GT4993G	91	HN53E2GT	323	MTI301UAR.	341	MTT4866-28MAWW ▲	366
GT4993I	91	HN53E2L	319	MTI304.	346	MTT4866-39MACB	360
GT4993J	92	HN53E2T.	318	MTI304UAL	347	MTT4866-39MACW	362
GT4994D	92	KE6551D.	99	MTI304UAR	347	MTT4866-39MAWB	369
GT4994E	92	KE6561C.	99	MTI306.	348	MTT4866-39MAWW	371
GT4994F	92	KE6571C.	99	MTI306UAL	349	MTT4872-28MACB ▲	356
GT4994G	93	KE6581D.	100	MTI306UAR.	349	MTT4872-28MACW ▲	358
GT4994I	93	KE6591C.	100	MTI901.	343	MTT4872-28MAWB ▲	365
GT4994J	93	LA1281.	102	MTL260.	336	MTT4872-28MAWW ▲	367
GT49BRKT	95	LA1281B.	102	MTL261.	338	MTT4872-39MACB	360
HB2900	40	LA1282.	102	MTL261UAL.	339	MTT4872-39MACW	362
HB2901	97	LA1282B.	102	MTL261UAR	339	MTT4872-39MAWB	369
HB2905	40	LA1283.	103	MTL264.	344	MTT4872-39MAWW	371
HB2911	313	LA1284.	103	MTL264UAL.	345	MTT4878-28MACB ▲	357
HB2912	313	LA1285.	104	MTL264UAR	345	MTT4878-28MACW ▲	358
HB2913	313	LA1286.	104	MTL300.	336	MTT4878-39MACB	361
HD9901	327	LA1287.	104	MTL301.	338	MTT4878-39MACW	363
HD9902	327	LA1292.	104	MTL301UAL.	339	MTT4884-28MACB ▲	357

Index

MTT4884-28MACW ▲	359	MTVP26ROUN.	354	ORT4424-22	311,460	S07370	394
MTT4884-39MACB	361	MTVP26SQCL	354	ORT4520M-24	192,443	S07380	394
MTT4884-39MACW	363	MTVP26TRI	354	ORT4536M-17	192,443	ST8028.	474
MTV1522DTS	352	MTVP30ROUN.	354	ORTL4530-18.	193	STQS8028	474
MTV1522LTS	353	NW5100	46	ORTL4536-18.	193	TA6070B	.67
MTV1824-58SDL	372	NW5110	46	ORWT6630-26	419	TA6070P	.66
MTV1824-58SDR	372	NW5120	46	OST4518-24	181,441	TA6070S	.66
MTV1824-68SDL	373	NW5121	46	OST4520M-24	192,443	TA6075B	.64
MTV1824-68SDR	373	NW5130	47	OST4524-24	181,441	TA6075P	.63
MTV1848-58SDC	372	NW5140	47	OST6615-26	420	TA6075S	.64
MTV1848-68SDC	373	NW5151	47	OST7322-24	396,472	TA6080B	.66
MTV1848MCW	372	OCFT4436-15	311,460	OVTL4560-18.	193	TA6080P	.65
MTV2222DTW	352	OCFT4530-17	181,441	PO9012	.49	TA6080S	.65
MTV2222LTW	353	OCFT4530M-16.	192,443	PO9013	.49	TA6081B	126
MTV2230DTW	352	OCFT4536-17	181,441	PO9016	.49	TA6081P	126
MTV2230LTW	353	OCFT4542M-18.	192,443	PO9022	.50	TA6081S	126
MTV2525DTC	352	OCFT4548-17	181,441	PO9023	.50	TA6085B	.63
MTV2525LTC	353	OCFT6630-18	419,476	PO9026	.50	TA6085P	.62
MTV4842-39MAWB	368	OCFT6648-18	419,476	PO9030	114	TA6085S	.63
MTV4842-39MAWW	370	OCFT7330-16	396,472	PO9050	114	TA6090B	.65
MTV4848-39MAWB	368	OCFT7336-16	396,472	PO9060	391	TA6090P	.64
MTV4848-39MAWW	370	OCFT7342-16	396,472	PO9065	392	TA6090S	.64
MTV4854-28MAWB ▲	364	OCST4548M-30	192,443	PO9070	391	TA6095B	.62
MTV4854-28MAWW ▲	366	OCST4560-29	181,441	PO9075	392	TA6095P	.62
MTV4854-39MACB	360	OCST7348-29	396,472	PO9080	391	TA6095S	.62
MTV4854-39MACW	362	OET4524-24	181,441	PO9085	392	TM17R	128
MTV4854-39MAWB	368	OET7330-24	396,472	PR6631C	116	TM24R	128
MTV4854-39MAWW	370	OL2828-17	381,468	PR6631F	116	TY8600	.69
MTV4860-28MAWB ▲	364	OL3636-17	381,468	PR6631O	116	TY8610L	.69
MTV4860-28MAWW ▲	366	OL7601U	377	PT5600	.52	TY8610T	.69
MTV4860-39MACB	360	OL7601W	377	PT5600T	.52	TY8620	.70
MTV4860-39MACW	362	OL7602U	377	PT5600U	.53	TY8630L	.70
MTV4860-39MAWB	368	OL7602W	378	PT5605T	.54	TY8630T	.70
MTV4860-39MAWW	370	OL7603U	378	PT5605U	.54	WA4013	.72
MTV4866-28MACB ▲	356	OL7603W	378	PT5610	.52	WA4018	.72
MTV4866-28MACW ▲	358	OL7604	378	PT5610T	.52	WA4023	.72
MTV4866-28MAWB ▲	364	OL7605	380	PT5610U	.53	WA4028	.73
MTV4866-28MAWW ▲	366	OL7606	380	PT5615T	.53	WA8060	130
MTV4866-39MACB	360	OL7607	379	PT5615U	.54	ZV6628	415
MTV4866-39MACW	362	OL7608	379	PT5650	.55	ZV6628-FB	412
MTV4866-39MAWB	369	OL7610	380	PT5650T	.55	ZV6636	417
MTV4866-39MAWW	371	OL7821U	382	PT5650U	.56	ZV6642	417
MTV4872-28MACB ▲	356	OL7821W	382	PT5655T	.56	ZV6647	416
MTV4872-28MACW ▲	358	OL7822BU	383	PT5655U	.57	ZV6648	417
MTV4872-28MAWB ▲	365	OL7822BW	383	PT5660	.54	ZV6650-OB	412
MTV4872-28MAWW ▲	367	OL7822U	382	PT5660T	.55	ZV6651-IB	414
MTV4872-39MACB	360	OL7822W	382	PT5660U	.56	ZV6655	415
MTV4872-39MACW	362	OL7823BU	384	PT5665T	.56	ZV6655-FB	412
MTV4872-39MAWB	369	OL7823BW	384	PT5665U	.57	ZV6660	408
MTV4872-39MAWW	371	OL7823U	383	PX800	.59	ZV6660-PS	410
MTV4878-28MACB ▲	357	OL7823W	384	PX800L	.59	ZV6665	408
MTV4878-28MACW ▲	358	OL7832U	384	PX800T	.60	ZV6670	408
MTV4878-39MACB	361	OL7832W	385	PX810	.59	ZV6670-PS	410
MTV4878-39MACW	363	OL7843U	385	PX810L	.60	ZV6672-PS	410
MTV4884-28MACB ▲	357	OL7843W	385	PX810T	.60	ZV6675	409
MTV4884-28MACW ▲	359	OL7891U	386	RI2571	118	ZV6680	408
MTV4884-39MACB	361	OL7891W	386	SA1061C	122	ZV6683	416
MTV4884-39MACW	363	OL7892U	386	SA1061D	122	ZV6683-FB	412
MTVF36ROUN.	355	OL7892W	386	SA1061E	122	ZV6685	409
MTVF36SQCL	355	OL7893U	387	SH1860ST	470	ZV6688	416
MTVF36TRI	355	OL7893W	387	SH2028ET	470	ZV6688-FIB	414
MTVF42ROUN.	355	OL78C	388	SH2042MT	470	ZV6688-FIB-2A	411
MTVF42SQCL	355	OL78C2	388	SH2424ET	470	ZV6688-FIB-LA	414
MTVF42TRI	355	OL78C22	389	SH36MTD.	470	ZV6688-FIB-RA	414
MTVF48ROUN.	355	OL78C30	389	SH42MTD.	470	ZV6688-FOB	413
MTVF48SQCL	355	OL78C45	389	SL3101D	124	ZV6688-FOB-2A	411
MTVF48TRI	355	OL78CL	388	SL3103D	124	ZV6688-FOB-LA	413
MTVF54ROUN.	355	OL78CT	388	S07330	395	ZV6688-FOB-RA	413
MTVF54SQCL	355	OL78CX	389	S07335	120	ZV6688-LIB	414
MTVF54TRI	355	OL78E2	388	S07336	395	ZV6688-LOB	413
MTVP22ROUN.	354	ORCT6648-24-18.	419,476	S07348	395	ZV6688-RIB	414
MTVP22SQCL	354	ORET6624-12-26.	420	S07360	394	ZV6688-ROB	413
MTVP22TRI	354	ORT4424-15	311,460	S07361	394		